

U.S. Department  
of Transportation

United States  
Coast Guard



---

# CELESTIAL NAVIGATION

U. S. Coast Guard  
Pamphlet No. D46302  
(05/86)

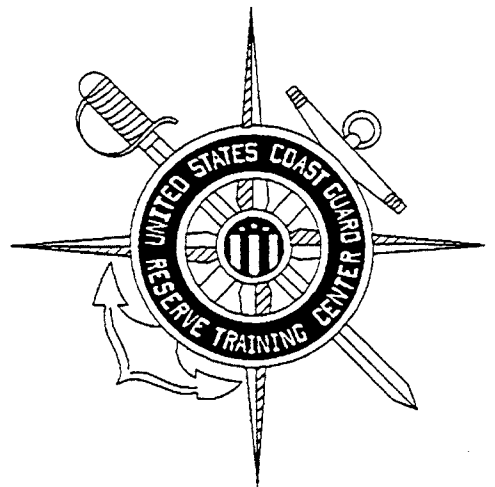

# CELESTIAL NAVIGATION

CREATION DATE: February 1984  
REVISION DATE:  
Review/Reprint Date: February 1988

U.S. Coast Guard  
Reserve Training Center (t-nro)  
Yorktown, VA 23690-5000

FTS: 827-2233  
Commercial: (804) 898-2233

QUESTIONS ABOUT THIS TEXT SHOULD BE  
ADDRESSED TO THE SUBJECT MATTER SPECIALIST  
FOR THE QUARTERMASTER RATING.

## REFERENCES

American Practical Navigator	Pub 9 Vol 1
A Navigation Compendium	NAVTRA 10494-A
Quartermaster 3 & 2	NAVEDTRA 10149-F1
Quartermaster 1 & C	NAVTRA 10151-D
The Nautical Almanac	
Sight Reduction Tables for Marine Navigation	Pub 229

## NOTICE TO STUDENT

The primary purpose of this pamphlet is to provide enough knowledge for you to correctly observe and plot celestial lines of position, and to obtain any information needed to complete a celestial navigational day at sea. The degree of proficiency you can actually reach in celestial navigation will require experience. However, if you use the knowledge you acquire here as a foundation, it should make the art of celestial navigation a more satisfying experience.

**IMPORTANT NOTE:** This text has been compiled for TRAINING only. It should NOT be used in place of official directives or publications. The text information is current according to the references listed. You should, however, remember that it is YOUR responsibility to keep up with the latest professional information available for your rate or grade.

Each assignment is divided into three parts:

- Reading assignment and objectives.
- Reading material.
- Self-quiz with answers and references.



## CONTENTS

TITLE	PAGE
REFERENCES	ii
NOTICE TO STUDENTS	iii
Assignment 1	
INTRODUCTION TO CELESTIAL NAVIGATION	1-1
Assignment 2	
TIME	2-1
Assignment 3	
MARINE SEXTANT/RUDE STARFINDER	3-1
Assignment 4	
CELESTIAL FIX	4-1
Assignment 5	
TWILIGHT AND OTHER PHENOMENON	5-1
Assignment 6	
AZIMUTHS OF CELESTIAL BODIES	6-1
Assignment 7	
DETERMINATION OF LATITUDE	7-1
Assignment 8	
ALTITUDE-INTERCEPT METHOD	8-1
Assignment 9	
CELESTIAL OBSERVATIONS	9-1
Appendix A	
THE NAUTICAL ALMANAC (EXTRACTS)	A-1
Appendix B	
SIGHT REDUCTION FOR MARINE NAVIGATION (EXTRACTS)	B-1
Appendix C	
BLANK SIGHT FORMS	C-1

## INTRODUCTION TO CELESTIAL NAVIGATION

Reading Assignment: 1  
Pages 1-1 through 1-10

### OBJECTIVES

To successfully complete this assignment, you must study the text and master the following objectives:

1. Define the magnitude of a celestial body and specify the system by which magnitudes are assigned to celestial bodies.
2. Describe the earth's relationship to the other bodies of the solar system.
3. Define the elements of the terrestrial, celestial, and horizon systems of coordinates.
4. Define the elements of the celestial and navigational triangles.

### CELESTIAL NAVIGATION

The art of celestial navigation is an ancient art as old as civilization itself. When man became adventurous, a guide was needed to assist the mariner in travels around the world.

For centuries, the mariner used the big and little dippers as guides because they always stayed in the same relative position in the sky. There was one star in the sky that never seemed to move during the course of the night. This star was called several names, but we now know it as POLARIS (the Pole Star). The mariner noticed that by keeping Polaris at a constant altitude above the horizon, man could sail east and west to a destination. By changing the altitude of Polaris, man could also move north and south. The mariner was unknowingly determining various latitudes by observing the altitude of Polaris. By using the Star Polaris, man was able to "latitude" sail all over the world.

With the advent of good methods of determining time, the mariner was able to determine longitude as well as latitude. With the use of an octant (and later a sextant), the mariner was able to identify and observe various stars and compute their position relative to them.

The early navigator had to be a mathematician with a full knowledge of astronomy because solving for the longitude required solving of a spherical triangle. Today's navigator no longer needs to be either a mathematician or astronomer because all of the spherical trigonometry is computed in tables which you will use in this course.

Celestial navigation is not a dead art as some would like to think in this age of electronics. To the contrary, it is used as a means of updating electronic navigation systems and is used on the high seas exclusively when other means are not available.

### ASTRONOMY

Celestial navigation is dependent upon certain principles of astronomy, particularly as the latter relates to the positions, magnitudes, and motions of celestial bodies. Astronomy is considered to be the oldest of the sciences. The term "astronomy" is derived from the compounding of two Greek words, "astron" meaning a star or constellation, and "nomos" or law, and is translated literally as the "law of the stars." Ordinarily, it is defined as the science which treats of the heavenly bodies. It is indeed a science of great antiquity.

Three great systems of astronomy have evolved. The Ptolemaic system, now considered as hypothesis, was originated by the Alexandrian astronomer Ptolemy in the second century A.D. Ptolemy placed the earth at rest in the center of the universe, with the moon, Mercury, Venus, the sun, Mars, Jupiter and Saturn revolving about it. The second system, also an hypothesis, was originated by Tycho Brahe in the sixteenth century. Brahe had tried to reconcile astronomy with a literal translation of Scripture, and in so doing, developed a new concept of the solar system. In the Brahean system, the earth is at rest with the sun and the moon revolving about it; the other planets are considered to be revolving about the sun. The third system, which actually antedated that of Tycho Brahe, was conceived earlier in the sixteenth century by the mathematician and astronomer Nicolaus Copernicus. The Copernican theory, now universally adopted as the true solar system, places the sun at the center, with primary planets, including the earth, revolving about the sun from west to east. The earth is considered to be turning on its axis, and the moon is revolving about the earth. Other secondary planets revolve about their primaries. Beyond the solar system, fixed stars serve as centers to other systems. The Copernican concept is the basis of modern astronomy. Further refinements have been made by noted astronomers such as Johann Kepler. Through Kepler's work, which followed that of Tycho Brahe, the true nature of planetary orbits was realized.

With this brief introduction to astronomy, that portion with nautical significance is further considered. Predicted positions of celestial bodies will be compared with observed positions. Such comparisons provide the basis for celestial lines of position.

## UNIVERSE IN MOTION

Motion in the universe is viewed as actual and apparent. We will commence our study by considering the actual motion of (a) the earth, (b) the sun, (c) the planets, (d) the moon, and (e) the stars and galaxies.

a. The earth, the platform from which we observe the universe, engages in four principal motions as follows:

1. Rotation. The earth rotates once each day about its axis, from west to east. The period of rotation is the basis of the calendar day. We can prove the direction of rotation by observing the flow of water from an ordinary wash basin filled with water. When the stopper is removed and the water is allowed to run down the drain, the water will spiral clockwise in the southern hemisphere and counterclockwise in the northern hemisphere. The reason for this action by the water is that two forces are acting upon it. First, gravity acts to cause the water to flow down the drain. Secondly, the rotation to the earth, a force that is considered to be concentrated at the earth's equator, acts upon the column of water causing spiral motion, the direction of the spiral depending upon which side of the concentrated force the water column happens to be located.

2. Revolution. The earth revolves about the sun once each year (365 1/4 days), from west to east. The period of revolution is the basis of the calendar year. The difference between rotation and revolution is that rotation is commonly used to refer to turning on an axis while revolution usually refers to travel in an orbit. The actual length of time required for the earth to complete one revolution is a little less than 365 1/4 days and, therefore, the establishment of an accurate calendar has been a problem. The Gregorian calendar, which replaced that of Julius Caesar, practically eliminated the discrepancy by the elimination of 3 leap years (3 days) per 400 years. This was accomplished by eliminating leap years on turns of the century not divisible by 400. For example, the years 1700, 1800, and 1900 were 365 days in length, while the year 2000 will be 366 days (leap year) in length. Although the calendar of Pope Gregory leaves something to be desired, its error is only 3 days in 10,000 years.

The earth's orbit is elliptical. During the winter months in the Northern Hemisphere, the earth travels nearer the sun, thus making the sun appear wider in diameter at that time. Also, due to the sun's proximity, the relative speed of the earth as compared to that of the sun is greater in winter than during the summer months in the Northern Hemisphere, resulting in northern winters being 7 days shorter than northern summers,

and southern winters being 7 days longer than southern summers. The average speed of the earth in its orbit is 18 1/2 miles per second.

3. Precession. The earth precesses about an ecliptic axis (i.e., a line passing through the earth's center perpendicular to the plane of the earth's orbit) once each 25,800 years in a counterclockwise direction. This motion is analogous to the motion sometimes observed in a spinning top. When a top is spun, two forces act: (1) the spinning force which tends to keep the top upright, and (2) the force of gravity which tends to pull the top from an upright position. The result of these two forces is precession, which is the conical motion of an axis around a perpendicular to the plane upon which it is spun. The earth has a spinning motion of rotation about its axis, which is not perpendicular to the plane of its orbit, and it is acted upon by the gravitational forces of attraction of the moon and the sun; these gravitational torques tend to align the earth's axis with the ecliptic axis. The result to the earth's precession is a difference in location of the stars in our heavens with respect to our north pole. At present, Polaris (north star) is almost directly above the north pole of the earth. In years to come, a vertical line through our North Pole will point to other stars. It will point in the direction of Deneb in the year 10,000 and in the direction of Vega in 14,000. Again, in the year 27,900 Polaris will be above our North Pole.

4. Space Motion. The earth and the other members of our solar system are moving through space in the direction of the star Vega at a speed of about 12 miles per second.

b. The sun, the center of our solar system, rotates upon its axis, which is inclined 7 degrees to its path of travel, and travels through space as does the earth.

c. The planets of our solar system rotate upon their axes from west to east, revolve about the sun from west to east in ellipses of small eccentricity, and engage in space motion.

d. The moon, a secondary planet, rotates upon its axes from west to east, revolves about the earth from west to east

once in 29 1/2 solar days, and joins other members of our solar system in space motion. The period of rotation of the moon upon its axis, the rotation of the earth, is so synchronized that from the earth we see but one side of the moon.

e. The stars engage in space motion and also rotation as does the sun. They are arranged in groups called galaxies. Our galaxy, the Milky Way, contains possibly 100 billion stars. The universe may contain 100 million galaxies, all of which have space motion independent of, and more significant than, the space motion of our solar system. The stars are considered to be an infinite distance from the earth.

A notable observation in the case of actual motion is that most bodies of the universe rotate from west to east, travel from west to east in their orbits, and according to some theories, behave in general as electrons in the structure of the atom.

The astronomer studies actual motion; the navigator is concerned with apparent motion. The navigator stops the earth, so to speak, and observes the celestial bodies rise in the east, travel westward, and set in the west. The astronomer tabulates information which the navigator uses to fix the position.

### CELESTIAL SPHERE CONCEPT

Because of the necessity for location of celestial bodies in the heavens, we use a system of coordinates similar to latitude and longitude on the surface of the earth. The system established is known as the celestial sphere concept. The following terms constitute the concept:

**CELESTIAL SPHERE** - A sphere of infinite radius with the earth as center. Whenever convenient we think of the earth as a point, and as a point it has no magnitude. We portray all of the heavenly bodies on the surface of the celestial sphere. We consider apparent rather than actual motion, and thus actual distances are immaterial. (See figure 1-1.)

**CELESTIAL POLES** - Points on the surface of the celestial sphere which mark the point of intersection of the celestial sphere and the

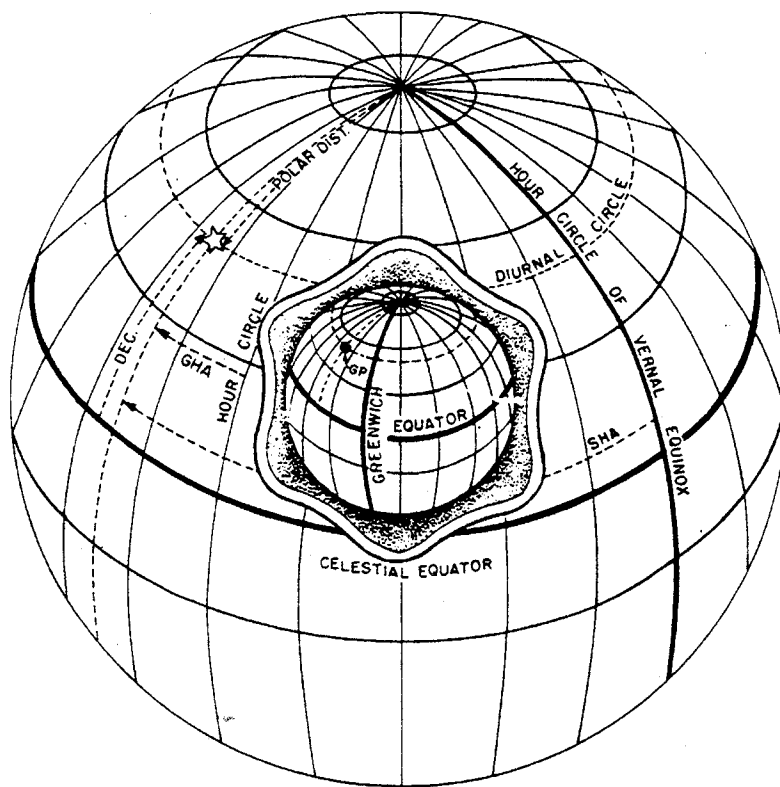

Figure 1-1-The celestial sphere

earth's axis extended. The north celestial pole is abbreviated Pn and the south celestial pole is abbreviated Ps.

**ELEVATED POLE** - The celestial pole which corresponds in name to the observer's latitude.

**EQUINOCTIAL** - A great circle on the surface of the celestial sphere everywhere 90 degrees from the celestial poles. Sometimes called the **CELESTIAL EQUATOR**, the equinoctial lies in a plane which is the plane of the equator extended to intersect the celestial sphere and which is perpendicular to the axis of the earth (and of the celestial sphere). The equinoctial, like the equator, supplies a reference for north-south measurement.

**CELESTIAL MERIDIAN** - A great circle on the surface of the celestial sphere which passes through the celestial poles and over a given position on earth. There are an infinite number of celestial meridians. Each meridian has an upper branch (180 degrees of arc passing over a position and terminating at the celestial poles) and a lower branch (remaining 180 degrees of arc). In common usage, the term "celestial meridian" refers to the upper branch.

**HOURLY CIRCLE** - A half of a great circle on the surface of the celestial sphere which passes through a celestial body and terminates at the celestial poles. The hour circle, contrasted to the celestial meridian, moves with the celestial body progressively with time from east to west (since we consider apparent motion), while the position of the celestial meridian remains fixed. With knowledge of the earth's rotation (one turn upon its axis per 24 hours), we can realize that each celestial body crosses our meridian once each 24 hours. Dividing 360 degrees (number of degrees in a circle) by 24 hours, we find that an hour circle advances about 15 degrees per hour.

**DECLINATION** - The angular distance of a body north or south of the equinoctial measured along the hour circle. Declination resembles latitude and like latitude must be labeled north or south. Declination is abbreviated "dec."

**GREENWICH HOUR ANGLE (GHA)** - The angle between the celestial meridian of Greenwich, England, and the hour circle of a body, measured westward along the arc of the equinoctial, and expressed in degrees from 0 to 360. Also equal to the angle at the celestial pole between the Greenwich celestial meridian and the hour circle, measured westward.

**LOCAL HOUR ANGLE (LHA)** - The angle between the celestial meridian of the observer and the hour circle of a body, measured westward along the arc of the equinoctial, and expressed in degrees from 0 to 360. Also equal to the angle at the celestial pole between the local celestial meridian and the hour circle, measured westward. In west longitude LHA is found by subtracting the longitude of the observer from the GHA. In east longitude LHA is found by adding the longitude of the observer to the GHA.

**ECLIPTIC** - The apparent path of the sun among the stars over a period of a year; a great circle on the surface of the celestial sphere lying in a plane which intersects the plane of the equinoctial making an angle of approximately 23 1/2 degrees.

**ZODIAC** - A belt extending 8 degrees to each side of the ecliptic. The apparent paths of all the planets within our solar system fall within this belt except for Venus which occasionally appears to travel outside the zodiac. The zodiac was divided into 12 sectors (signs) by the ancients to correspond to months, each sector being named for the constellation which the sun appeared to be passing through or near at that time. Each sector or sign extends 30 degrees in arc.

**EQUINOXES** - Two great circles on a spherical surface share two points of intersection. The points of intersection of the equinoctial and the ecliptic are called the vernal equinox (March equinox) and the autumnal equinox. The sun normally arrives at the vernal equinox on March 21; at that time (the beginning of spring), the declination of the sun is 0 and the sun passes from south to north declination. The sun normally arrives at the autumnal equinox on September 23; at that time (the beginning of autumn), the declination is also 0 and the sun passes from north to south declination.

**SOLSTICES** - When the sun reaches its maximum northern declination ( $23\ 1/2$  N) on or about June 22, we speak of the time as the summer solstice (the beginning of summer). When the sun reaches its maximum southern declination ( $23\ 1/2$  S) on or about December 22, we speak of the time as the winter solstice (the beginning of winter).

**DIURNAL CIRCLE** - A small circle on the surface of the celestial sphere which describes the apparent daily path of a celestial body. The diurnal circle of the sun at the summer solstice projected to the earth is called Tropic of Cancer which is located  $23\ 1/2$  degrees north of the equator. The Tropic of Cancer is named for the sign of the zodiac containing the sun at the time, and it marks the northern limit of the tropics. The diurnal circle of the sun at the winter solstice projected to the earth is called the Tropic of Capricorn which is located  $23\ 1/2$  degrees south of the equator. Tropic of Capricorn is named for the sign of the zodiac containing the sun at the time, and it marks the southern limit of tropics. When the sun is over the Tropic of Cancer (summer solstice), its rays extend 90 degrees to either side causing continual daylight (midnight sun) in the region north of  $66\ 1/2$  degrees North Latitude, and continual darkness in the region south of  $66\ 1/2$  degrees South Latitude. When the sun is over the Tropic of Capricorn, the region north of  $66\ 1/2$  degrees North Latitude has continual darkness and the region south of  $66\ 1/2$  degrees South Latitude has continual daylight. This is the basis for our establishment of the Arctic and Antarctic Circles.

**FIRST POINT OF ARIES** - Abbreviated by (the ram's horns or the Greek letter upsilon), the first point of Aries is a reference point on the ecliptic and is another name for the vernal or March equinox. Although it is an imaginary point, we may establish an hour circle through it for measurement of sidereal hour angle and right ascension.

**SIDEREAL HOUR ANGLE (SHA)** - The angle between the hour circle of the first point of Aries and the hour circle of a body measured westward along the arc of the equinoctial, expressed in degrees from 0 to 360. The word "sidereal" normally means "of or pertaining

to stars" and the SHA for navigational stars is tabulated in the Nautical Almanac. SHA, unlike the other hour angles, does not increase with time but remains relatively constant. The reason for this is that the hour circles between which the measurement is made are traveling at practically the same speed, and thus have a relative speed of nearly zero.

**RIGHT ASCENSION** - The angle between the hour circle of the first point of Aries and the hour circle of a body, measured eastward along the arc of the equinoctial, and expressed in either degrees or in hours. Right ascension (in degrees) plus sidereal hour angle equals 360 degrees.

**TRANSIT** - The passage of a body across a meridian. The crossing of the upper branch of the celestial meridian is the "upper transit"; the crossing of the lower branch is the "lower transit."

**CULMINATION** - A synonym of "upper transit."

**MERIDIAN ANGLE (t)** - The angle between the celestial meridian of the observer and the hour circle of a body measured eastward or westward along the arc of the equinoctial from the celestial meridian, and expressed in degrees from 0 to 180. Meridian angle always carries a suffix "E" or "W" to indicate direction of measurement. When LHA is less than 180 degrees, t equals LHA, and is labeled west. When LHA is greater than 180 degrees, t equals  $360 - \text{LHA}$ , and is labeled east.

**POLAR DISTANCE** - The angular distance of a body from the elevated pole measured along the hour circle. When declination and elevated pole are of the same name (both north or both south), polar distance is the complement of declination and may be referred to as co-dec. When elevated pole and declination are of different names (one north and one south), polar distance equals 90 degrees plus declination.

#### HORIZON SYSTEM OF COORDINATES

Location of points on the celestial sphere by declination and hour angle is not always practical for an observer, since the equinoctial is an imaginary circle. For the observer, the

horizon offers a better reference. The horizon system employs the following terms:

**ZENITH** - Point on the celestial sphere directly above the observer. Abbreviated "Z."  
A point on the surface of the earth having a star in its zenith is called the star's geographic position, sub-astral, or ground point.

**NADIR** - Point on the celestial sphere directly below the observer. Abbreviated "Na."

**CELESTIAL HORIZON** - A great circle on the surface of the celestial sphere everywhere 90 degrees from the zenith. The visual horizon is the line at which the earth appears to meet the sky. If a plane is passed through the observer's position and perpendicular to the zenith-nadir axis we have the sensible horizon. The visual horizon is corrected to the sensible horizon by application of a correction for height of observer's eye. If a plane is passed through the center of the earth perpendicular to the zenith-nadir axis, we have the rational horizon. When projected to the celestial sphere, both the sensible and the rational horizon meet at the celestial horizon. This occurs because the planes of the sensible and rational horizons are parallel and parallel lines meet at infinity (the radius of the celestial sphere).

**VERTICAL CIRCLE** - A great circle on the surface of the celestial sphere passing through the zenith and nadir and through some celestial body. Although it is by definition a complete circle, in actual usage we speak of the 180 degrees through the body and terminating at the zenith and nadir respectively, as the vertical circle. In practice we make use of the 90 degree arc from the zenith to the horizon through the body; the remaining 90 degrees below the horizon is not visible and serves no purpose.

**PRIME VERTICAL** - A vertical circle passing through the east and west points of the horizon. The prime vertical arc above the horizon terminates at the points of intersection of the equinoctial and the celestial horizon.

**ALTITUDE (h)** - The angular distance of a body above the horizon measured along the vertical circle.

**ZENITH DISTANCE** - The angular distance of a body from the zenith measured along the vertical circle; it is the complement of the altitude and is abbreviated either "z" or "co-alt."

**AZIMUTH (Zn)** - The true direction of a celestial body; the angle between the celestial meridian and the vertical circle measured right or clockwise from north to the vertical circle.

**AZIMUTH ANGLE (Z)** - The angle between the local celestial meridian and the vertical circle; the arc of the horizon measured from either the north or south points of the horizon (depending upon which pole is elevated) right or left to the vertical circle and expressed in degrees from 0 to 180. Azimuth angle must be prefixed by N or S to indicate which is the elevated pole, and suffixed by E or W to indicate the direction of measurement. If meridian angle is east, the suffix will be "E"; if meridian angle is west, the suffix will be "W."

We may establish certain relationships between azimuth and azimuth angle (figure 1-2) as follows:

a. When azimuth angle is measured north to east (north pole elevated, east meridian angle), azimuth equals azimuth angle.

b. When azimuth angle is measured north to west (north pole elevated, west meridian angle), azimuth equals the complement of, or 360 minus, the azimuth angle.

c. When azimuth angle is measured south to east (south pole elevated, east meridian angle), azimuth equals the supplement of azimuth angle.

d. When azimuth angle is measured south to west (south pole elevated, west meridian angle), azimuth equals 180 degrees plus azimuth angle.

**LATITUDE OF THE OBSERVER** - This value is projected on the celestial sphere as the angular distance between the equinoctial and the zenith, measured along the celestial meridian.



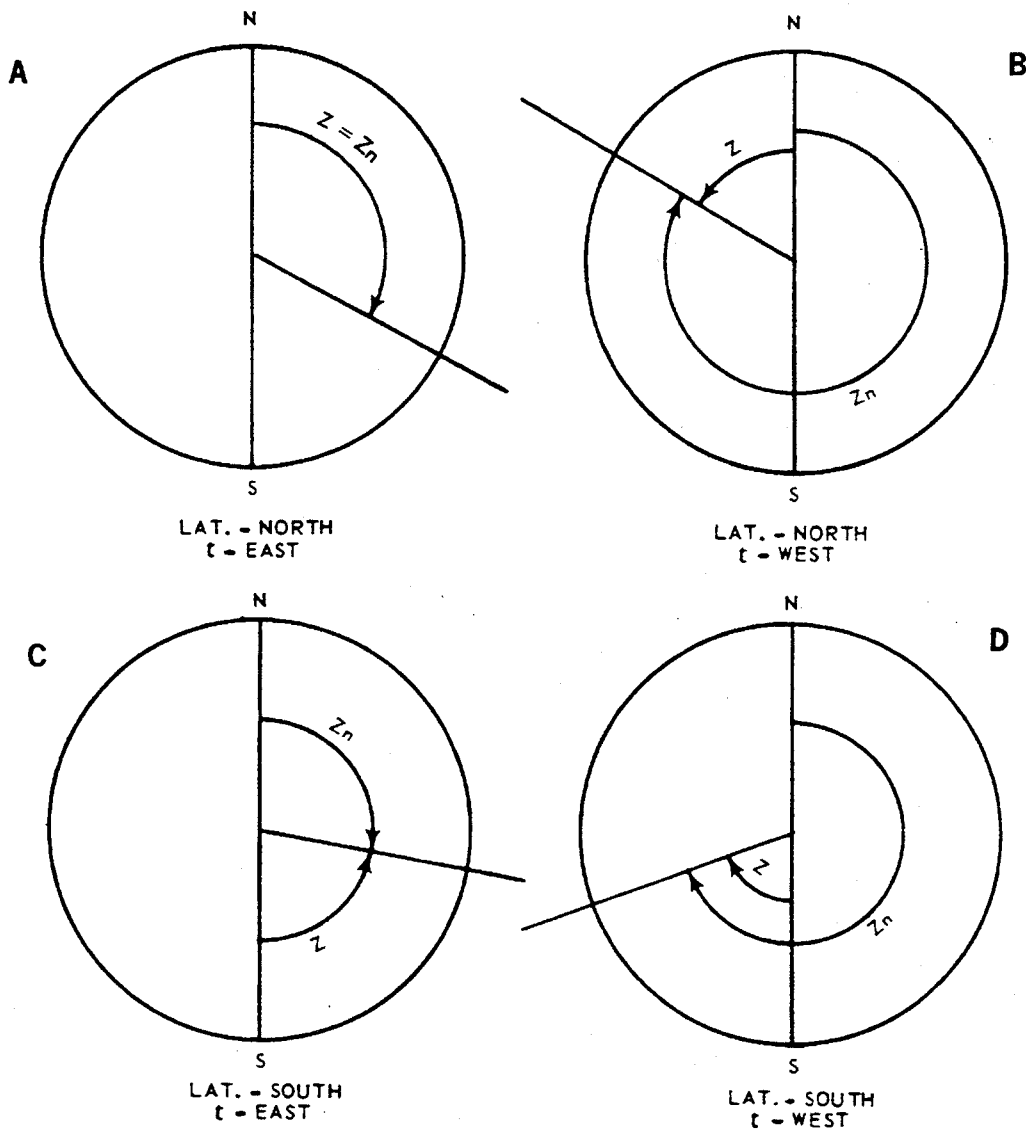

Figure 1-2 - Azimuth angles and azimuth.

**POLAR DISTANCE OF THE ZENITH** - The angular distance between the zenith and the elevated pole measured along the celestial meridian. The complement of the latitude and usually referred to as "co-lat." (See figure 1-4 for the comparison of elements.)

### ASTRONOMICAL TRIANGLE

Combining the celestial sphere concept and the horizon system of coordinates (figure 1-3A), we derive a triangle on the surface of the celestial sphere known as the astronomical triangle (figure 1-3B). This triangle projected back to the earth's surface is the navigational triangle. In practice, the terms astronomical and navigational as applied to triangles are synonymous.

In the astronomical (or navigational) triangle as illustrated, two sides and the included angle are given (co-lat,  $t$ , co-dec)

and the opposite side (co-alt) and one angle ( $Z$ ) are solved for. Actually, latitude of the observer and co-lat are not known exactly, but are assumed, as is longitude in arriving at " $t$ ." The actual altitude is measured, and, by its comparison with the computed altitude, the discrepancy in the assumptions of latitude and longitude may be determined.

Solution of the astronomical triangle may be accomplished using the cosine-haversine law. However, practical navigators no longer resort to spherical trigonometry for the solution of the triangle. Instead they make use of such tables as H.O. 229 which actually are tabulations of the results of solutions of all possible triangles. In preparing these tables, it was customary to break the astronomical triangle into two right spherical triangles by dropping a perpendicular from one vertex to the opposite side. For convenience, these tables are so tabulated as to

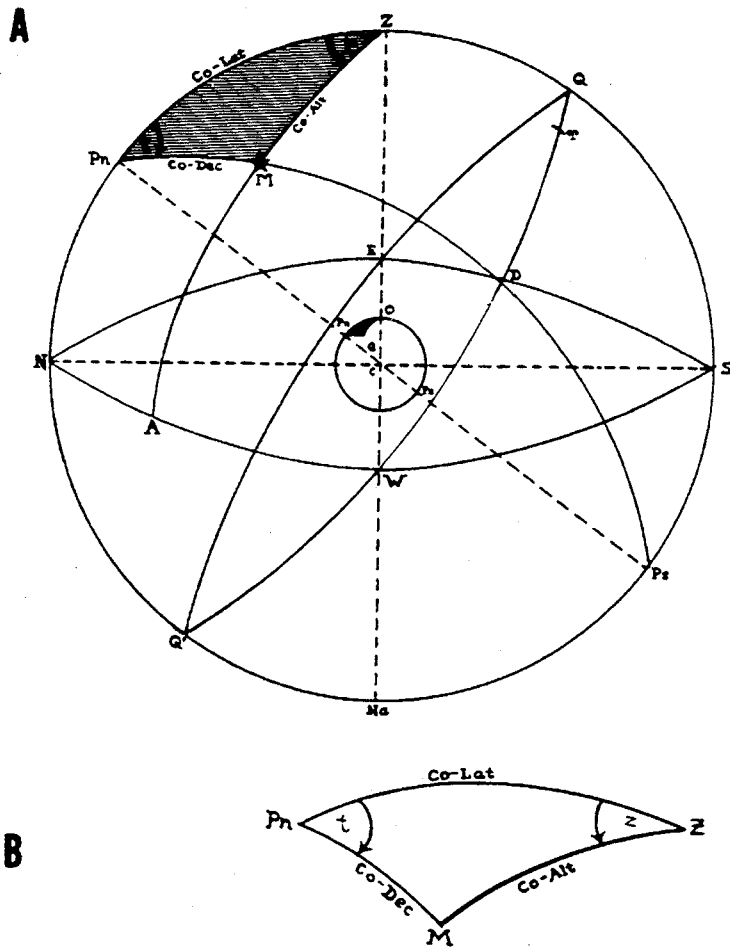

- The parts of the adjacent figure are:
- c Common center of terrestrial & celestial spheres.
  - N,E,S,W, Observer's north, east, south & west points respectively on the horizon.
  - NESWAN Observer's horizon.
  - Pn & Ps North & South celestial poles (also poles of the earth).
  - Z & Na Zenith & Nadir.
  - Q & Q' Points of intersection of equinoctial with upper and lower branches of the observer's meridian.
  - NPnZQSPsNaQ' Celestial meridian of the observer.
  - EQrDWQ Equinoctial.
  - r Vernal equinox or first point of Aries.
  - ZQ Latitude of the observer.
  - O Terrestrial point of the observer.
  - PnMDPs Hour circle of celestial body M.
  - M Celestial body.
  - ZMA Vertical circle of body M.
  - G Ground point.
  - DM Declination of star M.
  - tD SHA of star M.
  - tQE'Q'WD RA of star M.
  - QD LHA of star M.
  - NA Azimuth angle of star M.
  - NESWA Azimuth of star M.
  - AM Altitude of star M.
  - t Meridian angle.
  - Z Azimuth angle measured at zenith.
  - PnM Co-dec or polar distance.
  - MZ Co-alt or zenith distance.
  - PnZ Co-lat or polar distance of the zenith.
  - PnZM Astronomical triangle.
  - PnOG Navigational triangle.

Figure 1-3A. The celestial sphere. B. Astronomical triangle.

TERRESTRIAL SYSTEM	CELESTIAL SYSTEM	HORIZON SYSTEM
A Poles	Celestial poles	Zenith; nadir
B Equator	Celestial equator	Horizon
C Parallels of Latitude	Diurnal circles	Altitude circles
D Latitude	Declination	Altitude
E Co-latitude	Polar distance	Zenith distance
F Meridians	Hour circles	Vertical circles
G Longitude	RA,SHA,GHA,LHA,t	Azimuth or Az.angles
H Greenwich meridian	Hour circle	Celestial meridian

Figure 1-4 - Elements of the three systems of navigation.

make unnecessary the computation of complements.

## MAGNITUDE

The brightness of a celestial body is expressed in terms of magnitude. The stars are divided into six groups according to brightness. The first group is considered to be 100 times brighter than the sixth group. Therefore, the magnitude ratio is the fifth root of 100 or 2.512 and a zero magnitude body is 2.512 times brighter than a first magnitude body, which is 2.512 times brighter than a second magnitude body, etc.

Using this scale, the two brightest stars, Sirius and Canopus, have negative magnitudes of -1.6 and -0.9 respectively. First magnitude stars are 1.50 or brighter. Those between 1.51 and 2.50 are second magnitude; between 2.51 and 3.50 are third magnitude; between 3.51 and 4.50 are fourth magnitude; between 4.51 and 5.50 are fifth magnitude; and those between 5.51 and 6.50 are sixth magnitude. Sixth magnitude stars are barely visible to the unaided eye. The sun's magnitude is about -26.7 and a full moon's magnitude is about -12.6. The planets Venus, Mars, and Mercury also have negative magnitudes at certain times of the year.

## SPECIAL CELESTIAL RELATIONSHIPS

The following relationships are worthy of note in any study of the celestial sphere:

a. A body on the observer's celestial meridian has an azimuth of either 000 or 180, and is either at its greatest or least altitude depending upon whether it is transiting the upper or lower branch of the meridian.

b. A body on the prime vertical has an azimuth of either 090 or 270.

c. When a body is on the horizon, it is either rising or setting.

d. When the declination and latitude are of the same name, the body will be above the horizon more than half the time, and it will rise and set between the prime vertical and the elevated pole.

e. If declination and latitude are of the same name and equal, the body will pass through the zenith. When in the zenith, it has no azimuth or azimuth angle.

f. When the declination is of the same name as the latitude and numerically greater than the co-lat, the body is circumpolar. (It never sets.)

g. When declination is 0 degrees, a body rises in the east and sets in the west.

h. When the declination is of contrary name (as compared to latitude), and greater than the co-lat, the body never rises.

i. At the equator, the celestial poles coincide with the celestial horizon. There are no circumpolar stars nor stars that never rise. Stars rise and set in planes which are perpendicular to the plane of the horizon.

j. At the poles, the equinoctial coincides with the celestial horizon, the only bodies visible are those with a declination of the same name as latitude, and all these are circumpolar. Altitude then equals declination, and azimuth is insignificant since all directions at the north pole are south and at the south pole all directions are north.

### SELF-QUIZ #1

1. The first group of stars to become visible to the the naked eye at twilight are called \_\_\_\_\_ magnitude stars.

- A. second
- B. third
- C. first
- D. fifth

2. Second magnitude stars range in magnitude from \_\_\_\_\_.

- A. -1.6 to 1.5
- B. 1.5 to 2.5
- C. 2.5 to 3.5
- D. 3.5 to 4.5

3. The northern pole of the earth is aligned almost exactly with the star \_\_\_\_\_.

- A. Vega
- B. Deneb
- C. Canopus
- D. Polaris

4. The celestial equivalent of terrestrial latitude is called \_\_\_\_\_.

- A. declination
- B. meridian
- C. zenith
- D. culmination

5. The First Point of Aries is another name for the \_\_\_\_\_ equinox.

- A. December
- B. September
- C. June
- D. March

6. A body on the prime vertical has an azimuth of either \_\_\_\_\_.

- A. 000 or 180
- B. 090 or 270
- C. 135 or 315
- D. 225 or 045

## ANSWERS TO SELF-QUIZ #1

QUESTION	ANSWER	REFERENCE
1	C	1-10
2	B	1-10
3	D	1-3
4	A	1-5
5	D	1-6
6	B	1-10

## TIME

Reading Assignment: 2  
Pages 2-1 through 2-15

### OBJECTIVES

To successfully complete this assignment, you must study the text and master the following objectives:

1. List and define the different methods by which you reckon time.
2. Define the equation of time. State where you can find the daily equation of time.
3. State the three references used to determine mean solar time. Name the types of time determined using each reference.
4. Describe the use of the time diagram. Solve problems using the time diagram.
5. List the instruments used to determine time.

### INTRODUCTION

With nautical astronomy background as a prerequisite, the practice of celestial navigation may now be approached, commencing with the study of time and timepieces.

During the Newtonian era, great advances in mathematics and in the physical sciences made available (a) a great deal of information concerning the positions of stars and planets; (b) greater knowledge of gravitation; and (c) more information in general concerning the celestial bodies beyond our solar system. The Post-Newtonian era was characterized by the practical application of the new knowledge of astronomy.

An early problem was that of determining longitude at sea. As we shall see later latitude can be readily determined by a meridian sight without knowledge of exact time or resort to spherical trigonometry. However, longitude cannot be so easily obtained. Accordingly, in 1714, British sea captains petitioned the House of Commons for a solution to the problem of determining longitude. By 1735, John Harrison had produced a marine chronometer which advanced considerably the practice of navigation,

making it possible to more accurately compute longitude.

### IMPORTANCE OF TIME

The navigator steps out on the bridge wing and takes a sight on the star Vega. After applying various corrections to the sextant altitude, the navigator finds the altitude of Vega from position at the instant of observation. Information in tables provide the altitude of Vega from a previously selected assumed position (AP) at the same exact instant. The assumed position is chosen somewhat arbitrarily. It may be the dead reckoning position, and estimated position, or any arbitrarily chosen position nearby. The navigator then finds (again, from tables) the azimuth of Vega from the AP. The difference between the altitude from the actual position enables the navigator to calculate the distance from the AP at the instant of observation. The navigator measures this distance along the azimuth line, and thus establishes a line of position.

The foregoing is only a general outline of how a line of position is determined by celestial navigation. The reason it is inserted here prematurely is to impress upon you the

importance of the time element in navigation. Suppose the navigator's observation is inaccurate by 1 minute. Although 1 minute isn't very long, it can make a considerable difference in navigation. Instead of the observed altitude, suppose the altitude for a minute earlier or later is worked out. This could produce an error of as much as 15 miles in the resulting line of position. Regardless of your latitude, a 1 minute time error produces a 15-minute error in longitude. On a mercator chart, on the equator, 1 minute of longitude equals 1 nautical mile.

You know, of course, that the motion of the sun and the stars around the earth is only apparent - an illusion created by the rotation of the earth itself. In the discussion of time, which follows, simply consider the heavenly bodies as moving around the earth.

## TIME MEASUREMENT

With this brief historical introduction, time may now be defined as the sum of all the days in the past, today, and all the days of the future. However, we think of time, as a quantity which can be measured. Time may be expressed as a measured duration, such as three hours, and also as "clock time," for example, 0200. The instrument for making this measurement is a timepiece. The earth is our celestial timepiece. Each turn upon its axis provides a unit of time known as the day. Time is important to the navigator because of its relationship to longitude.

Two general types of time measurement are solar time and sidereal time. Solar time is based upon the rotation of the earth with respect to the sun while sidereal time is based upon the rotation of the earth with respect to the stars.

## SOLAR TIME

We will at first restrict our discussion to solar time, commencing with a type called apparent time which is time measured upon the basis of the apparent motion of the real sun. By apparent time when the sun transits the upper branch of the local celestial meridian, the time is spoken of as local apparent noon (LAN) or 1200 apparent time. When the sun transits the lower branch of the local celestial meridian, the time may be

spoken of as local apparent midnight or 2400 (also 0000). Unfortunately, the length of the apparent day varies. This results because of two reasons:

a. The ellipticity of the earth's orbit. The earth when relatively near the sun rotates once with respect to the sun in less time than when relatively far from the sun. This occurs because the earth is moving in its orbit while rotating.

b. The sun's apparent movement with respect to the earth is faster at the solstices, when the sun is moving almost parallel to the equinoctial, than at the equinoxes when the direction of the sun's apparent motion has a larger north-south component.

Since apparent days are unequal in length, it is impractical for man-made timepieces to keep apparent time. As an expedient, we have averaged the length of the 365 1/4 apparent days (1 solar year), and arrived at a measurement known as mean time. One mean day is 24 hours in length, each hour consisting of 60 minutes and each minute consisting of 60 seconds. We can say that mean time is based upon the motion of an imaginary sun moving westward in the equinoctial at a uniform speed. At the instant the imaginary sun transits the upper branch of the local celestial meridian, we witness local mean noon (1200 local mean time). At the instant the imaginary sun transits the lower branch of the local celestial meridian, we observe local mean midnight (2400 or 0000 local mean time).

Four times a year the positions of the mean and true sun coincide. On those four occasions (and only those) there is no difference between apparent and mean time. Otherwise, there always is a difference, called the equation of time, which is listed in the Nautical Almanac for every 6 hours of Greenwich mean time (GMT) of the sun on any date. The equation of times reaches a maximum of nearly 16½ minutes.

## EQUATION OF TIME

At different times during the year, the apparent sun moves across the heavens at a slower or faster rate than the mean sun. The

apparent sun may be as much as 16½ minutes ahead or behind the mean sun. As can be seen in figure 2-1, there are three entries in the sun block of the Almanac for each day.

Day	SUN		
	Eqn. of Time		Mer. Pass.
	00 <sup>s</sup>	12 <sup>s</sup>	
1	03 09	03 24	12 03
2	03 38	03 52	12 04
3	04 06	04 20	12 04

Figure 2-1 Equation of time for January 1,2, and 3 of 1983 Almanac

The first column (00h) gives the number of minutes and seconds that the apparent sun is either behind or ahead of the mean sun as these bodies transit the lower branch of the Greenwich meridian (180th meridian). The second column (12h) contains the time differences at the upper branch, or prime meridian. The third column (Mer. Pass.) contains the local times at which the apparent sun will pass over or transit the Greenwich meridian. During the period 1-3 January, the local mean time at which the apparent sun will transit the Greenwich meridian is approximately 1204. Therefore the apparent sun on these dates, by the amount of minutes and seconds shown in the first two columns for each day in figure 2-1. On the other hand, where the apparent sun is ahead of the mean sun, the times of meridian passage shown in the third column would be 1159 or earlier, with the first two columns indicating the exact amount. Because the equation of time will vary by a few seconds in the course of each day, the local mean time of the sun's meridian passage at Greenwich can also be used for all other meridians. For example, on 1 January the apparent sun will transit the upper branches of all meridians approximately 3 minutes behind the mean sun. Thus, the apparent sun will cross the standard meridians of all time zones at 1204 local mean time (equal to 1204 local zone time).

The equation of time is used primarily for determining the local mean times of meridian passage of the apparent sun at Greenwich, so that we can determine the zone time of apparent noon or commonly referred to as local apparent noon or LAN.

## SIDEREAL TIME

Sidereal time, or star time, is based upon the earth's rotation with respect to the stars. Sidereal and solar time differ in the four following ways:

a. Reference. The sun is the reference point for solar time. The first point of Aries is the reference point for sidereal time.

b. Commencement of Day. A solar day commences when the sun transits the lower branch of the local celestial meridian (midnight). A sidereal day commences when the first point of Aries transits the upper branch of the local celestial meridian (sidereal noon).

c. Date. There is no sidereal date.

d. Length of Day. A sidereal day is 3 minutes and 56 seconds shorter than a solar day (figure 2-2), which provides for 366 1/4 sidereal days in a solar year (365 1/4 solar days). The reason for a sidereal day being shorter is the fact that while the earth rotates with respect to the sun it also travels in its orbit. When the earth has rotated once with respect to the stars, its travel in its orbit has necessitated that it turn almost an additional degree in order to have rotated once with respect to the sun.

## ZONE (STANDARD) TIME

We have seen that local mean time on the fore-castle can be different from local mean time on the main deck aft. In other words, local mean time always differs in different longitudes. In a large city, for example, a difference of about 9s LMT occurs between one end of the city and the other end.

You can understand, now, how a general foulup would result if everyone set their watch on their own LMT. The watch would have to be changed every time a person went a few blocks on a street running east and west. To eliminate this difficulty, standard time zones have been established, within which all clocks are set to the same time. A difference of 1 hour takes place between one time zone and the next. Because 1h is 15°,



## ZONE TIME AND GMT

If GMT is the time at the Greenwich meridian, measured by the mean sun, and the Greenwich meridian is the standard time meridian for the 0 time zone, therefore, zone time anywhere in the 0 zone is the same as GMT. Most of the information in navigational tables relates to GMT.

The solar day contains 24h, and each time zone represents 1h, so there must be 24 zones. Beginning with the 0 (Greenwich) zone, time zones run east and west from zone 1 to zone 12. (See figure 2-3.) Zones east of Greenwich are minus; those west of Greenwich are plus zones. (Note that +12 and -12 time zones each include only  $7\frac{1}{2}^{\circ}$  of longitude. In other words, in zones east of Greenwich, you must subtract the zone number from the zone time to find Greenwich time. In zones west of Greenwich, you must add the two. The zone time at Greenwich is GMT; consequently, the zone number tells you the difference in hours between your zone time and GMT.

Standard time zones are also designated by letters. You can get the equivalent letter designation from the numbered zone by referring to figure 2-3. All letters are used except for the J because the -12/+12 time zone uses two letters.

The 180th meridian is the central meridian of time zone 12 which is common to both hemispheres. However the half in the eastern hemisphere has a ZD of -12, and the half in the western hemisphere has a ZD of +12. For this reason, and since the Greenwich time zone is known as 0, we have 24 time zones but 25 zone descriptions.

Because there is a standard time meridian for every  $15^{\circ}$  of longitude, you divide your longitude by  $15^{\circ}$  to find which zone you are in. Then, to find GMT, you merely apply the zone description (ZD) according to its sign.

To illustrate, assume that you are in longitude  $105^{\circ}$  E., ZT is 16h 23m 14s, and you want to find GMT. Divide 105 by 15 and you get 7, which means you are in time zone 7. You are in east longitude, so the sign is minus. Therefore, your ZD is -7. The minus

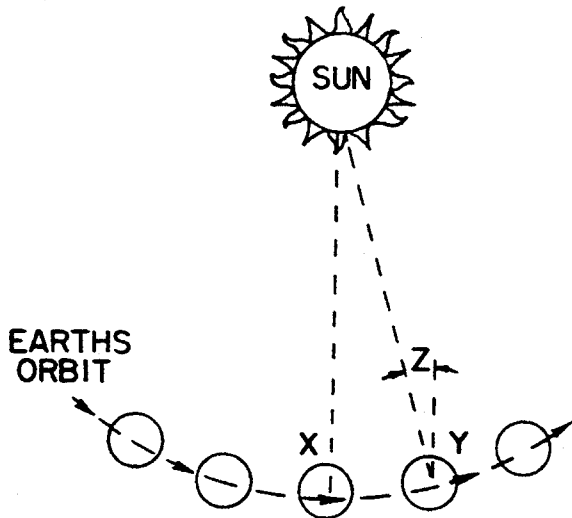

Figure 2-2 Difference between sidereal and mean solar days. In this figure, the earth begins rotation at position X. At position Y, the rotation is completed with respect to the stars, but not the sun, the earth must still rotate a small amount. Position Z, is the angle needed to complete the rotation with respect to the sun.

You can see that each time zone comprises  $15^{\circ}$  of longitude.

The standard time zones begin at the Greenwich meridian ( $0^{\circ}$ ). Every meridian east and west of Greenwich that is a multiple of  $15^{\circ}$  ( $15^{\circ}$ ,  $30^{\circ}$ ,  $45^{\circ}$ ,  $60^{\circ}$ ,  $75^{\circ}$  and so on) is a standard time meridian. Each standard time meridian is at the center of its time zone, and the zone extends  $7^{\circ}-30'$  (half of  $15^{\circ}$ ) on either side of the meridian. Ashore, however, certain standard time zones differ for population, economic or governmental reasons, and for various other reasons of convenience.

Local mean time along each standard time meridian is zone (standard) time for the entire time zone. Zone time in navigation is abbreviated ZT.

DAYLIGHT SAVING TIME IS SIMPLE ZONE TIME SET AHEAD 1 HOUR (SOMETIMES 2 HOURS) TO EXTEND THE TIME OF DAYLIGHT. DAYLIGHT SAVING TIME MUST BE ACCOUNTED FOR WHEN USING TIMES FROM THE PUBLICATIONS IF YOUR SHIP IS KEEPING DST.

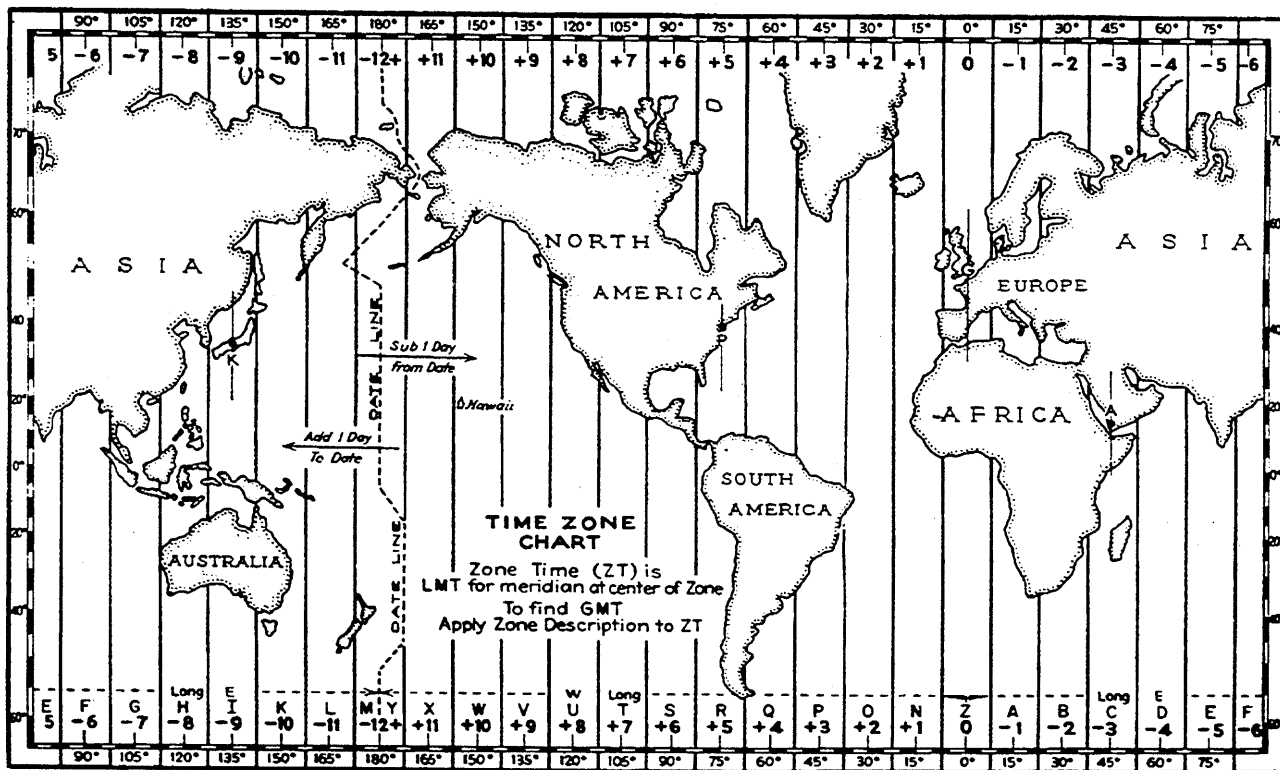

Figure 2-3 Standard time zones.

sign means that you subtract ZD from ZT to find GMT.

Thus:

$$\begin{array}{r}
 \text{ZT} \quad 16\text{h} \quad 23\text{m} \quad 14\text{s} \\
 \text{ZD} \quad -7 \\
 \hline
 \text{GMT} \quad 9\text{h} \quad 23\text{m} \quad 14\text{s}
 \end{array}$$

Or, say you're in longitude 75° W., ZT is 7h 13m 57s, and you want to find GMT. Divide 75 by 15 and your answer is 5. Therefore, you are in zone 5, and it must be plus 5, because your longitude is west. Consequently:

$$\begin{array}{r}
 \text{ZT} \quad 7\text{h} \quad 13\text{m} \quad 57\text{s} \\
 \text{ZD} \quad +5 \\
 \hline
 \text{GMT} \quad 12\text{h} \quad 13\text{m} \quad 57\text{s}
 \end{array}$$

Your longitude coincided with a standard time meridian in both examples, which simplified things somewhat. If they are not located on one of these meridians, you can figure out which zone you're in by dividing your longitude by 15, and observing the size of the remainder. You must bear in mind that each standard time meridian is at

the center of its time zone, and the zone extends 7° 30' on either side of the meridian. For example, say your longitude is 142° 41' W., and you want to know ZD. Dividing 142° 41' by 15, you have 9, with 7° 41' left over. But 7° 41' is more than 7° 30', so you must be in the zone next beyond zone 9, meaning zone 10.

### TIME AND DATE

When the mean sun is over the Greenwich meridian, the time is noon, GMT. Because it is noon, GMT, it must be 12 hours later (midnight) at the 180th meridian on the other side of the earth. In other words, the sun is just starting its 24-hour cruise, it is the same day all the way around the earth, but a new day is about to begin at the 180th meridian.

The date changes at the 180th meridian. Going west, it becomes the next day at 180°; going east, it becomes the day before.

When you refer to GMT in the Nautical Almanac, you must know what the date is at

Greenwich. Frequently, the date there differs from the date in you longitude. For example, say that on 1 May you are in longitude  $176^{\circ} 41'$  W., and ZT is 16h 0m 0s. Divide  $176^{\circ}$  by 15. The nearest whole number is 12, the ZD. Longitude is west, therefore ZD is +12. Adding ZD to ZT, we obtain the following:

ZT	16h	0m	0s	1 May)
ZD	12			
GMT	28h	0m	0s	

What have we here, 28 o'clock? Time 2800 on 1 May is the same as 0400 on 2 May. Therefore, GMT is 4h 0m 0s on 2 May.

Suppose that at the same ZT you were in longitude  $176^{\circ} 41'$  E., on the other side of  $180^{\circ}$ , where it is 2 May. In this example, ZT is -12 but GMT comes out the same; the date where you are is the same as the date at Greenwich. In the former problem, it already has become a day later at Greenwich.

ZT	16h	0m	0s	(2 May)
ZD	-12			
GMT	4h	0m	0s	(2 May)

Here is a problem with a new twist. Suppose you're in longitude  $47^{\circ} 53'$  E., ZT is 2h 0m 0s, and the date is 2 May. The ZD is -3. (You should know why by now.) How can you subtract 3 from 2h 0m 0s? Time 0200 on 2 May is the same as 2600 on 1 May. The figuring goes like this:

ZT	26h	(1 May)
ZD	-3	
GMT	23h	(1 May)

## ZONE AND LOCAL MEAN TIME

Zone time is a matter of convenience only. It was established to keep all clocks in a specific area on the same time. The actual real time where you are is the local mean time, which changes continually as the sun moves, and also changes as you change your longitude.

If you are located on one of the standard time meridians, then zone time and local mean time are the same. Otherwise, you must calculate local mean time according to the difference in longitude between your meridian and the next higher

standard time meridian. You do this by subtracting your longitude from the longitude of the time meridian. This gives you a result in degrees, minutes, and seconds of arc, which you convert to time and apply to the zone time.

Suppose your DR longitude is  $142^{\circ} 41'$  W., and ZT is 06h 21m 09s. Divide  $142^{\circ} 41'$  by 15, and you find that you are in zone +10. This means that your standard time meridian must be  $150^{\circ}$  W. Write that down as  $149^{\circ} 60'$  W., so that subtracting your longitude will be easier.

Longitude time meridian	$149^{\circ} 60'$ W.
Longitude your meridian	$142^{\circ} 41'$
Longitude difference	$7^{\circ} 19'$

Change  $7^{\circ} 19'$  to time, and you get 0h 29m 16s. This means that LMT at your meridian differs from ZT by 0h 29m 16s. Is your time later or earlier than the time at  $150^{\circ}$  W.? That depends upon whether you are east or west of that meridian. You are in west longitude, which is measured west from  $0^{\circ}$  to  $180^{\circ}$ , so  $150^{\circ}$  W. must be farther west than  $142^{\circ} 41'$  W. Therefore, you must be east of the standard time meridian. It is always later to the east; consequently, your LMT must be 0h 29m 16s later than ZT. This is represented as follows:

ZT	06h	21m	09s
	00h	29m	16s
LMT	06h	50m	25s

## TIME CONVERSION TABLE

The time conversion table (figure 2-4) is useful for converting time in one zone to time in any other zone. Vertical columns indicate time zones. Zone Z is GMT. Time in each successive zone to the right of zone Z is 1 hour later, and to the left of zone Z is 1 hour earlier. Time in each successive shaded area to the right is 1 day (24 hours) later; to the left it is 1 day (24 hours) earlier.

To calculate time in zone U when it is 0500 hours in zone I, for example, proceed as follows: find 0500 in column I and locate the time (1200) in the corresponding line in column U. Inasmuch as 1200 is not in the shaded area, the time is 1200 hours yesterday.



## CONVERSION OF ARC TO TIME

0°-59°			60°-119°			120°-179°			180°-239°			240°-299°			300°-359°			0'00	0'25	0'50	0'75					
°	'	"	°	'	"	°	'	"	°	'	"	°	'	"	°	'	"	m	s	m	s					
0	0	00	60	4	00	120	8	00	180	12	00	240	16	00	300	20	00	0	0	00	0	01	0	02	0	03
1	0	04	61	4	04	121	8	04	181	12	04	241	16	04	301	20	04	1	0	04	0	05	0	06	0	07
2	0	08	62	4	08	122	8	08	182	12	08	242	16	08	302	20	08	2	0	08	0	09	0	10	0	11
3	0	12	63	4	12	123	8	12	183	12	12	243	16	12	303	20	12	3	0	12	0	13	0	14	0	15
4	0	16	64	4	16	124	8	16	184	12	16	244	16	16	304	20	16	4	0	16	0	17	0	18	0	19
5	0	20	65	4	20	125	8	20	185	12	20	245	16	20	305	20	20	5	0	20	0	21	0	22	0	23
6	0	24	66	4	24	126	8	24	186	12	24	246	16	24	306	20	24	6	0	24	0	25	0	26	0	27
7	0	28	67	4	28	127	8	28	187	12	28	247	16	28	307	20	28	7	0	28	0	29	0	30	0	31
8	0	32	68	4	32	128	8	32	188	12	32	248	16	32	308	20	32	8	0	32	0	33	0	34	0	35
9	0	36	69	4	36	129	8	36	189	12	36	249	16	36	309	20	36	9	0	36	0	37	0	38	0	39
10	0	40	70	4	40	130	8	40	190	12	40	250	16	40	310	20	40	10	0	40	0	41	0	42	0	43
11	0	44	71	4	44	131	8	44	191	12	44	251	16	44	311	20	44	11	0	44	0	45	0	46	0	47
12	0	48	72	4	48	132	8	48	192	12	48	252	16	48	312	20	48	12	0	48	0	49	0	50	0	51
13	0	52	73	4	52	133	8	52	193	12	52	253	16	52	313	20	52	13	0	52	0	53	0	54	0	55
14	0	56	74	4	56	134	8	56	194	12	56	254	16	56	314	20	56	14	0	56	0	57	0	58	0	59

Figure 2-5 Extract from the Nautical Almanac.

the Nautical Almanac. (See figure 2-5.) But if you acquire the following easy methods of converting, you won't have to refer to pubs. First, you must memorize the values for arc and time in the accompanying table.

Equivalents  
 Time to Arc  
 24h = 360°  
 1h = 15°  
 1m = 15'  
 1s = 15"

-Arc and Time  
 Arc to Time  
 360° = 24h  
 1° = 4m  
 1' = 4s

The only reason you need to memorize the preceding values is to make it easier to remember the methods for converting arc and time.

### TIMEPIECES

#### CLOCKS AND WATCHES

The ship's routine activities are timed by the various ship's clocks or deck clocks, mounted on the bulkheads and usually set to ZT. When the ship enters a new time zone, a quartermaster makes the rounds of all clocks, resetting them 1 hour one way or the other, depending upon whether the ship is moving east or west. The commanding officer specifies when the clocks will be changed and what time they will be changed to.

The ship's clocks are reasonably accurate timepieces, suitable for timing chow, watch changes, and so on. Time in navigation is one of the most exacting elements of that science, and navigational timepieces must be as accurate as human ingenuity can make them.

#### CHRONOMETER

Chief among navigational timepieces is the chronometer (figure 2-6), one of the most accurate mechanical time machines devised. If a ship does not have a chronometer and must navigate at any time by celestial observations, it is provided with a timepiece that reasonably approximates the chronometer's accuracy.

The chronometer is a clock of unusually fine construction. It is designed for extreme accuracy and dependability, and is built to withstand shock, vibration, and variations of temperature. Like the magnetic compass, it is mounted in gimbals to offset the motion of the ship. It must be handled with the greatest care, because its accuracy and regularity are essential in determining GMT, the basic time used in fixing position by celestial navigation.

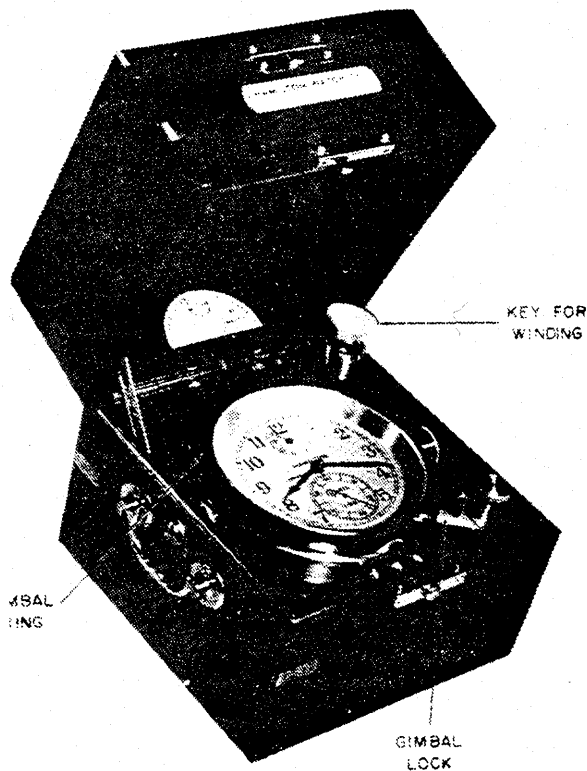

Figure 2-6 Ship's chronometer in its case.

### Care of Chronometer

Before the instrument is moved, the chronometer gimbal ring must be locked. It must remain locked during transportation. For transportation over considerable distances (as by express), follow BuShips instructions. For transportation from ship to pool, or vice versa, the instrument should be hand-carried in its gimbal box by a responsible member of the bridge gang. It must be particularly guarded against shocks and jars, and especially against any quick rotary motion.

Before the chronometer is received on board, complete preparations should be made for its immediate installation. The stowage locker (figure 2-7) should be located as near as possible to the ship's centerline, where the effect of rolling is minimized. Chronometers should never be installed near masses of vertical iron or charged electrical machinery. They should be placed where they are least subject to drafts, temperature changes, the jar or vibration of machinery, and the shock of gunfire.

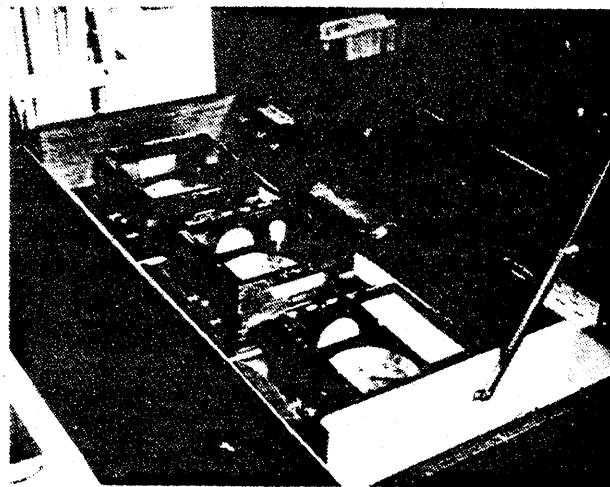

Figure 2-7 Stowage of ship's chronometers.

### Winding Chronometers

Chronometers are started and set to GMT at the chronometer pool. They must be wound regularly at the same time each day to ensure uniform performance, although they usually are designed to run for 56 hours without rewinding. If a chronometer should run down, the consequences would be serious, hence a better means than memory alone must be used as a reminder of the daily winding duty. The number of hours elapsed since the last winding is indicated on the face of each chronometer.

To wind the chronometer properly, invert the main assembly on its gimbles to expose the rear of the main clock assembly. Rotate the dust cover to expose the key hole and insert the winding key. It is usually sufficient to wind the chronometer seven half turns counterclockwise. Make the last turn slowly so the spring will not be brought hard against the mechanical stop. Remove the key, and the cover will return automatically. Return the instrument to its normal position and check the winding indicator to ensure the instrument is fully wound.

When a ship has more than one chronometer, they should be wound in the same sequence to prevent omissions. The Quartermaster of the Watch customarily winds the chronometers at 1130 each day. A report of this action is made to the commanding officer by the OOD at 1200.

## Error and Rate

Even a chronometer cannot keep exact time indefinitely, so sooner or later the chronometer time gradually begins to draw away from GMT. It was set to GMT, as nearly as possible, before delivery on board the ship. The chronometer error (difference between chronometer time and GMT) increases progressively, depending on the particular chronometer's rate.

Chronometer rate is the amount the instrument gains or loses in a day. For example, a chronometer whose rate is 1.5 seconds, gaining, will gain 1.5 seconds every 24 hours. Chronometer rate may change with variations of temperature, and the like, but the instrument still is considered reliable as long as the rate does not change unreasonably. To use it, both the rate and the error must be known.

A copy of NavShips 4270 accompanies each chronometer, navigating watch, or other navigational timepieces. (Incidentally, watches not mounted in gimbals are not officially navigational timepieces.) Besides instructions on care and handling, NavShips contains a 4270 graph labeled "Rate Curve Obtained During Trial," which shows the rates observed in a final test made at various temperatures at the chronometer supply pool.

Chronometer rate should be checked frequently by comparison with the true time. This should be done at least every 10 days. Suppose the last known rate was 2.5, gaining, and the chronometer was 4m 20s ahead of GMT on 1 February. If the rate remains the same, in 10 days the instrument should gain 2.5 times 10, or 25.0 seconds. Suppose that on 11 February, you find the chronometer is 4m 50s fast instead of 4m 45s fast. Obviously, it gained 5 seconds more than it should have at the last known rate. This is an average or mean of 05s per day, making the new rate 3.0s instead of 2.5s, gaining.

## Determining Chronometer Error

Since chronometers are never reset aboard ship, an accumulated error may become quite large. This is unimportant, though, if an accurate record is kept of the error.

The best and most accurate check on the chronometer and other timepieces is the radio time signal, broadcast by stations listed in Radio Navigational Aids (P.U.B. 117). Naval radio stations transmit time signals for the 5 minutes immediately preceding certain hours GMT. You must familiarize yourself with their pattern, as follows:

Each second in the time signal is marked by the beginning of a dash; the end of the dash has no significance. Beginning at 5 minutes before the hour, every second is transmitted except the 51st second of the 1st minute, 52nd second of the 2nd minute, 53rd second of the 3rd minute, 54th second of the 4th minute, 29th second of each minute, the last 4 seconds of each of the first 4 minutes, and the last 9 seconds of the last minute. The hour signal after the 9-second break consists of a longer contact than the others.

Radio time signals are broadcast worldwide by several U.S. Navy and Bureau of Standards radio stations, among which are stations NSS (Annapolis, Maryland), WWV (Ft. Collins, Colorado), and WWVH (Maui, Hawaii). Although the signals are used on USCG ships primarily for checking the accuracy of chronometers and other shipboard timepieces, they can be used as a means of setting the comparing watch or stopwatch prior to recording celestial observations. The time signals transmitted by station WWV (Bureau of Standards) are based on time reckoned by the resonance of the cesium atom. This time, called Coordinated Universal Time (CUT), is used as a basis for all radio time signals. CUT differs from GMT by about 2 milliseconds per day. Most stations transmit time signals for the five minutes immediately preceding certain hours of GMT; WWV and WWVH give the correct time by voice announcement every 5 minutes 24 hours a day. The upcoming time is announced during the interruption of the audio-frequency. The exact time is taken at the instant when the audio frequency is resumed.

The most accurate timepiece on board, usually a chronometer, is checked against the time signal, and its error is recorded in NavShips 4270 for that instrument. Errors of the others can be calculated by referring to the recorded data.

Secondary methods of checking the accuracy of timepieces are (1) determining exact noon by means of the sextant and Nautical Almanac, and (2) comparing three timepieces. The first of these requires a knowledge of your exact position; but even with this knowledge, it is less accurate than the time signal.

Comparison of timepieces determines which one is erratic. If only two are compared, even though a radical difference in rate should appear, you would not be able to tell which instrument is in error. By comparing the daily readings of three navigational timepieces, you are able to detect whatever irregularity occurs in any one of them.

Chronometer error (CE) is simply the amount the chronometer is ahead of or behind GMT. To find GMT, you either add CE to Chronometer time (CT), or subtract it from CT, depending upon whether the chronometer is slow or fast.

**Chronometer - Watch (C Minus W) Computation**

The importance of obtaining the exact GMT of every celestial observation was mentioned already. Obviously it would be impractical if, every time you took a sight on the bridge wing, you had to dash into the charthouse and look at the chronometer. Consequently, every observation is timed the instant it is made, either by a stopwatch or by a comparing watch.

The stopwatch can be started exactly on some convenient minute or hour of the chronometer. If its rate is known to be small, there is no necessity for working out any chronometer-minus-watch (C-W) and computation, provided the interval during which observations are taken is short. Single-function watches, once they are started, can only be stopped once. Multi-function watches can be stopped and started as often as necessary without affecting the time it was originally started. (See figure 2-8.)

A comparing watch can be set to chronometer time and can be used to keep time, if its rate also is small. Some navigators, though, prefer to keep their

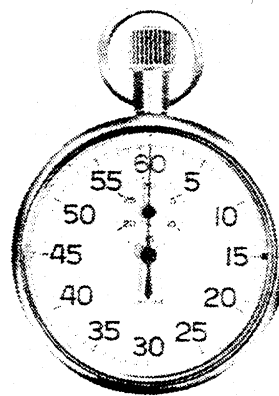

Figure 2-8 Standard stopwatch.

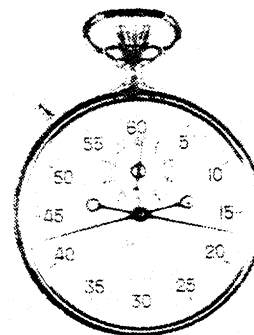

Figure 2-9 Comparing watch.

watches on zone time, so that observations then must be timed by computation. It doesn't matter whether computation is made before or after the observation, but it is essential to have the interval as short as possible between time of sight and time of computation. Otherwise, enough time may elapse for the watch to gain or lose a sufficient amount to cause an error. For better accuracy and to avoid careless errors, you should make C-W computations both before and after a round of sights. (See figure 2-9.)

The C-W computation is watch time (WT) to the half-second subtracted from chronometer time (CT). If WT is greater, 12 hours are added to CT. The C-W is never greater than 12 hours, because both watch and chronometer are graduated only to 12. Now that you know C-W, you need only to add it to the WT of any observation to find



its CT, then apply CE, and you have the GMT of the observation.

Let's take an example. Assume that you have a chronometer whose error (CE) is -7m 4s; in other words, it is 7m 4s behind GMT. Your watch is set to ZT and reads 5h 26m 42s when the chronometer reads 10h 19m 00s. First, find the C-W. It's WT subtracted from CT.

CT	10h	19m	00s
WT	5h	26m	42s
C-W	4h	52m	18s

You step out on the bridge with your sextant and watch, and sight on Sirius at WT 5h 34m 21s, dated 15 October, longitude 101° 34.2' E. What is the GMT of this sight? Applying the formula  $CT = WT + C - W$ , we find:

WT	5h	34m	21s
C-W	4h	52m	18s
CT	10h	26m	39s

The CT is the chronometer time of the observation. Apply CE to CT to find GMT. The CE minus, meaning that the chronometer is behind GMT; therefore, CE must be added to CT. Thus:

CT	10h	26m	39s
CE		7m	04s
GMT	10h	33m	43s

Now let's consider the date 15 October at 101° 34.2' E. Is it the same day at Greenwich? Let's see. The zone time is 5h 34m 21s. The ZD is -7. Subtract ZD from ZT to get GMT. You can't subtract 7 from 5, but 5h on 15 October is the same as 29h on 14 October, and 7 from 29 is 22. Therefore, 10h 33m 43s is not a.m. on 15 October, but p.m. on 14 October. From this computation, therefore, GMT is 22h 33m 43s on 14 October.

In problems like these you must check the date carefully every time to avoid a 12-hour error such as the one just encountered.

The quartz crystal oscillator clock is being used as a replacement for the spring-driven chronometers aboard some ships. It is highly resistant to shock and vibration, and

does not need to be gimballed. Among its other virtues is that it can be set while running. Most models have a sweep second hand, which can be advanced or retarded electronically in increments of one-tenth or one one-hundredth of a second while the clock is running. Kept at a reasonably steady temperature, these clocks are capable of maintaining an excellent rate. The better models, under stable temperature conditions, can be expected to deviate less than 0.01 seconds from their average daily rate. A single set of batteries generally last about a year.

## TIME DIAGRAM

In the time diagram, the observer is theoretically located outside the celestial sphere, over its south pole. The diagram consists merely of a circle representing the celestial equator. The center of the circle is the south celestial pole. Counterclockwise direction is westerly. The local meridian is drawn in as a vertical line, thus placing the upper branch (M) at the top of the diagram and the lower branch (m) at the bottom. To avoid confusion, the lower meridian is shown by a dashed line.

You locate the Greenwich meridian by means of your longitude (symbol  $\lambda$ ). If you were in 90° W. longitude, G would appear on your diagram 90° clockwise from M (because you're counterclockwise or west of G). A glance at figure 2-10 will confirm this location. What you really do, then, is count from M toward Greenwich, the direction depending upon whether you are in east or west longitude.

Figure 2-11 shows another time diagram on which GHA of the sun is indicated. The upper branch of the sun's hour circle is shown as a solid line. The angle, or arc of the celestial equator, between the Greenwich meridian and the sun's hour circle is 90°. Therefore, GHA of the sun at this instant is 90°. Remember, GHA is always measured westward from G.

The GHA of a star is measured in the same direction from Greenwich to the star. Because the SHA enters the picture here, however, your method of locating a star on the time diagram is somewhat different.

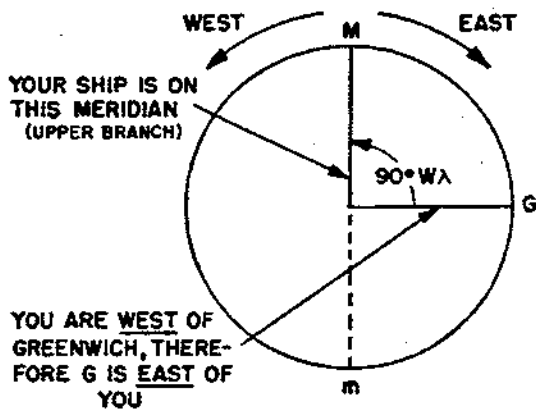

Figure 2-10-Locating G on the time diagram. Ship in  $90^{\circ}$  W.

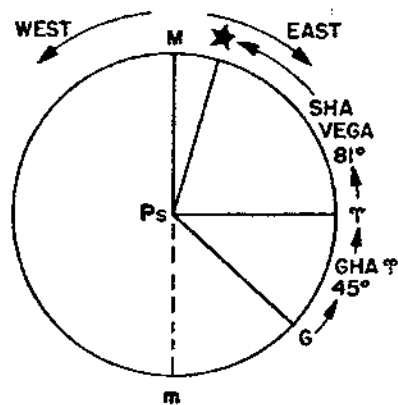

Figure 2-12-Locating vernal equinox and star on time diagram.

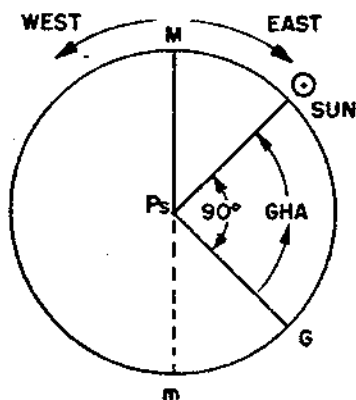

Figure 2-11-GHA of the sun on a time diagram.

First, you locate the vernal equinox by its tabulated GHA. Let's say GHA of the vernal equinox for the time of your observation is  $45^{\circ}$ . You locate the vernal equinox  $45^{\circ}$  W. from Greenwich, as shown in figure 2-12. The symbol that resembles a pair of ram's horns represents the vernal equinox.

From the Nautical Almanac you find SHA of the star in question. You already know that SHA is measured to the west from the vernal equinox. All you have to do here is find the SHA of this star, measure SHA westward from the vernal equinox, and you have the star located on the time diagram. Let's say it's the star Vega, whose SHA is approximately  $81^{\circ}$ . Figure 2-12 shows you Vega located on the time diagram.

It's easy to see here that GHA of Vega must be equal to GHA of the vernal equinox plus SHA of Vega.  $GHA \text{ (Vega)} = GHA \text{ (☉)} + SHA \text{ (Vega)}$ . In this example GHA of Vega is  $81^{\circ}$  plus  $45^{\circ}$ , or  $126^{\circ}$ .

Now let's use the time diagram to explain some more facts about nautical astronomy.

### LOCAL HOUR ANGLE (LHA)

Local hour angle is the name given to the angle of arc (expressed in degrees, minutes, and tenths of minutes) of the celestial equator between the celestial meridian of a place and the hour circle of a heavenly body. It is always measured westward from the local meridian through  $360^{\circ}$ .

Let's work this problem of LHA on a time diagram. Say you're in  $135^{\circ}$  W. longitude. You know your own meridian is represented by M. Measure approximately  $135^{\circ}$  from M toward Greenwich, which means that Greenwich will be shown eastward of M. Think it over for a moment—you're to the west of Greenwich, therefore Greenwich is to the east of you.

Now that we know where Greenwich is and where you are, let's take the sun as we had it in figure 2-11 and try to figure out its LHA. Figure 2-13 shows us that the sun is  $90^{\circ}$  west of Greenwich. We know that LHA is always measured westward from your local meridian (M) to the hour circle of the body



Another look at the diagram will show you that when the body is west of M, t is the same as LHA. (An obvious point here is that meridian angle of the sun is always east before local apparent noon and west afterwards.) It is an absolute necessity for you to know whether t is east or west. The time diagram is the best means of finding out this information.

**LEGEND: FOR TIME DIAGRAMS**

- M - Upper branch of observer's meridian
- m - Lower branch of observer's meridian
- G - Upper branch of Greenwich meridian
- g - Lower branch of Greenwich meridian
- ☉ - Hour circle of sun
- ♈ - Hour circle of First Point of Aries
- ★ - Hour circle of star
- Ps - South Celestial pole
- λ - Longitude
- GHA - Greenwich hour angle
- LHA - Local hour angle
- t - Meridian angle
- SHA - Sidereal hour angle

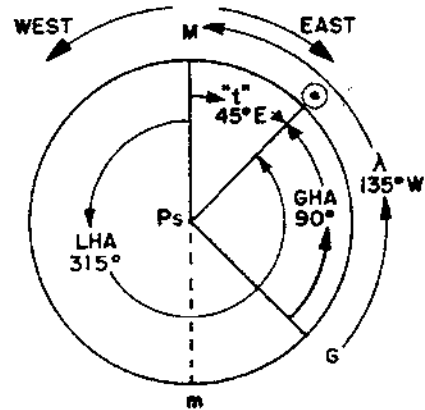

Figure 2-15-Meridian angle (t), with sun E. of M.

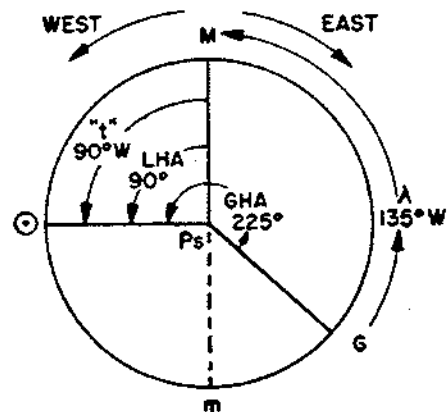

Figure 2-16-Meridian angle (t), with sun W. of M.

t = LHA, if LHA is less than 180 degrees  
 t = 360 - LHA, if LHA is greater than 180 degrees  
 If t = LHA, t is west  
 If t = 360 - LHA, t is east

## SELF-QUIZ #2

1. To determine the correct time aboard ship for celestial observation, you should use the \_\_\_\_\_.

- A. stopwatch
- B. chronometer
- C. comparing watch
- D. wrist watch

2. Time using the observer's position as a reference is called \_\_\_\_\_ time.

- A. solar
- B. sidereal
- C. zone
- D. local mean

3. The equation of time is tabulated for each day in the \_\_\_\_\_.

- A. Light List
- B. Nautical Almanac
- C. Tide Table
- D. Sight Reduction Table

4. The difference between mean and apparent time at any instant is called \_\_\_\_\_ time.

- A. equation of
- B. sidereal
- C. zone
- D. ship's

5. The time used in figuring position by celestial navigation is

- A. ZT
- B. GMT
- C. LMT
- D. LST

6. The basic relationship between time and arc is that 1 hour of time equals \_\_\_\_\_ of longitude (arc).

- A. 4'
- B. 4<sup>o</sup>
- C. 15<sup>o</sup>
- D. 15'

7. When you convert 6 hours 07 minutes and 24 seconds of time into arc, you have \_\_\_\_\_.

- A. 91<sup>o</sup> 45' 06"
- B. 90<sup>o</sup> 25' 45"
- C. 90<sup>o</sup> 51' 00"
- D. 91<sup>o</sup> 51' 00"

8. The amount a chronometer gains or loses each day is its \_\_\_\_\_.

- A. variation
- B. error
- C. rate
- D. correction

9. Your ship is in position 34<sup>o</sup>24'15"N, 112<sup>o</sup>28'45"E. In what time zone is the ship located?

- A. +8
- B. -8
- C. +7
- D. -7

## ANSWERS TO SELF-QUIZ #2

QUESTION	ANSWER	REFERENCE
1	B	2-5
2	D	2-6
3	B	2-2
4	A	2-2
5	B	2-4
6	C	2-7
7	D	2-8
8	C	2-10
9	D	2-5

## MARINE SEXTANT/RUDE STARFINDER

Reading Assignment: 3  
Pages 3-1 through 3-21

### OBJECTIVES

To successfully complete this assignment, you must study the text and master the following objectives:

1. State the main uses of the sextant.
2. List the principal parts of the sextant.
3. List the corrections applied to the sextant altitude in order to obtain the observed altitude.
4. Explain the proper method of using the sextant to take altitude observations.
5. Explain how to properly care for the sextant.
6. Describe the Rude starfinder.
7. Explain how to use the Rude starfinder to determine:
  - a. which navigational star(s) to use at a given DR position and time.
  - b. the apparent altitude and true azimuth of a listed navigational star.
  - c. the apparent altitude and true azimuth of a navigational planet.
  - d. the altitude and true azimuth of an unlisted star, the sun, and the moon.
  - e. the identity of an unknown body.

### MARINE SEXTANT

The sextant (figure 3-1) is used to measure altitudes of celestial bodies above the visual horizon. Measurement is effected by bringing into coincidence the images, one direct and one reflected, of the visual horizon and the celestial body. The sextant was so named because its arc represents approximately one-sixth of a circle. Nevertheless, because of its optical principle of double reflection as briefly described the sextant can usually measure twice as much arc, or something greater than a third of a circle. Its optical principle was first described by Sir Isaac Newton and later independently rediscovered in 1731 by Hadley in England and Godfrey in Philadelphia.

The marine sextant consists of the following parts:

- A. Frame - Support for other parts.
- B. Limb - An arc (approximately 1/6 of a circle) graduated in degrees.
- C. Index arm - Arm pivoting from center of curvature; lower end indicates reading on limb and mounts the micrometer drum.
- D. Micrometer - Provides a scale for reading minutes and tenths of minutes.

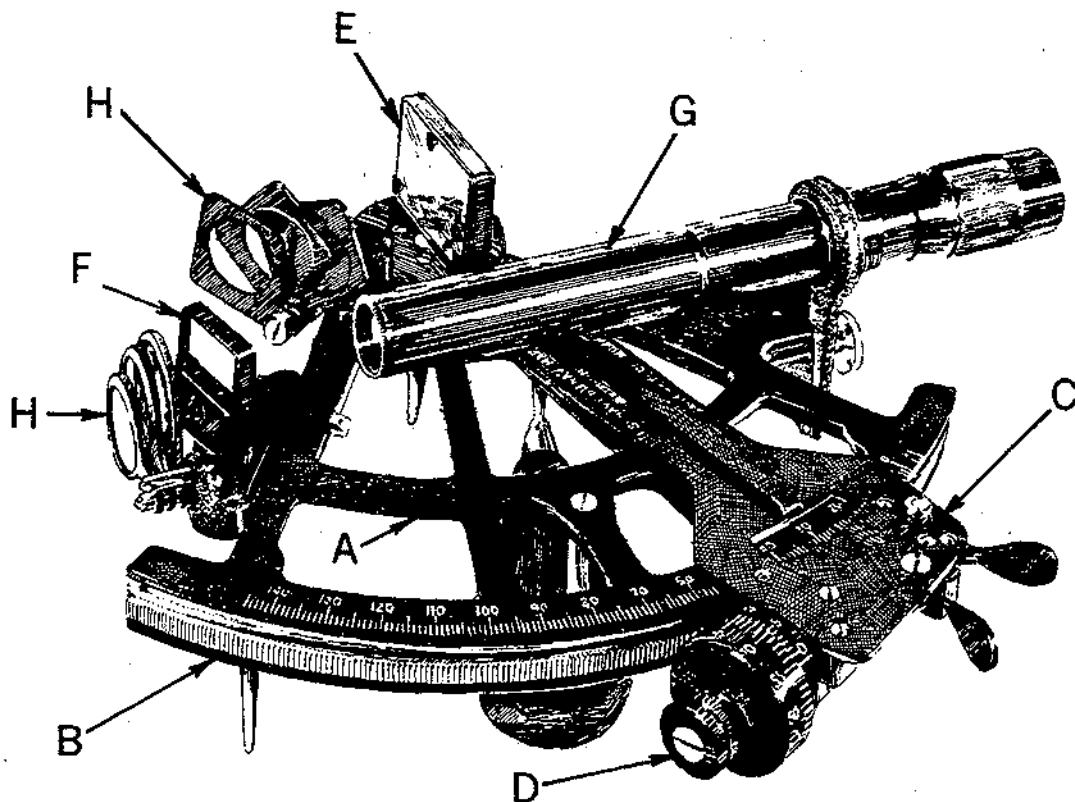

Figure 3-1. - Micrometer sextant.

E. Index mirror - Mirror on upper end of index arm which is perpendicular to the plane of the limb.

F. Horizon glass - A glass window, the left half of which is clear glass and the right half a mirror, mounted on frame and parallel to the index mirror at an instrument setting of 0 degrees. .

G. Telescope - Inserted in collar attached to frame to magnify field of vision.

H. Index and horizon filters (in some instruments, shades).

The optical principle upon which the sextant is based is that the angle between the first and last direction of a ray of light that has undergone two reflections in the same plane is twice the angle that the two reflecting surfaces make with each other.

To make a reading with the sextant, set the index arm to 0 degrees. Look through the mirror half of the horizon glass at the celestial body which also appears in the clear glass half. Move the index arm forward

slowly, at the same time tilting the instrument forward, until the reflected image is in coincidence with the horizon. Fine adjustment may then be made using the micrometer drum on the index arm. Read altitude in degrees on the limb, read minutes on the forward movable part of the drum at the 0 mark, and read tenths of a minute on the micrometer scale (which makes a 10:9 ratio with the minutes scale).

In observing a star or a planet, bring the center of the star or planet into coincidence with the horizon. In the case of the sun, normally the lower limb (lower edge) is brought into coincidence; however, if the upper limb is more clearly defined, an upper limb shot may be taken if so identified. Moon observations, like sun observations, may be of either limb.

In observing stars, if difficulty is experienced in bringing stars to the horizon, the instrument may be inverted and the index arm moved to bring the horizon up to the celestial body without any tilt of the instrument or movement of the field of vision.



When the horizon is "fuzzy," or indefinite directly beneath a celestial body, the navigator may face the reciprocal of its azimuth and use the sextant to measure the supplement of the altitude. When this is done in the case of the sun or the moon, if a lower limb observation is desired the navigator makes what appears to him to be an upper limb observation, otherwise he must add the sun's (or moon's diameter) to the sextant reading.

Sextants are equipped with colored filters or shades for sun observations. These lenses protect the navigator's eyes from the bright rays of the sun.

An excellent marine sextant used today is known generally as the endless tangent screw sextant.

## SEXTANT ADJUSTMENT

The accuracy of the sextant depends upon the exact adjustment and alignment of its various parts. A slight shock, for instance, can disturb the adjustment enough to produce a significant error.

For this reason, the different errors of the sextant and how to correct these errors are discussed here.

The adjustable errors in the sextant (figure 3-1) are those related to "perpendicularity" (at right angles to) of the frame (A) and the index mirror (E), and the frame to the horizon glass (F); "parallelism" of the index mirror (E) and horizon glass (F) to each other at zero setting, and the telescope (G) to the frame. Each of these errors, if it exists can be removed from the sextant by careful adjustment. In making these adjustments, never tighten an adjusting screw without first loosening the other screw which bears on the same surface. The adjustments should be made in the order indicated in the following paragraphs.

The first adjustment is for perpendicularity of the index mirror to the frame of the sextant. To test for perpendicularity, place the index arm at about  $35^{\circ}$  on the arc, and hold the sextant on its side, with the index mirror "up" and toward the eye. Observe the direct and reflected views of the

sextant arc, as illustrated in figure 3-2. If the two views do not appear to be joined in a straight line, the index mirror is not perpendicular. If the reflected image is above the direct view, the mirror is inclined backward. An alternative and sometimes more satisfactory method of determining perpendicularity involves the use of two small vanes, or similar objects, of exactly the same height. Figure 3-3 illustrates this method. Again the index arm is set at about  $35^{\circ}$ . The vanes are placed upright on the extremities of the limb in such a way that the observer can, by placing his eye near the index mirror, see the direct view of one vane and the reflected image of the other. The tops of the objects are then observed for alignment. The use of vanes permits observation in the plane of adjustment, rather than at an angle. Adjustment is made by means of two screws at the back of the index mirror.

The second adjustment is for perpendicularity of the horizon glass (F) to the frame (A) of the sextant. An error resulting from the horizon glass not being perpendicular is called side error. To test for perpendicularity, set the index arm at zero and direct the line of sight at a star. Then rotate the tangent screw back and forth so that the reflected image passes alternately above and below the direct view. If, in changing from one position to the other, the reflected image passes directly over the star as seen without reflection, no side error exists. But if it passes to one side, the horizon glass is not perpendicular to the frame of the sextant. Figure 3-4 illustrates observations without side error (left) and with side error (right). Whether the sextant reads zero when the true and reflected images are in coincidence is immaterial in this text. An alternative method is to observe a vertical line, such as one edge of the mast of another vessel (or the sextant can be held on its side and the horizon used). If the direct and reflected portions do not form a continuous line, the horizon glass is not perpendicular to the frame of the sextant. A third method is to hold the sextant vertically, as done in observing the altitude of a celestial body, and bring the reflected image of the horizon into coincidence with the direct view, so that it appears as a continuous line across the horizon glass. Then tilt the sextant right or left. If the horizon

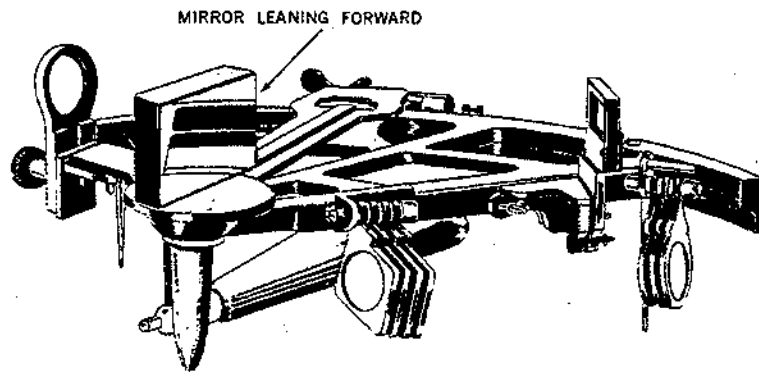

Figure 3-2. - Testing the perpendicularity of the index mirror. Here the mirror is not perpendicular.

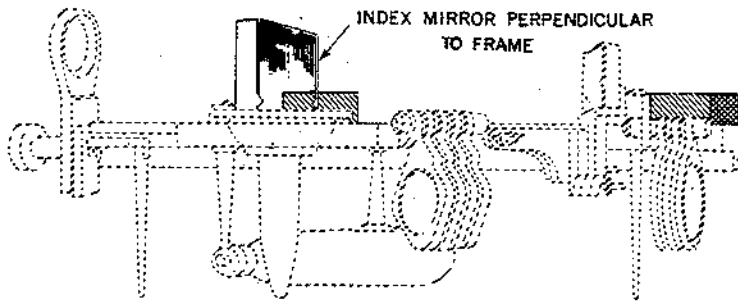

Figure 3-3. - Alternative method of testing the perpendicularity of the index mirror. Here the mirror is perpendicular.



Figure 3-4. - Testing the perpendicularity of the horizon glass. Left, side error does not exist. Right, side error does exist.

still appears continuous, the horizon glass is perpendicular to the frame, but if the reflected portion appears above or below that part seen directly the glass is not perpendicular. Adjustment is made by using the two screws near the base of the horizon glass.

The third adjustment is to make the index mirror and horizon glass parallel when the index arm is set exactly at zero. The error which results when the two are not parallel is the principal cause of index error, the total error remaining after the four adjustments have been made. Index error should be determined each time the sextant is used and need not be removed if its value is known accurately. To make the test for parallelism of the mirrors, set the instrument at zero, and direct the line of sight at the horizon or a star. Side error having been eliminated, the direct view and reflected image of the horizon appear as a continuous line, or the star as a single point, if the two mirrors are parallel. If the mirrors are not parallel, the horizon appears broken at the edge of the mirrored part of the horizon glass, one part being higher than the other. The reflected image of a star appears above or below the stars seen without reflection. If the star appears as a single point, move the

tangent screw a small amount to be sure both direct view and reflected image are in the range of vision. The sun can be used by noting the reading when the reflected image is tangent to the sun as seen direct, first above it and then below. These should be numerically equal but of the opposite sign (one positive and the other negative). To avoid variations in refraction, do not use low altitudes or turn the sextant on its side and use the two sides of the sun. Adjustment is made by two screws near the base of the horizon glass (F). If the error is not removed, turn the tangent screw until direct view and reflected image of the horizon or a star are in coincidence. The reading of the sextant is the index error. It is positive if the reading is "on the arc" (positive angle), and negative if "off the arc" (negative angle). Index correction (IC) is numerically the same as index error, but of the opposite sign. Since both the second and third adjustments involve the position of the horizon glass, you should practice rechecking side error after index error has been eliminated. Index error should always be checked after adjustment for side error.

The fourth adjustment is to make the telescope (G) parallel to the frame (A) of the sextant. If the line of sight through the telescope is not parallel to the plane of the instrument, an error of collimation will result, and altitudes will be measured as greater than their actual values. To check for parallelism of the telescope, insert it in its collar, and observe two stars 90° or more apart, bringing the reflected image of one into coincidence with the direct view of the other, near either the right or left edge of the field of view (the upper or lower edge if the sextant is horizontal). Then tilt the sextant so that the stars appear near the opposite edge. If they remain in coincidence, the telescope is parallel to the frame, but if they separate, it is not. An alternative method is to place the telescope in its collar and then lay the sextant on a flat table. Sight along the frame of sextant and have an assistant place a mark on the opposite bulkhead in line with the frame. Place another mark above the first at a distance equal to the distance from the center of the telescope to the frame. This second line should be in the center of the field of view of the telescope if the telescope is parallel to

the frame. Adjustment for nonparallelism is made to the collar, by means of the two screws provided for this purpose.

Determination of all errors should be based upon a series of observations, rather than a single one. This is particularly true in the case of index error which should be determined by approaching coincidence from opposite directions (up and down) on alternate readings. If adjustments are made carefully and the sextant is given proper handling, it should remain in adjustment over a long period of time. Unless the navigator has reason to question the accuracy of the adjustments, they need not be checked at intervals of less than several months, except in the case of index error, which has the greatest effect on accuracy of readings, and which should be checked each time the sextant is used. If the horizon is used for determining index error, this check should be made before evening twilight observations and after morning twilight observations while the horizon is sharp and distinct. If a star is used, the index error should be determined after evening observations and before morning sights are taken. During the day, it should be checked both before and after observations.

Frequent manipulation of the adjusting screws should be avoided, as it may cause excessive wear. Except in the case of index error, slight lack of adjustment has little effect on the results and should be ignored. If adjustments are needed at frequent intervals, the sextant is not receiving proper care or has worn parts which should be replaced at a navigation instrument shop. If index error is not constant, it should not be removed. But index correction should be determined before or after every observation and applied to the readings until the sextant can be repaired. A small variable error might well be accepted, but should be watched to see that it does not become unduly large.

When it is impossible for you to adjust a sextant even after following the steps above; you should take the sextant to an instrument repair shop. Repair shops are usually found at most naval bases or aboard naval repair ships. If these are not available you may have a civilian repair shop in the area. When you take a sextant to the repair shop you should have the person making the adjustments show

you the adjustment procedures.

## CELESTIAL NAVIGATION

Celestial navigation is a most exacting science that requires precise and accurate application of all values, terms, and definitions in determining position by observations of celestial bodies. In studying this section, you should refer to Dutton, Mixer, Bowditch, and Hobbs.

Older methods of navigation required that the navigator possess an extensive background in mathematics. Although the recently developed short tabular methods dispense with a good deal of the mathematics previously considered essential to working sights, a good foundation in mathematics is definitely helpful. Lack of knowledge of the subject in its advanced phases is no great handicap. There are calculators that have the capacity to compute celestial observations, too.

### ALTITUDE DEFINITIONS

The sextant is the instrument used to measure the altitude of a heavenly body above the visible horizon. Sextant altitude is corrected for various factors in order to determine the body's true (or corrected) altitude above the celestial horizon. Before you go into the correction problem, the definition of these terms must be thoroughly understood.

The sextant altitude, ( $h_s$ ) or altitude of a body above the visible horizon, is the sextant reading without correction.

The observed altitude ( $h_o$ ) (true altitude) is the altitude of the center of the observed body above the celestial horizon. It is obtained by applying all the corrections to the sextant altitude.

### ALTITUDE CORRECTIONS

Of the following five altitude corrections, the first three apply to observations of all celestial bodies. The last two apply only when the observed body belongs to the solar system. Figure 3-5 illustrates the correction problem. To obtain the true altitude, the sextant altitude of any celestial body must be corrected for-

**INDEX ERROR, (IC)** the inherent error of the sextant used.

**REFRACTION**, the deviation of rays of light from a straight line caused by the atmosphere.

**DIP OF THE HORIZON**, the difference in direction between the visible and celestial horizons caused by the observer's height above the surface.

If the observed body belongs to the solar system, these errors must also be corrected for:

**PARALLAX**, caused by the proximity of bodies of the solar system to the earth resulting in a difference in altitudes measured from the surface of the earth and from the center of the earth. Such an occurrence is not true of other heavenly bodies whose distance from the earth is considered infinite.

**SEMIDIAMETER**, results from the nearness of bodies of the solar system. The bodies must be considered as being of appreciable size instead of mere points of light (stars, for example). The sextant altitude of such a body is obtained by bringing its disk tangent to the horizon. Semidiameter correction must be applied to find the altitude of the center.

### INDEX CORRECTION (IC)

An error, known as the index error, is introduced if there is a small lack of parallelism of the horizon glass. Index correction is resolved by the following procedure:

Set the sextant near zero. Hold the sextant vertically and sight toward the horizon. Use the micrometer drum to bring the direct and reflected horizon exactly in line. (See figure 3-6.) If the sextant reading is zero, there is no error. If the reading is not zero, the amount of error is the index correction. If the index mark is to the left of the zero on the arc of the limb, then the reading is too large, and this index correction must be subtracted from the sextant altitude. If the index mark is to the right of zero (off the arc), the reading is too low, and this amount must be added to the sextant

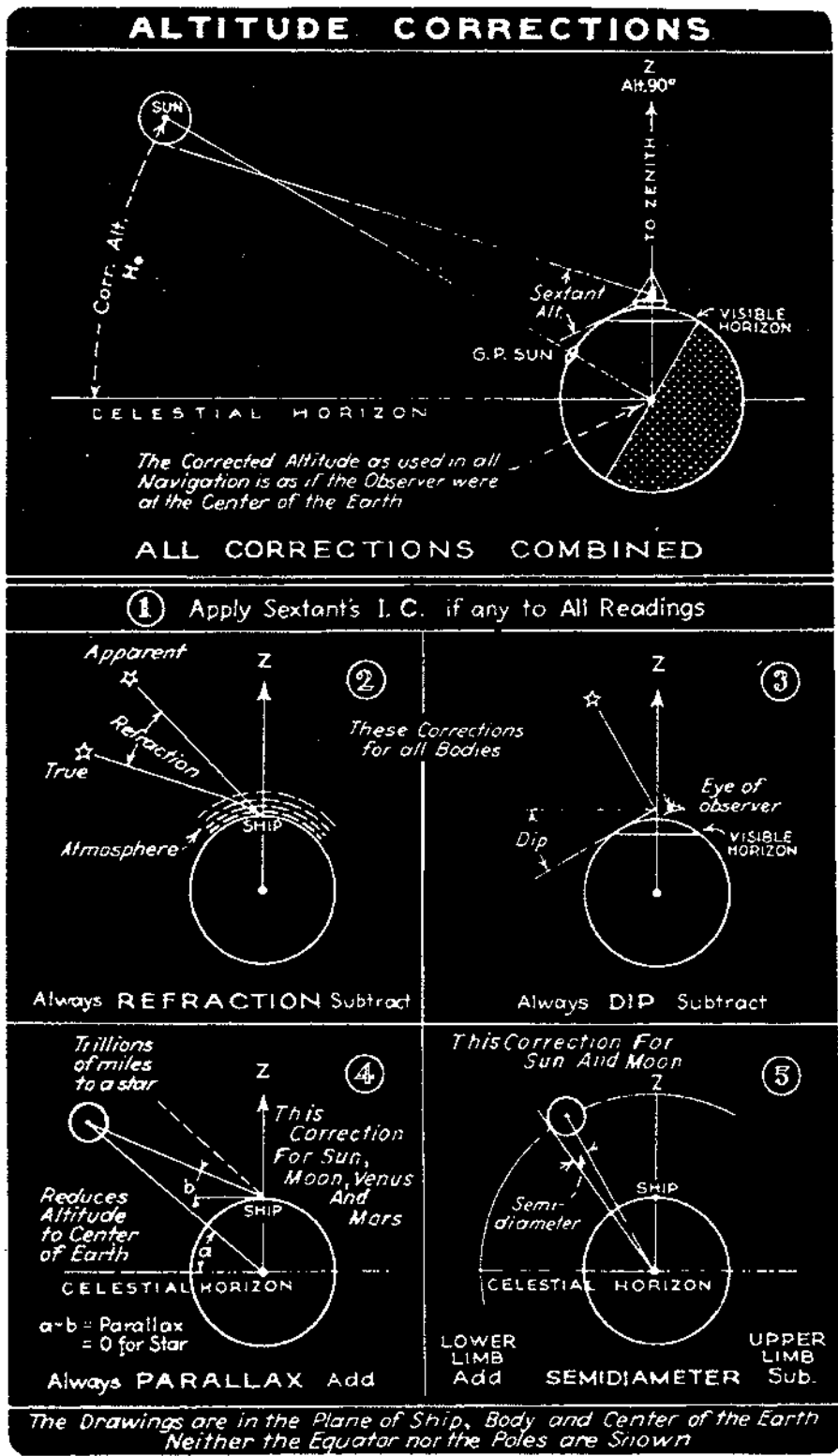

Figure 3-5. - Altitude corrections.

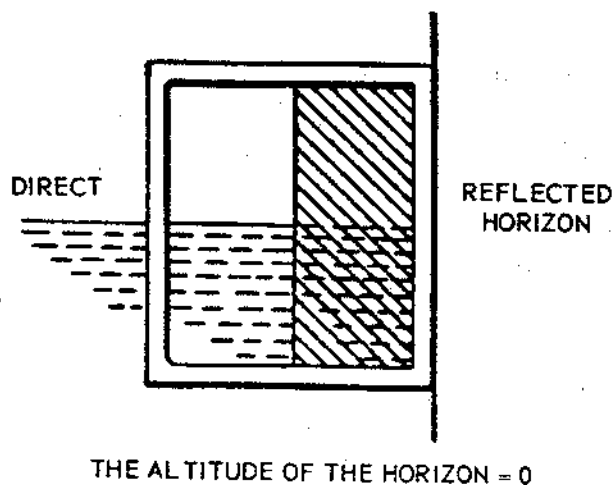

Figure 3-6. - Altitude of the horizon.

altitude. Rule: if it's on (the arc), it's off; if it's off (the arc), it's on.

If the index mark is on the arc, the sextant is read in the usual way. The reading is the index correction to be subtracted. Always read the mark that is on the arc of the limb to the right of the index mark. In figure 3-7 the index mark points to the right of the zero (off the arc) to a spot between the  $1^{\circ}$  and  $2^{\circ}$  mark. The  $2^{\circ}$  mark must be used. On the drum the 16 mark lies below the 0 mark on the vernier, hence the reading in minutes is 16. The mark above the 0 mark on the vernier that coincides most nearly with a mark on the drum is the 3 mark. Thus, the remainder of the reading is 0.3 minute. The combined drum and vernier reading tells you how much the index mark is to the left of the  $2^{\circ}$  mark on the arc of the limb. The result obtained by subtracting 16.3' from  $2^{\circ}$  is your index correction of  $1^{\circ} 43.7'$ . Because the reading is off the arc,  $1^{\circ} 43.7'$  must be added to the sextant altitude.

## REFRACTION

The earth is wrapped in a blanket of atmosphere more than 50 miles deep. Density of the atmosphere, like that of the ocean, increases with depth and is greatest at the bottom, next to the earth's surface. Light rays do not follow a straight line when passing obliquely through atmospheric strata of different densities, but are slightly bent into a gentle arc. This phenomenon is called

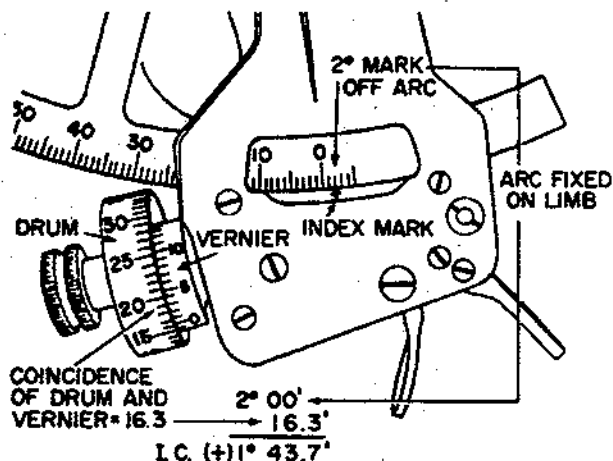

Figure 3-7. - Reading off the arc

refraction. Refraction is defined as the deviation of light rays from a straight line caused by their passage obliquely through mediums of different density. The measure of refraction is the angular difference between the apparent rays of light from an observed celestial body and its true direction.

The effect of refraction is always to make the observed altitude greater than the true altitude. Consequently, refraction correction is always subtracted from the sextant altitude. Since refraction is caused by the oblique passage of rays through the atmosphere, rays from a body in the observer's zenith, intersecting the atmospheric strata at right angles, are not refracted. Maximum refraction occurs when a body is on the horizon, amounting then to between 34' and 39'; the amount depends on atmospheric conditions. Density of the atmosphere varies with barometric pressure and temperature. Refraction varies with density and also with the body's altitude.

Because refraction varies with atmospheric conditions, and the effect of atmospheric conditions at low altitudes cannot be estimated with complete accuracy, you should regard observations of bodies below  $10^{\circ}$  with suspicion. Refraction has no effect upon the azimuth of a celestial body, because it takes place entirely in the vertical plane of passage of the light rays.

## DIP OF THE HORIZON

The higher an observer's position is above the surface, the more the observer must lower (or dip) the line of vision to see the horizon. Logically, then, all altitude observations must be corrected for height of eye. Refer again to figure 3-5, and you will see why a dip correction is always subtracted.

Failure to correct for dip from a height of 10 feet would result in an error of 3 miles in line of position. From the bridge of the average ship, the resulting error would be approximately 6 miles.

## PARALLAX

Parallax is the difference between the altitude of a body, as measured from the earth's center, and its altitude (corrected for refraction and dip), as measured from the earth's surface. Altitude from the center of the earth is bound to be greater than from the surface. Consequently, parallax is always a plus correction.

Parallax increases from  $0^{\circ}$  for a body directly overhead to a maximum for a body whose altitude is  $0^{\circ}$ . In the latter instance, it is called horizontal parallax (HP). Parallax of the moon is both extreme and varied, because of its changing distance from the earth in its passage through its orbit. Parallax of the sun is small, and that of the planets is even smaller. For the stars, parallax is so tiny it is negligible.

## SEMIDIAMETER

The true altitude of a body is measured to the center of that body. Because the sun and moon are of appreciable size, you normally observe the lower limb. Therefore, the semidiameter correction must be added. Consequently, if the upper limb of either body is observed, the semidiameter correction is minus. Semidiameter correction is important amounting to about 16' for either the sun or moon. Stars are considered as points, and, as such, they require no semidiameter correction. When observing a planet, the center of the planet is visually estimated by the observer, so that a semidiameter correction does not exist.

In concluding the subject of altitude corrections, mention should be made that some tables for altitude corrections (in the Nautical Almanac, for example) combine two or more of the corrections for refraction, parallax, and semidiameter. The correction for height of eye (dip) appears in a separate table for use with all bodies. Index error, which is impossible to include in such tables, should always be determined, recorded, marked plus or minus, and applied ahead of any other tabulated corrections.

## OBSERVING THE SUN

At this point, a few words on the general technique of observing the sun with a sextant might not be amiss. Experience, of course, is the only way to gain real proficiency in shooting the sun or any other body.

First, the navigator keeps both eyes open when observing the sun. You had better do the same, because the strain on the eyes is considerably less that way. When a telescope is used, focus it properly before you start. This adjustment is accomplished by observing a distant object and moving the eyepiece in or out until the image is clear. Then, check the index correction.

Next, select the shade glasses you want to use, and turn them into position in front of the index glass. Sometimes they are slightly prismatic, so you should recheck the index error after they are set. If the telescope is equipped with polarizing filters instead of shade glasses, adjust the filters as necessary.

Hold the sextant vertically, and train the line of sight on that point of the horizon just below the sun. Then, beginning with zero position, move the index arm slowly outward until the image of the sun appears in the mirror of the horizon glass. Continue moving the arm until the sun's lower limb is nearly tangent to the horizon, as in figure 3-8.

Before moving the micrometer drum in order to bring the sun's lower limb exactly tangent to the horizon, you must ascertain whether you actually are holding the sextant vertically. Rotate the sextant slowly through a small arc about the line of sight. As you do so, the sun's image moves in a small arc

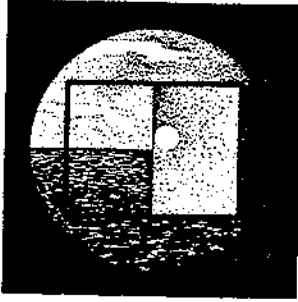

Figure 3-8. - Observing the sun's lower limb.

convex to the horizon. At the point where the image is lowest, the sextant is held vertically. This procedure, called swinging the arc, should be followed every time an observation is taken. If the sextant is not held vertically, the angle measured will be between the observed body and a point on the horizon that is not exactly below it, so that the altitude measured will be inaccurate.

If you have an assistant taking the time, warn that person to stand by with the watch. Move the micrometer drum (or tangent screw if a vernier sextant) until the sun's lower limb is in contact with the horizon, and at the instant of contact sing out "Mark!" At this word, your helper notes the time to the second. Again swing the arc, without moving the micrometer drum or tangent screw, to make sure you were holding the instrument vertically at the time of observation.

Until you become fairly proficient, you should take a series of observations (perhaps five), as rapidly as you can get them, with an accurate time on each. Of the five, usually there are about three between which the change in altitude is directly proportional to the elapsed time. Discard the observations between which the proportion is inaccurate, and use any one of the correct observations. Or you can take a mean of their observed altitudes together with a mean of the recorded times. For example, consider the accompanying Table of Observations.

From the table, you should be able to determine that the change of altitude is directly proportional to the elapsed time for the first three observations, but it is drastically out of order for the last two.

The foregoing method of obtaining an accurate observation is especially useful when the ship is rolling or pitching heavily, or when other conditions make observation difficult and uncertain. Don't use it when the observed body is near the meridian, though, because then the change of altitude is proportional to the square of the difference of time. A method called reduction to the meridian is suitable for that situation. It is described later.

Brightness of the reflection from the horizon glass may be varied by moving the telescope toward or away from the plane of the instrument. Slacken the set-screw of the telescope carrier, adjust the telescope as desired, and set up the screw again. Moving the telescope away from the plane of the limb causes more light to enter from the unsilvered part of the horizon glass and less light from the mirror part. This movement, in turn, makes the horizon relatively brighter and the reflected celestial body dimmer. Such a state of affairs is helpful in the darker twilight, when the horizon is difficult to see but the stars are bright.

Moving the telescope toward the plane of the limb reverses the effect just described. As a result, more light is reflected from the mirrored part of the horizon glass. This procedure is desirable during the brighter twilight when the horizon is clear but the stars still are faint.

### OBSERVING THE MOON

Formerly, considerable prejudice existed against the moon as a navigational body because of the difficulty in trying to reduce lunar movements to a definite pattern. Recent tabulations make the calculation of the moon's declination and hour angle possible without any difficult interpolation.

Using the moon for observations has definite advantages. However, it often gives you a line of position when one cannot be obtained by means of another celestial body. Frequently, the moon may be observed during daylight, at twilight, or occasionally after dark, when its light illuminates the horizon. But, because of the varying shape of the moon's disk and/or cloud cover, you may have



Table of Observations

Watch time	Interval (seconds)	Sextant altitude	Increase (minutes)	Seconds per 1' of altitude
9-30-31	- -	48°10.0		
9-31-16	45s	48°17.7	7.7'	6
9-32-06	50s	48°26.2	8.5'	6
9-32-40	34s	48°34.4	8.2'	4
9-33-07	27s	48°37.4	3.0'	9

to observe the upper limb instead of the lower limb.

### OBSERVING STARS AND PLANETS

The technique of bringing down or pulling down a star or planet is similar to shooting the sun, except that no shade glasses are required. Because a star telescope is more powerful than an ordinary telescope, erecting lenses are dispensed with so that the light may be decreased as little as possible, and the stars are viewed through an inverting telescope. But, because the inverting telescope is confusing to a beginner, you should rely on an ordinary telescope. It produces entirely satisfactory results, and navigators, for the most part, prefer it to the inverting star telescope.

Once you identify the star you want, the chief difficulty in pulling down the star stems from the likelihood of losing sight of it when you direct your line of sight to the horizon. Often the star is dim and the reflection may not be easy to identify. Besides, during early morning or late twilight, more than one star may appear in the field of the telescope, and you may be unable to tell which one you intended to observe.

To keep track of your star, the following procedure is recommended. Set the sextant at approximately zero, and direct the line of sight at the star. The star should then be nearly coincident with its image (figure 3-9). Hold the sextant approximately in the

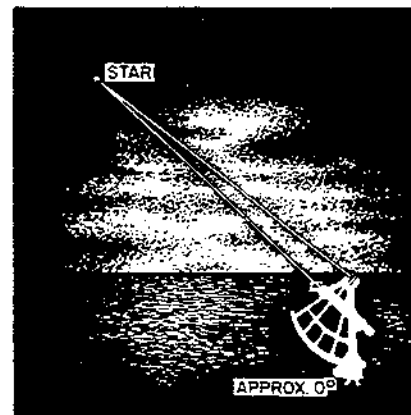

Figure 3-9. - Shooting a star.

plane of the star's vertical circle, and move the index arm slowly outward, causing the star's image to move downward. As you move the arm outward, move the horizon glass downward so as to keep the star's image in the glass. When the index arm moves to the reading of the star's approximate altitude, the horizon shows up in the clear half of the horizon glass. Set the index arm clamp, and proceed as described for the sun. To avoid bringing down the wrong star, keep both eyes open when observing a star.

Many navigators prefer a second method of bringing down a star. It consists essentially of bringing the horizon up instead. For this method, set the arm near to zero, invert the sextant, and direct the line of sight at the star. You will see the star in the

clear part of the horizon glass. Move the index arm until you bring the horizon up to the star, then clamp the arm.

With the index arm set at the approximate altitude, the sextant is turned right side up, and the altitude is observed in the usual manner. In this method, the desired star is kept constantly in direct view as opposed to reflected view. You may have some slight difficulty picking up the star again after you right the sextant. However, if you train on the proper bearing, it should appear in the horizon mirror. Most navigational stars are far enough apart so that no other bright star is likely to show up near the same azimuth at the approximate altitude set.

Whenever possible, you should plan the order of taking sights so that you can take maximum advantage of horizon conditions. For example, during morning sights, you should observe dimmer stars to the east before the horizon becomes too bright. Then, observe stars to the west while that horizon still is good.

### IDENTIFICATION OF CELESTIAL BODIES

In order to solve the navigational triangle, the navigator must know the name of the celestial body observed, so that its GHA and declination from the almanac can be obtained. You will have no difficulty in identifying the sun or moon, but the stars and planets can present a problem. Both appear to be point sources of light, and the only apparent differences between any two are in position, brightness, and obviously, color.

The usual procedure in identifying stars and planets is to select, in advance of twilight, a number of these bodies, so located that lines of position obtained from them will result in a good fix. Occasionally, you will observe an unknown body and identify it afterward.

Visual identification is the most efficient method of locating celestial bodies, and most experienced navigators pride themselves on their ability to do this. For the student or young navigator, however, identification is best made with a star finder.

### IDENTIFICATION BY STAR FINDER

Star finders are devices which can be used to determine the approximate coordinates of a celestial body at a given time. A number of star finders have been devised, but the one most commonly used is the Rude Star Finder and Identifier, 2102-D, published by the U. S. Naval Oceanographic Office. The Rude star finder contains a star base, on which the 57 "daily-page stars" of the almanacs are shown by name and by symbols which indicate their approximate magnitudes (first, second, or third); nine latitude templates which you can use to determine the horizon system coordinates of celestial bodies; and a tenth template which you can use to determine the celestial equator system coordinates of celestial bodies, and to plot additional bodies on the star base.

The Rude star base is a white plastic disc about 8 1/2 inches in diameter. The north celestial pole is shown at the center of one side of the base and the south celestial pole at the center of the opposite side (figure 3-10 and 3-11). On both sides of the star base, the circumference is graduated in half degrees and labeled toward the east at 5° intervals, representing the local hour angle of Aries (LHA<sup>A</sup>). The positions of the 57 stars relative to each pole are printed on each side of the star base using polar azimuthal equidistant projection. Because of the distortion of the projection, the relative positions of the stars on the star base do not correspond to their apparent positions in the sky, and the device cannot be compared with the appearance of the heavens. The nine latitude templates are constructed for 10° intervals of latitude (5°, 15°, 25°, etc.). Each one has a family of altitude and azimuth curves (printed in blue) used in conjunction with the star base to determine the approximate altitudes and azimuths of celestial bodies. (See figure 3-12.) Curves are inscribed for each 5° of altitude and of azimuth; closer approximations can be made by eye interpolation between the curves. The tenth template is printed in red with lines which indicate meridian angle and declination. (See figure 3-13.) Both sets of lines on this template are given at 10° intervals, and closer approximations can be made by eye interpolation. Each of the ten

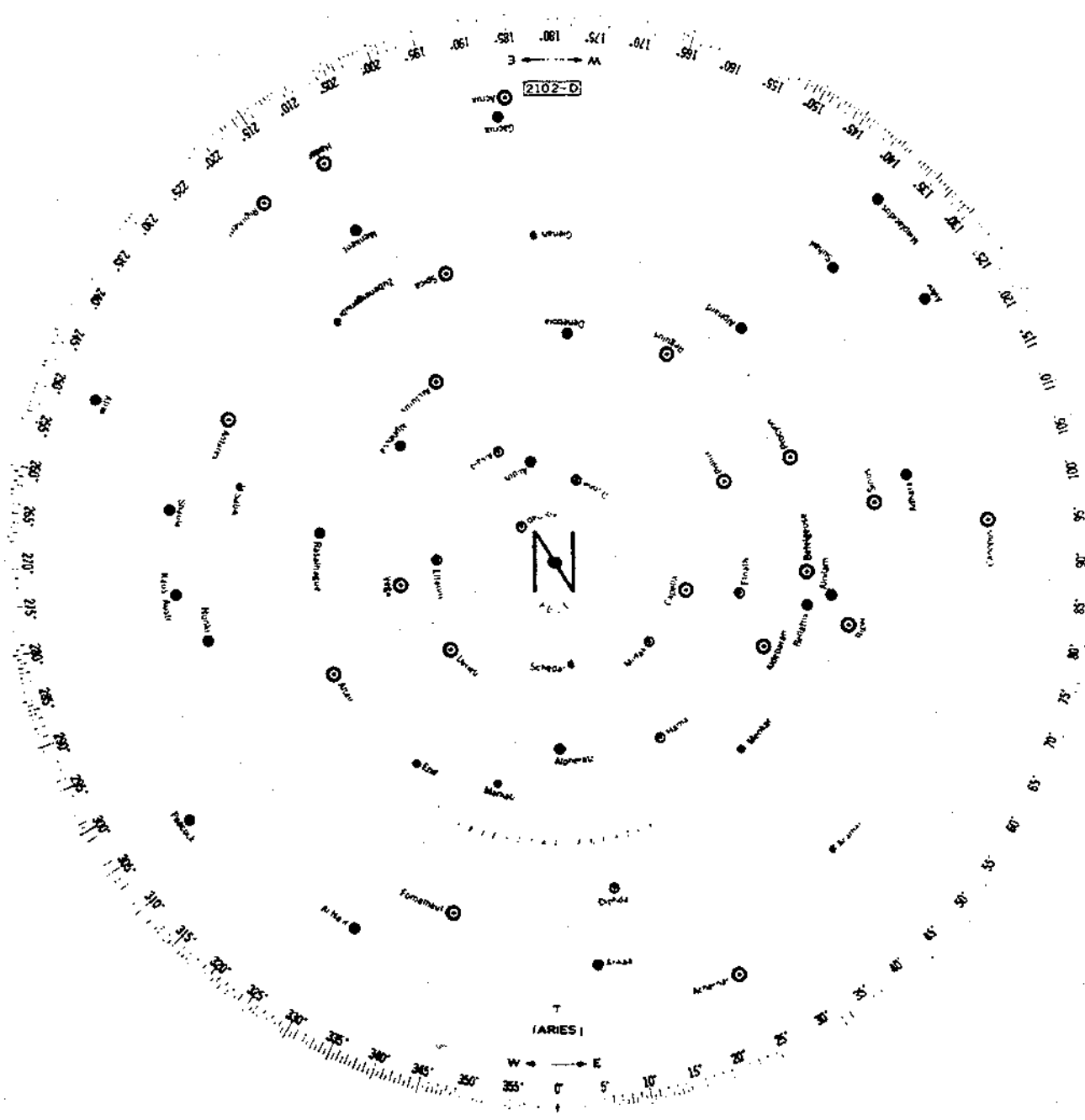

Figure 3-10. - Side of star base of 2102-D used in north latitude.

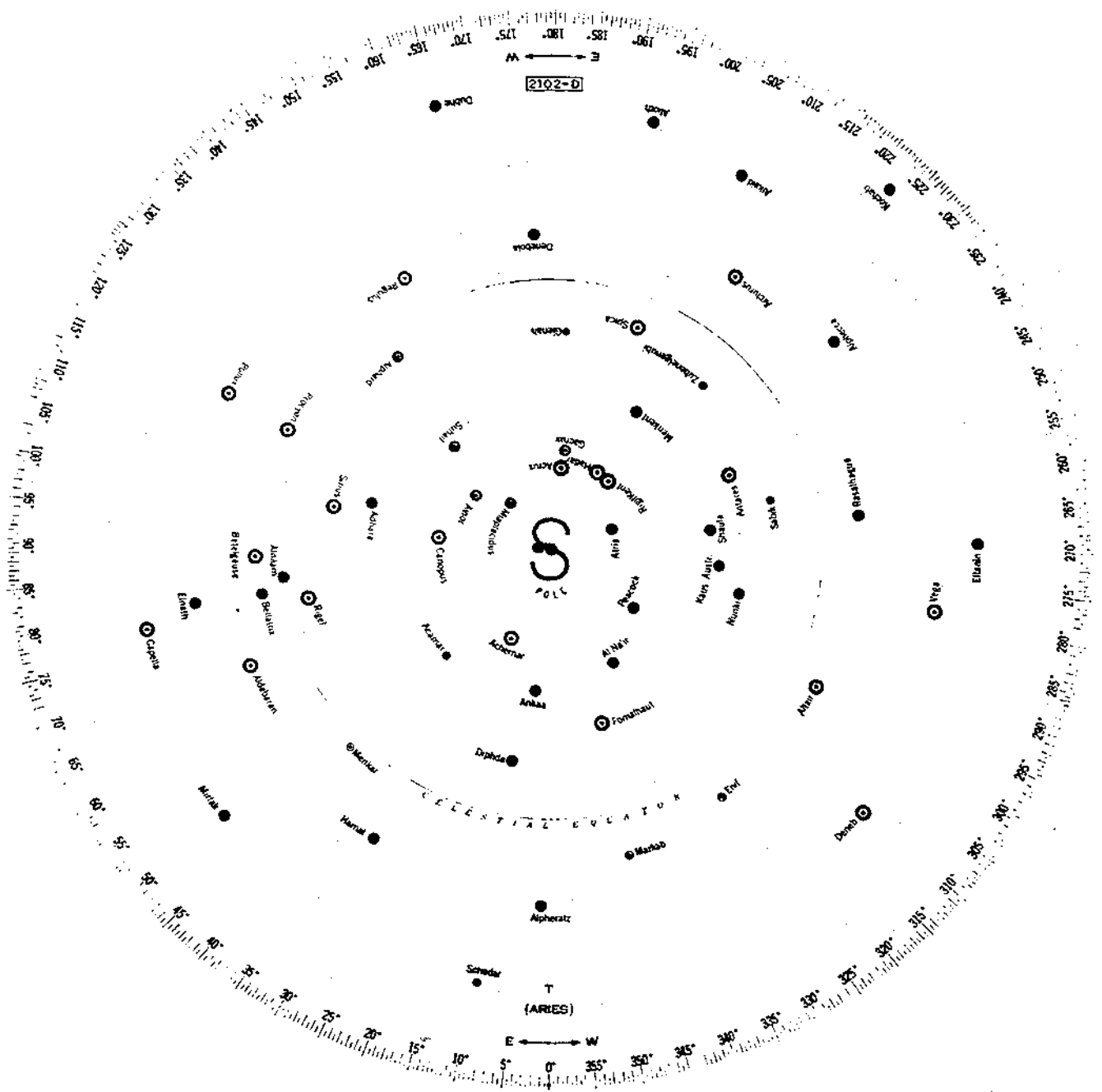

Figure 3-11. - Side of star base of 2102-D used in south latitude.

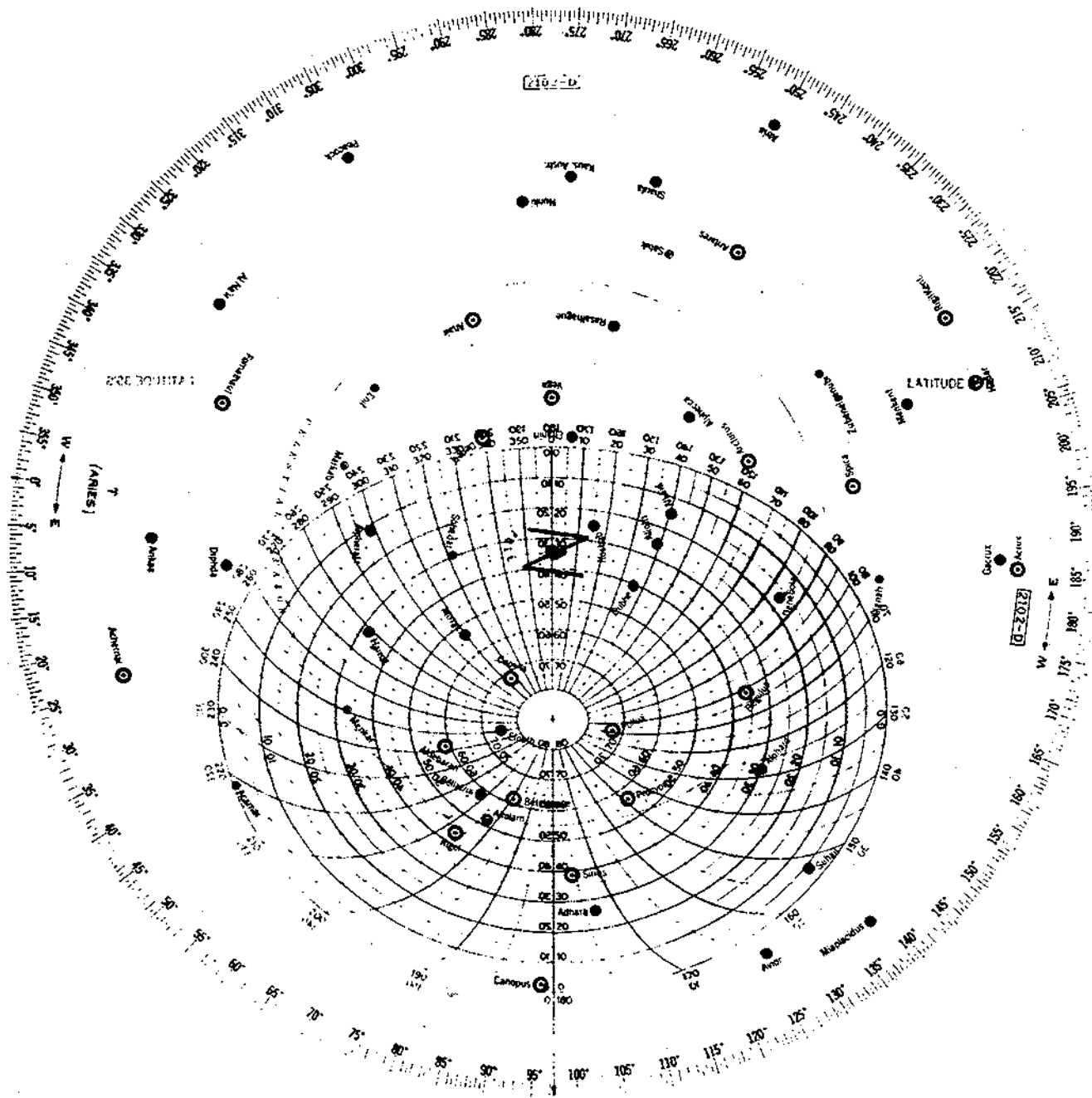

Figure 3-12. - Star base with a blue latitude template in place  
 Template is set for LHA  $\gamma$  = 97°0.2.

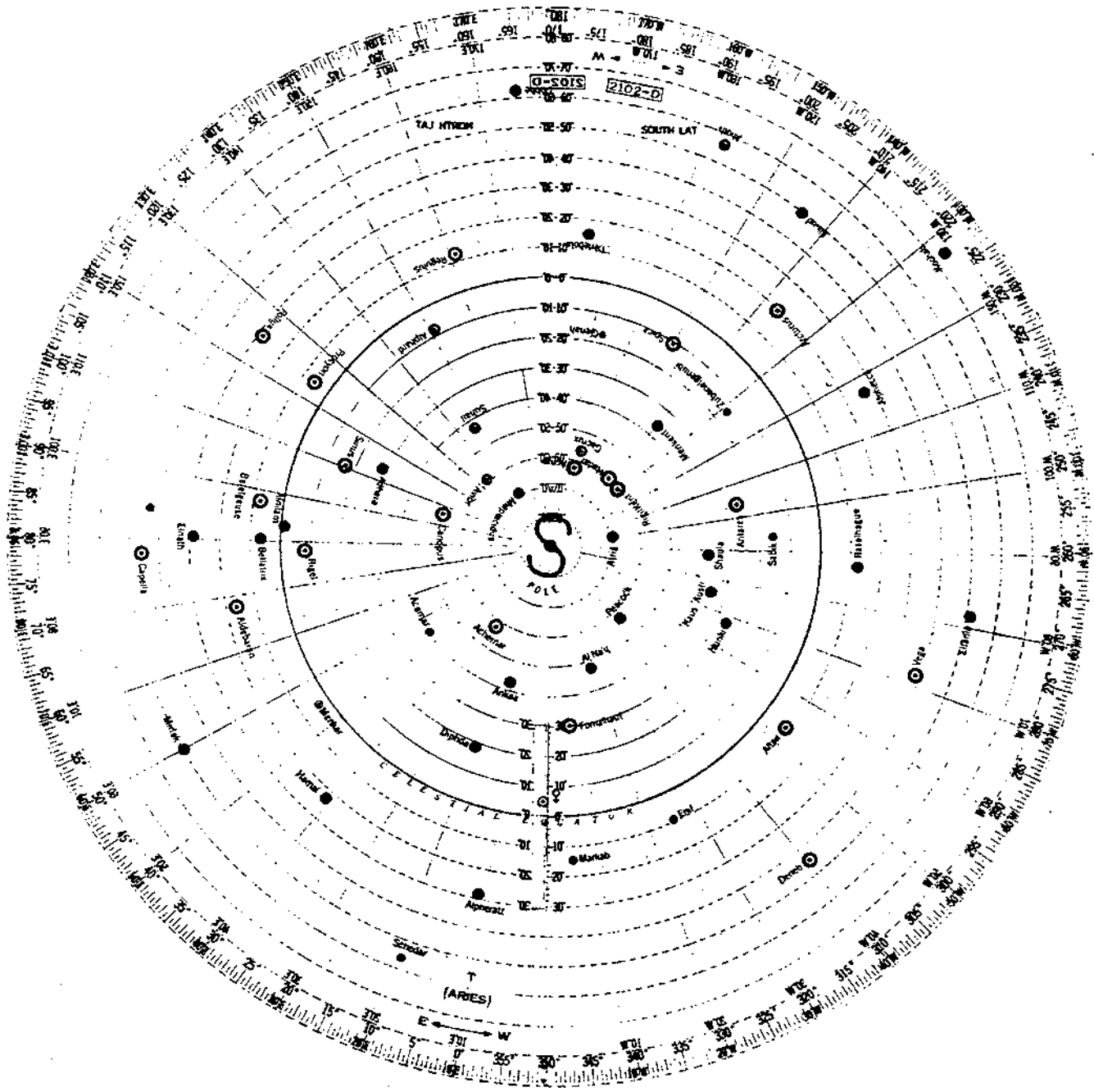

Figure 3-13. - Star base with red declination-meridian angle template in place. Template is set for  $360^{\circ}\text{-SHA} = 350^{\circ}\cdot 8$ , and the planet Venus is plotted at Dec.  $40^{\circ}\cdot 5\text{S}$ .

templates is the same diameter as the star base, and has a small hole at its center which fits over a peg at the center of the star base. The star base and all of the templates are reversible (one side being for north latitude, and the other side being for south latitude), and successful use of this device depends upon properly oriented templates. To do this, select the side of the base plate, and the template, corresponding to the latitude of the observer. Thus, an observer in latitude  $35^{\circ}$  N uses the side of the star base with the letter "N" at the center, and orients the templates so that the inscription LATITUDE  $35^{\circ}$ N is uppermost, or readable, on the blue template when it is used, and the inscription NORTH LAT. is uppermost, or readable, on the red template when it is used. If the observer is in Lat.  $35^{\circ}$ S, the star base and each template would be turned over, so that the letter "S" could be seen at the center of the star base and the inscriptions LATITUDE  $35^{\circ}$ S and SOUTH LAT. were uppermost, or readable, on the templates. The star finder shown in figure 3-12 is oriented for use in north latitude, and the one in figure 3-13 is oriented for use in south latitude. Since the templates are transparent, the numbers and letters for use in north latitude can be seen reversed when you use the template in south latitude, and vice versa.

### IDENTIFYING THE "DAILY-PAGE STARS"

The most common use of the star finder is for determining the approximate altitudes and azimuths of celestial bodies which will be favorably located for observation during twilight, so that you may locate and observe them at that time with a minimum of delay.

In using the device for this purpose, the navigator first determines LHA $\gamma$  at the approximate mid-time of the period during which observations will be made. The time of the beginning of civil twilight (for morning observations) or of its ending (for evening observations) will yield the most accurate results. However, the navigator can use values for a time more conveniently used in entering the almanac (such as the nearest whole hour of GMT) for rough approximations. Then, the LHA of Aries is determined for this time and the blue template is selected for the latitude closest to the DR position and placed on the star

base, making sure that the correct side is up. Next, the arrow is aligned which extends from the  $0^{\circ}$  -  $180^{\circ}$  azimuth line with the graduation along the circumference of the star base which corresponds to the computed LHA $\gamma$ . Finally, the navigator notes the approximate altitudes and azimuths of the stars to observe during twilight. The altitude of a body is indicated by the concentric, closed curves, altitude  $0^{\circ}$  represented by the outermost curve, and altitude  $90^{\circ}$  represented by the small cross at the center. The azimuth of a body is indicated by the curved lines radiating from the center, azimuth increasing in a clockwise direction.

Example: A navigator whose DR position at the time of the ending of civil twilight will be Lat.  $37^{\circ}14'.8$  N, Long.  $144^{\circ}25'.6$  E, determines the GHA of Aries to be  $312^{\circ}46'.8$  at that time.

Find: The approximate altitude (ha) and azimuth of all first magnitude stars which will be above the horizon at that time.

Solution: First, determine LHA $\gamma$  in the usual manner. In this case, it is  $97^{\circ}12'.4$ , select the blue latitude template closest to the DR latitude and place it over the star base so that the labels on each correspond to the name of the DR latitude. In this case we select the template for LATITUDE  $35^{\circ}$ N and place it over the side of the star base which has the letter "N" at the center, as shown in figure 3-12. Orient the template so that the arrow extending from the  $0^{\circ}$  -  $180^{\circ}$  azimuth line points to the value on the base plate of LHA $\gamma$  for the time desired. In this case the arrow is aligned, approximately, with  $97^{\circ}.2$  (figure 3-12). Finally, note the approximate altitudes and azimuths of the desired celestial bodies. The approximate altitudes and azimuths of the first magnitude stars are tabulated on the next page, in order of increasing azimuth.

The number of first magnitude stars observable at this time is greater than average. In all probability the navigator would ignore Pollux, Canopus, and Capella when making observations, because of their extreme altitudes and the resulting increased probability of error in lines of position obtained from these bodies.

Body	ha	Zn
Regulus	36°	101°
Pollux	73°	116°
Procyon	57°	148°
Sirius	39°	176°
Canopus	2°	181°
Betelgeuse	62°	200°
Rigel	43°	207°
Aldebaran	58°	243°
Capella	72°	315°

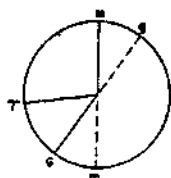

GHAT 312°46'.8  
 λ 144°25'.6 E  
 LHAT 97°12'.4

### IDENTIFYING OTHER KNOWN CELESTIAL BODIES

You may use the star finder to identify other known celestial bodies if you plot their positions on the star base. This usually is done only for the planets, but you may also plot additional stars from among those tabulated near the back of the Nautical Almanac, if there is need for them. You may also plot the positions of the sun and moon, if desired.

In using the device for locating a planet, the navigator first determines 360°-SHA of the planet for the approximate mid-time of the period during which he will use the information, and the approximate declination of the body at that time. The positions of the planets are not printed on the star base because they change relative to the stars; but the change is not a rapid one and ordinarily you can ignore it over a period of several days. Thus, if a vessel is departing on a 2-week voyage, you could plot the positions of the planets on the star base using their SHA's and declinations for a date approximately 1 week after departure. The SHA of each navigational planet is tabulated on the left-hand daily pages of the Nautical Almanac, at the foot of the column of star data. The navigator then places the red template on the star base, making sure that the side for the correct latitude is up. Next the navigator orients the arrow which marks 0° on the template with the degree-marking

along the circumference of the star base which most nearly corresponds to 360°-SHA. Finally, the position of the planet plotted through the open slot in the red template. This slot has declination markings along one side, from 30° at one end, through 0°, to 30° at the opposite end. The 0° marking indicates the celestial equator, and the declinations from that point toward the center of the star base are of the same name (north or south) as indicated by the letter at the center of the base (N or S); the declinations from 0° toward the circumference of the base plate are of the opposite name. Thus, in figure 3-13 the red template is shown in place on the side of the star base for south latitudes, and the 30° marking closer to the center is for declination 30°S, while the one closer to the circumference is for declination 30°N.

Example: An observer is sailing in the south latitudes during the period 25-27 April 1958. Plot the positions of the navigational planets during this time on the side of the star base which this observer will use.

Solution: First determine 360°-SHA and the approximate declination of each planet for the approximate mid-time of the period for which the information is to be used. In this case these values, taken from the left-hand daily page of the Nautical Almanac for 25-27 April 1958 shown in figure 3-14 are as follows:

PLANET	SHA	360°-SHA	Dec.
Venus	9°10'.9	350°49'.1	4°.5 S
Mars	28°08'.6	331°51'.4	13°.1 S
Jupiter	155°37'.9	204°22'.1	8°.5 S
Saturn	95°01'.0	264°59'.0	21°.9 S

Place the red template over the star base so that the labels of both correspond to the south latitude of the observer. For each planet, orient the template so that the red arrow is aligned with the degree-marking nearest 360°-SHA of that planet, and plot the position of the planet on the declination scale along the slot in the red template. The procedure for Venus is shown in figure 3-13. Since all of the planets have southerly declinations in this example, all of the planets should be plotted from the 0° declination mark toward the center of the star base.



APRIL 25, 26, 27, (FRI., SAT., SUN.)

G.M.T. d h	ARIES			VENUS -38			MARS +09			JUPITER -20			SATURN +05			STARS		
	G.H.A.	G.H.A.	Dec.	G.H.A.	Dec.	G.H.A.	Dec.	G.H.A.	Dec.	G.H.A.	Dec.	Name	S.H.A.	Dec.				
25 00	212 30.2	222 41.7	S 5 00.4	241 21.6	S 13 25.6	8 09.9	S 8 33.1	307 29.0	S 21 56.1	Acamar	315 50.2	S 40 28.4						
01	227 32.6	237 41.7	4 59.6	256 22.3	25.0	23 03.7	33.0	322 31.6	56.1	Achernar	335 58.2	S 57 26.9						
02	242 35.1	252 41.6	58.7	271 23.0	24.3	38 06.5	32.9	337 34.1	56.1	Acrux	173 55.0	S 62 52.3						
03	257 37.6	267 41.5	57.8	286 23.6	23.7	53 09.2	32.7	352 36.7	56.1	Adhara	255 45.2	S 28 55.2						
04	272 40.0	282 41.5	57.0	301 24.3	23.1	68 12.0	32.6	7 39.2	56.1	Aldebaran	291 37.3	N 16 25.5						
05	287 42.5	297 41.4	56.1	316 25.0	22.5	83 14.8	32.5	22 41.8	56.1									
06	302 45.0	312 41.3	S 4 55.3	331 25.7	S 13 21.9	98 17.5	S 8 32.4	37 44.3	S 21 56.1	Alioth	166 56.5	N 56 11.2						
07	317 47.4	327 41.3	54.4	346 26.3	21.3	113 20.3	32.3	52 46.9	56.1	Alkaid	153 31.1	N 49 31.2						
08	332 49.9	342 41.2	53.5	1 27.0	20.7	128 23.0	32.2	67 49.4	56.1	Al Na'ir	28 35.9	S 47 09.6						
09	347 52.4	357 41.2	52.7	16 27.7	20.1	143 25.8	32.1	82 52.0	56.1	Alnilam	276 28.7	S 1 13.9						
10	2 54.8	12 41.1	51.8	31 28.4	19.5	158 28.6	32.0	97 54.6	56.1	Alphard	218 36.7	S 8 28.9						
11	17 57.3	27 41.0	50.9	46 29.1	18.9	173 31.3	31.9	112 57.1	56.1									
12	32 59.7	42 41.0	S 4 50.1	61 29.7	S 13 18.3	188 34.1	S 8 31.8	127 59.7	S 21 56.1	Alphecca	126 45.8	N 26 51.2						
13	48 02.2	57 40.9	49.2	76 30.4	17.7	203 36.8	31.6	143 02.2	56.1	Alpheratz	358 26.7	N 28 51.5						
14	63 04.7	72 40.8	48.3	91 31.1	17.1	218 39.6	31.5	158 04.8	56.1	Altair	62 48.6	N 8 45.4						
15	78 07.1	87 40.8	47.5	106 31.8	16.4	233 42.4	31.4	173 07.3	56.1	Ankaa	353 57.0	S 42 31.9						
16	93 09.6	102 40.7	46.6	121 32.5	15.8	248 45.1	31.3	188 09.9	56.1	Antares	113 15.8	S 26 20.4						
17	108 12.1	117 40.6	45.7	136 33.1	15.2	263 47.9	31.2	203 12.4	56.1									
18	123 14.5	132 40.6	S 4 44.9	151 33.8	S 13 14.6	278 50.6	S 8 31.1	218 15.0	S 21 56.1	Arcturus	146 33.2	N 19 23.8						
19	138 17.0	147 40.5	44.0	166 34.5	14.0	293 53.4	31.0	233 17.5	56.1	Atria	108 55.4	S 68 57.0						
20	153 19.5	162 40.4	43.1	181 35.2	13.4	308 56.2	30.9	248 20.1	56.0	Avior	234 35.0	S 59 22.9						
21	168 21.9	177 40.4	42.3	196 35.9	12.8	323 58.9	30.8	263 22.6	56.0	Bellatrix	279 16.7	N 6 18.6						
22	183 24.4	192 40.3	41.4	211 36.5	12.2	339 01.7	30.6	278 25.2	56.0	Betelgeuse	271 46.4	N 7 23.9						
23	198 26.9	207 40.2	40.5	226 37.2	11.6	354 04.4	30.5	293 27.7	56.0									
26 00	213 29.3	222 40.2	S 4 39.6	241 37.9	S 13 11.0	9 07.2	S 8 30.4	308 30.3	S 21 56.0	Canopus	264 14.8	S 52 40.7						
01	228 31.8	237 40.1	38.8	256 38.6	10.4	24 10.0	30.3	323 32.9	56.0	Capella	281 36.1	N 45 57.4						
02	243 34.2	252 40.0	37.9	271 39.3	9.7	39 12.7	30.2	338 35.4	56.0	Deneb	49 59.7	N 45 07.7						
03	258 36.7	267 40.0	37.0	286 39.9	9.1	54 15.5	30.1	353 38.0	56.0	Denebola	183 15.6	N 14 48.2						
04	273 39.2	282 39.9	36.1	301 40.6	8.5	69 18.2	30.0	8 40.5	56.0	Diphda	349 37.8	S 18 12.9						
05	288 41.6	297 39.8	35.3	316 41.3	7.9	84 21.0	29.9	23 43.1	56.0									
06	303 44.1	312 39.8	S 4 34.4	331 42.0	S 13 07.3	99 23.8	S 8 29.8	38 45.6	S 21 56.0	Dubhe	194 42.1	N 61 58.7						
07	318 46.6	327 39.7	33.5	346 42.7	6.7	114 26.5	29.7	53 48.2	56.0	Elnath	279 05.3	N 28 34.3						
08	333 49.0	342 39.6	32.6	1 43.3	6.1	129 29.3	29.6	68 50.7	56.0	Elnarin	91 05.1	N 51 29.4						
09	348 51.5	357 39.6	31.8	16 44.0	5.5	144 32.0	29.4	83 53.3	56.0	Enif	34 27.9	N 9 40.9						
10	3 54.0	12 39.5	30.9	31 44.7	4.9	159 34.8	29.3	98 55.9	56.0	Fomalhaut	16 09.9	S 29 50.5						
11	18 56.4	27 39.4	30.0	46 45.4	4.2	174 37.5	29.2	113 58.4	56.0									
12	33 58.9	42 39.4	S 4 29.1	61 46.1	S 13 03.6	189 40.3	S 8 29.1	129 01.0	S 21 56.0	Gacrux	172 46.6	S 56 53.0						
13	49 01.3	57 39.3	28.3	76 46.8	0.9	204 43.1	29.0	144 03.5	56.0	Gienah	176 34.7	S 17 18.8						
14	64 03.8	72 39.2	27.4	91 47.4	0.2	219 45.8	28.9	159 06.1	56.0	Hadar	149 46.1	S 60 10.4						
15	79 06.3	87 39.2	26.5	106 48.1	0.8	234 48.6	28.8	174 08.6	55.9	Hamal	328 47.9	N 23 15.8						
16	94 08.7	102 39.1	25.6	121 48.8	0.2	249 51.3	28.7	189 11.2	55.9	Kaus Aust.	84 38.6	S 34 24.2						
17	109 11.2	117 39.0	24.7	136 49.5	13 00.6	264 54.1	28.6	204 13.7	55.9									
18	124 13.7	132 39.0	S 4 23.9	151 50.2	S 12 59.9	279 56.9	S 8 28.5	219 16.3	S 21 55.9	Kochab	137 17.1	N 74 19.5						
19	139 16.1	147 38.9	23.0	166 50.9	59.3	294 59.6	28.3	234 18.9	55.9	Markab	14 19.8	N 14 58.8						
20	154 18.6	162 38.8	22.1	181 51.5	58.7	310 02.4	28.2	249 21.4	55.9	Menkar	314 58.7	N 3 55.5						
21	169 21.1	177 38.7	21.2	196 52.2	58.1	325 05.1	28.1	264 24.0	55.9	Menkent	148 56.1	S 36 10.0						
22	184 23.5	192 38.7	20.3	211 52.9	57.5	340 07.9	28.0	279 26.5	55.9	Miaplacidus	221 48.3	S 69 33.2						
23	199 26.0	207 38.6	19.4	226 53.6	56.9	355 10.6	27.9	294 29.1	55.9									
27 00	214 28.5	222 38.5	S 4 18.6	241 54.3	S 12 56.3	10 13.4	S 8 27.8	309 31.6	S 21 55.9	Mirfak	309 40.2	N 49 42.8						
01	229 30.9	237 38.5	17.7	256 55.0	55.6	25 16.2	27.7	324 34.2	55.9	Nunki	76 49.5	S 26 20.8						
02	244 33.4	252 38.4	16.8	271 55.6	55.0	40 18.9	27.6	339 36.8	55.9	Peacock	54 24.5	S 56 51.9						
03	259 35.8	267 38.3	15.9	286 56.3	54.4	55 21.7	27.5	354 39.3	55.9	Pollux	244 18.5	N 28 07.6						
04	274 38.3	282 38.3	15.0	301 57.0	53.8	70 24.4	27.4	9 41.9	55.9	Procyon	245 43.2	N 5 19.8						
05	289 40.8	297 38.2	14.1	316 57.7	53.2	85 27.2	27.3	24 44.4	55.9									
06	304 43.2	312 38.1	S 4 13.3	331 58.4	S 12 52.6	100 30.0	S 8 27.1	39 47.0	S 21 55.9	Rasalhague	96 44.7	N 12 35.3						
07	319 45.7	327 38.0	12.4	346 59.1	52.0	115 32.7	27.0	54 49.6	55.9	Regulus	208 27.5	N 12 10.1						
08	334 48.2	342 38.0	11.5	1 59.7	51.3	130 35.5	26.9	69 52.1	55.9	Rigel	281 52.1	S 8 15.2						
09	349 50.6	357 37.9	10.6	17 00.4	50.7	145 38.2	26.8	84 54.7	55.9	Rigel Kent.	140 47.7	S 60 39.9						
10	4 53.1	12 37.8	9.7	32 01.1	50.1	160 41.0	26.7	99 57.2	55.9	Sabik	102 59.8	S 15 40.4						
11	19 55.6	27 37.7	8.8	47 01.8	49.5	175 43.7	26.6	114 59.8	55.9									
12	34 58.0	42 37.7	S 4 07.9	62 02.5	S 12 48.9	190 46.5	S 8 26.5	130 02.4	S 21 55.8	Schedar	350 28.3	N 56 18.4						
13	50 00.5	57 37.6	07.0	77 03.2	48.3	205 49.3	26.4	145 04.9	55.8	Shaula	97 17.9	S 37 04.3						
14	65 03.0	72 37.5	06.2	92 03.9	47.6	220 52.0	26.3	160 07.5	55.8	Sirius	259 10.4	S 16 39.8						
15	80 05.4	87 37.5	05.3	107 04.6	47.0	235 54.8	26.2	175 10.0	55.8	Spica	159 14.6	S 10 56.8						
16	95 07.9	102 37.4	04.4	122 05.2	46.4	250 57.5	26.1	190 12.6	55.8	Sohail	223 22.9	S 43 16.2						
17	110 10.3	117 37.3	03.5	137 05.9	45.6	266 00.3	26.0	205 15.2	55.8									
18	125 12.8	132 37.2	S 4 02.6	152 06.6	S 12 45.2	281 03.0	S 8 25.8	220 17.7	S 21 55.8	Vega	81 06.8	N 38 44.5						
19	140 15.3	147 37.2	01.7	167 07.3	44.5	296 05.8	25.7	235 20.3	55.8	Zuben'ubi	137 51.0	S 15 52.2						
20	155 17.7	162 37.1	4 00.8	182 08.0	43.9	311 08.6	25.6	250 22.8	55.8									
21	170 20.2	177 37.0	3 59.9	197 08.7	43.3	326 11.3	25.5	265 25.4	55.8									
22	185 22.7	192 36.9	59.0	212 09.4	42.7	341 14.1	25.4	280 28.0	55.8	Venus	9 10.9	9 09						
23	200 25.1	207 36.9	58.1	227 10.1	42.1	356 16.8	25.3	295 30.5	55.8	Mars	28 08.6	7 53						
										Jupiter	155 37.9	23 19						
										Saturn	95 01.0	3 25						

Figure 3-14. - A left-hand daily page of the Nautical Almanac.

The SHA of the planets is not tabulated in the Air Almanac, but you can obtain it by subtracting the GHA of Aries at a given time from the GHA of the body at the same time, adding  $360^\circ$  to the GHA of the body when necessary. In this way you obtain the value  $360^\circ$ -SHA, and can then plot the position of the planet on the star base as explained above. Thus, if at a given time the GHA of Mars is  $149^\circ 26'$  and GHA $\uparrow$  at the time is  $317^\circ 11'$  the SHA of Mars is  $192^\circ 15'$  (since  $149^\circ 26' - 317^\circ 11' = 509^\circ 26' - 317^\circ 11' = 192^\circ 15'$ ), and  $360^\circ$ -SHA is  $167^\circ 45'$ . This also is the procedure used to determine  $360^\circ$ -SHA for the sun or moon, if you desire to plot either of those bodies, as their SHA's are not tabulated in either almanac. The SHA's of additional stars are tabulated at monthly intervals near the back of the Nautical Almanac, and you may plot them in the manner explained above, although less conveniently if declination exceeds  $30^\circ$ .

#### IDENTIFYING UNKNOWN CELESTIAL BODIES

The navigator may identify an unknown celestial body with the rule by noting its altitude and azimuth at the time of observation, and using either the appropriate blue latitude template, or the latitude template and the red meridian angle-declination template simultaneously.

Having observed the altitude and approximate azimuth of a celestial body and noted the time, the navigator selects the blue template for the latitude closest to the DR position. The template is placed over the appropriate side of the star base so that the blue arrow on the template is aligned with LHA $\uparrow$  for that time. The intersection of the altitude and azimuth curves which correspond to the observed altitude and azimuth is noted. The navigator may usually assume that the body shown on the star base at or quite near that point is the body which was observed. However, if no body appears at or near that point, or if the navigator suspects that the one shown is not the one observed (perhaps because its magnitude does not correspond to the estimate of the one observed), the navigator may use the red template to determine the declination and meridian angle of the body. This is done by placing the red template over the blue one

(making certain that the correct side is up) and aligning the arrow on both templates. Using the point found on the blue template by the intersection of altitude and azimuth curves, the navigator estimates the declination and meridian angle of the body by means of the declination circles and meridian angle lines on the red template. The name of the declination is taken with respect to the letter (N or S) at the center of the star base, and the meridian angle is indicated by the uppermost, or readable, label along the circumference of the red template. Knowing the meridian angle of the body observed and the longitude, the navigator can compute the GHA of the body, and from that the SHA, if necessary. With this information the navigator can inspect the coordinates of the planets tabulated for that time on the daily pages of the almanac (assuming that the planets have not been plotted on the star base) or the coordinates of the additional stars at the back of the Nautical Almanac, to determine which body was observed. If a celestial body cannot be found with these coordinates, the navigator has observed a star for which information is not given in the almanac, or perhaps the planet Mercury. Mercury is not tabulated in the almanacs because it is usually too close to the sun to be seen.

#### STAR IDENTIFICATION BY PUB 229

There are no formal star identification tables in PUB 229. Star identification is possible by scanning the pages of the appropriate latitudes and by observing the combination of arguments that gives the altitude and azimuth angle of the observation. The declination and LHA of the star are determined directly. The star's SHA is found from  $SHA\star = LHA\star - LHA\uparrow$ . From these quantities, the star can be identified from the Nautical Almanac.

Another method of identifying stars is provided through an interchange of arguments using the nearest whole values. You enter the tables with the observer's latitude (same name as declination), with the observed azimuth angle (converted from observed true azimuth as required) as LHA and the observed altitude as declination. Extract the corresponding altitude and azimuth angle from the tables. The extracted

altitude becomes the body's declination, and the extracted azimuth angle (or its supplement) is the meridian angle of the body. The tables are always entered with latitude of the same name as declination. In north latitudes, the tables can be entered with the true azimuth as LHA.

If the corresponding figures are extracted from above the c - s (contrary same) line on

the right-hand page, the name of the latitude is contrary to that of declination. Otherwise, the declination of the body has the same name as the latitude. If the corresponding azimuth angle is extracted from above the c - s line, the supplement of the tabular value is the meridian angle,  $t$ , of the body. If the body is east of the observer's meridian,  $LHA = 360^{\circ} - t$ ; if the body is west of the meridian,  $LHA = t$ .

altitude becomes the body's declination, and the extracted azimuth angle (or its supplement) is the meridian angle of the body. The tables are always entered with latitude of the same name as declination. In north latitudes, the tables can be entered with the true azimuth as LHA.

If the corresponding figures are extracted from above the c - s (contrary same) line on

the right-hand page, the name of the latitude is contrary to that of declination. Otherwise, the declination of the body has the same name as the latitude. If the corresponding azimuth angle is extracted from above the c - s line, the supplement of the tabular value is the meridian angle,  $t$ , of the body. If the body is east of the observer's meridian,  $LHA = 360^{\circ} - t$ ; if the body is west of the meridian,  $LHA = t$ .

### SELF-QUIZ #3

1. While testing the sextant for perpendicularity of the index mirror, the observer notes that the two views DO NOT form a straight line. To correct this, you should adjust the \_\_\_\_\_.
  - A. index mirror
  - B. horizon glass
  - C. tangent screw
  - D. telescope shade
2. If the horizon glass is NOT perpendicular to the frame, the sextant contains \_\_\_\_\_ error.
  - A. index
  - B. collimation
  - C. parallel
  - D. side
3. A small lack of parallelism of the horizon glass and index mirror introduces \_\_\_\_\_.
  - A. refraction
  - B. reflection
  - C. index error
  - D. side error
4. As rays of light from celestial bodies pass through the layers of the atmosphere, a phenomenon known as \_\_\_\_\_ occurs.
  - A. refraction
  - B. parallax
  - C. reflection
  - D. dip
5. To which body must semidiameter corrections be applied?
  - A. Rigel
  - B. Sun
  - C. Mars
  - D. Polaris
6. To utilize the Star finder and identifier with the blue templates, you must know the \_\_\_\_\_.
  - A. SHA of the body
  - B. RA of each star
  - C. GHA of Aries
  - D. LHA of Aries
7. How many templates are included in the star finder case along with the star base?
  - A. 8
  - B. 9
  - C. 10
  - D. 15
8. Star finders are intended to furnish the approximate altitude and \_\_\_\_\_ of celestial bodies.
  - A. zenith
  - B. azimuth
  - C. altimeter
  - D. angle
9. The blue latitude templates are constructed for each \_\_\_\_\_ degrees of latitude.
  - A. 5
  - B. 10
  - C. 15
  - D. 20
10. The numbers on the outside edge of the blue templates of the Star finder indicate the \_\_\_\_\_.
  - A. GHA of Aries
  - B. LHA of Aries
  - C. LHA of the body
  - D. azimuth of the body

### ANSWERS TO SELF-QUIZ #3

QUESTION	ANSWER	REFERENCE
1	A	3-3
2	D	3-3
3	C	3-4
4	A	3-8
5	B	3-9
6	D	3-12
7	C	3-12
8	B	3-12
9	B	3-12
10	D	3-12

## CELESTIAL FIX

Reading Assignment: 4  
Pages 4-1 through 4-7

### OBJECTIVES

To successfully complete this assignment, you must study the text and master the following objectives:

1. Outline the procedure for plotting a celestial fix.
2. Explain how to determine an estimated position based on a single LOP.
3. Outline the procedure for plotting a running fix, using a celestial observation.

### INTRODUCTION

In celestial navigation, lines of position are rarely obtained simultaneously. This is especially true during the day when the sun may be the only available celestial body. A celestial line of position may be advanced for 3 or 4 hours, if necessary, to obtain a celestial running fix. It may also be advanced by advancing the AP in direction and distance an amount consistent with the ship's travel during the interval between two successive observations. In the latter procedure, the azimuth line is drawn through the advanced AP without any change in direction. The advanced LOP is drawn perpendicular to the azimuth, a distance from the AP equal to the intercept, and toward or away from the GP, as appropriate.

### PLOTTING THE CELESTIAL FIX

At morning and evening twilight, the navigator may succeed in observing the altitudes of a number of celestial bodies in a few minutes and thus establish a celestial fix. If 2 or more minutes elapse between observations, the navigator must consider:

- a. elapsed time
- b. speed of ship
- c. scale of the chart or plotting sheet

to determine whether or not a more accurate fix can be obtained by advancing AP's to a

common time. It is possible during the day to obtain a celestial fix rather than a celestial running fix if two or more of the three following bodies are visible:

- a. sun
- b. moon
- c. Venus

### LOP FROM CELESTIAL OBSERVATIONS

You have seen how lines of position, obtained through bearings on terrestrial objects, are used to fix a ship's position in piloting. You know that a ship has many possible locations on a line of positions. In other words, the ship's position must be somewhere along that line. A fix, by definition, is a relatively accurate determination of latitude and longitude. In practice, this position is the intersection of two or more lines of position; but this is not the ship's exact position, because one can always assume some errors in observation, plotting, and the like.

The celestial navigator must establish the lines of position by applying the results of the observations of heavenly bodies. A line of position obtained at one time may be used at a later time. All you need to do is move the line parallel to itself, a distance equal to the run of the ship in the interim, and in the same direction as the run. Such a line of position cannot be as accurate as a new line, because the amount and direction of its movement

can be determined only by the usual DR methods. If two new lines cannot be obtained, however, and old line, advanced and intersected with a new one, may be the only possible way of establishing a fix. Naturally, the distance an old line may be advanced without a substantial loss of accuracy depends on how closely the run can be reckoned.

In celestial navigation, as in piloting, you essentially are trying to establish the intersection of two or more lines of position. A single observation is insufficient to obtain a fix, however it can be used with a loran line, etc. to provide a fix.

## TWO CIRCLES

Observation of two bodies at the same time gives the navigator two circles of equal altitude. The circles intersect each other at two points, and, because the ship is somewhere on each one of them, she must be at one or the other points of intersection. In figure 4-1, circles of equal altitude have been determined by observations of the stars Alpherd and Rigel. The navigator of the ship in this example knows that the ship cannot be at the southern point of intersection; consequently, the northern point, illustrated, must be the fix.

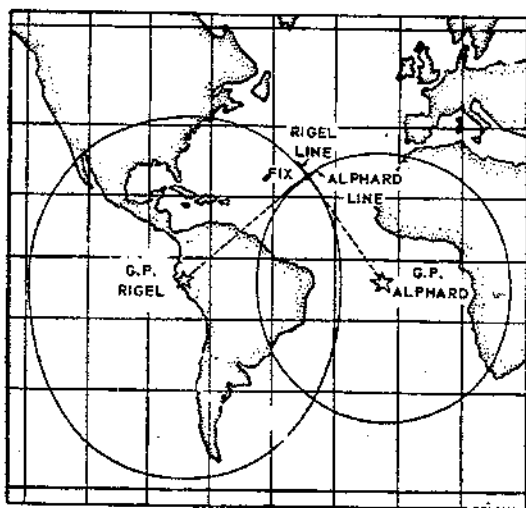

Figure 4-1. - Circles of equal altitude.

## LINE OF POSITION

In practice, you may neither be able nor will you need to plot the whole of a circle of equal altitude. The position is usually known within 10 miles and possibly even less than that. Inside these limits, the curve of the arc of a circle of equal altitude is hardly perceptible, and the arc is plotted and regarded as a straight line. Such a line, comprising enough of the arc of a circle of equal altitude to cover the probable limits of a position, is called a Sumner line of position or just a line of position.

## SINGLE LINE OF POSITION

Although a single line of position cannot establish a fix, it is a locus of possible positions of the ship. In modern celestial navigation, a line of position is determined by first locating an assumed position (AP) on the chart, drawing from it a line along the azimuth of the observed body, and intersecting that line with the LOP. The LOP is always perpendicular to the line of the azimuth. But that LOP is a single line of position, hence you still have to plot another one intersecting it in order to obtain a true fix.

Because the LOP is always at right angles to the line of the azimuth, consequently when an observed body bears due east or west, the line of position coincides with a meridian of longitude. When the body bears due north or south, the line coincides with a parallel of latitude. That is why the sun is always observed at almost noon, when it is on the meridian, to determine the ship's latitude. Also, by observing a celestial body bearing dead ahead or dead astern, the navigator can establish a single line of position that will tell whether the ship has overrun the DR position. Taking observations on an object abeam, the navigator can discover whether the ship is right or left of the course line. By applying the azimuth, latitude, and declination from the azimuth table (described later), the navigator can learn the time at which a given object should arrive on any given bearing.



## TWO LINES OF POSITION

The preferable method of establishing two lines of position is by observing two different bodies, although two lines may be obtained from the same body by observations taken at different times. As in piloting, the nearer the two lines approach a right angle to each other, the more accurate is the fix.

When two lines are determined by observing the same body, the first line established is brought forward the distance run on the course steered. For example, if a ship steams 27 miles on course  $315^\circ$  between the first and second observations, obviously her position is on a line parallel with the first one established, but drawn 27 miles away (to scale) on the course line  $315^\circ$ . Intersection of the line established by the second observation with the advanced line of the first observation is a fix. The fix progressively decreases in accuracy, depending on how far the first line is advanced. You should not advance such a time for more than 5 hours of run.

## DETERMINING A LINE OF POSITION

At this point you might be entitled to complain that much has been said concerning what a line of position tells you, but very little has been said about how you should determine it in the first place. We are coming to that part now.

You probably have grasped the idea that what you want to find out is which circle of equal altitude you are on, and what this altitude is. To draw such a circle, you would need a chart covering an extensive area, unless the heavenly body's altitude approached  $90^\circ$ . Consequently, you do not determine the entire circle but merely a portion of its arc, so small that it is plotted and regarded as a straight line.

Figure 4-2 illustrates the method used in establishing a single line of position by observing a star. An assumed position (AP) is selected according to certain requirements of convenience in calculating (described later). Observation of a star provides sextant altitude. Sextant altitude is then corrected to obtain observed altitude ( $h_o$ ). The star's altitude from the assumed position (called

the computed altitude ( $h_c$ )) and its azimuth angle are determined from tables by a procedure you soon will learn. The azimuth angle is then converted to azimuth.

After selecting an AP, draw the azimuth through the AP. Along the azimuth, measure off the altitude intercept (difference between the observed altitude and the computed altitude). At the end of this measurement, draw a perpendicular line, which is the LOP.

You must know whether altitude intercept ( $a$ ) should be measured from AP TOWARD the star or from AP AWAY from the star. (Frequently, the initials for Coast Guard Academy (CGA) are found to be helpful.) If the computed altitude is greater than the observed altitude, altitude intercept ( $a$ ) is measured away from the star. (In other words applying the CGA "memory aid," you have computed, greater, away (CGA).)

Until recently, the computed altitude from the AP was found by a complicated process called the cosine-haversine formula, in which the DR position was always used as the AP. With the development of the present tabulated methods, most of the values necessary to locate the line of position are obtained from tables. To simplify the procedure, you select an AP whose latitude is in whole degrees and whose longitude results in a LHA of whole degrees.

Actual plotting of the line of position is as follows:

1. Plot the AP (the DR latitude and longitude), and obtain the azimuth from tables.
2. Lay off the azimuth line from the AP toward or away from the body, depending on whether the observed altitude is greater or less than the computed altitude.
3. Measure in the proper direction, along the azimuth line, the difference between the observed and the computed altitude in miles and tenths of miles. This distance is called the altitude intercept ( $a$ ).
4. Draw a line at the extremity of altitude intercept ( $a$ ), perpendicular to the

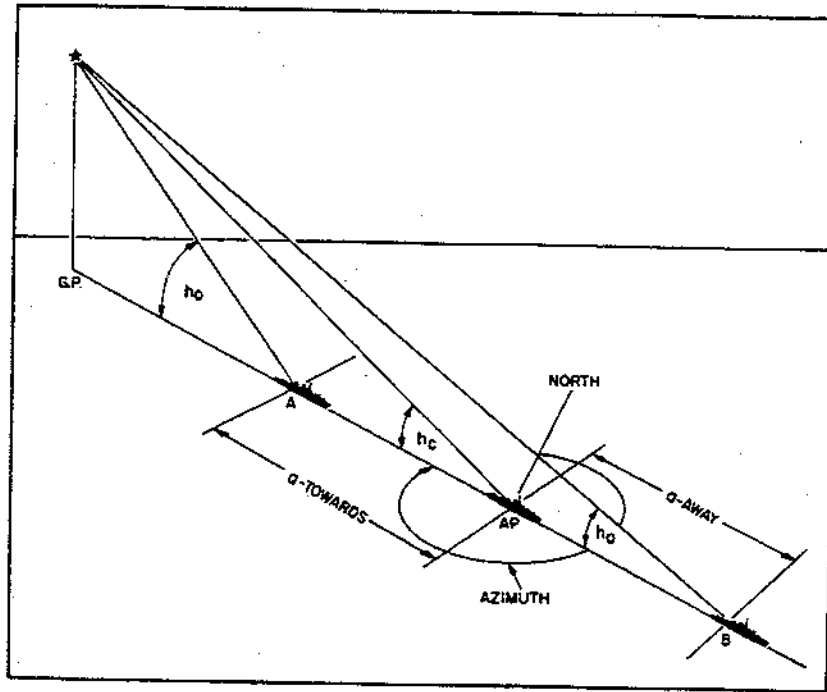

Figure 4-2. - Determining an LOP.

azimuth line. At the time of observation this is a line of position.

5. Label the line of position with the time of observation and the name of the observed body.

### SELECTING BODIES FOR OBSERVATION

Before going further into problems and tables, mention should be made of a few items concerned with selecting astronomical bodies for observation.

Observing two heavenly bodies in rapid succession is the most convenient method of finding two lines of position necessary to establish a fix (figure 4-3). Noting three bodies gives three lines, and these three define the fix more accurately (as in piloting).

Accuracy of the fix established by intersecting lines of position depends upon the angle between the lines. The nearer this angle approaches  $90^{\circ}$ , the more accurate is the fix. In figure 4-4 lines AB and XY intersect at  $90^{\circ}$ . The dotted lines show the effect of a 2-mile error in one or both sights.

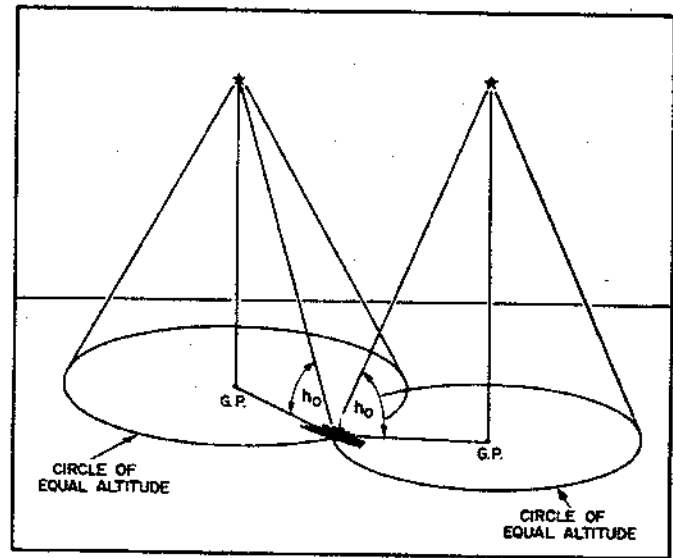

Figure 4-3. - Circles of equal altitude.

If only one line is in error, the position obtained is at the intersection of a full and a dotted line only 2 miles from the true position. If both lines are inaccurate, the maximum error is only about 2.8 miles.

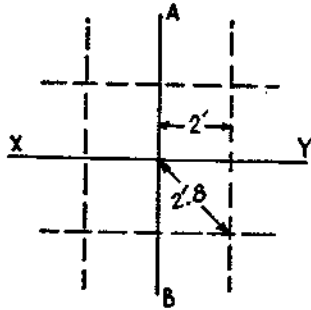

Figure 4-4. - Error at a 90° intersection.

Notice the difference in figure 4-5, where two lines intersect at only 30°. A 2-mile error in one line produces an error of about 4 miles in the fix. Error caused by inaccuracy in both lines may be from 1.6 to 5.6 miles, depending on the direction of the error. Lines intersecting at less than 30° should be avoided whenever possible.

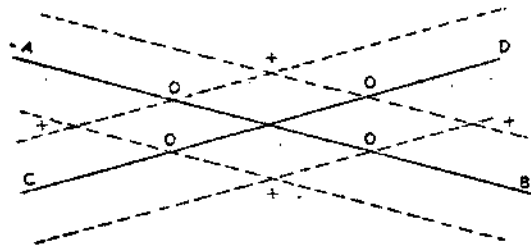

Figure 4-5. - Error at a 30° intersection.

The ideal situation for lines of position established by observing three bodies would be that wherein the bodies lie 120° apart in azimuth. An ideal fix using four bodies would include two north-south lines and two east west lines of position to form a box. As already mentioned, lines perpendicular to the course are frequently valuable for checking the run. Those lines parallel to it are helpful in deciding the accuracy of the course made good.

Concerning altitude, best results are obtained by observation of bodies whose altitudes are between 15° and 65°. In general, observations are taken from bodies whose altitudes are between 10° and 80°.

Actually, sights seldom are taken on two or more bodies simultaneously. Instead, the navigator decides which bodies to observe, then takes a round of sights, each one timed exactly. Resulting lines of position are advanced or retarded the amount of the ship's run between the time of observation and the time of the desired fix.

Figures 4-6 and 4-7 show you a couple of examples of plotting lines of position. Figure 4-8 demonstrates that if the navigator of the ship in figure 4-7 had assumed a different AP, the LOP still would have plotted in the same place, and the azimuth also would have remained practically the same. This knowledge enables navigators to use the same AP for more than one sight, thus reducing the required amount of tabular reference.

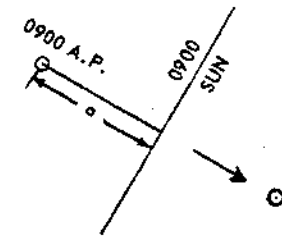

Figure 4-6. - Plotting a sun LOP.

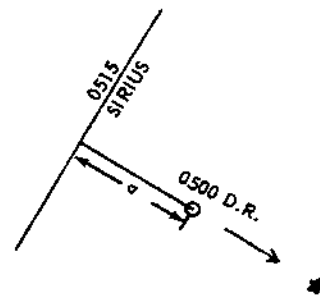

Figure 4-7. - Plotting a star LOP.

In figure 4-9 you see how an 1800 LOP, obtained by observing Venus, was advanced to 1815. Note that the 1800 line was plotted as a dotted line, then was drawn in solid after it was advanced. Also note that the advanced line carries both the time of observation and the later time. This is equivalent to saying: "This line is an 1815 LOP, based on an observation made at 1800." Figure 4-10 shows you how another line of position, obtained by

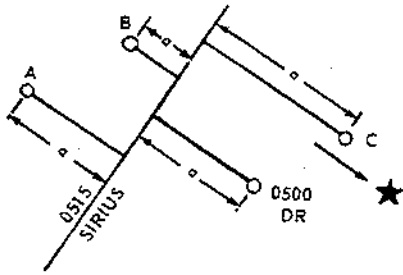

Figure 4-8. - An LOP from several APs.

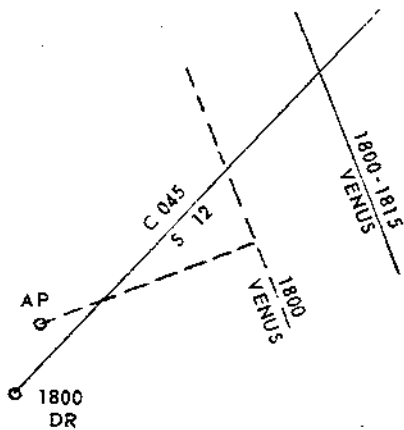

Figure 4-9. - Advancing an LOP.

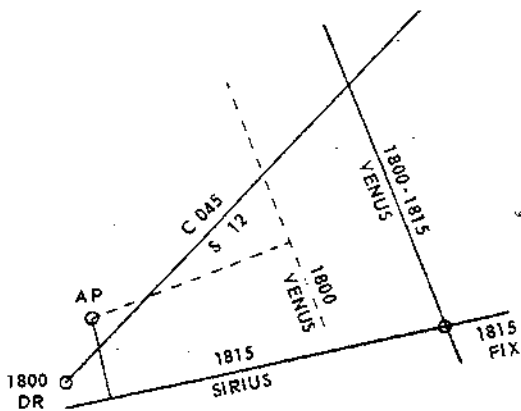

Figure 4-10. - A fix by advancing an LOP.

observation of Sirius at 1815, was intersected with the advanced line to get a fix.

### ADVANCING THE LOP

Several methods may be used to advance a line of position. The most frequent method consists of advancing the AP in the direction of and for the distance of the run, as shown in figure 4-11, and drawing the new LOP.

Figure 4-11 illustrates a situation where the AP was advanced parallel to the course line for the distance run, and a new LOP was plotted from its new position. The new LOP was necessary because the same AP would have produced an LOP that would have intersected the course line beyond the limits of the chart. In this illustrative case, you need not draw the first dotted construction on the chart.

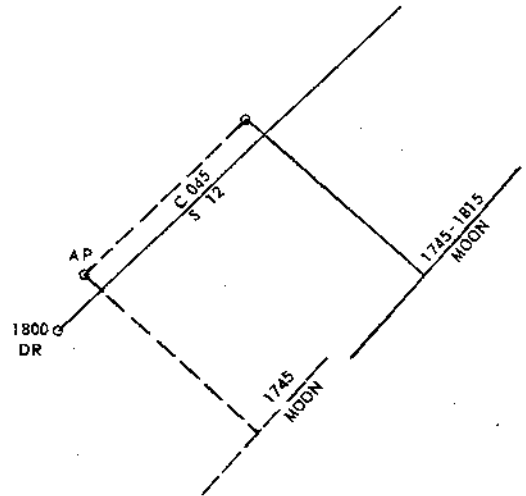

Figure 4-11. - Advancing an LOP parallel.

The manner of advancing lines of position from sights of the moon, Venus, and Sirius (previously illustrated) to obtain an 1815 fix is seen in figure 4-12. Three lines of position by observation like those obtained in piloting, do not always intersect exactly. Quite often a triangle is formed. If one or more of the LOP's have to be advanced, the triangle is likely to be larger. The center of the triangle is assumed to be the fix. (See figures 4-12 and 4-13.) In figure 4-12, note that the plots are made from three separate

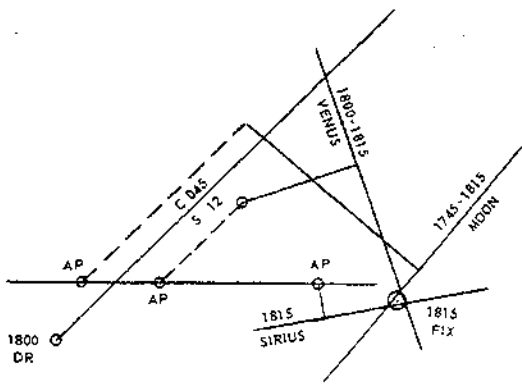

Figure 4-12 - A fix from several LOP's.

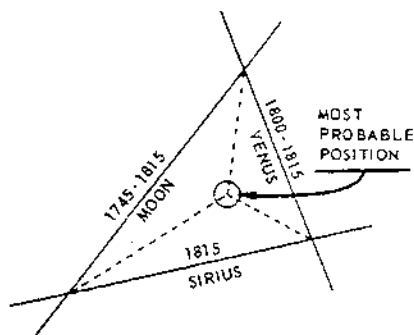

Figure 4-13. - Enlargement of plot of 1815 fix.

AP's, using the same assumed latitude but different assumed longitudes.

### ESTIMATED POSITION BY CELESTIAL NAVIGATION

If appreciable time has elapsed since the determination of the last fix of the ship's position at sea, the error in the DR plot may change where the ship's actual position is well away from her DR plot. A single line of position can be useful in establishing an estimated position. If an accurate line is obtained, the actual position is somewhere on this line. In the absence of better information, a perpendicular from the previous DR position or EP to the line of position establishes the new EP. (See figure 4-14.) The foot of the perpendicular from the AP has no significance in this regard, since it is used only to locate the line of position.

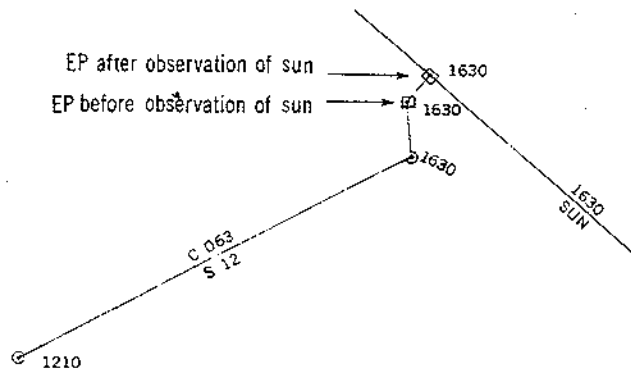

Figure 4-14. - Estimated position before and after observation of the sun for a line of position, allowing for current

The establishment of a good EP is dependent upon accurate interpretation of all information available. Generally, such ability can be acquired only by experience. If, in the judgment of the navigator, the course has been made good, but the speed has been uncertain, the best estimate of the position might be at the intersection of the course line and the LOP. (See figure 4-15.) If the speed since the last fix is considered accurate, but the course is considered uncertain, the EP might be at the intersection of the line of position and an arc centered on the previous fix and of radius equal to distance traveled. (See figure 4-16.)

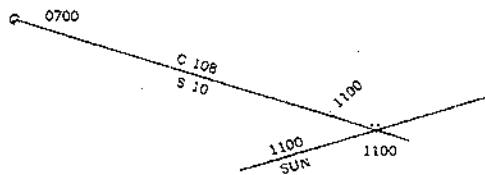

Figure 4-15. - Estimated positions when the course and a line of position are considered accurate.

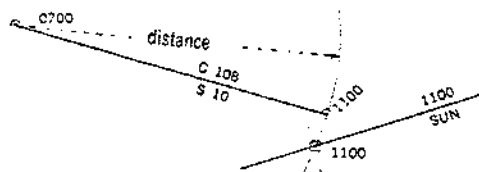

Figure 4-16. - An estimated position when the speed and a line of position are considered accurate.

### SELF-QUIZ #4

1. At the time of an observation, the assumed position is NORMALLY based on a/an \_\_\_\_\_ position.
- A. estimated
  - B. dead reckoning
  - C. loran
  - D. actual
2. The celestial LOP is always perpendicular to the line of the \_\_\_\_\_.
- A. position
  - B. angle
  - C. azimuth
  - D. declination
3. Best results are obtained by observing celestial bodies whose altitudes are between 15 and \_\_\_\_\_ degrees.
- A. 50
  - B. 55
  - C. 60
  - D. 65
4. Celestial lines of position intersecting at angles less than \_\_\_\_\_ degrees should be avoided.
- A. 20
  - B. 30
  - C. 40
  - D. 50

## ANSWERS TO SELF-QUIZ #4

QUESTION	ANSWER	REFERENCE
1	B	4-3
2	C	4-2
3	D	4-5
4	B	4-5

## TWILIGHT AND OTHER PHENOMENON

Reading Assignment: 5  
Pages 5-1 through 5-9

### OBJECTIVES

To successfully complete this assignment, you must study the text and master the following objectives:

1. Define twilight, sunrise, sunset, moonrise, and moonset.
2. List the steps involved in obtaining twilight, sunrise, sunset, moonrise, and moonset.

### SUNRISE, MOONRISE, AND TWILIGHT

We associate the following phenomena with the apparent motion of the sun and the moon:

**SUNRISE** - The instant the upper limb of the sun appears on the visible horizon;

**MOONRISE** - The instant the upper limb of the moon appears on the visible horizon;

**SUNSET** - The instant the upper limb of the sun disappears beyond the visible horizon;

**MOONSET** - The instant the upper limb of the moon disappears beyond the visible horizon;

**TWILIGHT** - The period of semi-darkness occurring just before sunrise (morning twilight), or just after sunset (evening twilight).

The navigator utilizes morning and evening twilight for star observations because during twilight the darkness makes the stars visible, yet permits sufficient light to define the horizon. Both conditions are necessary if an accurate Hs is to be obtained. There are four stages of twilight, based upon the position of the sun with respect to the horizon. They are:

**ASTRONOMICAL TWILIGHT** - The sun is 18 degrees below the horizon. Too dark for observations.

**NAUTICAL TWILIGHT** - The sun is 12 degrees below the horizon. Favorable for observations. Recorded in Nautical Almanac.

**OBSERVATIONAL TWILIGHT** - The sun is 10 degrees below the horizon. Best for observations.

**CIVIL TWILIGHT** - The sun is 6 degrees below the horizon. Too light for observations. Also recorded in the Nautical Almanac.

### SUNRISE AND SUNSET

It is necessary to know the times of sunrise and sunset because of the responsibility of making both morning and evening colors. When doing buoy work or on a search and rescue case, it is necessary to know how long it will be light. Also, the inport lights or navigation lights are energized at sunset and extinguished at sunrise.

Twilight is of importance because during these periods of time the navigator will be taking sights. You will need to know how to determine the most advantageous time for taking sights.

Basically, all three times depend on the observer's position with respect to latitude, longitude, and the location (east or west) of the nearest standard time meridian.

Again, remember that the times shown for rising and setting of the sun and the moon, and twilight in ALL publications are



standard times. If that zone is keeping Daylight Savings Time (DST) it must be accounted for after the final time is figured.

With the given information in the following problem, determine the time of sunrise.

### PROBLEM

Your ship is in position  $36^{\circ} 57'$  North latitude and  $76^{\circ} 20'$  West longitude, and the date is 10 April 1977. The ship will remain in this position all night, and you are required to determine the time of sunrise for 11 April.

Now the question arises, where to look for such information? The answer is, you may find it in at least three places. The Nautical Almanac, the Air Almanac, or you may use the Sunrise-Sunset table (Table 4) in the back of the Tide Tables. The Nautical Almanac will be used throughout this lesson.

All three of these systems are closely aligned in method of determination. The information is listed in tabular form in columns and unless the position being determined for is on one of the parallels listed and on one of the standard time meridians, interpolation must be carried out before the exact time desired may be obtained.

Sunrise and sunset are computed in these tables as follows: The American Nautical Almanac computes SR and SS once for three days for each  $10^{\circ}$  of latitude from the equator to  $30^{\circ}$  North and South. Then each five degrees to  $50^{\circ}$  North and South. Thereafter, each  $2^{\circ}$  of latitude to  $60^{\circ}$  South and to  $72^{\circ}$  North. Information for computing sunrise, sunset, morning and evening twilight is located on the daily pages of the Nautical Almanac.

The Air Almanac lists the times in the same manner as the Nautical Almanac. Information for computing these times is located in the appendix of the Air Almanac.

Table 4, of the Tide Tables, lists the times, for each five days, for each five degrees of latitude from  $0^{\circ}$  to  $30^{\circ}$ , then each  $2^{\circ}$  of latitude to include  $60^{\circ}$  South latitude and  $76^{\circ}$  North latitude.

All times are computed to coincide with each of the Standard Time Meridians. This is possible because each time zone is one hour behind the zone to the east of it. Thus, if sunrise for a given latitude is 0502 on a particular date, it will be in a theoretical visible position (discounting weather and natural barriers such as mountains, etc.) at each local standard time.

LOCAL CIVIL TIME is the STANDARD TIME of meridians, known as STANDARD MERIDIANS. These meridians are located at 1 hour or  $15^{\circ}$  of longitude apart. Commencing with the meridian at Greenwich, each 15th meridian, whether measured East or West, through the 180th meridian, is considered as a STANDARD MERIDIAN.

Where the observer is west of one standard meridian and east of another, the observer will be required to determine from the amount of longitude east or west of a standard meridian, the amount of time later or earlier, that the sun will rise or set.

At the same time, the observer must determine from the latitude the difference of time between parallels listed, and must determine from this the time of sunrise or sunset for the latitude. This is done by INTERPOLATION.

### INTERPOLATION

Before we go too far, what is meant by INTERPOLATION? The navigation dictionary defines interpolation as "the process of determining intermediate values in accordance with some known or assumed rate or system of change." You should be able to comprehend the calculations involved in the process of interpolation. Several methods of interpolation exist, and you should pick the one which is easier for you to understand.

### PROBLEMS IN INTERPOLATION

#### SUNRISE

Now that you know a little more about interpolation, let's try applying it to the problem of finding the time of sunrise on 11 April 1977, for your vessel in position  $36^{\circ} 57'$  N,  $76^{\circ} 20'$  W. The accompanying excerpt

Lat.	Twilight		Sunrise
	Naut.	Civil	
	h m	h m	h m
N 72	////	02 34	04 03
N 70	////	03 01	04 16
68	01 35	03 22	04 27
66	02 12	03 38	04 36
64	02 38	03 51	04 44
62	02 57	04 02	04 50
60	03 13	04 11	04 56
N 58	03 25	04 19	05 01
56	03 36	04 26	05 05
54	03 46	04 32	05 09
52	03 54	04 37	05 13
50	04 01	04 42	05 16
45	04 16	04 53	05 23
N 40	04 28	05 01	05 29
35	04 37	05 08	05 34
30	04 45	05 14	05 38
20	04 57	05 23	05 45
N 10	05 06	05 31	05 52
0	05 13	05 37	05 58
S 10	05 18	05 42	06 04
20	05 22	05 47	06 10
30	05 25	05 52	06 16
35	05 26	05 55	06 20
40	05 26	05 58	06 25
45	05 26	06 00	06 30
S 50	05 26	06 03	06 36
52	05 25	06 04	06 39
54	05 25	06 06	06 42
56	05 24	06 07	06 45
58	05 23	06 09	06 49
S 60	05 22	06 11	06 53

from the Nautical Almanac shows the sunrise column for 9, 10 and 11 April 1977.

Step 1. By inspection you see that your latitude is between 35°N and 40°N and that you must interpolate between 0534 (for 35°N) and 0529 (for 40°N). Lay these figures out as follows:

40°	0529
35°	0534
5°	5 minutes

From this we can determine how much change in time occurs for a change of 1° of latitude by:

5°	1 minute change for 1 degree
	5m

Next, list your latitude and the latitude give in the almanac which is nearest to yours:

36° 57'	your latitude
35°	almanac latitude nearest

yours

1° 57' difference of latitude

1° 57' is almost 2° so round it off to that figure. Now you have.

2° X 1 minute = 2 minutes change in time of sunrise

apply this amount to the time listed for 35° N:

0534	time of sunrise at 35° N
-02	correction for 36° 57' N
0532	time of sunrise at latitude 36° 57' N on any standard meridian.

Now compare this time with those listed in the Almanac:

40° N	0529
36° 57' N	<u>0532</u>
35° N	0534

The problem is NOT complete at this point unless the vessel is located on one of the standard meridians (45°, 60°, 75° etc.) Such is not your case, so let's continue.

Figure 5-1. - Sunrise Table.

**STEP 2.**

Ship's longitude      76°20'W  
 Standard meridian    75°00'W  
 Difference in longitude 1°20'

Your longitude is 76° 20' W, which is 1° 20' west of the 75° W meridian, the standard meridian for your zone. The 1° 20' converted to time will equal 5 minutes 20 seconds. When seconds appear in your computations, round-off the seconds to the nearest minute. Therefore, 5 minutes 20 seconds = 5 minutes. Since you are 5 minutes west of the standard meridian, the time of sunrise will be 5 minutes later at your locality:

Sunrise, latitude 36°57'N      0532  
 Correction for longitude      +5  
 Sunrise, latitude 36°57'N,  
 longitude 76°20'W              0537

**SUNSET**

The sunset tables are made up in the same form as sunrise tables. The upper table being used for sunrise and the lower table for sunset. Determine time of sunset for 11 April 1977 from the 9, 10, and 11 April Nautical Almanac excerpts. The position is 36° 57' N, 76° 20' W. Round off the latitude to 37° N.

**INTERPOLATING FOR LATITUDE**

Sunset, latitude 40° N      1834  
 Sunset, latitude 35° N      1829  
    5°              5 min

Sunset, latitude 37°N      1829  
 Difference for 2°              +2  
 Sunset, latitude 37°N      1831

The longitude correction remains the same as for the sunrise problem because the position is the same; therefore-

Sunset, latitude 37° N      1831  
 Correction for longitude      +5  
 Sunset, latitude 37° N,  
 longitude 76°20'W              1836

Notice, that in this example, the time of sunset is later the farther north you go. Therefore, you add the 2 minutes time difference between 35° N and 37° N.

Lat.	Sunset	Twilight	
		Civil	Naut.
°	h m	h m	h m
N 72	20 03	21 35	////
N 70	19 49	21 05	////
68	19 37	20 44	22 36
66	19 28	20 27	21 55
64	19 20	20 14	21 28
62	19 14	20 03	21 08
60	19 08	19 53	20 52
N 58	19 03	19 45	20 39
56	18 58	19 38	20 28
54	18 54	19 32	20 18
52	18 51	19 26	20 10
50	18 47	19 21	20 02
45	18 40	19 10	19 47
N 40	18 34	19 02	19 35
35	18 29	18 55	19 26
30	18 25	18 49	19 18
20	18 17	18 39	19 06
N 10	18 10	18 32	18 56
0	18 04	18 25	18 50
S 10	17 58	18 20	18 44
20	17 52	18 14	18 40
30	17 45	18 09	18 37
35	17 41	18 07	18 36
40	17 37	18 04	18 35
45	17 32	18 01	18 35
S 50	17 25	17 58	18 35
52	17 23	17 57	18 36
54	17 20	17 55	18 36
56	17 16	17 54	18 37
58	17 12	17 52	18 37
S 60	17 08	17 50	18 38

Figure 5-2. - Sunset table.

For practical everyday usage, you need not attempt to compute the time of sunrise and sunset more exactly than to the nearest minute of time.

### TWILIGHT

Twilight is that period before sunrise when darkness is giving way to daylight, and that period after sunset when daylight is giving way to darkness. In celestial navigation, morning and evening twilight are usually the most important periods of the day. Ordinarily, these are the only times during which you can fix your position by obtaining nearly simultaneous lines of position from celestial observations. At nautical twilight, the sun is  $12^\circ$  below the celestial horizon. At the darker period of civil twilight, the center of the sun is  $6^\circ$  below the celestial horizon, and during good weather, bright stars are easily distinguished, and the horizon is sharp and clear. This is approximately the mid time of the period during which the experienced navigator makes twilight observations. In order for the navigator's eyes to adjust to the darkness, the navigator usually wants to get on the bridge 20 or 30 minutes prior to civil twilight. The Nautical Almanac lists data for obtaining nautical twilight as well as civil twilight for three day intervals. The Air Almanac contains information for figuring civil twilight only and also covers three day intervals. Times of twilight are computed in both publications in the same manner as sunrise and sunset.

### TWILIGHT PROBLEM

The date is 28 March 1977. The position is  $28^\circ 31'.2$  N,  $85^\circ 53'.9$  W. Determine the time of morning civil twilight from the Nautical Almanac excerpts:

1. Find the correction for each degree of latitude.

$30^\circ$  0522  
 $20^\circ$  0536  
 $10^\circ$  4 minutes

$10^\circ$   $\overline{.4 \text{ minute correction}}$   
 $4.0$   
 $4.0$

Lat.	Twilight		Sunrise
	Naut.	Civil	
$^\circ$	h m	h m	h m
N 72	02 30	04 12	05 23
N 70	02 58	04 24	05 27
68	03 19	04 34	05 31
66	03 35	04 42	05 34
64	03 48	04 48	05 37
62	03 58	04 54	05 39
60	04 07	04 59	05 41
N 58	04 15	05 03	05 43
56	04 22	05 07	05 44
54	04 27	05 10	05 46
52	04 32	05 13	05 47
50	04 37	05 16	05 48
45	04 46	05 21	05 51
N 40	04 54	05 25	05 53
35	04 59	05 29	05 54
30	05 04	05 32	05 56
20	05 10	05 36	05 58
N 10	05 15	05 39	06 00
0	05 17	05 41	06 02

Figure 5-3 Twilight Table.

2. Find latitude correction for  $28^\circ 31'.2$  N.

$$\begin{array}{r}
 30^\circ 00'.0 \\
 \underline{28^\circ 31'.2} \\
 1^\circ 28'.8 = 1.5^\circ \text{ (rounded off)}
 \end{array}$$

$$\begin{array}{r}
 1.5^\circ \\
 \underline{\times .4} \\
 .60 \text{ minute correction}
 \end{array}$$

3. Add correction to 0532 as time gets later for lower latitude.

$$\begin{array}{r}
 0532.00 \\
 \underline{+.60} \\
 0532.60 = 0533 \text{ (round off)}
 \end{array}$$

4. Apply correction for longitude.

90° 00'.0	standard meridian
85° 53'.9	observer's meridian
4° 06'.1	longitude difference

5. 1° of arc equals 4 minutes of time so,

4 minutes
X 4° (4° 06'.1 rounded off)
16 minute correction for longitude

6. Longitude correction is subtracted from time because the observer is east of standard meridian.

Twilight for lat. 28° 31'.2 N	0533
Correction for longitude	-16
Time of twilight for position	
28° 31'.2 N, 85° 53'.9 W	0517

### MOONRISE AND MOONSET

Time of rising and setting of the moon is frequently important, especially in wartime when the increase in visibility dictates a ship to start a zigzag and cease blowing tubes. Also, if there is a need to work at night it would be nice to know if there will be moonlight; when it will be light and how long. Times of moonrise and moonset are listed in a section at the back of the Tide Tables for every day in the year for a few selected points. These times can be computed from the Nautical Almanac for any point on the earth. The listed times in the Almanac, however, are LMT of moonrise and moonset at the Greenwich meridian.

#### Finding Time of Moonrise and Moonset

Finding the time of moonrise and moonset is similar to finding the time of sunrise and sunset with one important difference. Since these moon phenomena occur later from one day to the next and at variable rates of change, which are rather large (on the average about 51 minutes a day), there could be a considerable error from using time corrected only for latitude and zone time. The arguments for determining the time of moonrise and moonset are the observer's longitude and the differences in times on the two Greenwich dates (tabulated latitudes) that straddle the local date. For ordinary purposes of

navigation, however, you would be sufficiently accurate to interpolate between consecutive moonrise or moonset at the Greenwich meridian. Since apparent motion of the moon is westward, relative to an observer on the earth, interpolation in west longitude is between the phenomenon on the given date and the following one. In east longitude it is between the phenomenon on the given date and the preceding one.

### NAUTICAL ALMANAC SOLUTION

For the given date, enter the daily-page table for latitude, and extract the LMT for the tabulated latitude next smaller than the observer's latitude, (unless this is an exact tabulated value). Apply a correction from Table I (Figure 5-5) of the Almanac "Tables for Interpolating Sunrise, Moonrise, etc." to interpolate for latitude, determining the sign of correction by inspection. Repeat this procedure for the date following the given date, if in west longitude; or for the day preceding, if east longitude. Using the daily difference between the times for the nearest tabular latitude, and the longitude, enter Table II of the Almanac "Tables for Interpolating Sunrise, Sunset, etc." and take out the correction. Apply this correction to the LMT of moonrise or moonset at the Greenwich meridian on the given date to find the LMT at the position of the observer. The sign to be given the correction is such as to make the corrected time fall between the times for the two dates between which interpolation is being made. This is nearly always positive (+) in west longitude and negative (-) in east longitude. Convert the corrected LMT to ZT.

Example: Find zone time of moonrise at Lat. 47° 10' S, Long. 76° 31' W, on 22 January 1977 using the Nautical Almanac excerpt for 22, 23, and 24 January 1977: (figure 5-4)

47° 10'S	Lat. of observer
45° 00'S	Next tabulated Lat. LESS than
2° 10'	observer's Lat.
2° 10'	difference

Enter Table I (figure 5-5) under 50 Tabular Interval (interval between 45° S and 50° S) going down to 2° 15' (nearest amount of difference between 45° and 47° 10'). Go down from 5m (across top of table) which is

Lat.	Twilight		Sunrise	Moonrise			
	Naut	Civil		22	23	24	25
N 72	07 39	09 18	■	09 30	09 23	09 15	09 08
N 70	07 28	08 53	10 41	09 23	09 21	09 20	09 18
68	07 18	08 33	09 57	09 17	09 20	09 23	09 26
66	07 10	08 17	09 28	09 12	09 19	09 26	09 33
64	07 03	08 04	09 06	09 08	09 19	09 28	09 39
62	06 57	07 53	08 48	09 05	09 18	09 31	09 44
60	06 51	07 44	08 34	09 01	09 17	09 32	09 48
N 58	06 46	07 35	08 21	08 58	09 17	09 34	09 52
56	06 42	07 28	08 11	08 56	09 16	09 36	09 55
54	06 37	07 21	08 01	08 54	09 16	09 37	09 58
52	06 33	07 15	07 53	08 52	09 15	09 38	10 01
50	06 30	07 09	07 45	08 50	09 15	09 39	10 04
45	06 21	06 57	07 29	08 45	09 14	09 42	10 10
N 40	06 14	06 47	07 16	08 42	09 14	09 44	10 14
35	06 07	06 38	07 05	08 39	09 13	09 46	10 18
30	06 00	06 29	06 55	08 36	09 13	09 47	10 22
20	05 47	06 14	06 38	08 32	09 12	09 50	10 28
N 10	05 35	06 00	06 23	08 28	09 11	09 53	10 34
0	05 21	05 46	06 08	08 24	09 10	09 55	10 39
S 10	05 05	05 32	05 54	08 20	09 10	09 58	10 45
20	04 47	05 15	05 38	08 16	09 09	10 00	10 50
30	04 23	04 54	05 21	08 11	09 08	10 03	10 57
35	04 07	04 42	05 10	08 08	09 08	10 05	11 01
40	03 49	04 27	04 58	08 05	09 07	10 07	11 05
45	03 25	04 09	04 44	08 02	09 06	10 09	11 10
S 50	02 52	03 46	04 26	07 58	09 06	10 12	11 16
52	02 35	03 35	04 18	07 56	09 05	10 13	11 19
54	02 13	03 22	04 08	07 53	09 05	10 15	11 22
56	01 44	03 07	03 58	07 51	09 05	10 16	11 25
58	00 54	02 48	03 46	07 48	09 04	10 18	11 29
S 60		02 25	03 32	07 46	09 04	10 20	11 33

Figure 5-4. - Moonrise Table

nearest to time difference between 0802 (Lat. 45°S) and 0758 (Lat. 50° S). Going across from 2° 15' and down from 5m you can see the number 2. This is your Lat. correction. The correction is a MINUS because from Lat. 45° S to 50° S the time of moonrise is going down or is earlier. Apply this correction to the time of the tabulated Lat. that is LOWER than your true Lat.

Lat. 45°S      0802 22 Jan.  
 Lat. Corr. Tab I    -2  
0800 LMT (G) 22 Jan.

This 0800 is the time of moonrise, 22 Jan., local mean time at the GREENWICH meridian (LMT, G) and NOT at your Longitude.

Since you are in WEST Long., you also figure the LMT (G) of moonrise for 23 Jan. You figure this in the same way as you did for moonrise on 22 Jan. above. In this case, you will notice that the times are the same for 45° S (0906) and 50° S (0906) so there is no Lat. correction. You now have the information to enter Table II (bottom of Figure 5-5).

0800 LMT (G) 22 Jan.  
 0906 LMT (G) 23 Jan.  
1h06m difference

Table II (figure 5-5) is entered with the Long. (east or west) of the observer on the left and the difference in times, 1h 06m, of the two dates. 1h 10m is the nearest difference in the top of the table and the correction for 70° Long. is 14M and for 80° Long. is 16m. Since your true Long. is 76° 31', interpolate by eye and use the value in between the two which is 15m. This 15m is normally added for WEST Longitude.

0800 LMT (G) 22 Jan.  
 +15 Tab. II long. correction  
0815 LMT of the observer

In this case you know the Table II (figure 5-5) correction is PLUS because the 0815 LMT result is in between the LMT (G) times of 22 Jan. (0800) and (0906) 23 Jan. This corrected time after using Table II MUST be between the times for the two days or you must reverse the correction sign. If the observer was located at 75° W instead of 76° 31' our problem would be completed since LMT and zone time is the SAME at a standard time meridian. Since our true Long. is 1° 31' west of the standard time meridian (75°W), change this arc, 1° 30' (rounded) to time and add a correction of 6 minutes.

0815 LMT of observer  
 +6 (Long. corr for 1° 30')  
0821 ZT moonrise 22 Jan at your position

Moonset is computed in the same manner as moonrise, and corrections for latitude and longitude are likewise obtained from Table I and Table II. (See figure 5-5.) If the Nautical Almanac which contains Tables I and II are not used and the times for moonrise or moonset are taken from the Nautical/Air Almanac or Tide Tables, a much simpler method may be used: When in east longitude interpolate for latitude on the desired day, and also on the preceding day. In west longitude, interpolate for Lat. on the desired day and the following day. Take the difference between the two results (in minutes), multiply by the Long., divide by 360, and apply the answer to the tabulated time for the specified day. The result will be

## TABLES FOR INTERPOLATING SUNRISE, MOONRISE, ETC.

### TABLE I—FOR LATITUDE

Tabular Interval			Difference between the times for consecutive latitudes															
10°	5°	2°	5 <sup>m</sup>	10 <sup>m</sup>	15 <sup>m</sup>	20 <sup>m</sup>	25 <sup>m</sup>	30 <sup>m</sup>	35 <sup>m</sup>	40 <sup>m</sup>	45 <sup>m</sup>	50 <sup>m</sup>	55 <sup>m</sup>	60 <sup>m</sup>	1 <sup>h</sup> 05 <sup>m</sup>	1 <sup>h</sup> 10 <sup>m</sup>	1 <sup>h</sup> 15 <sup>m</sup>	1 <sup>h</sup> 20 <sup>m</sup>
0 30	0 15	0 06	0	0	1	1	1	1	1	2	2	2	2	2	0 02	0 02	0 02	0 02
1 00	0 30	0 12	0	1	1	2	2	3	3	3	4	4	4	5	05	05	05	05
1 30	0 45	0 18	1	1	2	3	3	4	4	5	5	6	7	7	07	07	07	07
2 00	1 00	0 24	1	2	3	4	5	5	6	7	7	8	9	10	10	10	10	10
2 30	1 15	0 30	1	2	4	5	6	7	8	9	9	10	11	12	12	13	13	13
3 00	1 30	0 36	1	3	4	6	7	8	9	10	11	12	13	14	0 15	0 15	0 16	0 16
3 30	1 45	0 42	2	3	5	7	8	10	11	12	13	14	16	17	18	18	19	19
4 00	2 00	0 48	2	4	6	8	9	11	13	14	15	16	18	19	20	21	22	22
4 30	2 15	0 54	2	4	7	9	11	13	15	16	18	19	21	22	23	24	25	26
5 00	2 30	1 00	2	5	7	10	12	14	16	18	20	22	23	25	26	27	28	29
5 30	2 45	1 06	3	5	8	11	13	16	18	20	22	24	26	28	0 29	0 30	0 31	0 32
6 00	3 00	1 12	3	6	9	12	14	17	20	22	24	26	29	31	32	33	34	36
6 30	3 15	1 18	3	6	10	13	16	19	22	24	26	29	31	34	36	37	38	40
7 00	3 30	1 24	3	7	10	14	17	20	23	26	29	31	34	37	39	41	42	44
7 30	3 45	1 30	4	7	11	15	18	22	25	28	31	34	37	40	43	44	46	48
8 00	4 00	1 36	4	8	12	16	20	23	27	30	34	37	41	44	0 47	0 48	0 51	0 53
8 30	4 15	1 42	4	8	13	17	21	25	29	33	36	40	44	48	0 51	0 53	0 56	0 58
9 00	4 30	1 48	4	9	13	18	22	27	31	35	39	43	47	52	0 55	0 58	1 01	1 04
9 30	4 45	1 54	5	9	14	19	24	28	33	38	42	47	51	56	1 00	1 04	1 08	1 12
10 00	5 00	2 00	5	10	15	20	25	30	35	40	45	50	55	60	1 05	1 10	1 15	1 20

Table I is for interpolating the L.M.T. of sunrise, twilight, moonrise, etc., for latitude. It is to be entered, in the appropriate column on the left, with the difference between true latitude and the nearest tabular latitude which is *less* than the true latitude; and with the argument at the top which is the nearest value of the difference between the times for the tabular latitude and the next higher one; the correction so obtained is applied to the time for the tabular latitude; the sign of the correction can be seen by inspection. It is to be noted that the interpolation is not linear, so that when using this table it is essential to take out the tabular phenomenon for the latitude *less* than the true latitude.

### TABLE II—FOR LONGITUDE

Long. East or West	Difference between the times for given date and preceding date (for east longitude) or for given date and following date (for west longitude)																	
	10 <sup>m</sup>	20 <sup>m</sup>	30 <sup>m</sup>	40 <sup>m</sup>	50 <sup>m</sup>	60 <sup>m</sup>	1 <sup>h</sup> +	2 <sup>h</sup> +	3 <sup>h</sup> +	4 <sup>h</sup> +	5 <sup>h</sup> +	6 <sup>h</sup> +	7 <sup>h</sup> +	8 <sup>h</sup> +	9 <sup>h</sup> +			
	10 <sup>m</sup>	20 <sup>m</sup>	30 <sup>m</sup>	40 <sup>m</sup>	50 <sup>m</sup>	60 <sup>m</sup>	10 <sup>m</sup>	20 <sup>m</sup>	30 <sup>m</sup>	40 <sup>m</sup>	50 <sup>m</sup>	60 <sup>m</sup>	10 <sup>m</sup>	20 <sup>m</sup>	30 <sup>m</sup>	40 <sup>m</sup>		
0	0	0	0	0	0	0	0	0	0	0	0	0	0	0	0	0		
10	0	1	1	1	1	2	2	2	3	3	3	04	04	04	04	05		
20	1	1	2	2	3	3	4	4	5	6	6	07	08	08	09	10		
30	1	2	2	3	4	5	6	7	7	8	9	11	12	12	13	14		
40	1	2	3	4	6	7	8	9	10	11	12	13	14	16	17	18	19	20
50	1	3	4	6	7	8	10	11	12	14	15	17	0 18	0 19	0 21	0 22	0 24	0 25
60	2	3	5	7	8	10	12	13	15	17	18	20	22	23	25	27	28	30
70	2	4	6	8	10	12	14	16	17	19	21	23	25	27	29	31	33	35
80	2	4	7	9	11	13	16	18	20	22	24	27	29	31	33	36	38	40
90	2	5	7	10	12	15	17	20	22	25	27	30	32	35	37	40	42	45
100	3	6	8	11	14	17	19	22	25	28	31	33	0 36	0 39	0 42	0 44	0 47	0 50
110	3	6	9	12	15	18	21	24	27	31	34	37	40	43	46	49	0 52	0 55
120	3	7	10	13	17	20	23	27	30	33	37	40	43	47	50	53	0 57	1 00
130	4	7	11	14	18	22	25	29	32	36	40	43	47	51	54	0 58	1 01	1 05
140	4	8	12	16	19	23	27	31	35	39	43	47	51	54	0 58	1 02	1 06	1 10
150	4	8	13	17	21	25	29	33	38	42	46	50	0 54	0 58	1 03	1 07	1 11	1 15
160	4	9	13	18	22	27	31	36	40	44	49	53	0 58	1 02	1 07	1 11	1 16	1 20
170	5	9	14	19	24	28	33	38	42	47	52	57	1 01	1 06	1 11	1 16	1 20	1 25
180	5	10	15	20	25	30	35	40	45	50	55	60	1 05	1 10	1 15	1 20	1 25	1 30

Table II is for interpolating the L.M.T. of moonrise, moonset and the Moon's meridian passage for longitude. It is entered with longitude and with the difference between the times for the given date and for the preceding date (in east longitudes) or following date (in west longitudes). The correction is normally *added* for west longitudes and *subtracted* for east longitudes, but if, as occasionally happens, the times become earlier each day instead of later, the signs of the corrections must be reversed.

Figure 5-5. - Extract from Nautical Almanac.

LMT at YOUR position. Apply the difference in Long. between your position and the standard time meridian (arc to time) for zone time. The above moonrise problem would be worked as:

	22nd	23rd
Lat. 47° 10'S	0800	0906
(interpolated)		

$$\frac{\text{Diff. X Long.} = 14\text{m correction}}{360}$$

0800 LMT (G)	0814 LMT your position
<u>+14 corr</u>	<u>+6 Long. corr for 1°30'</u>
0814 LMT	0820 ZT of moonrise 22
	Jan.



### SELF-QUIZ #5

1. During nautical twilight the sun is \_\_\_\_\_ degrees below the horizon.

- A. 6
- B. 10
- C. 12
- D. 18

2. Sunrise and sunset are tabulated in the Nautical Almanac for the central day of each \_\_\_\_\_ day period covered.

- A. 3
- B. 4
- C. 5
- D. 6

3. The times listed in the Nautical Almanac for moonrise and moonset are \_\_\_\_\_ at the Greenwich meridian.

- A. LMT
- B. LST
- C. GMT
- D. LHT

## ANSWERS TO SELF-QUIZ #5

QUESTION	ANSWER	REFERENCE
1	C	5-1
2	A	5-2
3	A	5-6

## AZIMUTHS OF CELESTIAL BODIES

Reading Assignment: 6  
Pages 6-1 through 6-7

### OBJECTIVES

To successfully complete this assignment, you must study the text and master the following objectives:

1. Explain how to use the azimuth circle to observe the azimuth of a celestial body.
2. Explain how to compute the azimuth of a celestial body.

### AZIMUTH AND AZIMUTH ANGLE

The navigator must convert the numerical value of azimuth angle (Az - sometimes abbreviated Z) to azimuth (Zn) before the line of position for the sight can be plotted.

Azimuth angle is that internal angle of the navigational triangle at the assumed position (AP). It is formed by the segment of the meridian joining the AP to the nearer pole and the great circle from the AP to the geographical position (GP), and is measured from the meridian to the great circle. If the AP is in north latitude, the origin of measurement is north ( $000^{\circ}T$ ). If the AP is in the south latitude, the origin of measurement is south ( $180^{\circ}T$ ).

The reference for measurement is always determined by the latitude of the AP. In order to specify the true reference when using azimuth angle, prefix Az as either N or S, depending upon which pole is nearer to the AP.

If the body is east of the AP, the meridian angle is east and  $t$  is labeled E. If the body is west of the AP, the meridian angle is west and  $t$  is labeled W. To specify the direction of measurement of Az from the true reference of origin, suffix the value of Az with either E or W, according to the name of the meridian angle  $t$ . WITHOUT LABELS, Az CANNOT CONVERT to Zn.

Since azimuth (Zn) is always measured clockwise from north, the problem of converting Az to Zn is one of applying Az to the proper reference (N or S) in the proper direction (E or W) so as to define the true direction of the GP from the AP.

There are four possible combinations when converting Az to Zn. Az may be measured either eastward or westward from either north or south. DO NOT ATTEMPT to learn this conversion by cases. Simply prefix Az with N or S to agree with the name of the latitude, and suffix E or W to agree with the name of the meridian angle. If in doubt, draw a rough sketch of the situation. Figure 6-1 shows a conversion to Zn using a numerical value of Az equal to  $050.9$ .

### AZIMUTH OF THE SUN

Computation of compass error at sea depends upon the observation of the azimuth of celestial bodies. The Sun is the most commonly used for this purpose. Upon observation, the observed azimuth is recorded. The time (to the nearest second) and the DR position are also noted. With DR position and time, the navigator computes Zn. The difference between GB (gyro bearing) and Zn (true direction) is compass error (C.E.) It should be appropriately labeled. Keep in mind that accuracy depends upon the navigator's knowledge of position and the correct time.

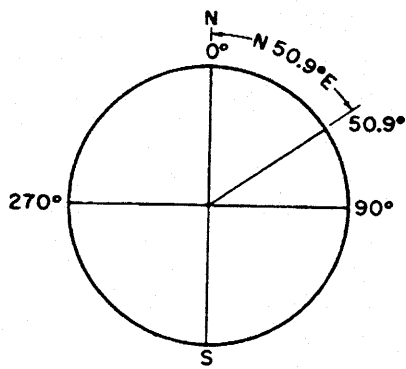

If Az is N050.9°E  
Zn is 050.9°

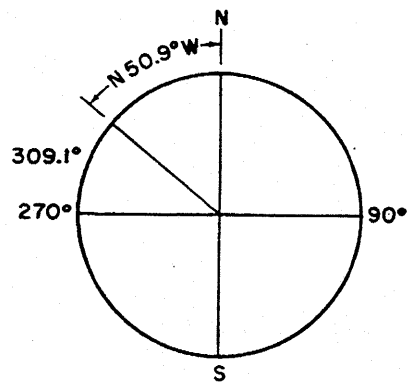

If Az is N050.9°W  
Zn is 309.1° ( $360^\circ - 050.9^\circ = 309.1^\circ$ )

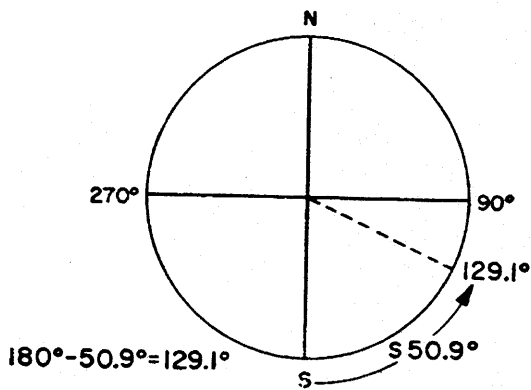

If Az is S050.9°E  
Zn is 129.1° ( $180^\circ - 050.9^\circ = 129.1^\circ$ )

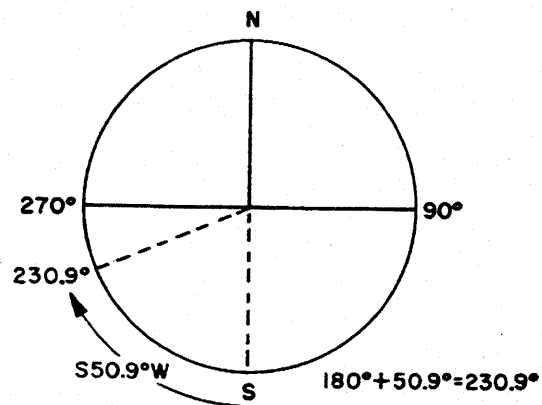

If Az is S050.9°W  
Zn is 230.9° ( $180^\circ + 050.9^\circ = 230.9^\circ$ )

Figure 6-1. - Illustrated conversion of Az to Zn (Az = 050.9).

In taking an azimuth of a celestial body, the azimuth circle is used. An azimuth circle (figure 6-2) is a nonmagnetic metal ring sized to fit upon a 7½-inch compass bowl or upon a gyro repeater. The inner lip is graduated in degrees from 0 to 360 in a counterclockwise direction for the purpose of taking relative bearings. Two sighting vanes (the forward or far vane containing a vertical wire, and the after or near vane containing a peep sight) facilitate the observation of bearings and azimuths. Two finger lugs are used to position the instrument exactly while aligning the vanes. A hinged reflector vane mounted at the base and beyond the forward vane is used for reflecting stars and planets when observing azimuths. Beneath the forward vane a reflecting mirror and the extended vertical wire are mounted, enabling

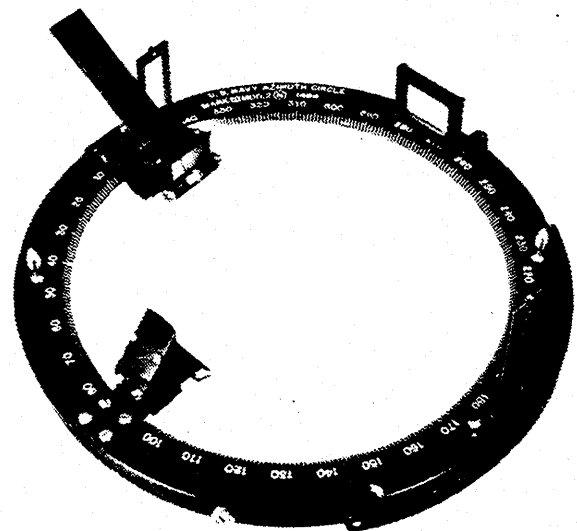

Figure 6-2. - Azimuth circle.

the navigator to read the bearing or azimuth from the reflected portion of the compass card. For observing azimuths of the Sun, an additional reflecting mirror and housing are mounted on the ring, each midway between the forward and after vanes. The Sun's rays are reflected by the mirror to the housing where a vertical slit admits a line of light. This admitted light passes through a 45° reflecting prism and is projected on the compass card from which the azimuth is directly read. In observing both bearings and azimuths, two spirit levels, which are attached, must be used to level the instrument.

### COMPUTING AN AZIMUTH OF THE SUN

On 2 January 1982, the navigator observes the Sun with an azimuth circle and gets a gyro bearing of 227.5°. The exact time of observation was 15-54-12. The 1554 DR position was 33°12.0'N, 21°22.0'W.

1. Record known information on form (figure 6-3).

2. Find ZD, GMT, and date.

3. Determine the GHA and declination of the Sun for time of observation (using figure 6-5).

4. Apply the DR longitude to the GHA and determine the exact LHA of the Sun.

a. In some cases, you must add 360° to the GHA to subtract DR longitude.

5. Record the three actual values, (LHA, DEC, and DR lat.) (See figure 6-6.)

a. Record the three lowest tab values of above. (These are the base entering arguments in Pub No. 299.)

6. Using the lowest tab values of the three entering arguments, enter Pub No. 229 and determine the Base Z. (See figure 6-4.)

7. Determine the Z on the other side of the exact values for each of the three arguments and record it under Tab Z.

Body	SUN
DR L	33 -12'.0N
DR λ	21 -22'.0W
Date(L)	2 JAN 1982
ZT	15-54-12
ZD(+or-)	+1
GMT	16-54-12
Date(G)	2 JAN 1982
Tab GHA	58 58.7
Inc'mt	13 33.0
GHA +E	72 31.7
DR λ -W	21 22.0'W
LHA	51 09.7
	d(+/-)
Tab Dec	22 54.3
d corr	-.2
Dec	S22 54.1

Figure 6-3. - Azimuth Form Part A

### CONTRARY NAME TO DEC

Dec.	33°			34°		
	Mc	d	Z	Mc	d	Z
0	31 51.4	-38.7	113.8	31 26.9	-39.5	114.4
1	31 12.7	39.0	114.7	30 47.4	39.9	115.2
2	30 33.7	39.4	115.6	30 07.5	40.2	116.1
3	29 54.3	39.7	116.5	29 27.3	40.5	117.0
4	29 14.6	40.1	117.3	28 46.8	40.8	117.8
5	28 34.5	-40.3	118.2	28 06.0	-41.1	118.6
6	27 54.2	40.7	119.0	27 24.9	41.5	119.5
7	27 13.5	41.0	119.8	26 43.4	41.7	120.3
8	26 32.5	41.2	120.7	26 01.7	41.9	121.1
9	25 51.3	41.5	121.5	25 19.8	42.2	121.9
10	25 09.8	-41.8	122.3	24 37.6	-42.5	122.7
11	24 28.0	42.0	123.1	23 55.1	42.6	123.4
12	23 46.0	42.2	123.8	23 12.5	42.9	124.2
13	23 03.8	42.5	124.6	22 29.6	43.1	125.0
14	22 21.3	42.6	125.4	21 46.5	43.4	125.7
15	21 38.7	-42.9	126.1	21 03.1	-43.5	126.5
16	20 55.8	43.1	126.9	20 19.6	43.6	127.2
17	20 12.7	43.2	127.6	19 36.0	43.9	127.9
18	19 29.5	43.5	128.4	18 52.1	44.0	128.6
19	18 46.0	43.6	129.1	18 08.1	44.2	129.4
20	18 02.4	-43.7	129.8	17 23.9	-44.3	130.1
21	17 18.7	44.0	130.5	16 39.6	44.5	130.8
22	16 34.7	44.0	131.3	15 55.1	44.6	131.5
23	15 50.7	44.2	132.0	15 10.5	44.8	132.2
24	15 06.5	44.4	132.7	14 25.7	44.8	132.9

Figure 6-4. - Extract from 229.

G.M.T.	SUN				MOON				Lat.	Twilight			Sunrise	Moonrise						
	G.H.A.		Dec.		G.H.A.		Dec.			Naut.	Civil			1	2	3	4			
	d	m	d	m	d	m	d	m		h	m	h		m	h	m	h	m		
1 00	179	10.5	S23	02.7	114	06.3	12.5	S10	21.0	10.7	56.6	N 72	08 23	10 40	12 32	12 15	11 59	11 43		
01	194	10.2		02.5	128	37.8	12.6	10	10.3	10.9	56.6	N 70	08 05	09 48	12 20	12 11	12 01	11 52		
02	209	09.9		02.3	143	09.4	12.5	9	59.4	10.9	56.6	68	07 50	09 16	12 11	12 07	12 03	12 00		
03	224	09.6		02.1	157	40.9	12.5	9	48.5	10.9	56.7	66	07 37	08 53	10 27	12 03	12 04	12 05	12 06	
21	134	09.3		01.9	172	12.4	12.6	9	37.6	11.0	56.7	64	07 26	08 34	09 49	11 56	12 01	12 06	12 11	
22	149	04.0			186	44.0	12.6	9	26.6	11.1	56.7	62	07 17	08 18	09 22	11 50	11 58	12 07	12 16	
23	164	03.7		58.0	88			9	15.5	11.1	56.7	60	07 09	08 05	09 02	11 45	11 56			
2 00	179	03.4	S22	57.8	102	43.9	12.5	S			56.8	56	06 56	07 44	08 45	11 11	11 11	12 27	13 39	
01	194	03.1		57.6	117	15.4	12.6	5	36.1	12.0	57.3	54	01 03	02 37	03 45	09 59	11 13	12 29	13 48	
02	209	02.8		57.4	131	47.0	12.5	5	24.1	12.0	57.3	54	02 40	03 34	03 34	09 56	11 12	12 30	13 51	
03	224	02.5		57.2	146	18.5	12.5	5	12.1	12.1	57.3	56	02 19	03 20	03 20	09 52	11 10	12 31	13 54	
04	239	02.2		56.9	160	50.0	12.5	5	00.0	12.1	57.4	58	01 51	03 04	03 04	09 47	11 08	12 32	13 58	
05	254	01.9		56.7	175	21.5	12.5	4	47.9	12.1	57.4	S 60	01 08	02 44	02 44	09 43	11 07	12 33	14 02	
06	269	01.6	S22	56.5	189	53.0	12.4	S	4	35.8	12.2	57.4								
07	284	01.3		56.3	204	24.4	12.5	4	23.6	12.2	57.5									
S 08	299	01.0		56.1	218	55.9	12.4	4	11.4	12.2	57.5									
A 09	314	00.8		55.8	233	27.3	12.4	3	59.2	12.3	57.5									
T 10	329	00.5		55.6	247	58.7	12.4	3	46.9	12.3	57.5									
U 11	344	00.2		55.4	262	30.1	12.4	3	34.6	12.3	57.6	N 72	13 28	13 28	15 45	21 44	23 41	25 40	01 40	
R 12	358	59.9	S22	55.2	277	01.5	12.4	S	3	22.3	12.4	57.6	N 70	14 20	16 04	21 54	23 42	25 34	01 34	
D 13	13	59.6		54.9	291	32.9	12.3	3	09.9	12.4	57.6	68	13 42	14 52	16 19	22 02	23 44	25 29	01 29	
A 14	28	59.3		54.7	306	04.2	12.4	2	57.5	12.4	57.7	66	13 42	15 16	16 31	22 08	23 45	25 24	01 24	
Y 15	43	59.0		54.5	320	35.6	12.3	2	45.1	12.4	57.7	64	14 19	15 34	16 42	22 13	23 46	25 20	01 20	
→ 16	58	58.7		54.3	335	06.9	12.3	2	32.7	12.5	57.7	62	14 46	15 50	16 51	22 18	23 46	25 17	01 17	
17	73	58.4		54.0	349	38.2	12.2	2	20.2	12.5	57.8	60	15 06	16 03	16 59	22 22	23 47	25 14	01 14	
18	88	58.1	S22	53.8	4	09.4	12.3	S	2	07.7	12.5	57.8	N 58	15 23	16 14	17 06	22 26	23 48	25 12	01 12
19	103	57.8		53.6	18	40.7	12.2	1	55.2	12.5	57.8	56	15 37	16 24	17 13	22 29	23 48	25 10	01 10	
	110	57.4		53.3	33	11.9	12.1	1	42.7	12.6	57.9	54	15 49	16 33	17 19	22 32	23 49	25 08		
20	110				47	43.0	12.2	1	30.1	12.6	57.9	52	16 00	16 41	17 24	22 34	23 49		rise	
21	133	50.4										50	16 10	16 48	17 29	22 34				
22	148	50.1		47.1	50							2	03 46	04 00	12 04	16 56	04 32	06 06		
23	163	49.8		46.8	65	01.4	11.1	4	00.7	12.8	58.1	3	04 14	04 28	12 04	17 43	05 19	07 07		
→	S.D.	16.3	d	0.2	S.D.	15.5	15.7	15.9												

54<sup>m</sup> INCREMENTS AND CORRECTIONS

<sup>m</sup> 54	SUN PLANETS	ARIES	MOON	$\frac{v}{d}$ or Corr <sup>n</sup>	$\frac{v}{d}$ or Corr <sup>n</sup>	$\frac{v}{d}$ or Corr <sup>n</sup>
00	13 30-0	13 32-2	12 53-1	0-0	0-0	6-0 5-5 12-0 10-9
01	13 30-3	13 32-5	12 53-3	0-1	0-1	6-1 5-5 12-1 11-0
02	13 30-5	13 32-7	12 53-6	0-2	0-2	6-2 5-6 12-2 11-1
03	13 30-8	13 33-0	12 53-8	0-3	0-3	6-3 5-7 12-3 11-2
04	13 31-0	13 33-2	12 54-1	0-4	0-4	6-4 5-8 12-4 11-3
05	13 31-3	13 33-5	12 54-3	0-5	0-5	6-5 5-9 12-5 11-4
06	13 31-5	13 33-7	12 54-5	0-6	0-5	6-6 6-0 12-6 11-4
07	13 31-8	13 34-0	12 54-8	0-7	0-6	6-7 6-1 12-7 11-5
08	13 32-0	13 34-2	12 55-0	0-8	0-7	6-8 6-2 12-8 11-6
09	13 32-3	13 34-5	12 55-2	0-9	0-8	6-9 6-3 12-9 11-7
10	13 32-5	13 34-7	12 55-5	1-0	0-9	7-0 6-4 13-0 11-8
11	13 32-8	13 35-0	12 55-7	1-1	1-0	7-1 6-4 13-1 11-9
→ 12	13 33-0	13 35-2	12 56-0	1-2	1-1	7-2 6-5 13-2 12-0
13	13 33-3	13 35-5	12 56-2	1-3	1-2	7-3 6-6 13-3 12-1
14	13 33-5	13 35-7	12 56-4	1-4	1-3	7-4 6-7 13-4 12-2

Figure 6-5. - Extracts from the National Almanac 1982.

	Actual	Base Arguments	Base Z	Tab* Z	Z Diff.	Increments	Correction (Z Diff × Inc. ÷ 60)
Dec.	22 54.1	22	131.3	132.0	+ .7	54.1	+ .63
DR Lat.	33 12.0	33	131.3	131.5	+ .2	12.0	+ .04
LHA	51 09.7	51	131.3	130.5	- .8	09.7	- .13
						<b>Total Corr.</b>	<b>+ .5</b>

Base Z	131.3
Corr.	+ .5
Z	<u>131.8W</u>
Zn	228.2
Zn (pgc)	<u>227.5</u>
Gyro Error	.7E

\*Respondent for two base arguments and 1° change from third base argument, in vertical order of Dec., DR Lat., and LHA.

Figure 6-6. - Azimuth form Part B.

8. Determine the Z difference along with sign between the Base Z and Tab Z.

9. Multiply the increments and the Z difference for each argument, then divide each answer by 60 to obtain the correction for each.

10. Add the three corrections and determine the total correction. (See figure 6-6.)

11. Apply the total correction to the Base Z to determine the Z.

12. Convert the Z to Zn, according to rules in figure 6-7.

NORTH LAT

LHA greater than 180° ..... Zn = Z  
 LHA less than 180° ..... Zn = 360° - Z

SOUTH LAT

LHA greater than 180° ..... Zn = 180° - Z  
 LHA less than 180° ..... Zn = 180° + Z

Figure 6-7. - LHA conversion to Zn.

13. Compare the GB and the Zn to determine the amount of gyro error.

14. Determine the direction of the gyro error. COMPASS BEST ERROR WEST, COMPASS LEAST ERROR EAST.

**AZIMUTH BY POLARIS**

Polaris is part of the Little Dipper, or properly known as Ursa Minor. Polaris is not usually seen until the sky has become quite dark. No star is located exactly at either pole, but Polaris is less than one degree from the north celestial pole. It alternately transits the upper and lower branches of each celestial meridian in completing its diurnal circle. Obtaining a meaningful azimuth by Polaris in latitudes above 60° north is virtually impossible because of its high altitude in these higher latitudes.

The true azimuth of Polaris is tabulated in the Nautical Almanac for northern latitudes up to 65°. Polaris, the "north Star," is always within 1° of true north in these latitudes, and observations of it provide a convenient means of checking the compass. An extract from the Nautical Almanac Polaris table, with the azimuth table at the bottom is shown in figure 6-8.

The entering arguments in the Nautical Almanac azimuth table for Polaris are: LHA of Aries and latitude (at intervals of 5°, 10°, or 20°, eye interpolation is made, if necessary).

**COMPUTING AN AZIMUTH OF POLARIS**

The navigator of a ship at Lat. 43°-14.2'N, Long. 80° - 18.2'W observes Polaris

# POLARIS (POLE STAR) TABLES, 1982

FOR DETERMINING LATITUDE FROM SEXTANT ALTITUDE AND FOR AZIMUTH

L.H.A. ARIES	0° - 9	10° - 19	20° - 29	30° - 39	40° - 49	50° - 59	60° - 69	70° - 79	80° - 89	90° - 99	100° - 109	110° - 119
	$a_0$	$a_0$	$a_0$	$a_0$	$a_0$	$a_0$	$a_0$	$a_0$	$a_0$	$a_0$	$a_0$	$a_0$
0	18.1	14.0	11.3	10.0	10.2	12.0	15.1	19.6	25.4	32.1	39.7	47.8
1	17.7	13.7	11.1	09.9	10.3	12.2	15.5	20.2	26.0	32.8	40.5	48.6
2	17.2	13.4	10.9	09.9	10.4	12.5	15.9	20.7	26.6	33.6	41.3	49.5
3	16.8	13.0	10.7	09.9	10.6	12.8	16.3	21.2	27.3	34.3	42.1	50.3
4	16.3	12.7	10.6	09.9	10.7	13.1	16.8	21.8	28.0	35.0	42.9	51.1
5	15.9	12.5	10.4	09.9	10.9	13.4	17.2	22.4	28.6	35.8	43.7	52.0
6	15.5	12.2	10.3	09.9	11.1	13.7	17.7	22.9	29.3	36.6	44.5	52.8
7	15.1	11.9	10.2	10.0	11.3	14.0	18.2	23.5	30.0	37.3	45.3	53.7
8	14.7	11.7	10.1	10.1	11.5	14.4	18.6	24.1	30.7	38.1	46.1	54.5
9	14.4	11.5	10.1	10.1	11.7	14.7	19.1	24.7	31.4	38.9	47.0	55.4
10	14.0	11.3	10.0	10.2	12.0	15.1	19.6	25.4	32.1	39.7	47.8	56.2
Lat.	$a_1$	$a_1$	$a_1$	$a_1$	$a_1$	$a_1$	$a_1$	$a_1$	$a_1$	$a_1$	$a_1$	$a_1$
0	0.5	0.6	0.6	0.6	0.6	0.5	0.5	0.4	0.3	0.3	0.2	0.2
10	.5	.6	.6	.6	.6	.6	.5	.4	.4	.3	.3	.3
20	.5	.6	.6	.6	.6	.6	.5	.5	.4	.4	.3	.3
30	.6	.6	.6	.6	.6	.6	.5	.5	.5	.4	.4	.4
40	0.6	0.6	0.6	0.6	0.6	0.6	0.6	0.5	0.5	0.5	0.5	0.5
45	.6	.6	.6	.6	.6	.6	.6	.6	.6	.5	.5	.5
50	.6	.6	.6	.6	.6	.6	.6	.6	.6	.6	.6	.6
55	.6	.6	.6	.6	.6	.6	.6	.6	.7	.7	.7	.7
60	.6	.6	.6	.6	.6	.6	.7	.7	.7	.7	.8	.8
62	0.7	0.6	0.6	0.6	0.6	0.6	0.7	0.7	0.7	0.8	0.8	0.8
64	.7	.6	.6	.6	.6	.6	.7	.7	.8	.8	.9	.9
66	.7	.6	.6	.6	.6	.6	.7	.8	.8	.9	.9	1.0
68	0.7	0.6	0.6	0.6	0.6	0.7	0.7	0.8	0.9	0.9	1.0	1.0
Month	$a_2$	$a_2$	$a_2$	$a_2$	$a_2$	$a_2$	$a_2$	$a_2$	$a_2$	$a_2$	$a_2$	$a_2$
Jan.	0.7	0.7	0.7	0.7	0.7	0.7	0.7	0.7	0.7	0.7	0.6	0.6
Feb.	.6	.6	.7	.7	.7	.7	.8	.8	.8	.8	.8	.8
Mar.	.5	.5	.6	.6	.7	.7	.7	.8	.8	.9	.9	.9
Apr.	0.3	0.4	0.4	0.5	0.5	0.6	0.7	0.7	0.8	0.8	0.9	0.9
May	.2	.2	.3	.3	.4	.5	.5	.6	.7	.7	.8	.9
June	.2	.2	.2	.2	.3	.3	.4	.5	.5	.6	.7	.8
July	0.2	0.2	0.2	0.2	0.2	0.2	0.3	0.3	0.4	0.5	0.5	0.6
Aug.	.3	.3	.3	.2	.2	.2	.2	.3	.3	.3	.4	.4
Sept.	.5	.5	.4	.4	.3	.3	.3	.3	.3	.3	.3	.3
Oct.	0.7	0.6	0.6	0.5	0.5	0.4	0.4	0.3	0.3	0.3	0.3	0.3
Nov.	0.9	0.8	.8	.7	.6	.6	.5	.5	.4	.4	.3	.3
Dec.	1.0	1.0	0.9	0.9	0.8	0.8	0.7	0.6	0.6	0.5	0.4	0.4
Lat.	AZIMUTH											
0	0.4	0.3	0.1	0.0	359.8	359.7	359.6	359.5	359.4	359.3	359.2	359.2
20	0.4	0.3	0.1	0.0	359.8	359.7	359.5	359.4	359.3	359.2	359.2	359.1
40	0.5	0.3	0.2	0.0	359.8	359.6	359.4	359.3	359.2	359.1	359.0	358.9
50	0.6	0.4	0.2	0.0	359.7	359.5	359.3	359.1	359.0	358.9	358.8	358.7
55	0.7	0.5	0.2	0.0	359.7	359.5	359.2	359.0	358.9	358.7	358.6	358.6
60	0.8	0.5	0.2	0.0	359.7	359.4	359.1	358.9	358.7	358.6	358.4	358.4
65	0.9	0.6	0.3	359.9	359.6	359.3	359.0	358.7	358.5	358.3	358.2	358.1

$$\text{Latitude} = \text{Apparent altitude (corrected for refraction)} - 1^\circ + a_0 + a_1 + a_2$$

The table is entered with L.H.A. Aries to determine the column to be used; each column refers to a range of 10°.  $a_0$  is taken, with mental interpolation, from the upper table with the units of L.H.A. Aries in degrees as argument;  $a_1$ ,  $a_2$  are taken, without interpolation, from the second and third tables with arguments latitude and month respectively.  $a_0$ ,  $a_1$ ,  $a_2$  are always positive. The final table gives the azimuth of *Polaris*.

Figure 6-8. - Extract from Nautical Almanac, 1982.



when the GHA is  $194^{\circ}-29.6'$ . The observed azimuth by gyro repeater (GB) is  $358.0^{\circ}$ .

Using the exact DR longitude (note that an assumed position is NOT used), determine the LHA of Aries for the time of observation. Turn to the three pages of Polaris Tables toward the back of the Nautical Almanac, and locate the column heading pertaining to the computed value of LHA of Aries. In this case, it occurs on the first page of the Tables. (See figure 6-8.) Using the column

DR Lat.	$43^{\circ} - 14.2'N$
DR Long.	$80^{\circ} - 18.2'W$
GHA Aries	$194^{\circ} - 29.6'$
DR Long.	$80^{\circ} - 18.2'W$
GHA Aries	$194^{\circ} - 29.6'$
DR Long.	$80^{\circ} - 18.2'W$
LHA Aries	$114^{\circ} - 11.4'W$
Zn	$358.9^{\circ}$ : from table
GB	$358.0^{\circ}$
GE	$0.9^{\circ} E$

with a heading of LHA of Aries of  $110^{\circ} - 119^{\circ}$  follow down the column to the appropriate latitude. Using interpolation by eye for latitude, the value of  $358.9^{\circ}$  is found. This is the true azimuth of Polaris. The gyro error is determined by comparing this with the azimuth observed using the gyro repeater.

Due to the limitations in the precision with which the compass or a repeater can be read, the error is usually rounded to the nearest half degree, or  $1.0^{\circ}E$ . It is labeled either east or west, depending on whether the true azimuth is greater than or less than the observed azimuth.

In practice, it is difficult to observe Polaris accurately for azimuth unless the ship is in a lower latitude. This is due to the difficulty of observing accurate azimuths at higher altitudes. However, Polaris serves as a useful check on the compass at any time it can be observed.

### SELF-QUIZ #6

1. The instrument used to observe the azimuth of a celestial body is called a/an \_\_\_\_\_.

- A. bearing circle
- B. azimuth circle
- C. relative circle
- D. angle circle

2. Obtaining an azimuth by Polaris is NOT recommended in latitudes above \_\_\_\_\_ degrees north.

- A. 30
- B. 40
- C. 50
- D. 60

3. The star Polaris is located in which constellation?

- A. Ursa Minor
- B. Ursa Major
- C. Orion
- D. Cassiopeia

4. When you observe an azimuth, what degree of accuracy is considered sufficient for all practical purposes?

- A. .1
- B. .3
- C. .5
- D. 1.0

## ANSWERS TO SELF-QUIZ #6

QUESTION	ANSWER	REFERENCE
1	B	6-2
2	D	6-5
3	A	6-5
4	C	6-7

## DETERMINATION OF LATITUDE

Reading Assignment: 7  
Pages 7-1 through 7-11

### OBJECTIVES

To successfully complete this assignment, you must study the text and master the following objectives:

1. Define a latitude line.
2. Outline the procedures for obtaining a latitude line by using the sun and by Polaris.

### INTRODUCTION

Since the latitude of a position may be determined by finding the distance between the equinoctial and the zenith, one needs to know only the declination and zenith distance (co-altitude) of a body to determine latitude. The procedure involved has been used by mariners for many centuries because of its simplicity. Before the discovery of the Sumner line, and prior to the Harrison chronometer, longitude was most difficult to compute. Accordingly, early mariners seized upon the technique of "latitude or parallel sailing," by which they traveled north or south to the known latitude of their destination, then east or west as appropriate, often using the meridian sight as their only celestial computation. The meridian sight as described herein is applicable to all celestial bodies, although in practice it is primarily used with the sun.

As described later in this assignment latitude by Polaris, a polar star, is a special case of the meridian sight. Procedurally it is a different computation. With this brief introduction, the meridian sight is now considered.

### LATITUDE BY MERIDIAN SIGHT

When the altitude of a celestial body is measured as it transits the meridian, we speak of the observation, and the subsequent solution for a line of position, as a "meridian sight." This sight includes observations of bodies on the lower branch of the meridian

(lower transit) as well as on the upper branch (upper transit). Circumpolar stars may be observed on either branch of the celestial meridian. In practice, however, bodies are seldom observed on the lower branch, and the sun is normally the only body observed. In polar latitudes, when the declination of the sun corresponds in name to the latitude of the observer, the sun may be observed when in lower transit, but generally, meridian sights of the sun are made when it is in upper transit (LAN).

The meridian sight is important for the following reasons:

- a. It provides a celestial LOP without resort to trigonometry.
- b. The intersection of the LOP, obtained at LAN, and advanced morning sun lines, establishes a celestial running fix.
- c. It is practically independent of time.
- d. The knowledge of the approximate position is unnecessary.
- e. The LOP is a latitude line, and is useful in latitude or parallel sailing.
- f. A latitude observation is obtained when the celestial body is either due north or south of the observer. When, reduced, such an observation yields an LOP extending in an east-west direction. This is termed a latitude line.

To observe a body when on the meridian we must first determine the time of local transit. This may be accomplished by one of the three following methods:

### **FOLLOWING TO MAXIMUM ALTITUDE**

The oldest and most common method of determining meridian altitude of the sun is known as following to maximum altitude. It is recommended because of its adaptability to various conditions, and because its use develops an insight into how the altitude varies near the time of apparent noon.

AT approximately 10 minutes before watch time of LAN, the observer contacts the sun's lower limb, with the horizon in the sextant. The observer then swings the sextant from side to side, and adjusts it until the sun, seen moving in an arc, just touches the horizon at the lowest part of the arc. This procedure is called "swinging the arc."

As the sun continues rising, a widening space appears between its lower limb and the horizon. Adjusting the tangent screw, the observer keeps this space closed and maintains the sun in contact with the horizon. The change in altitude becomes slower and slower, until the sun "hangs." While it is hanging, the observer swings the sextant to make certain of accurate contact with the horizon. This observation is continued until the sun dips, which is a signal that the sun is now beginning to lose altitude. The sextant then shows the maximum altitude attained.

### **INSTANT OF TRANSIT**

The method of determining the exact instant of transit is explained by Dutton in connection with Todd's method of finding the interval to LAN. An observation taken at the exact instant of transit gives the maximum altitude. Under ordinary conditions, an error of 1 minute (more or less) does not affect the result.

### **NUMEROUS SIGHTS**

The method of taking numerous sights is a modification of the maximum altitude method. It is useful under conditions where heavy sea, clouds, and the like may make steady observation impossible. Well before

watch time of LAN, the observer begins taking a series of altitudes. Their number depends on the difficulties of the situation and the possible error in computed time of transit. The observer reads off the altitudes to a recording assistant, turning the tangent screw slightly after each observation to ensure that the next altitude is an independent sight. Observations are discontinued when the altitude definitely shows signs of decreasing.

Under favorable conditions, even a series of skillfully taken observations may show an occasional, erratic deviation from the normal gradual rise and fall. After sights showing a radical difference from the preceding or succeeding series are discarded, however, the hang should become evident, and it should be possible to judge the maximum altitude. The figure selected will probably be less than the altitude shown in one observation and more than the next below it. The result should give latitude with an error no more than 1'. This reading is considerably more accurate than could be obtained by a single sight under the conditions described.

### **SOLVING THE ASTRONOMICAL TRIANGLE**

When you calculate and plot your line of position, you are, in effect, solving the astronomical triangle. Thirty-odd methods of arriving at solutions have been devised since the first edition of Bowditch appeared in 1802. Although the methods may vary, two basic premises remain the same:

1. A single observation gives only a single LOP which is at right angles to the azimuth of the observed body.
2. To establish an LOP, the observer must observe, time, and correct the altitude. From the Nautical Almanac, the observer must determine the declination and GHA of the observed body, and calculate its LHA. With these values, the tables are used to find the azimuth and the altitude intercept (a).

The principles on which the tables are based are the result of years of development in the science of navigation. In the Coast Guard, most tables have been superseded in favor of PUB. 229 whose use is explained

later. A few of the older methods are described in this reading assignment.

### TIME SIGHT METHOD

In the time sight method, the latitude assumed is that of the DR. Local time is computed from the observation, Greenwich time is determined by the chronometer, and the difference in the two readings is used to find the longitude. The resulting fix is only as accurate as the assumed latitude. If two different latitudes are assumed and two points computed, the line drawn between them is as accurate an LOP as you can get by any method. Time sights and supporting details to make the method practical are given in Bowditch, which also contains all the necessary tables.

The time sight method is rather long. Other disadvantages of this procedure are that it cannot be used within an hour or more of the meridian, and it means using sidereal time. For these reasons, it is not an accepted element in modern Coast Guard navigation; consequently, it requires no further discussion here.

### L. A. N. OR NOON SIGHT

The noon sight, generally called LAN (for LOCAL APPARENT NOON), is a convenient and simple element in navigation dating back several centuries. It results in a line of position which coincides with the ship's latitude. Before convenient methods of calculating the longitude were devised, many shipmasters customarily made port by running down the latitude of the desired landfall verified daily by noon sight.

Accuracy of the latitude obtained by LAN depends only upon the accuracy of the sun's maximum true altitude, and the accuracy with which its declination can be determined. When the sun is on the observer's meridian, the ship's latitude is the sum or difference of the declination and the distance the ship is north or south of the sun, depending upon certain rules to be discussed later.

There are three possible situations which may be encountered in solving LAN; (1) when the latitude is greater than

the declination, but of the same name, (2) when the declination is greater than the latitude, but of the same name, and (3) when latitude and declination are of opposite names. Each of these cases has a different rule, and you can't do much else but try to memorize each of them.

The value "z" in the L.A.N. problem is obtained by subtracting the corrected altitude from  $90^\circ$ ; in other words, "z" (for ZENITH DISTANCE) always equals  $90^\circ$  minus the corrected altitude.

### RULES FOR SOLVING L. A. N.

The situation wherein latitude is greater than the declination but of the same name is called CASE I, and the rule for that case is:

$$\text{Lat.} = \text{decl.} + z$$

Let's see how a problem under Case I would be solved, before taking up the other two rules.

The upper drawing in figure 7-1 shows you a Case I situation. Both ship and sun are in north latitude, and the ship is farther north than the sun. Consequently, latitude is greater than declination, and both have the same name. Corrected altitude is  $60^\circ$  N; declination,  $20^\circ$  N.

True altitude of zenith always	$90^\circ$
Corrected altitude of sun	$60^\circ$
"z" (always $90^\circ$ -the above)	$30^\circ$

To repeat, the rule for this case is:

$$\text{Lat.} = \text{decl.} + z$$

Therefore:

decl.	$20^\circ$ N
"z"	$30^\circ$ N
Latitude (decl. + "z")	$50^\circ$ N

Figure 7-1 further illustrates the Case I situation in the case marked "x" above the equator, near the center of the chart. The vertical line through the ship and the sun's G.P. represent the arcs in the upper drawing; it is the meridian of the observer. Its east-west location might be in any other possible

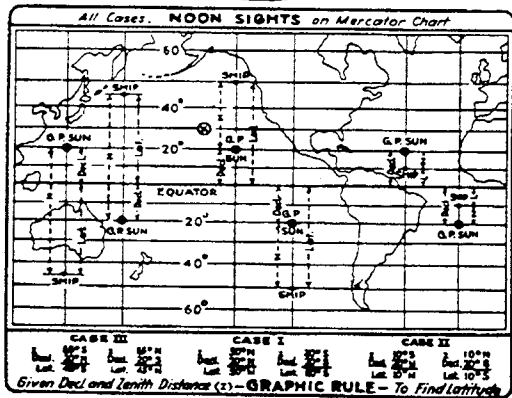
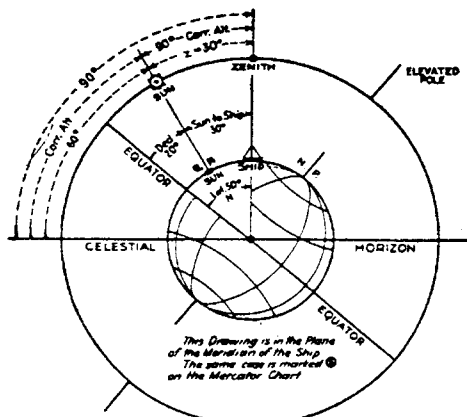

Figure 7-1. - L. A. N.

longitude of the ship. The respective positions of the sun's G.P. and the ship clearly show in the case "z" and the declination must be added.

Case II: Declination greater than latitude but of the same name. This would be the case in figure 7-1 if the ship were SOUTH of the sun's G.P., but still in north latitude. The rule for case II is:

$$\text{Lat.} = \text{decl.} - "z"$$

In this case the resulting latitude would, of course, have the same name as the declination.

Case III: Latitude and declination of opposite names. The rule for this case is:

$$\text{Lat.} = "z" - \text{decl.}$$

Subtract the declination from "z," and give the resulting latitude the same name as "z".

There is a possible fourth case, involving a midnight sight of the sun as it is seen below the pole from high latitude, but

this case involves a rare situation which need not be discussed.

### PROCEDURE IN L. A. N.

You can readily see that latitude by L.A.N. is rather a simple affair, requiring only the most elementary knowledge of arithmetic. However, there are certain procedural aspects of the situation which you must know. You must be able, first of all, to calculate the time of local apparent noon, when the sun will be at its maximum altitude, exactly on the meridian. Watch time of local apparent noon may be determined in advance by what is called the FIRST ESTIMATE, SECOND ESTIMATE method.

### DETERMINING TIME OF L. A. N.

Before making a meridian altitude observation of the sun, the navigator usually determines the ZT of the phenomenon. This may be done by obtaining the LMT of the occurrence (listed under "Mer. Pass.") from the appropriate daily page of the Nautical Almanac, and converting it to ZT. If accuracy to within a few minutes is acceptable, you can determine ZT by applying to the LMT the value of  $d\lambda$ , converted to time units, between the 1200 DR longitude, and the longitude of the central meridian of the time zone. If greater accuracy is desired, the ZT determined above is considered to be the first estimate, and a second estimate is made. To accomplish the second step, plot the DR position for the ZT found by the first estimate, and determine the  $d\lambda$  between the longitude of that position and the longitude of the central meridian of the time zone. This value of  $d\lambda$ , converted to time units, is applied to the LMT obtained from the Nautical Almanac, and results in a second estimate of the time of meridian transit which is accurate to within + 1 minute. Since the navigator usually begins the observation of the sun several minutes before the actual time of meridian passage, many navigators do not consider the increased accuracy of a second estimate necessary.

The navigator of a ship whose 1200 DR position on 25 DEC 1982 will be Lat. 26°-14.1'N, 77°-15.2'W, plans to make a meridian

altitude observation of the sun (LL). The ship is on course 271<sup>OT</sup>, speed 20.0 Knots.

Find: The GMT of transit, to the nearest minute.

Solution: (See figure 7-2.) Enter the appropriate daily page of the Nautical Almanac and extract and record the tabulated LMT of meridian passage for the date in question. In this case the tabulated LMT on 25 Dec 1982 is 1200. (See figure 7-3.) Next, apply to the tabulated LMT the difference, in time units, between the 1200 DR longitude and the standard meridian of the zone. In this case the time difference is 9m (since 77°-15.2'W - 75°-00.0'W = 2°15.2' which = 9m 1s or 9m rounded off) (See figure 7-4), and it is added to the tabulated LMT because the DR longitude is west of the standard meridian. The zone time thus found is 1209. Since ZT to the nearest whole minute is desired, ZT 1209 is considered to be the first estimate.

FIRST ESTIMATE	
Date	25 DEC 82
DR Latitude	26° 14.1' N
DR λ	77° 15.2' W
Central Meridian	75° 00.0' W
dλ (arc)	2° 15.2' W
dλ (time)	9m 1s
Mer. Pass. (LMT)	12-00-00
ZT (est) 1st	12-09-01
SECOND ESTIMATE	
DR λ	77° 19.0' W
Central Meridian	75° 00.0' W
dλ (arc)	2° 19.0' W
dλ (time)	9m 16s
Mer. Pass. (LMT)	12-00-00
ZT (est) 2nd	12-09-16
ZT (actual)	12-09-16
ZD (W+, E-)	+5
GMT	17-09-16
Date (GMT)	25 DEC 82

Figure 7-2. - First/Second Estimate form.

Plot the DR position for this time from which the 1209 DR longitude is found to be 77 - 19.0W. The DR longitude, in time units, between this position and the central meridian of the time zone is found to be (+)9 minutes, to the nearest whole minute. By applying this value to LMT, you can find that the second estimate of the ZT of transit is 1209.

To complete the example, the actual zone time of the observation recorded when the sun appeared at its greatest altitude was 12-09-16 and the sextant altitude *hs* of the lower limb was 40° -10.0'. The sextant IC was +1.0', and height of eye is 41'. The true declination for the zone time of observation is found in the Nautical Almanac to be S23°-23.9' for 12 hours. (See figure 7-3.) Then go to the increments for 9 minutes in the back for the *d* corr which is 0.0. (See figure 7-5.) After applying the IC, dip, and altitude corrections to *hs* (figure 7-6a and b), an *Ho* of 40° -19.9' results. Subtracting this *Ho* from 90° yields the zenith distance 49° -40.1'N, labeled "north" because the DR position is north of the GP of the sun. Inasmuch as the zenith distance and declination are of contrary name, the true declination is subtracted from the larger zenith distance to yield the latitude 26° -16.2'N. The completed sight form now appears as in figure 7-7.

### LATITUDE BY POLARIS

In the diagram used in the derivation of formula for the solution of meridian sights, we found that arc ZQ equals the latitude of the observer. We can prove geometrically, using the same diagram, that the altitude of the elevated pole equals the declination of the zenith (arc ZQ), and also the latitude.

Although P<sub>n</sub> and P<sub>s</sub> are not well defined positions which make measurement feasible, a second magnitude star called Polaris (north star) provides a reference for measurement in the Northern Hemisphere. Polaris has no counterpart in the Southern Hemisphere. Polaris may be located in the northern sky between the constellation Ursa Major (big dipper) and Cassiopeia. The two stars in the bowl of the dipper at the greatest distance from the handle, point toward the north star.



1982 DECEMBER 24, 25, 26 (FRI., SAT., SUN.)

G.M.T.	SUN		MOON				Lat.	Twilight		Sunrise	Moonrise					
	G.H.A.	Dec.	G.H.A.	V	Dec.	d		H.P.	Naut.		Civil	24	25	26	27	
									h m		h m	h m	h m	h m	h m	h m
24 00	180 11.1	S23 25.7	84 02.8	14.2	S 2	14.9	12.7	56.3	N 72	08 27	10 58	12 42	12 22	11 57	11 20	
01	195 10.8	25.7	98 36.0	14.1	2	02.2	12.8	56.4	N 70	08 07	09 55	12 43	12 29	12 14	11 53	
02	210 10.5	25.6	113 09.1	14.2	1	49.4	12.8	56.4	68	07 51	09 20	12 43	12 35	12 27	12 17	
03	225 10.2	25.6	127 42.3	14.0	1	36.6	12.8	56.5	64	07 38	08 55	10 36	12 44	12 41	12 38	
04	240 09.9	25.6	142 15.3	14.1	1	23.8	12.8	56.5	62	07 27	08 35	09 53	12 44	12 45	12 47	
05	255 09.6	25.5	156 48.4	14.0	1	11.0	12.9	56.5	60	07 17	08 19	09 25	12 44	12 49	12 55	
06	270 09.3	S23 25.5	171 21.4	14.0	S 0	58.1	12.8	56.6	N 58	07 09	08 06	09 03	12 44	12 53	13 02	
07	285 08.9	25.4	185 54.4	13.9	0	45.3	12.9	56.6	56	07 01	07 54	08 46	12 45	12 56	13 08	
08	300 08.6	25.4	200 27.3	13.9	0	32.4	13.0	56.6	54	06 55	07 44	08 31	12 45	12 58	13 14	
09	315 08.3	25.3	215 00.2	13.9	0	19.4	12.9	56.7	52	06 48	07 35	08 19	12 45	13 01	13 19	
F 10	330 08.0	25.3	229 33.1	13.8	S 0	06.5	13.0	56.7	50	06 43	07 27	08 07	12 45	13 03	13 23	
R 11	345 07.7	25.3	244 05.9	13.8	N 0	06.5	12.9	56.7	45	06 37	07 19	07 58	12 45	13 05	13 27	
D 12	0 07.4	S23 25.2	258 38.7	13.7	N 0	19.4	13.0	56.8	N 40	06 26	07 03	07 37	12 46	13 10	13 36	
A 13	15 07.1	25.2	273 11.4	13.7	0	32.4	13.0	56.8	35	06 15	06 49	07 20	12 46	13 13	13 44	
Y 14	30 06.8	25.1	287 44.1	13.7	0	45.4	13.0	56.9	30	06 06	06 38	07 06	12 46	13 17	13 50	
15	45 06.5	25.1	302 16.8	13.6	0	58.4	13.1	56.9	20	05 57	06 27	06 53	12 46	13 20	13 56	
16	60 06.1	25.0	316 49.4	13.6	1	11.5	13.0	56.9	N 10	05 47	06 08	06 32	12 47	13 25	14 06	
17	75 05.8	25.0	331 22.0	13.5	1	24.5	13.1	57.0	0	05 24	05 51	06 14	12 47	13 29	14 14	
18	90 05.5	S23 24.9	345 54.5	13.5	N 1	37.6	13.0	57.0	S 10	05 07	05 34	05 56	12 47	13 33	14 23	
19	105 05.2	24.9	0 27.0	13.4	1	50.6	13.1	57.0	20	04 48	05 16	05 39	12 48	13 38	14 31	
20	120 04.9	24.8	14 59.4	13.4	2	03.7	13.1	57.1	30	04 26	04 55	05 20	12 48	13 42	14 40	
21	135 04.6	24.8	29 31.8	13.3	2	16.8	13.1	57.1	30	03 57	04 30	04 58	12 49	13 48	14 50	
22	150 04.3	24.7	44 04.1	13.3	2	29.9	13.1	57.2	35	03 38	04 15	04 45	12 49	13 51	14 56	
23	165 04.0	24.7	58 36.4	13.2	2	43.0	13.1	57.2	40	03 15	03 57	04 30	12 49	13 54	15 03	
25 00	180 03.7	S23 24.6	73 08.6	13.2	N 2	56.1	13.1	57.2	45	02 44	03 34	04 11	12 50	13 59	15 11	
01	195 03.4	24.6	87 40.8	13.1	3	09.2	13.1	57.3	S 50	02 44	03 04	03 49	12 50	14 04	15 21	
02	210 03.0	24.5	102 12.9	13.1	3	22.3	13.1	57.3	52	01 59	02 49	03 38	12 50	14 06	15 25	
03	225 02.7	24.4	116 45.0	13.0	3	35.4	13.1	57.3	54	01 31	02 49	03 38	12 51	14 08	15 30	
04	240 02.4	24.4	131 17.0	12.9	3	48.5	13.1	57.4	56	00 44	02 31	03 26	12 51	14 11	15 35	
05	255 02.1	24.3	145 48.9	12.9	4	01.6	13.2	57.4	58	00 48	02 31	03 26	12 51	14 14	15 42	
06	270 01.8	S23 24.3	160 20.8	12.8	N 4	14.8	13.1	57.5	S 60	00 48	02 34	03 24	12 51	14 18	15 49	
07	285 01.5	24.2	174 52.6	12.8	4	27.9	13.1	57.5	Lot	Sunset	Twilight		Moonset			
S 08	300 01.2	24.2	189 24.4	12.7	4	41.0	13.1	57.5	Sunset	Civil	Naut.	24	25	26	27	
A 09	315 00.9	24.1	203 56.1	12.6	4	54.1	13.1	57.6	N 72	13 02	15 33	25 50	01 50	03 55	06 21	
T 10	330 00.6	24.0	218 27.7	12.6	5	07.2	13.1	57.6	N 70	14 05	15 53	25 46	01 46	03 41	05 50	
U 11	345 00.2	24.0	232 59.3	12.5	5	20.3	13.1	57.7	68	14 00	16 09	00 00	01 42	03 30	05 27	
D 12	359 59.9	S23 23.9	247 30.8	12.4	N 5	33.4	13.1	57.7	66	13 24	15 05	16 22	00 03	01 39	05 09	
A 13	14 59.6	23.8	262 02.2	12.3	5	46.5	13.0	57.7	64	14 07	15 25	16 33	00 05	01 36	04 55	
Y 14	29 59.3	23.8	276 33.5	12.3	5	59.5	13.1	57.8	62	14 35	15 41	16 43	00 06	01 34	04 43	
15	44 59.0	23.7	291 04.8	12.2	6	12.6	13.1	57.8	60	14 57	15 54	16 51	00 08	01 32	04 33	
16	59 58.7	23.6	305 36.0	12.2	6	25.7	13.0	57.9	N 58	15 14	16 06	16 59	00 09	01 30	04 24	
17	74 58.4	23.6	320 07.2	12.1	6	38.7	13.0	57.9	56	15 29	16 16	17 05	00 10	01 29	04 17	
18	89 58.1	S23 23.5	334 38.3	12.0	N 6	51.7	13.1	58.0	54	15 41	16 25	17 12	00 11	01 27	04 10	
19	104 57.8	23.4	349 09.3	11.9	7	04.8	12.9	58.0	52	15 53	16 34	17 17	00 12	01 26	04 04	
20	119 57.5	23.4	3 40.2	11.8	7	17.7	13.0	58.0	50	16 02	16 41	17 23	00 13	01 25	04 03	
21	134 57.2	23.3	18 11.0	11.8	7	30.7	13.0	58.1	45	16 23	16 57	17 34	00 15	01 22	03 46	
22	149 56.8	23.2	32 41.8	11.7	7	43.7	12.9	58.1	N 40	16 40	17 11	17 45	00 16	01 20	03 37	
23	164 56.5	23.1	47 12.5	11.6	7	56.6	13.0	58.2	35	16 54	17 22	17 54	00 18	01 18	03 28	
26 00	179 56.2	S23 23.1	61 43.1	11.5	N 8	09.6	12.8	58.2	30	17 07	17 33	18 03	00 19	01 17	03 21	
01	194 55.9	23.0	76 13.6	11.4	8	22.4	12.9	58.2	20	17 28	17 52	18 19	00 21	01 14	03 08	
02	209 55.6	22.9	90 44.0	11.4	8	35.3	12.9	58.3	N 10	17 46	18 09	18 36	00 22	01 11	02 57	
03	224 55.3	22.8	105 14.4	11.2	8	48.2	12.8	58.3	0	18 04	18 26	18 53	00 24	01 09	02 47	
04	239 55.0	22.8	119 44.6	11.2	9	01.0	12.8	58.4	S 10	18 21	18 44	19 11	00 26	01 07	02 37	
05	254 54.7	22.7	134 14.8	11.1	9	13.8	12.8	58.4	20	18 40	19 05	19 34	00 27	01 04	02 26	
06	269 54.4	S23 22.6	148 44.9	11.0	N 9	26.6	12.7	58.4	30	19 02	19 30	20 03	00 29	01 01	02 14	
07	284 54.1	22.5	163 14.9	11.0	9	39.3	12.7	58.5	35	19 15	19 45	20 22	00 30	01 00	02 07	
08	299 53.7	22.4	177 44.9	10.8	9	52.0	12.7	58.5	40	19 30	20 03	20 45	00 31	00 58	01 59	
S 09	314 53.4	22.4	192 14.7	10.7	10	04.7	12.6	58.6	45	19 48	20 26	21 16	00 33	00 56	01 49	
A 10	329 53.1	22.3	206 44.4	10.7	10	17.3	12.6	58.6	S 50	20 11	20 56	22 01	00 34	00 53	01 38	
T 11	344 52.8	22.2	221 14.1	10.5	10	29.9	12.6	58.7	52	20 22	21 11	22 29	00 35	00 52	01 33	
U 12	359 52.5	S23 22.1	235 43.6	10.5	N 10	42.5	12.5	58.7	54	20 34	21 29	23 15	00 36	00 51	01 27	
D 13	14 52.2	22.0	250 13.1	10.4	10	55.0	12.5	58.7	56	20 48	21 51	23 41	00 37	00 50	01 21	
A 14	29 51.9	21.9	264 42.5	10.2	11	07.5	12.4	58.8	S 60	21 05	22 21	23 58	00 38	00 48	01 14	
Y 15	44 51.6	21.9	279 11.7	10.2	11	19.9	12.4	58.8	21 26	21 26	23 11	24 48	00 39	00 46	00 55	
16	59 51.3	21.8	293 40.9	10.1	11	32.3	12.3	58.9	Day	SUN		MOON				
17	74 51.0	21.7	308 10.0	9.9	11	44.6	12.3	58.9	Eqn. of Time	Mer. Pass.	Mer. Pass.	Upper	Lower	Age	Phase	
18	89 50.7	S23 21.6	322 38.9	9.9	N 11	56.9	12.3	58.9	00°	12"	Upper	Lower				
19	104 50.4	21.5	337 07.8	9.8	12	09.2	12.2	59.0	00 45	00 30	11 59	18 58	06 36	09	☉	
20	119 50.0	21.4	351 36.6	9.7	12	21.4	12.1	59.0	00 15	00 00	12 00	19 45	07 21	10		
21	134 49.7	21.3	6 05.3	9.6	12	33.5										

### CONVERSION OF ARC TO TIME

0°-59°			60°-119°			120°-179°			180°-239°			240°-299°			300°-359°			0°00	0°25	0°50	0°75	
h	m	s	h	m	s	h	m	s	h	m	s	h	m	s	h	m	s	m	s			
0	0	00	60	4	00	120	8	00	180	12	00	240	16	00	300	20	00	0	0	00	0	01
1	0	04	61	4	04	121	8	04	181	12	04	241	16	04	301	20	04	1	0	04	0	05
2	0	08	62	4	08	122	8	08	182	12	08	242	16	08	302	20	08	2	0	08	0	09
3	0	12	63	4	12	123	8	12	183	12	12	243	16	12	303	20	12	3	0	12	0	13
4	0	16	64	4	16	124	8	16	184	12	16	244	16	16	304	20	16	4	0	16	0	17
									185	12	20	245	16	20	305	20	20	5	0	20	0	21
									186	12	24	246	16	24	306	20	24	6	0	24	0	25
									187	12	28	247	16	28	307	20	28	7	0	28	0	29
									188	12	32	248	16	32	308	20	32	8	0	32	0	33
									189	12	36	249	16	36	309	20	36	9	0	36	0	37
																		10	0	40	0	41
																		11	0	44	0	45
																		12	0	48	0	49
																		13	0	52	0	53
																		14	0	56	0	57
																		15	1	00	1	01
																		16	1	04	1	05
																		17	1	08	1	09
																		18	1	12	1	13
																		19	1	16	1	17
																					1	18
																					1	19

FIRST AND SECOND ESTIMATE

FIRST ESTIMATE

SECOND ESTIMATE

Figure 7-4. - Extract from the Nautical Almanac.

v or Corr d	v or Corr d	v or Corr d
0-0 0-0	6-0 1-0	12-0 1-9
0-1 0-0	6-1 1-0	12-1 1-9
0-2 0-0	6-2 1-0	12-2 1-9
0-3 0-0	6-3 1-0	12-3 1-9
0-4 0-1	6-4 1-0	12-4 2-0

9<sup>m</sup>

Tab. Dec.	d(+ or -)	S 23-23.9	-0.1
d Corr. (+ or -)			0.0
True Dec.		S 23-23.9	

Figure 7-5. - Increment extract and declination form.

IC	+1.0
Dip (Ht 41')	-6.2
Alt. Corr.	+15.1
Sum	+9.9
hs (at LAN)	40 -10.0'
Ho	40 -19.9'
89-60.0	89-60.0
Ho (-)	40 -19.9'
Zenith Dist.	49 -40.1'
True Dec.	S 23 -23.9'
Latitude	26 -16.2'N

NOTES:

Figure 7-6a. - Sextant corrections and final computation.

DIP			
Ht. of Eye	Corrn	Ht. of Eye	Ht. of Corrn
m		ft.	m
2.4	-2.8	8.0	1.0 - 1.8
2.6	-2.9	8.6	1.5 - 2.2
2.8	-3.0	9.2	2.0 - 2.6
11.8	-6.1	38.7	
12.2	-6.2	40.1	
12.6	-6.3	41.5	70 - 8.1
13.0	-6.4	42.8	75 - 8.4
13.4	-6.5	44.2	80 - 8.7
13.8	-6.6	45.5	85 - 8.9

**ALTITUDE CORRECTION**

OCT.—MAR. SUN			APR.—SEPT.		
App. Alt.	Lower Limb	Upper Limb	App. Alt.	Lower Limb	Upper Limb
9 34	-10.8	-21.5	9 39	-10.6	-21.2
9 45	+10.9	-21.4	9 51	-10.7	-21.1
9 56	+11.0	-21.3	10 03	-10.8	-21.0
10 08	+11.1	-21.2	10 15	-10.9	-20.9
10 20	+11.2	-21.1	10 27	-11.0	-20.8
10 32	+11.3	-21.0	10 39	-11.1	-20.7
10 44	+11.4	-20.9	10 51	-11.2	-20.6
10 56	+11.5	-20.8	11 03	-11.3	-20.5
11 08	+11.6	-20.7	11 15	-11.4	-20.4
11 20	+11.7	-20.6	11 27	-11.5	-20.3
11 32	+11.8	-20.5	11 39	-11.6	-20.2
11 44	+11.9	-20.4	11 51	-11.7	-20.1
11 56	+12.0	-20.3	12 03	-11.8	-20.0
12 08	+12.1	-20.2	12 15	-11.9	-19.9
12 20	+12.2	-20.1	12 27	-12.0	-19.8
12 32	+12.3	-20.0	12 39	-12.1	-19.7
12 44	+12.4	-19.9	12 51	-12.2	-19.6
12 56	+12.5	-19.8	13 03	-12.3	-19.5
13 08	+12.6	-19.7	13 15	-12.4	-19.4
13 20	+12.7	-19.6	13 27	-12.5	-19.3
13 32	+12.8	-19.5	13 39	-12.6	-19.2
13 44	+12.9	-19.4	13 51	-12.7	-19.1
13 56	+13.0	-19.3	14 03	-12.8	-19.0
14 08	+13.1	-19.2	14 15	-12.9	-18.9
14 20	+13.2	-19.1	14 27	-13.0	-18.8
14 32	+13.3	-19.0	14 39	-13.1	-18.7
14 44	+13.4	-18.9	14 51	-13.2	-18.6
14 56	+13.5	-18.8	15 03	-13.3	-18.5
15 08	+13.6	-18.7	15 15	-13.4	-18.4
15 20	+13.7	-18.6	15 27	-13.5	-18.3
15 32	+13.8	-18.5	15 39	-13.6	-18.2
15 44	+13.9	-18.4	15 51	-13.7	-18.1
15 56	+14.0	-18.3	16 03	-13.8	-18.0
16 08	+14.1	-18.2	16 15	-13.9	-17.9
16 20	+14.2	-18.1	16 27	-14.0	-17.8
16 32	+14.3	-18.0	16 39	-14.1	-17.7
16 44	+14.4	-17.9	16 51	-14.2	-17.6
16 56	+14.5	-17.8	17 03	-14.3	-17.5
17 08	+14.6	-17.7	17 15	-14.4	-17.4
17 20	+14.7	-17.6	17 27	-14.5	-17.3
17 32	+14.8	-17.5	17 39	-14.6	-17.2
17 44	+14.9	-17.4	17 51	-14.7	-17.1
17 56	+15.0	-17.3	18 03	-14.8	-17.0
18 08	+15.1	-17.2	18 15	-14.9	-16.9
18 20	+15.2	-17.1	18 27	-15.0	-16.8
18 32	+15.3	-17.0	18 39	-15.1	-16.7
18 44	+15.4	-16.9	18 51	-15.2	-16.6
18 56	+15.5	-16.8	19 03	-15.3	-16.5
19 08	+15.6	-16.7	19 15	-15.4	-16.4
19 20	+15.7	-16.6	19 27	-15.5	-16.3
19 32	+15.8	-16.5	19 39	-15.6	-16.2
19 44	+15.9	-16.4	19 51	-15.7	-16.1
19 56	+16.0	-16.3	20 03	-15.8	-16.0

Figure 7-6b. - Extracts from the Nautical Almanac.

Polaris travels in a diurnal circle of small radius around Pn as shown in the diagram in figure 7-8. The polar distance, or radius of the diurnal circle, is "p." The meridian angle is "t." Point 0 is the intersection of the observer's celestial meridian and the celestial horizon. Ho equals the observed altitude. PnH equals p cos t, and is the correction which must be added or subtracted, depending upon whether Polaris is below or above Pn.

It can readily be seen that the value of the correction will depend upon the meridian angle (t), or the position of the observer's meridian with respect to the hour circle of Polaris. Since the SHA is relatively constant, the correction is also a function of the LHA $\uparrow$ . For Polaris, the Nautical Almanac tabulates corrections based upon the LHA $\uparrow$ , the observer's latitude, and the month of the year. In table ao, the correction is based upon a mean value of SHA and declination of Polaris, and a mean value of 50° north latitude as the position of the observer. Table a1, entered with LHA $\uparrow$  and latitude, corrects for the difference between actual latitude

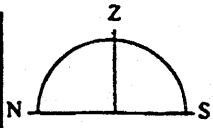
LATITUDE AT L.A.N.	
FIRST ESTIMATE	
Date	25 DEC 82
DR Latitude	26°-14.1'N
DR $\lambda$	77°-15.2'W
Central Meridian	75°-00.0'W
d $\lambda$ (arc)	2°-15.2'W
d $\lambda$ (time)	9m 1s
Mer. Pass. (LMT)	12-00-00
ZT (est) 1st	12-09-01
SECOND ESTIMATE	
DR $\lambda$	77°-19.0'W
Central Meridian	75°-00.0'W
d $\lambda$ (arc)	2°-19.0'W
d $\lambda$ (time)	9m 16s
Mer. Pass. (LMT)	12-00-00
ZT (est) 2nd	12-09-16
ZT (actual)	12-09-16
ZD (W+, E-)	+5
GMT	17-09-16
Date (GMT)	25 DEC 82
Tab. Dec. d(+ or -)	S23-23.9-0.1
d Corr. (+ or -)	0.0
True Dec.	S23°-23.9'
IC	+1.0
Dip (Ht 41')	-6.2
Sum	-5.2
hs (at LAN)	40°-10.0'
ha	40°-04.8'
Alt. Corr.	+15.1
89-60.0	89-60.0
Ho	40°-19.9'
Zenith Dist.	49°-40.1'N
True Dec.	S23°-23.9'
Latitude	26°-16.2'N

NOTES:

Figure 7-7. - Completed LAN Sight Form.

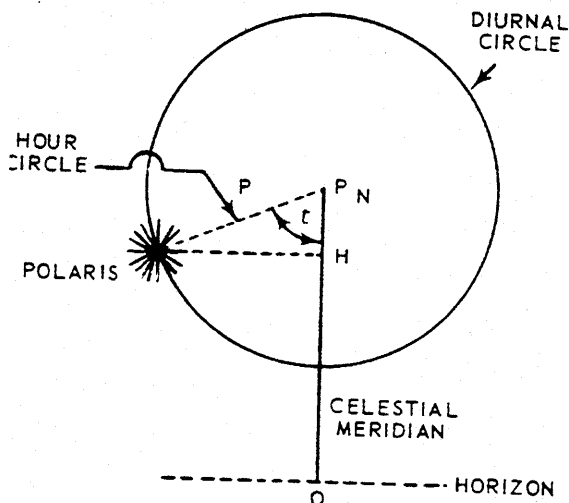

Figure 7-8. - Polaris.

and the mean. Table a2, entered with LHA and the month of the year, corrects for variation in the position of Polaris from its selected mean position. All corrections from these tables contain constants, which make the corrections positive, and which when added together, equal 1 degree. Thus, the correction is added to the  $H_o$ , and 1 degree is subtracted to determine latitude.

In summary, latitude may be ascertained in the Northern Hemisphere by observing the  $H_s$  of Polaris, at a known time. From the time, and the DR or estimated longitude, compute the LHA of Aries. Correct  $H_s$  to  $H_o$ , and using the LHA, approximate latitude, and date, determine corrections from Polaris tables a0, a1, and a2. Add total correction to  $H_o$ , and subtract 1 degree to obtain latitude.

### COMPUTING LATITUDE BY POLARIS USING THE NAUTICAL ALMANAC

Polaris was observed at zone time 18-18-35, at which time the DR position of the observer was Lat.  $67^{\circ}-25.0'N$ , Long.  $116^{\circ}-35.0'W$ . The sextant index correction (IC) is  $+1.5'$  and the height of eye is 42 feet.

After entering this information on the sight form, the LHA of Aries is determined. To do this, the GHA of Aries for the time of the observation is first obtained by combining the tabulated GHA of Aries on the daily pages with the proper GHA increment; in this case, the GHA of Aries is  $136^{\circ}-47.4'$ .

Since the longitude is west and is less than the GHA of Aries in this case, the exact LHA of Aries is found by subtracting the DR longitude from the GHA of Aries. The form now appears as in figure 7-10.

After determining the exact LHA of Aries, the IC and dip corrections are summed up and applied to the sextant altitude  $h_s$  to obtain the apparent altitude  $h_a$  of  $68^{\circ}-16.5'$ . The refraction correction for this altitude is  $-0.4'$ . After entering this value on the form, the Polaris Tables shown in figure 7-9 are entered to find the three parts of the Polaris correction. The entering argument for the tables is the LHA of Aries,  $20^{\circ}-12.4'$ . The appropriate column is, therefore, the third one, headed  $20^{\circ}-29^{\circ}$ . To find the a0 part, the upper third of the table containing corrections for each integral degree of LHA from  $20^{\circ}$  to  $30^{\circ}$  is used, with interpolation, if necessary, to arrive at the a0 correction corresponding to LHA of Aries  $20^{\circ}-12.4'$ . In this case, the tabulated a0 value for LHA of Aries  $20^{\circ}$  is  $+11.6'$ . After recording this  $+11.6'$  a0 correction on the form, we proceed to the middle third of the table, in the same column, to obtain the a1 part. The entering argument in the left margin is the tabulated latitude closest to the DR latitude, or  $68^{\circ}$  in this case. The corresponding a1 value is  $+0.6'$  which is recorded on the form. The a2 part is obtained from the lower third of the table, staying in the same column, opposite the month of observation; January in this case. It is  $+0.7'$ . As a final step in finding the total correction to be applied to  $h_a$ , a0, a1, and a2 are added algebraically with the negative refraction correction and the required  $-60.0'$  constant. In this example, the addition yields a total correction of  $-47.5'$ . Applying this correction to  $h_a$  yields the desired latitude line,  $67^{\circ}-29.0'N$ . The completed sight form is shown in figure 7-11.

**POLARIS (POLE STAR) TABLES, 1983**  
FOR DETERMINING LATITUDE FROM SEXTANT ALTITUDE AND FOR AZIMUTH

L.H.A. ARIES	0°- 9°	10°- 19°	20°- 29°	30°- 39°	40°- 49°	50°- 59°	60°- 69°	70°- 79°	80°- 89°	90°- 99°	100°- 109°	110°- 119°
°	<i>a</i> <sub>0</sub>	<i>a</i> <sub>0</sub>	<i>a</i> <sub>0</sub>	<i>a</i> <sub>0</sub>	<i>a</i> <sub>0</sub>	<i>a</i> <sub>0</sub>	<i>a</i> <sub>0</sub>	<i>a</i> <sub>0</sub>	<i>a</i> <sub>0</sub>	<i>a</i> <sub>0</sub>	<i>a</i> <sub>0</sub>	<i>a</i> <sub>0</sub>
0	18.5	14.4	11.6	10.3	10.5	12.2	15.3	19.8	25.5	32.1	39.6	47.7
1	18.0	14.0	11.4	10.3	10.6	12.4	15.7	20.3	26.1	32.9	40.4	48.5
2	17.5	13.7	11.2	10.2	10.7	12.7	16.1	20.8	26.7	33.6	41.2	49.4
3	17.1	13.4	11.1	10.2	10.9	13.0	16.5	21.4	27.4	34.3	42.0	50.2
4	16.7	13.1	10.9	10.2	11.0	13.3	17.0	21.9	28.0	35.1	42.8	51.0
5	16.3	12.8	10.8	10.2	11.2	13.6	17.4	22.5	28.7	35.8	43.6	51.9
6	15.8	12.5	10.6	10.2	11.3	13.9	17.9	23.1	29.4	36.6	44.4	52.7
7	15.5	12.3	10.5	10.3	11.5	14.2	18.3	23.6	30.0	37.3	45.2	53.6
8	15.1	12.0	10.4	10.3	11.7	14.6	18.8	24.2	30.7	38.1	46.1	54.4
9	14.7	11.8	10.4	10.4	12.0	14.9	19.3	24.8	31.4	38.9	46.9	55.3
10	14.4	11.6	10.3	10.5	12.2	15.3	19.8	25.5	32.1	39.6	47.7	56.1
Lat.	<i>a</i> <sub>1</sub>	<i>a</i> <sub>1</sub>	<i>a</i> <sub>1</sub>	<i>a</i> <sub>1</sub>	<i>a</i> <sub>1</sub>	<i>a</i> <sub>1</sub>	<i>a</i> <sub>1</sub>	<i>a</i> <sub>1</sub>	<i>a</i> <sub>1</sub>	<i>a</i> <sub>1</sub>	<i>a</i> <sub>1</sub>	<i>a</i> <sub>1</sub>
°	.	.	.	.	.	.	.	.	.	.	.	.
0	0.5	0.6	0.6	0.6	0.6	0.5	0.5	0.4	0.4	0.3	0.2	0.2
10	.5	.6	.6	.6	.6	.6	.5	.4	.4	.3	.3	.3
20	.5	.6	.6	.6	.6	.6	.5	.5	.4	.4	.3	.3
30	.6	.6	.6	.6	.6	.6	.5	.5	.5	.4	.4	.4
40	0.6	0.6	0.6	0.6	0.6	0.6	0.6	0.5	0.5	0.5	0.5	0.5
45	.6	.6	.6	.6	.6	.6	.6	.6	.6	.5	.5	.5
50	.6	.6	.6	.6	.6	.6	.6	.6	.6	.6	.6	.6
55	.6	.6	.6	.6	.6	.6	.6	.6	.6	.7	.7	.7
60	.6	.6	.6	.6	.6	.6	.7	.7	.7	.7	.8	.8
62	0.7	0.6	0.6	0.6	0.6	0.6	0.7	0.7	0.7	0.8	0.8	0.8
64	.7	.6	.6	.6	.6	.6	.7	.7	.8	.8	.9	.9
66	.7	.6	.6	.6	.6	.6	.7	.8	.8	.9	.9	1.0
68	0.7	0.6	0.6	0.6	0.6	0.7	0.7	0.8	0.9	0.9	1.0	1.0
Month	<i>a</i> <sub>2</sub>	<i>a</i> <sub>2</sub>	<i>a</i> <sub>2</sub>	<i>a</i> <sub>2</sub>	<i>a</i> <sub>2</sub>	<i>a</i> <sub>2</sub>	<i>a</i> <sub>2</sub>	<i>a</i> <sub>2</sub>	<i>a</i> <sub>2</sub>	<i>a</i> <sub>2</sub>	<i>a</i> <sub>2</sub>	<i>a</i> <sub>2</sub>
°	.	.	.	.	.	.	.	.	.	.	.	.
Jan.	0.7	0.7	0.7	0.7	0.7	0.7	0.7	0.7	0.7	0.7	0.6	0.6
Feb.	.6	.6	.7	.7	.7	.7	.8	.8	.8	.8	.8	.8
Mar.	.5	.5	.6	.6	.7	.7	.8	.8	.8	.9	.9	.9
Apr.	0.3	.4	.4	.5	.5	.6	.7	.7	.8	.8	.9	.9
May	.2	.2	.3	.3	.4	.5	.5	.6	.7	.8	.8	.9
June	.2	.2	.2	.2	.3	.3	.4	.5	.5	.6	.7	.8
July	0.2	0.2	0.2	0.2	0.2	0.2	0.3	0.3	0.4	0.5	0.5	0.6
Aug.	.3	.3	.3	.2	.2	.2	.2	.3	.3	.3	.4	.4
Sept.	.5	.5	.4	.4	.3	.3	.3	.3	.3	.3	.3	.3
Oct.	0.7	0.6	0.6	0.5	0.5	0.4	0.4	0.3	0.3	0.3	0.3	0.3
Nov.	0.9	0.8	.8	.7	.7	.6	.5	.5	.4	.4	.3	.3
Dec.	1.0	1.0	0.9	0.9	0.8	0.8	0.7	0.6	0.6	0.5	0.4	0.4
Lat.	AZIMUTH											
°	.	.	.	.	.	.	.	.	.	.	.	.
0	0.4	0.3	0.1	0.0	359.8	359.7	359.6	359.5	359.4	359.3	359.2	359.2
20	0.4	0.3	0.1	0.0	359.8	359.7	359.5	359.4	359.3	359.2	359.2	359.1
40	0.5	0.3	0.2	0.0	359.8	359.6	359.4	359.3	359.2	359.1	359.0	359.0
50	0.6	0.4	0.2	0.0	359.7	359.5	359.3	359.2	359.0	358.9	358.8	358.8
55	0.7	0.5	0.2	0.0	359.7	359.5	359.3	359.1	358.9	358.7	358.7	358.6
60	0.8	0.5	0.3	0.0	359.7	359.4	359.1	358.9	358.7	358.6	358.5	358.4
65	0.9	0.6	0.3	0.0	359.6	359.3	359.0	358.7	358.5	358.3	358.2	358.1

Latitude = Apparent altitude (corrected for refraction) -  $i^\circ + a_0 + a_1 + a_2$

The table is entered with L.H.A. Aries to determine the column to be used; each column refers to a range of  $10^\circ$ .  $a_0$  is taken, with mental interpolation, from the upper table with the units of L.H.A. Aries in degrees as argument;  $a_1, a_2$  are taken, without interpolation, from the second and third tables with arguments latitude and month respectively.  $a_0, a_1, a_2$  are always positive. The final table gives the azimuth of *Polaris*.

Figure 7-9. - Extract from the Nautical Almanac.

LATITUDE BY POLARIS	
DR Lat.	67°-25.0'N
DR Long.	116°-35.0'W
Date	2 JAN 83
ZT	18-18-35
ZD (W+, E-)	+8 1
GMT	02-18-35
Date (GMT)	3 JAN 83
Tab. GHA T	132°-07.9'
Incr'm't T	4°-39.5'
Total GHA T	136°-47.4'
±360 if needed	
DR λ (-W, +E)	116°-35.0'W
LHA T (Exact)	20°-12.4'

Figure 7-10. - Exact LHA of Aries.

LATITUDE BY POLARIS	
DR Lat.	67°-25.0'N
DR Long.	116°-35.0'W
Date	2 JAN 83
ZT	18-18-35
ZD (W+, E-)	+8 1
GMT	02-18-35
Date (GMT)	3 JAN 83
Tab. GHA T	132°-07.9'
Incr'm't T	4°-39.5'
Total GHA T	136°-47.4'
±360 if needed	
DR λ (-W, +E)	116°-35.0'W
LHA T (Exact)	20°-12.4'
IC	+1.5
Dip (Ht. 42')	-6.3
Sum	-4.8
hs	68°-21.3'
ha	68°-16.5'
Refr. Corr. (ALT CORR TABLE)	-0.4
TB (ha < 10°)	+ -
a <sub>0</sub>	+11.6
a <sub>1</sub>	+0.6
a <sub>2</sub>	+0.7
Add'n'l	-60.0
Sub Total	+12.9 - 60.4
Total Corr. to ha (±)	-47.5
ha	68°-16.5'
Latitude	67°-29.0'N

Figure 7-11. - Completed sight form for latitude by Polaris.

## SELF-QUIZ #7

1. The oldest and most commonly used method of determining meridian altitude of the sun is the \_\_\_\_\_ method.

- A. instant of transit
- B. following to maximum altitude
- C. numerous sight
- D. approximate time of transit

2. The moment when the apparent sun crosses the upper branch of the observer's celestial meridian is referred to as \_\_\_\_\_.

- A. LHA
- B. GHA
- C. LAN
- D. GAN

3. The three parts of the Polaris correction are all based on the exact \_\_\_\_\_ of Aries.

- A. LHA
- B. GHA
- C. SHA
- D. GCA

4. In practice, the latitude line is normally obtained by observing the sun or \_\_\_\_\_.

- A. Rigel
- B. Pollux
- C. Procyon
- D. Polaris

5. In the Polaris Tables in the Nautical Almanac, there are three corrections. They are for LHA of Aries, latitude, and the \_\_\_\_\_.

- A. day
- B. week
- C. month
- D. year

## ANSWERS TO SELF-QUIZ #7

QUESTION	ANSWER	REFERENCE
1	B	7-2
2	C	7-1
3	A	7-8
4	D	7-1
5	C	7-10



## ALTITUDE-INTERCEPT METHOD

Reading Assignment: 8  
Page 8-1 through 8-5

### OBJECTIVES

To successfully complete this assignment, you must study the text and master the following objectives:

1. Demonstrate the altitude-intercept method of solving the navigational triangle.
2. Demonstrate the altitude-intercept method of plotting a celestial line of position.

### INTRODUCTION

In the advancement of the practice of celestial navigation, perhaps the milestone following the appearance of Harrison's chronometer was the discovery of a solution for a celestial line of position. The discovery was made by an American shipmaster, Captain Thomas A. Sumner, in 1837. From the observation of an altitude of the sun, three computations for longitude were made using a different latitude in each because of uncertainty of latitude. After plotting three positions from these computations, it was noted that the three could be connected by a straight line which was correctly assumed to be a locus or line of position. Subsequently, a landfall gave further evidence of the correctness of this assumption. Since Sumner's discovery, solution for a use of such a line of position, has been the essence of celestial navigation.

Unfortunately, to obtain a "Sumner's line," multiple computations are required. However, in 1875, the computation was simplified by a procedure introduced by Commander Marcq de St. Hilaire, French Navy. By the St. Hilaire or "altitude intercept" method, the altitude and azimuth of a celestial body are computed for an approximate or assumed position of the ship at a given time of observation. By comparison of the observed altitude and the computed altitude, the difference, known as "intercept," is determined in minutes of arc. A line is drawn through the assumed position

from which the computed altitude was obtained, in the direction of the azimuth. If the observed altitude is greater than the computed, the observer is nearer the body, and conversely, if the computed altitude is greater than the observed, the observer is farther away. Accordingly, the intercept in minutes of arc is directly converted to nautical miles and is measured from the assumed position along the azimuth line, toward or away from the celestial body, as appropriate. At the point thus established, a line of position is drawn, at right angles to the azimuth line. This celestial line of position, although a straight line, is representative of a short arc, taken from a circle of equal altitude drawn about the geographical position (GP) of the observed body. (See figures 8-1 and 8-2.) Mathematically, a Sumner's line is actually a chord of such a circle; the Marcq de St. Hilaire line is a tangent.

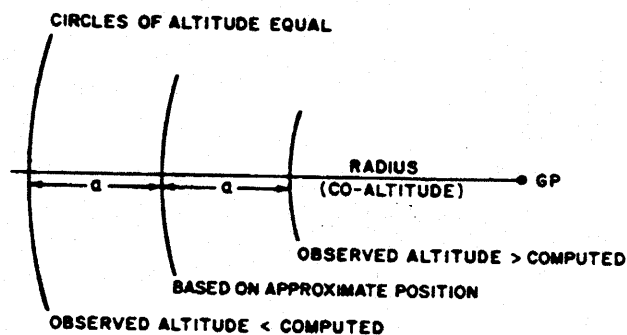
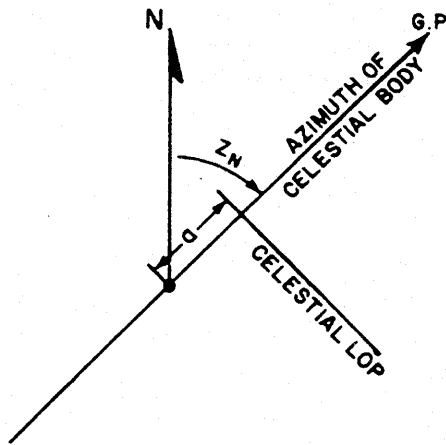
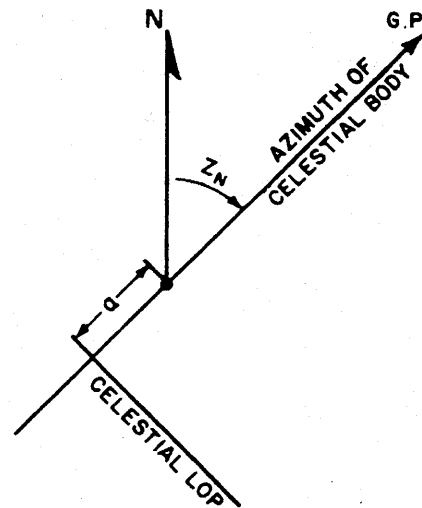

Figure 8-1. - Relationship of circles of equal altitude and intercept "a."



ALTITUDE INTERCEPT "A" IS "TOWARD", AS ALTITUDE OBSERVED IS GREATER THAN COMPUTED.



ALTITUDE INTERCEPT "A" IS "AWAY", AS ALTITUDE OBSERVED IS LESS THAN COMPUTED.

Figure 8-2. - Plot of LOP.

The altitude intercept method as introduced by Commander St. Hilaire was widely adopted. For solution of the astronomical or navigational triangle for computed altitude and azimuth, the use of a cosine-haversine formula was adopted, a haversine of an angle being equal to one half the quantity of one minus the cosine of such angle. Thus, the solution of the triangle, while somewhat easier, still required resorting to spherical trigonometry. However, the solution was further simplified by Ogura of Japan, among others, and in the 1930's several new methods were introduced, making use of tables of solutions for spherical triangles of various dimensions.

### ALTITUDE-INTERCEPT

The altitude of a celestial body may be measured. After appropriate corrections are applied, this is called observed altitude ( $H_o$ ). For the instant of observation, the altitude and azimuth at some convenient assumed position (AP) near the actual position of the observer are determined by calculation or equivalent process. The difference between this computed altitude ( $H_c$ ) and  $H_o$  is the altitude intercept ( $a$ ), sometimes called altitude difference. Since  $a$  is the difference in altitude at the assumed and actual

positions, it is also the difference in zenith distance, and therefore, the difference in radii of the circles of equal altitude at the two places. The position having the greater altitude is on the circle of smaller radius, and hence is closer to the GP of the body. In figure 8-3 the AP is shown on the inner circle.

The line of position can be plotted by using the altitude intercept portion of the information of figure 8-3, as shown in figure 8-4. First, the AP is plotted. The circle of equal altitude through this position is not needed, and not plotted. From the AP the azimuth line is measured toward or away from the GP as appropriate, and the altitude intercept is measured along this line. At the point thus located, a line is drawn perpendicular to the azimuth line. For several miles on each side of the azimuth line, this perpendicular can be considered part of the circle of position through the observer, as shown in figure 8-3. This perpendicular is the line of position. It is labeled with the time of observation above the line, and the name of the celestial body below the line, as shown in figure 8-4.

For neatness of the plot, the azimuth line should not be extended beyond the line of

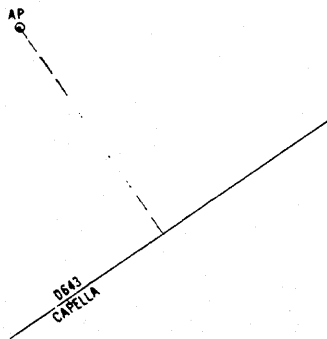

Figure 8-3. - The basis for the line of position from a celestial observation.

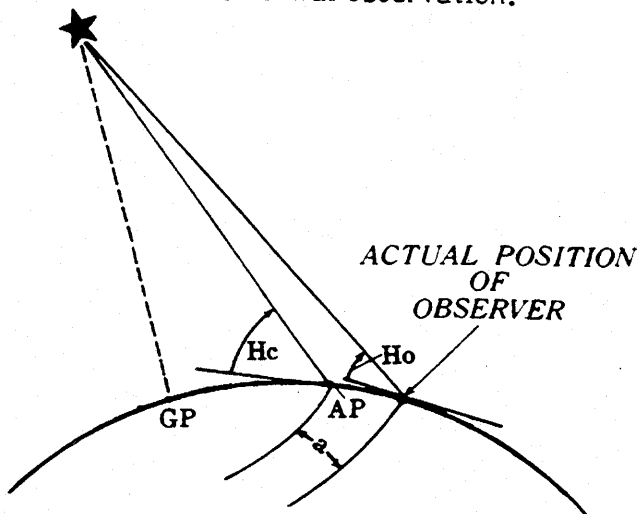

Figure 8-4. - A line of position from observation of the star Capella at 0643.

position for the AP, unless it is extended a short distance in the direction of the body, and the symbol of the body observed is shown to indicate whether a "toward" or "away" observation. It is necessary to remember the direction of the intercept. From the description given, the phrase "Computed Greater Away" can be derived. A useful memory aid for CGA is "Coast Guard Academy." Another helpful acronym is "HoMoTo" for "Ho More Toward."

Some navigators may omit the azimuth line, showing only the AP and line of position, and using a straightedge as a guide for the dividers in measuring the altitude difference. This is good practice because it reduces the number of lines on the plotting sheet and minimizes the possibility of making an error. However until one gains confidence in plotting lines of position, it is desirable to show the azimuth line.

For plotting a line of position from a celestial observation, then only the assumed position, altitude intercept (either toward or away), and azimuth are needed.

The assumed position is chosen somewhat arbitrarily. It may be the dead reckoning position, an estimated position, or any chosen position nearby. Most commonly, however, the assumed latitude ( $aL$ ) is taken as the nearest whole degree of latitude to the DR or EP; and the assumed longitude ( $a2$ ) is selected so that the local hour angle is whole degree. The location of the line of position is independent of the location of the AP, assuming only that the altitude intercept is measured from the AP used for determining  $H_c$ . That is, each AP has its own altitude intercept, depending upon its distance from the line of position.

The altitude intercept, the numerical difference between  $H_c$  and  $H_o$ , is customarily expressed in nautical miles (minutes of arc), and labeled T or A to indicate whether the line of position is toward or away from the GP, as measured from the AP:

$H_c$ $37^{\circ}51'.6$	$H_c$ $61^{\circ}57'.3$
$H_o$ $37^{\circ}43'.9$	$H_o$ $62^{\circ}12'.7$
$a$ $7.7A$	$a$ $15.4T$

The azimuth is customarily determined by computation or table at the time of determining  $H_c$ .

Given: The 0635 DR position of your ship is Lat. 36 N., Long. 120W. Between 0600 and 0700 you course is  $000^{\circ}$  (T), speed 20 knots. At morning twilight, you observe available stars and through computations obtain the following data:

<u>Time</u>	<u>Body</u>	<u>a Lat</u>	<u>a Long</u>	<u>Advance*</u>	<u>Zn</u>	<u>a</u>
0610	Vega	36N	120-36W	8.3	025	6.0T
0620	Peacock	36N	119-55W	5.0	100	24.0A
0635	Canopus	36N	120-20W	Base	330	10.3T

\* Computation of advance is necessary because the stars were not observed simultaneously, and to fix our position, we must use a common time (preferable method is to choose as a common time the time of the last sight). To use a common time we adjust our AP's, except in the case of the AP of the star observed at the common time (in this problem, Canopus, which is considered the base star). Advance is computed as follows:

<u>Body</u>	<u>Time</u>	<u>Speed</u>	<u>Distance of Advance</u>
Vega	0635-0610 = 25 min.	20 kts.	8.3 mi.
Peacock	0635-0620 = 15 min.	20 kts.	5.0 mi.

Required: Plot the 0635 fix.

- Solution:
- Label plotting sheet with center meridian as 120 W.
  - Plot 0635 DR.
  - Plot AP's of Vega, Peacock, and Canopus, using assumed latitude and longitude. Label AP's.
  - Advance AP Vega in direction  $000^{\circ}$  a distance of 8.3 mi. Advance AP Peacock in direction  $000^{\circ}$  a distance of 5.0 mi. Erase old AP's of Vega and Peacock, if desired.
  - Plot azimuths, intercepts, and LOP's. Label LOP's and fix.

Note: If the reason for advancement of earlier AP's is not clear, then the following exercise should be completed:

- Plot AP's of Vega, Peacock, and Canopus using assumed latitude and longitude, Label AP's.
- Plot azimuths, intercepts, and LOP's. Label LOP's.
- Advance LOP Vega and LOP Peacock in direction  $000^{\circ}$ , in accordance with the procedure in plotting running fixes in piloting.
- Check latitude and longitude of fix against coordinates obtained in previous method of solution.

ANSWER: Lat.  $36^{\circ}-10.0'$  N; Long.  $120^{\circ}-21.0'$  W.

The above information is a sample star plotting problem using the azimuth and altitude intercept of Vega, Peacock, and Canopus.

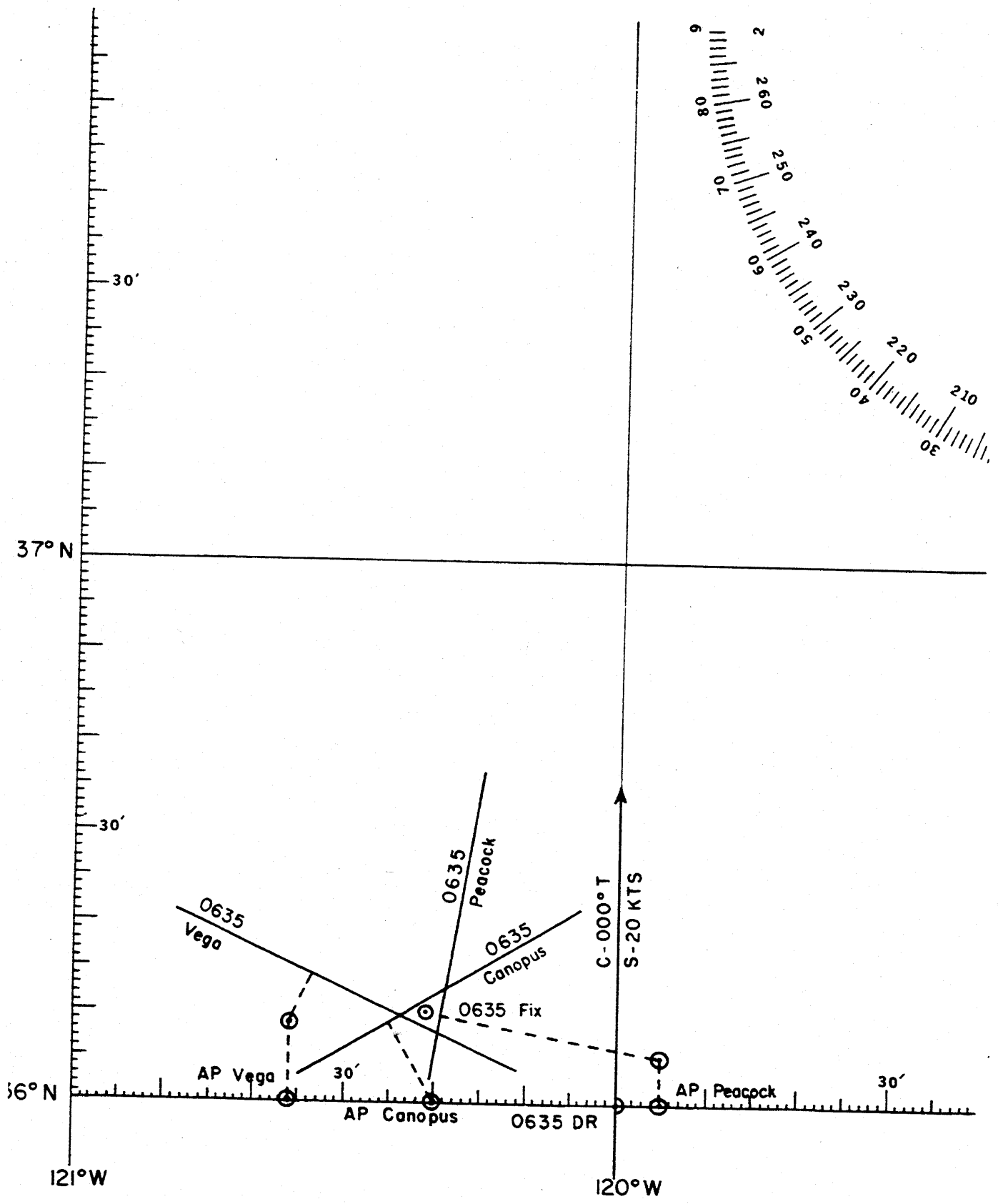

Figure 8-5. - Star fix using the information from page 8-4 and a section of a position plotting sheet.

### SELF-QUIZ #8

1. To determine the position of the celestial LOP, the computed altitude is compared with \_\_\_\_\_.

- A. Ho
- B. Ht
- C. Hs
- D. Hb

2. If your Hc is  $40^{\circ}42.7'$  and your Ho is  $40^{\circ}38.3'$ . What is your altitude intercept?

- A. 4.4 toward the GP
- B. 4.4 away from the GP
- C. 4.4 toward the LOP
- D. 4.4 away from the LOP

3. To plot a line of position from a celestial observation, you need only the position, altitude intercept, and \_\_\_\_\_.

- A. GP
- B. latitude
- C. azimuth
- D. declination

## ANSWERS TO SELF-QUIZ #8

QUESTION	ANSWER	REFERENCE
1	A	8-2
2	B	8-3
3	C	8-3

## CELESTIAL OBSERVATIONS

Reading Assignment: 9  
Pages 9-1 through 9-8

### OBJECTIVES

To successfully complete this assignment, you must study the text and master the following objectives:

1. Determine the GHA and declination of the following bodies:
  - a. stars
  - b. planets
  - c. the moon
  - d. the sun
2. Describe how to compute the LHA of a celestial body.
3. Explain how to compute the complete solution for a celestial observation using the Nautical Almanac and the Sight Reduction Tables for Marine Navigation, Pub. No. 229.

### INTRODUCTION

The eight preceding assignments have dealt with all the aspects needed for determining a line of position from an observation of a celestial body. This assignment will present the complete solution using the Nautical Almanac and the Sight Reduction Tables for Marine Navigation, Pub No. 229. The steps involved will be covered in the order in which they are taken.

### PUB. 229 METHOD

Pub. 229 Sight Reduction Tables for Marine Navigation is a set of six volumes of precalculated solutions for the computed altitude (Hc) and the azimuth angle (Z) of the navigational triangle. Each volume covers a 15 degree band of latitude with a 1° overlap occurring between volumes.

Entering arguments for the tables are local hour angle (LHA), assumed latitude, and declination expressed in whole degrees. Values of Hc and Z are tabulated for each whole degree of each of the entering arguments. Tables inside the front and back covers of each volume allow for interpolation

of Hc and Z for the exact declination. No interpolation is necessary for LHA or assumed latitude because intercept distance corrects for the whole LHA and latitude figures.

Each volume contains two sets of tabulation for whole degrees of LHA between 0° and 360°. The front half is for the first eight degrees of latitude covered by that volume, and the second half is for the remaining eight degrees of latitude. The values of LHA are at the top and bottom of each page. The eight degrees of latitude form the horizontal argument and the declination is the vertical argument.

Instructions at the top and bottom of each page indicate whether the tabulations on that page are for the latitude which is the same or contrary to the declination.

### WORKING SIGHTS WITH PUB. 229

To work a sight with Pub. 229, you enter the tables by selecting the proper volume and turning to the page with the appropriate LHA.



Using the assumed latitude for the nearest whole degree of declination less than the exact declination extract the tabulated values for Hc and Z.

You then determine the exact value of Hc corresponding to the time of observation by interpolation.

The entering arguments for the interpolation tables are the declination increment (Dec. Inc.) - the remaining minutes and tenths of the exact declination - and the altitude difference (d) between the two tabulated Hc's bracketing the exact declination. The value of d between successive tabulated Hc's is precalculated and appears in the center of each column of tabulations. If Hc decreases in value with decreasing declination the sign of the altitude difference is negative. If Hc increases with increasing declination the sign is positive.

The correction is extracted from the interpolation tables in two increments, one for the tens of minutes and the other for the remaining units and tenths. Adding the two parts together gives the total correction. The total correction is added algebraically to the tabulated Hc to obtain the final computed altitude. In some instances a third increment is necessary. It is called the "double second difference" correction (DS corr.). When the DS correction is necessary, it will be indicated in the tables by the d value being printed in italic type followed by a dot.

To find a double second difference correction, the difference between the two d values directly above and directly below the d value corresponding to the whole portion of the actual declination is mentally computed. Using the double second difference as an entering argument, the right-hand side of the interpolation table is used to find the correction. There are several complete DS interpolation sections on each page; opposite the original declination increment. If a DS correction is necessary, it is always added to the total of the tens and units increments to form the total interpolation correction. The total correction is applied to the Hc to obtain the final computed Hc.

To find the intercept distance (a), this final Hc is compared to the observed altitude (Ho). If the computed altitude Hc is greater than observed altitude Ho the intercept is AWAY from the direction of the GP of the body.

To find the true azimuth of the GP from the AP, the azimuth angle Z must be determined. To compute the value for Z, you'll need to interpolate between the values of Z tabulated in Pub. 229 for the whole degrees of declination bracketing the true declination in the same latitude column used previously. The difference between successive tabulated azimuth angles is usually small and the interpolation is done mentally. The value of the azimuth angle is then labeled. If the assumed latitude is in the Northern Hemisphere, the prefix is N. If the body is east of the observer the suffix is E.

The final step to convert azimuth angle to true azimuth Zn of the body. The easiest method is to use the conversion formulas printed on each page of Pub. 229.

LHA greater than  $180^{\circ}$       Zn =  
N. Lat.

LHA less than  $180^{\circ}$  Zn =  $360^{\circ}$

LHA greater than  $180^{\circ}$  Zn =  $180^{\circ}$   
S. Lat.

LHA less than  $180^{\circ}$  Zn =  $180^{\circ}$

### Steps in Working a Sight

Basically, there are eight steps in working a sight. We will take a hypothetical situation and work out the celestial observation step by step. A form should be followed when working out a sight, so that there will be less chance for leaving out any pertinent information.

Step 1. Note the body observed, zone time (ZT), zone description (ZD), and date. Check the watch error (WE) and the index error (IC). Observe the sextant altitude (hs). Note DR latitude and longitude.

Step 2. Convert the watch time to GMT and Greenwich date.

Step 3. Enter the appropriate daily page of the Nautical Almanac and obtain the GHA and declination of the body at the whole

hours and the "d" value (note the sign + or -by inspection). Obtain the SHA or v correction, if necessary. From the appropriate tables in the yellow pages, obtain the the increments of GHA for minutes and seconds and the correction to declination for the "d" value. Applying these values to those obtained from the daily page, you obtain the GHA and declination of the body at the time of observation. (See figure 9-2.)

**Step 4.** From the inside front cover, obtain the correction for Dip (height of eye). Combine the IC and Dip corrections and apply to hs and obtain apparent altitude (ha). The Nautical Almanac has ha as the entering argument for the altitude correction which is on the inside front cover. Applying the altitude correction to ha, you obtain the true observed altitude (Ho). (See figure 9-2.)

**Step 5.** Select an assumed position, based on your DR position. The assumed latitude (aL) is in whole degrees and is usually the same as DR latitude. The assumed longitude (a ) is selected so that when applied to GHA the resulting LHA is in whole degrees. When selecting the aL and a , they must be within 30' of your DR.

**Step 6.** Enter Pub. 229 with LHA, aL, and declination. Extract tabulated computed altitude (Hc), azimuth (Z), and declination difference (d) (note sign + or - by inspection). Turn to the appropriate interpolation tables and obtain the correction to be applied to Hc tabulated to obtain Hc. (See figure 9-3.)

**Step 7.** Determine the true azimuth (Zn) as described previously and plot the azimuth line through the AP.

**Step 8.** Determine the difference between Hc and Ho, measure it toward or away from the observed body, depending on the result of your application of the computed greater away formula, and draw a perpendicular to the azimuth line. The perpendicular is the line of position.

Now that you know the steps, let's follow through the steps of a sun sight:

On 19 September 1983, the 1045 DR position of a vessel is Latitude 42°-00'N, Longitude 68°-30'W. About this time, the

navigator observed the lower limb of the sun from a height of eye of 30 feet with a marine sextant having an index error of -1'.0 (IC +1'.0). The comparing watch reads 10-47-13 AM at the time of observation and the watch error was 10s fast on ZT. The sextant altitude is 48°-21'.3. The number in parentheses indicates the step in which that particular information is recorded. The complete solution is shown in figure 9-1.

(1) Body	Sun (44)
(1) IC	+ 1.0
(.) Dip(Hr 30 ft)	- 5.3
(4) Sun	- 4.3
(1) hs	48° 21'.3
(4) ha	48° 17'.0
(4) Alt. Corr.	+ 15'.1
(4) Add'l.	
(4) H.P. ( )	
(4) Corr. to ha	+ 15'.1
(4) Ho (Obs. Alt.)	48° 32'.1
(1) Date	Sept. 19, 1983
(1) DR Lat	42° 00'.0N
(1) DR Long	68° 30'.0W
(1) Obs. Time	10 47 13
(1) WE(S-,F-)	- 10
(1) ZT	10 47 03
(1) ZD(W+,E-)	+5
(2) GMT	15 47 03
(2) Date (GMT)	Sept. 19, 1983
(3) Tab GHA	46° 31'.6
(3) GHA Incr/mt.	11° 45'.8
(3) SHA or v Corr.	
(3) GHA	58° 17'.4
(3) ± 360 if needed	418° 17'.4
(5) a L (-W,+E)	68° 17'.4
(5) LHA	350° 00'.0
(3) Tab Dec	d -1.0 N 1° 33'.0
(3) d Corr. (+ or -)	- 0'.8
(3) True Dec	N 1° 32'.2
(5) a Lat (N or S)	42° 00'.0N
(3) Dec Inc	(Mid+ 32'.2 + 58.9
(6) Hc (Tab. Alt.)	48° 01'.4
(6) tens 50 DS Diff.	+ 26'.8
(6) units 8,9 DS Corr.	+ 4'.8
(6) Tot. Corr. (+ or -)	+ 31'.6
(6) Hc (Comp. Alt.)	48° 33'.0
(4) Ho (Obs. Alt.)	48° 32'.1
(8) a (Intercept)	.9 A
(6) =	N 165 E
(7) Zn (°T)	165°T

Figure 9-1. - Completed Solution

1983 SEPTEMBER 19, 20, 21 (MON., TUES., WED.)

G.M.T.	SUN	
	G.H.A.	Dec.
19 00	181 28.3 N	1 47.5
01	196 28.5	46.5
02	211 28.7	45.6
03	226 28.9	44.6
04	241 29.1	43.6
05	256 29.4	42.7
06	271 29.6 N	1 41.7
07	286 29.8	40.7
08	301 30.0	39.7
M 09	316 30.3	38.8
10	331 30.5	37.8
O 11	346 30.7	36.8
N 12	1 30.9 N	1 35.9
D 13	16 31.2	34.9
A 14	31 31.4	33.9
15	46 31.6	33.0
16	61 31.8	32.0
17	76 32.0	31.0
18	91 32.3 N	1 30.1
19	106 32.5	29.1
20	121 32.7	28.1
21	136 32.9	27.1
22	151 33.2	26.2
23	166 33.4	25.2
20 00	181 33.6 N	1 24.2
01	196 33.8	23.3
02	211 34.1	22.3
03	226 34.3	21.3
04	241 34.5	20.4
05	256 34.7	19.4
06	271 34.9 N	1 18.4
07	286 35.2	17.4
08	301 35.4	16.5
09	316 35.6	15.5
10	331 35.8	14.5
11	346 36.1	13.6
12	1 36.3 N	1 12.6
13	16 36.5	11.6
14	31 36.7	10.7
15	46 37.0	09.7
16	61 37.2	08.7
17	76 37.4	07.7
18	91 37.6 N	1 06.8
19	106 37.8	05.8
20	121 38.1	04.8
21	136 38.3	03.9
22	151 38.5	02.9
23	166 38.7	01.9
21 00	181 39.0 N	1 00.9
01	196 39.2	1 00.0
02	211 39.4	0 59.0
03	226 39.6	58.0
04	241 39.8	57.1
05	256 40.1	56.1
06	271 40.3 N	0 55.1
07	286 40.5	54.1
08	301 40.7	53.2
09	316 41.0	52.2
10	331 41.2	51.2
11	346 41.4	50.3
12	1 41.6 N	0 49.3
13	16 41.8	48.3
14	31 42.1	47.3
15	46 42.3	46.4
16	61 42.5	45.4
17	76 42.7	44.4
18	91 43.0 N	0 43.5
19	106 43.2	42.5
20	121 43.4	41.5
21	136 43.6	40.5
22	151 43.8	39.6
23	166 44.1	38.6
S.D. 16.0		d 1.0

INCREMENTS AND CORRECTIONS

m	SUN PLANETS	ARIES	MOON	v or Corr <sup>n</sup> d	v or Corr <sup>n</sup> d	v or Corr <sup>n</sup> d
00	11 45-0	11 46-9	11 12-9	0-0 0-0	6-0 4-8	12-0 9-5
01	11 45-3	11 47-2	11 13-1	0-1 0-1	6-1 4-8	12-1 9-6
02	11 45-5	11 47-4	11 13-4	0-2 0-2	6-2 4-9	12-2 9-7
03	11 45-8	11 47-7	11 13-6	0-3 0-2	6-3 5-0	12-3 9-7
04	11 46-0	11 47-9	11 13-8	0-4 0-3	6-4 5-1	12-4 9-8
05	11 46-3	11 48-2	11 14-1	0-5 0-4	6-5 5-1	12-5 9-9
06	11 46-5	11 48-4	11 14-3	0-6 0-5	6-6 5-2	12-6 10-0
07	11 46-8	11 48-7	11 14-6	0-7 0-6	6-7 5-3	12-7 10-1
08	11 47-0	11 48-9	11 14-8	0-8 0-6	6-8 5-4	12-8 10-1
09	11 47-3	11 49-2	11 15-0	0-9 0-7	6-9 5-5	12-9 10-2
10	11 47-5	11 49-4	11 15-3	1-0 0-8	7-0 5-5	13-0 10-3
11	11 47-8	11 49-7	11 15-5	1-1 0-9	7-1 5-6	13-1 10-4
12	11 48-0	11 49-9	11 15-7	1-2 1-0	7-2 5-7	13-2 10-5
13	11 48-3	11 50-2	11 16-0	1-3 1-0	7-3 5-8	13-3 10-5
14	11 48-5	11 50-4	11 16-2	1-4 1-1	7-4 5-9	13-4 10-6

A<sub>2</sub> ALTITUDE CORRECTION TABLES 10°-90°

OCT.—MAR. SUN			APR.—SEPT.		
App. Alt.	Lower Limb	Upper Limb	App. Alt.	Lower Limb	Upper Limb
43 59	+15-3	-17-0	45 31	-15-1	-16-7
47 10	+15-4	-16-9	48 55	+15-2	-16-6
50 46	+15-5	-16-8	52 44	+15-3	-16-5
54 49	+15-6	-16-7	57 02	+15-4	-16-4
59 23	+15-7	-16-6	61 51	+15-5	-16-3
64 30	+15-8	-16-5	67 17	+15-6	-16-2
70 12	+15-9	-16-4	73 16	+15-7	-16-1
76 26	+16-0	-16-3	79 43	+15-8	-16-0
83 05	+16-1	-16-2	86 32	+15-9	-15-9
90 00			90 00		

DIP		
Ht. of Eye	Corr <sup>n</sup>	Ht. of Eye
m		ft.
8-8		29-2
9-2	-5-3	30-4
9-5	-5-4	31-5
9-9	-5-5	32-7
10-3	-5-6	33-9
10-6	-5-7	35-1
11-0	-5-8	36-3
11-4	-5-9	37-6
11-8	-6-0	38-9
12-2	-6-1	40-1
	-6-2	

Figure 9-2. - Extracts from the Nautical Almanac.

10°, 350° L.H.A.

LATITUDE SAME NAME AS DECLINATION

Dec.	38°			39°			40°			41°			42°			43°			
	Hc	d	Z	Hc	d	Z	Hc	d	Z	Hc	d	Z	Hc	d	Z	Hc	d	Z	
0	50	54.0	58.5	49	56.2	58.7	48	58.4	58.7	48	00.5	58.8	47	02.5	58.9	46	04.5	58.9	165.5
1	51	52.5	58.5	50	54.9	58.5	49	57.1	58.7	48	59.3	58.8	48	01.4	58.9	47	03.4	59.0	165.2
2	52	51.0	58.4	51	53.4	58.6	50	55.8	58.6	49	58.1	58.7	49	00.3	58.8	48	02.4	58.9	165.0
3	53	49.4	58.3	52	52.0	58.4	51	54.4	58.6	50	56.8	58.7	49	59.1	58.7	49	01.3	58.8	164.7
4	54	47.7	58.2	53	50.4	58.4	52	53.0	58.5	51	55.5	58.6	50	57.8	58.7	50	00.1	58.8	164.4

INTERPOLATION TABLE

Dec. Inc.	Altitude Difference (d)																			
	Tens					Decimals					Units									
	10'	20'	30'	40'	50'	0	1	2	3	4	5	6	7	8	9					
32.0	5.3	10.6	16.0	21.3	26.6	.0	0.0	0.5	1.1	1.6	2.2	2.7	3.2	3.8	4.3	4.9				
32.1	5.3	10.7	16.0	21.4	26.7	.1	0.1	0.6	1.1	1.7	2.2	2.8	3.3	3.8	4.4	4.9				
32.2	5.3	10.7	16.1	21.4	26.8	.2	0.1	0.6	1.2	1.7	2.3	2.8	3.4	3.9	4.4	5.0				
32.3	5.4	10.8	16.1	21.5	26.9	.3	0.2	0.7	1.2	1.8	2.3	2.9	3.4	4.0	4.5	5.0				
32.4	5.4	10.8	16.2	21.6	27.0	.4	0.2	0.8	1.3	1.8	2.4	2.9	3.5	4.0	4.5	5.1				
32.5	5.4	10.8	16.3	21.7	27.1	.5	0.3	0.8	1.4	1.9	2.4	3.0	3.5	4.1	4.6	5.1				
32.6	5.4	10.9	16.3	21.7	27.2	.6	0.3	0.9	1.4	1.9	2.5	3.0	3.6	4.1	4.7	5.2				
32.7	5.5	10.9	16.4	21.8	27.3	.7	0.4	0.9	1.5	2.0	2.5	3.1	3.6	4.2	4.7	5.3				
32.8	5.5	11.0	16.4	21.9	27.4	.8	0.4	1.0	1.5	2.1	2.6	3.1	3.7	4.2	4.8	5.3				
32.9	5.5	11.0	16.5	22.0	27.5	.9	0.5	1.0	1.6	2.1	2.7	3.2	3.7	4.3	4.8	5.4				

Figure 9-3. - Extracts from Pub No. 229 Vol.3.

FINDING GREENWICH HOUR ANGLE AND MERIDIAN ANGLE

The Nautical Almanac tabulates:

- a. For each hour of GMT, the GHA of the first point of Aries, navigational planets, sun, and moon.
- b. The SHA's by dates for all navigational stars.
- c. Additional increments of GHA for minutes and seconds elapsed after the hour.

The first step in finding meridian angle "t" is the computation of GHA which is accomplished as follows:

SUN - Using GMT, and Greenwich date of observation, enter Nautical Almanac and record tabulated hourly value of GHA. Turn to the yellow pages of the Nautical Almanac,

and entering with the minutes and seconds after the hour, find the increase in the sun's GHA since the last tabulated (hourly) value. Add the tabulated value and the increase for elapsed minutes and seconds.

MOON AND PLANETS - Proceed as with the sun, but record a code value identified as "v" together with sign which appears at the foot of the GHA sub-column for planets, and to the right of each tabulated GHA for the moon. Find the sum of the hourly value and the minute-second increment, as in the case of the sun, but using column headed "moon" or "sun-planets" as appropriate, then apply a code correction according to the sign of the code. This code correction is found in the yellow pages of the Nautical Almanac, entering with minutes elapsed since beginning of hour, and the code. The code correction is always plus for GHA except in the case of the inferior planet Venus, which has an orbit inside the earth's

orbit. Its apparent motion westward, as compared with the sun's motion, shows that Venus has a numerically lesser, relative speed. When its correction should be subtracted, the code letter "v" will be prefixed by a minus sign. The purpose of the code correction is to simplify interpolation and to keep tabulated values at a minimum. For the planets, the code correction makes possible the use of the GHA value for minutes and seconds as tabulated for the sun.

STARS - Determine the SHA from the daily page, entering with the star name and Greenwich date. Find the GHA of  $\Upsilon$  in the same manner as used to find the GHA of the sun (except that in the yellow pages a separate column is provided for  $\Upsilon$ ). Adding the GHA of  $\Upsilon$  and the SHA of the star, we find the GHA of the star.

A code correction is never used in connection with the sun's GHA, the GHA of  $\Upsilon$ , or the SHA of a star. To convert GHA to LHA, and LHA to meridian angle (t), the following relationships, as discussed earlier, are used:

$$\begin{aligned} \text{LHA} &= \text{GHA} - W\lambda \\ \text{LHA} &= \text{GHA} + E\lambda \\ \text{GHA}^* &= \text{GHA} + \text{SHA}^* \\ \text{LHA} &> 180, t = 360 - \text{LHA}, \text{ and } t \text{ is east.} \\ \text{LHA} &< 180, t = \text{LHA}, \text{ and } t \text{ is west.} \end{aligned}$$

The examples illustrate the complete problem of finding GHA and "t."

#### EXAMPLE 1:

Given: 1 Jan. 1970, ZT 11-18-45, Long. 71-30 W.

Required: GHA and t of sun.

Solution:

ZT	11-18-45	1 Jan.
ZD	+5	(71-30/15)
GMT	16-18-45	1 Jan.
GHA (16 hrs.)	59-06.0	
Min-sec (18-45)	4-41.3	
GHA of sun	63-47.3	or 423-47.3
Long.		-71-30.0 W.
LHA		352-17.3
t = 360 - LHA or		7-42.7 E.

In the actual practice of sight reduction, an "assumed longitude" is used in lieu of the "actual longitude." This procedure simplifies subsequent computation as it permits the assumption of a longitude which, when combined with the GHA, results in a local hour angle, and a meridian angle, in even degrees. For example, in west longitude, the longitude assumed should include precisely the same number of minutes (and tenths of minutes) as the GHA. Upon subtracting the assumed longitude the remaining local hour angle will result accordingly in even degrees. In east longitude, the longitude assumed should include the number of minutes (and tenths) which when added to the GHA will also result in a local hour angle, and "t," in even degrees. In using this procedure, a longitude should be assumed within 30' of the navigator's best estimate of position.

#### FINDING DECLINATION

The Nautical Almanac tabulates declination for the sun, moon, and navigational planets for each hour of GMT. At the foot of each declination sub-column which applies to the sun or planets, a code may be found which is useful for interpolation for any number of minutes. The code follows each tabulated declination of the moon, since the moon's declination changes rapidly as compared to the declination of the sun and planets. To find the change in declination for

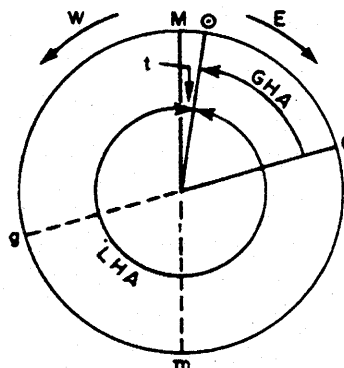

**EXAMPLE 2:**

Given: 2 Jan. 1970, ZT 09-19-55, Long. 169-15 E.

Required: GHA and t of moon.

Solution:

ZT	09-19-55	2 Jan.
ZD	-11	(169-15/15)
GMT	22-19-55	1 Jan.
GHA (22 hrs.)		231-39.4 (13.8)
Min-sec (19-55)		4-45.1
Code Corr.		4.5
GHA of Moon		236-29.0
Long.		+169-15.0 E.
		<u>405-44.0</u>
		-360-00.0
LHA		45-44.0
t = LHA or		45-44.0 W.

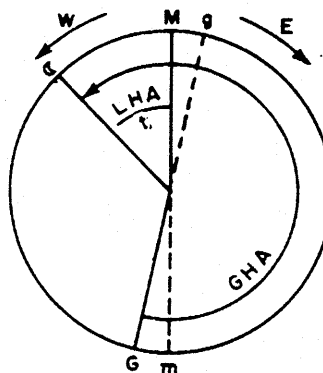

**EXAMPLE 3:**

Given: 2 Jan. 1970, ZT 18-20-00, Long. 110-10 W.

Required: GHA and t of Venus.

Solution:

ZT	18-20-00	2 Jan.
ZD	+7	(104-10/15)
GMT	01-20-00	3 Jan.
GHA (01 hr.)		199-34.6 (1.0)
Min-sec (20 min)		5-00.0
Code Corr.		- 0.3
GHA of Venus		204-34.3
Long.		110-10.0 W.
LHA		94-24.3
t = LHA or		94-24.3 W.

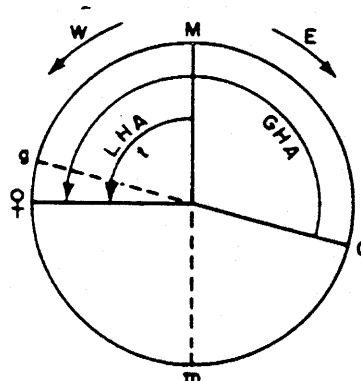

**EXAMPLE 4:**

Given: 3 Jan. 1970, ZT 06-00-00, Long. 92-00 E.

Required: GHA and t of Vega.

Solution: Using star name, enter SHA table on daily page; SHA is 81-01.6. Find GHA of Aries.

ZT	06-00-00	3 Jan.
ZD	-6	(92-00/15).
GMT	00-00-00	3 Jan.
GHA $\Upsilon$ (00 hrs.)		102-12.1
SHA of Vega		81-01.6
GHA of Vega		183-13.7
Long.		+92-00.0 E.
LHA		275-13.7
t = 360 - LHA or		84-46.3 E.

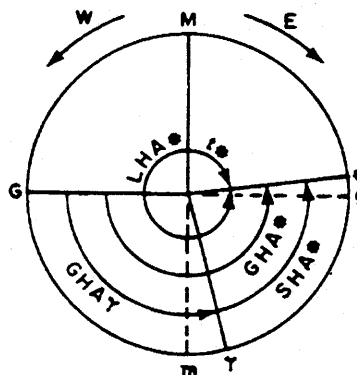

a part of an hour, enter the yellow pages with the number of minutes and the code. The tabulated declination is prefixed by either an N or S, indicating north or south declination, respectively. The sign of the code correction for elapsed minutes must be determined by inspection of the declination column, noting if declination is increasing or decreasing, between the two hours in question. Combine the tabulated declination and the code correction and label the result with "north" or "south" as appropriate.

To find the tabulated declination of a star, enter the daily page with the star name and Greenwich date. No code correction is necessary since the declination is relatively constant and cannot be expected to change within any three day period.

**EXAMPLE 1:**

Given: GMT 11-18-45 2 Jan. 1970.

Required: Declination of the sun.

Solution: Declination(11 hrs.)S 22-56.1(0.2)  
 Code Correction -0.1  
 Declination 22-56.0 South

**EXAMPLE 2:**

Given: GMT 18-19-25 1 Jan. 1970.  
 Required: Declination of the moon.  
 Solution: Declination(18 hrs.)S 10-41.3(14.3)  
 Code Correction +4.6  
 Declination 10-45.9 South

**EXAMPLE 3:**

Given: GMT 05-18-26 3 Jan. 1970.  
 Required: Declination of Saturn.  
 Solution: Declination (5 hrs.) N 9-49.8 (0.0)  
 Declination 9-49.8 North

**EXAMPLE 4:**

Given: 2 Jan. 1970.  
 Required: Declination of Dubhe.  
 Solution: Tabulated declination of Dubhe is 61-54.5 North on 2 Jan. 1970.

In most celestial computations, GHA and declination are determined concurrently rather than separately, thereby saving time in obtaining vital data from the almanac.

### SELF-QUIZ #9

Using Appendixes A and B, answer questions 1 through 33.

1. Determine the altitude correction for the sun's lower limb on October 22, if  $h_a = 30^\circ 48'$ .
  - A. +14.5
  - B. +14.6
  - C. +14.7
  - D. +14.8
2. Determine the dip correction if height of eye is 38.8 feet.
  - A. -5.9
  - B. -6.0
  - C. -6.1
  - D. -6.15
3. Determine the GHA of the sun at GMT 22 hrs 56 mins 29 secs on 12 December.
  - A.  $151^\circ 30'.7$
  - B.  $165^\circ 37'.0$
  - C.  $165^\circ 38'.0$
  - D.  $165^\circ 40'.3$
4. Determine the GHA of Sirius at GMT 09 hrs 26 mins 13 secs on 12 December.
  - A.  $121^\circ 27'.2$
  - B.  $121^\circ 28'.2$
  - C.  $215^\circ 56'.9$
  - D.  $258^\circ 57'.0$
5. Determine the GHA of Venus at GMT 09 hrs 57 mins 07 secs on 12 December.
  - A.  $230^\circ 13'.7$
  - B.  $230^\circ 16'.0$
  - C.  $341^\circ 19'.5$
  - D.  $341^\circ 21'.8$
6. What was the apparent altitude?
  - A.  $49^\circ 05'.6$
  - B.  $48^\circ 55'.4$
  - C.  $48^\circ 50'.4$
  - D.  $48^\circ 45'.2$
7. What was the altitude correction?
  - A. -15.2
  - B. +15.1
  - C. +10.2
  - D. -10.1
8. What was the  $H_o$ ?
  - A.  $49^\circ 02'.9$
  - B.  $49^\circ 03'.0$
  - C.  $49^\circ 05'.5$
  - D.  $49^\circ 05'.6$
9. What was the total correction applied to sextant altitude to obtain  $H_o$ ?
  - A. 7.5
  - B. 7.6
  - C. 10.1
  - D. 10.2

USE THE FOLLOWING INFORMATION TO ANSWER QUESTIONS 10, 11, 12, 13, and 14.

A vessel's DR position was Lat.  $41^\circ 09'.5$  N, Long.  $53^\circ 30'$  W. Having obtained a sun line, the navigator determined the local hour angle of the sun to be  $18^\circ$ , Dec was  $S23^\circ 23'$ .

USE THE FOLLOWING INFORMATION TO ANSWER QUESTIONS 6, 7, 8, and 9.

A navigator determined sextant error to be  $1'.3$  off, the height of eye was 42 feet and the sextant altitude of the sun's lower limb at 1020 zone time on 28 September was  $48^\circ 55'.4$ .

10. What was the Dec Inc?
  - A. 23.0
  - B. 20.0
  - C. 11.5
  - D. 7.0
11. What was the d corr.?
  - A. + 58.0
  - B. - 58.0
  - C. + 23.0
  - D. - 23.0



SELF-QUIZ #9 (Cont'd)

12. What was Z?

- A.  $161^{\circ}.8$
- B.  $161^{\circ}.9$
- C.  $162^{\circ}.0$
- D.  $162^{\circ}.2$

13. What was the Zn?

- A.  $198^{\circ}.2$
- B.  $198^{\circ}.1$
- C.  $198^{\circ}$
- D.  $162^{\circ}$

14. What was the Hc?

- A.  $23^{\circ} 15'.3$
- B.  $23^{\circ} 28'.9$
- C.  $23^{\circ} 29'.2$
- D.  $24^{\circ} 13'.8$

USE WORK FORM AND THE FOLLOWING INFORMATION TO ANSWER QUESTIONS 15 THROUGH 19.

A navigator determined sextant error to be 1'.6 off, the height of eye was 34 feet and the sextant altitude of the moon's upper limb at 18 hrs 19 mins 09 secs zone time on 18 December 1977 was  $53^{\circ} 57'.3$ . ZD +4, DR position  $41^{\circ}\text{N}$ ,  $53^{\circ} 20'\text{W}$ .

15. What was the local hour angle?

- A.  $355^{\circ}$
- B.  $305^{\circ}$
- C.  $55^{\circ}$
- D.  $5^{\circ}$

16. What was the v correction?

- A. +13.5
- B. -13.5
- C. + 4.4
- D. - 4.4

17. What was the d correction?

- A. +3.1
- B. -3.1
- C. +9.6
- D. -9.6

18. What was the H.P.?

- A. 61.2
- B. 55.8
- C. 30.0
- D. 2.2

19. What was the total correction applied to sextant altitude to obtain Ho?

- A. +77.0
- B. +47.0
- C. +17.0
- D. +14.0

USE THE FOLLOWING INFORMATION TO ANSWER QUESTIONS 20 THROUGH 22.

A navigator determined sextant error to be 1'.6 off, the height of eye was 34 feet, and the sextant altitude of Jupiter at 09 hrs 21 mins 56 secs GMT on 18 December was  $20^{\circ} 47.2$  DR position Lat.  $41^{\circ}\text{N}$ , Long.  $53^{\circ} 40'\text{W}$ .

20. What was the GHA?

- A.  $135^{\circ} 31'.5$
- B.  $135^{\circ} 30'.6$
- C.  $130^{\circ} 00'.6$
- D.  $87^{\circ} 05'.3$

21. What was the LHA?

- A.  $278^{\circ}$
- B.  $188^{\circ}$
- C.  $102^{\circ}$
- D.  $82^{\circ}$

22. What was the Ho?

- A.  $20^{\circ} 45'.3$
- B.  $20^{\circ} 41'.2$
- C.  $20^{\circ} 40'.6$
- D.  $20^{\circ} 40'.4$

USE THE FOLLOWING INFORMATION TO ANSWER QUESTIONS 23 THROUGH 33.

At 0500 ZT on 10 December, a vessel's DR position was Lat.  $41^{\circ} 05'.5\text{N}$ , Long.  $51^{\circ} 20'\text{W}$ . During morning twilight the navigator observed three stars with results as follows:

### SELF-QUIZ #9 (Cont'd)

WE 2m 26s fast, index error 1'.6 off, HEIGHT OF EYE 34 FEET. CLOCKS KEEPING +3 TIME.

BODY	ARCTURUS	REGULUS	PROCYON
WATCH	05-45-26	05-47-52	05-48-15
hs	38°21'.4	60°35'.5	36°54'.1

23. Determine GMT of Procyon.
- 05-45-49
  - 05-50-41
  - 08-45-49
  - 08-50-41
24. Determine the ha of Regulus.
- 60° 50'.8
  - 60° 31'.4
  - 36° 36'.4
  - 36° 06'.6
25. Determine the Zn of Regulus.
- 194° .1
  - 193° .9
  - 166° .1
  - 165° .9
26. Determine the altitude difference for Arcturus.
- 17.8
  - +17.8
  - 36.5
  - +36.5
27. Determine the Ho of Procyon.
- 36° 56'.2
  - 36° 54'.1
  - 36° 50'.0
  - 36° 48'.7
28. Determine the local hour angle of Arcturus.
- 305°
  - 236°
  - 124°
  - 56°
29. Determine the GHA of Procyon.
- 95° 52'.8
  - 95° 33'.6
  - 275° 52'.8
  - 275° 33'.6
30. Determine the Hc of Regulus.
- 60° 35'.5
  - 60° 30'.9
  - 60° 25'.8
  - 60° 21'.4
31. Determine the altitude intercept of Arcturus.
- 26.4A
  - 26.4T
  - 9.2A
  - 9.2T
32. Determine the altitude intercept of Procyon.
- 7.5A
  - 7.5T
  - 12.6A
  - 12.6T
33. Determine the position of the three star fix.
- 40° 58'N, 51° 36'.2W
  - 40° 56'N, 51° 40'.0W
  - 40° 55'N, 51° 39'.5W
  - 40° 45'N, 51° 25'.0W

## ANSWERS TO SELF-QUIZ #9

QUESTION	ANSWER	REFERENCE
1	C	A-11
2	B	A-11
3	C	9-13
4	B	9-13
5	C	9-13
6	C	9-14
7	B	9-14
8	C	9-14
9	C	9-14
10	A	9-14
11	B	9-14
12	C	9-14
13	C	9-14
14	B	9-14
15	A	9-14
16	C	9-14
17	A	9-14
18	B	9-14
19	C	9-14
20	B	9-15
21	D	9-15
22	C	9-15
23	C	9-16
24	B	9-16
25	B	9-16
26	D	9-16
27	D	9-16
28	A	9-16
29	A	9-16
30	C	9-16
31	A	9-16
32	A	9-16
33	B	9-17

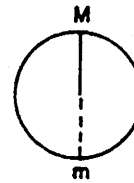
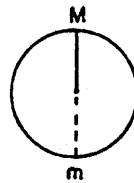
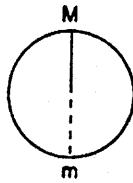

Body	SUN	SIRIUS	VENUS
TC			
Dip(Hr )			
Sum			
hs			
ha			
Alt. Corr.			
Add'l.			
H.P.( )			
Corr. to ha			
Ho (Obs Alt)			
Date			
DR Lat			
DR Long			
Obs. Time			
WE(S+, F-)			
ZT			
ZD(W+, E-)			
GMT			
Date (GMT)	3	4	5
Tab GHA v	151 30.7	215 56.9	327 02.7
GHA incr'mt.	14 07.3	6 34.3	14 16.8
SHA or v Corr.		258 57.0	
GHA	165 39.0	481 28.2	341 19.5
+ 360 if needed		121 28.2	
a λ (-W, +E)			
LHA			
Tab Dec d			
d Corr. (+ or -)			
True Dec			
a Lat (N or S)			
Dec Inc (±)d			
Hc (Tab.Alt.)			
tens DS Diff.			
units DS Corr.			
Tot. Corr.(+ or -)			
Hc (Comp. Alt.)			
Ho (Obs. Alt.)			
a (Intercept)			
Z			
Zn (°T)			

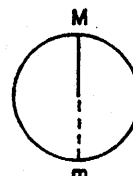
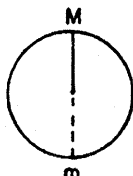
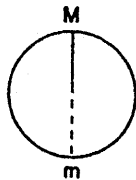

Body 6,7,8,9

	SUN ☉	SUN ☉	MOON ☾
IC	+1.3	10,11,12,13,14	+1.6
Dip(Hr 42 )	-6.3		-5.7
Sum	-5.0	(9)	-4.1
hs	48° 55.4	(6)	53 57.4
ha	48 50.4	(7/9)	53 53.3
Alt. Corr.	+15.1		+44.0
Add'l.			-30.0
H.P.( )			(55.8) +3.0 (18)
Corr. to ha			+17.0 (19)
Ho (Obs. Alt)	49 05.5 (8)		54 10.3
Date	28 Sept		18 Dec 1977
DR Lat		41° 09.5N	41°N
DR Long		53° 30'W	53° 20'W
Obs. Time			
WE(S+,F-)			
ZT			18 19 09
ZD(W+,E-)			+4
GMT			22 19 09
Date (GMT)			18 Dec 1977
Tab GHA	v		44 19.0
GHA incr'mt.			4 34.2
SHA or v Corr.			13.5 T 4.4 (16)
GHA			48 57.6
+ 360 if needed			408 57.6
a λ (-W,+E)			53 57.6W
LHA		18° 00.0	355 00.0 (15)
Tab Dec	d		N 5 25.4
d Corr. (+ or -)			(9.6) + 3.1 (17)
True Dec		23 23.0	N 5 28.5
a Lat (N or S)			41°N
Dec Inc 3.0 (±)d		(10)	+ 28.5
Hc (Tab. Alt.) -58.0	(11)	23 51.1	53 43.3
tens 50 DS Diff.		19.1	50 23.8
units DS Corr.		3.1	96 4.6
Tot. Corr. (+ or -)		22.2	+ 28.4
Hc (Comp. Alt.)		23 28.9 (14)	54 11.7
Ho (Obs. Alt.)			54 10.3
a (Intercept)			1.4A
Z		162.0 (12)	171.5
Zn (°T)		198.0 (13)	171.5

15,16,17  
18,19

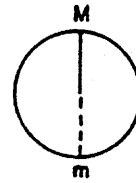
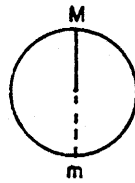
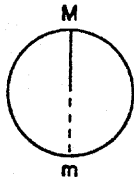

Body 20, 21, 22

JUPITER

IC	+1.6		
Dip(Hr 34 )	-5.7		
Sum	-4.1		
hs	20 47.2		
ha	20 43.1		
Alt. Corr.	-2.5		
Add'l.			
H.P.( )			
Corr. to ha	-2.5		
Ho (Obs Alt)	20 40.6	(22)	
Date	18 Dec 1977		
DR Lat	41°N		
DR Long	53° 40'W		
Obs. Time			
wE(S+,F-)			
ZT			
ZD(w+,F-)			
GMT	09 21 56		
Date (GMT)	18 Dec 1977		
Tab GHA v	130 00.6		
GHA incr'mt.	5 29.0		
SHA or v Corr.	(+2.8) 1.0		
GHA	135 30.6	(20)	
± 360 if needed			
a λ (-W,+E)	53 30.6W		
LHA	82° 00.0	(21)	
Tab Dec d	N 23 09.7		
d Corr. (+ or -)	0.0		
True Dec	N 23 09.7		
a Lat (N or S)	41°N		
Dec Inc (+)d	+9.7		
Hc (Tab.Alt.)	20 40.4		
tens DS Diff.	(+30) 4.9		
units DS Corr.	(+5.9) .9		
Tot. Corr.(+ or -)	+ 5.8		
Hc (Comp. Alt.)	20 46.2		
Ho (Obs. Alt.)	20 40.6		
a (Intercept)	5.6A		
Z	77.0		
Zn (°T)	283.0		

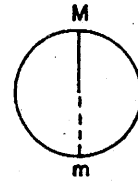
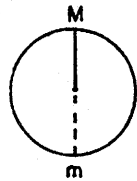
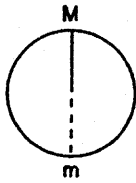

23 through 33

Body	ARCTURUS	REGILUS	PROCYON
IC	+1.6	+1.6	+1.6
Dip(Ht 34 )	-5.7	-5.7	-5.7
Sum	-4.1	-4.1	-4.1
hs	38° 21'.14	60° 35'.5	36° 54'.1
ha	38° 17'.3	(24) 60° 31'.4	36° 50'.0
Alt. Corr.	-1.2	-0.5	-1.3
Add'l.			
H.P.( )			
Corr. to ha	-1.2	-0.5	-1.3
Hc (Obs Alt)	38° 16'.1	60° 30'.9	36° 48'.7 (27)
Date	10 Dec 1977	10 Dec 1977	10 Dec 1977
DR Lat	41°N	41°N	41°N
DR Long	51° 20'W	51° 20'W	51° 20'W
Obs. Time	05 45 26	05 47 52	05 48 15
WE(S+,F-)	- 2m 26s	-2m 26s	2m 26s
ZT	05 43 00	05 45 26	05 45 49
ZD(W+,E-)	+3	+3	+3
GMT	08 43 00	08 45 26	08 45 49 (23)
Date (GMT)	10 Dec 1977	10 Dec 1977	10 Dec 1977
Tab GHA   v	198 56.2	198 56.2	198 56.2
GHA incr'mt.	10 46.8	11 23.4	11 29.1
SHA or v Corr.	146 20.5	208 11.9	245 27.5
GHA	356 03.5	418 31.5	455 52.8
T T 360 if needed		58 31.5	95 52.8 (29)
a λ (-W,+E) (28)	51 03.5	51 31.5	51 52.8
LHA	305 00.0	7 00.0	44 00.0
Tab Dec   d	N 19 17.8	N 12 04.4	N 5 16.8
d Corr. (+ or -)			
True Dec	N 19 17.8	N 12 04.4	N 5 16.8
a Lat (N or S)	41°N	41°N	41°N
Dec Inc (+)d+	17.8)	04.4)	16.8)
Hc (Tab.Alt.)	38 31.7	60 21.4	36 43.6
tens   DS Diff	30) + 8.9	50) + 3.7	40) + 11.2
units   DS Corr. (26)	6.5) + 1.9	8.9) + 0.7	4.8) + 1.4
Tot. Corr.(+ or -)	+ 10.8	+4.4	(+) 12.6
Hc (Comp. Alt.)	38 42.5	60 25.8 (30)	36 56.2
Ho (Obs. Alt.)	38 16.1	60 30.9	36 48.7
a (Intercept) (31)	26.4A	5.1T	7.5A (32)
Z	97.8	166.1	120.1
Zn (°T)	97.8	(25) 193.9	239.9

(33) 40° 56'N 51° 40'W21

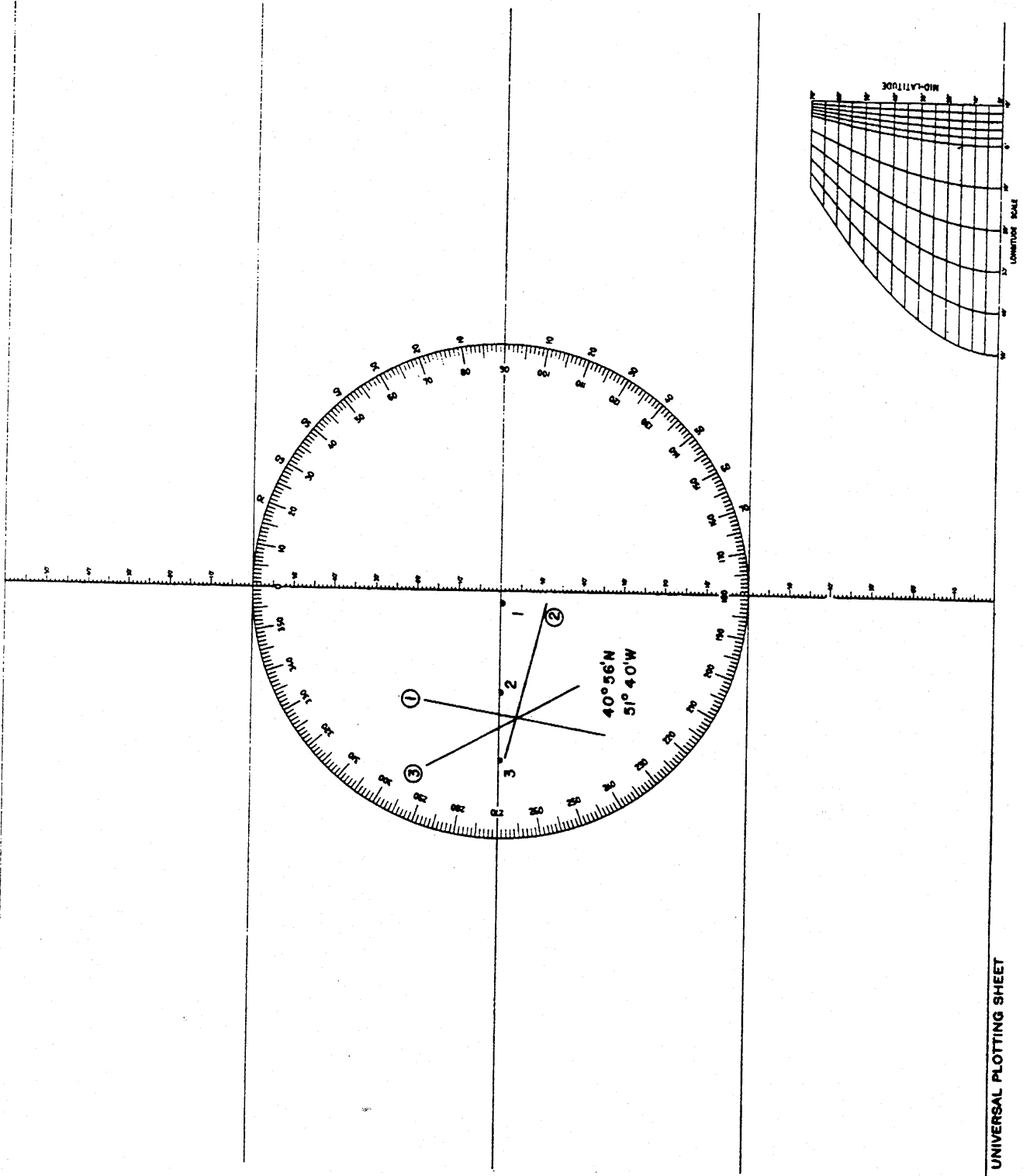



# THE NAUTICAL ALMANAC

## WASHINGTON:

Issued by the  
Nautical Almanac Office  
United States  
Naval Observatory  
under the  
authority of the  
Secretary of the Navy

## LONDON:

Issued by  
Her Majesty's  
Nautical Almanac Office  
by order  
of the  
Secretary of State  
for Defence



U.S. GOVERNMENT PRINTING OFFICE

WASHINGTON : 1975

---

For sale by the Superintendent of Documents, U.S. Government Printing Office  
Washington, D.C. 20402 - Price \$7.20  
Stock Number 008-054-00065-7

# PLANET NOTES, 1977

## POSITIONS OF PLANETS

**VENUS** is easily identified by its superior brilliance. It is an evening star until the end of March when it becomes too close to the Sun for observation. From the middle of April it is a morning star until the beginning of December, when it again becomes too close to the Sun for observation. Venus is in conjunction with Mars on May 13 and June 3, with Jupiter on July 30 and Saturn on September 18.

**MARS** is too close to the Sun for observation during the first half of January; it is visible as a morning star for the remainder of the year. Mars is in Sagittarius from January until mid-February, and then moves through Capricornus, Aquarius, Pisces, Aries, Taurus (passing 5° N. of *Aldebaran* on August 1), Gemini (passing 6° S. of *Pollux* on October 13) and into Cancer later in October, where it remains for the rest of the year. Mars is in conjunction with Mercury on January 12 and February 12, with Venus on May 13 and June 3, and with Jupiter on September 4.

**JUPITER** is an evening star from the beginning of the year until the middle of May when it becomes too close to the Sun for observation. From the second half of June it is a morning star until opposition on December 23, when it becomes an evening star for the rest of the year. Jupiter is in conjunction with Venus on July 30, and with Mars on September 4.

**SATURN** is a morning star until opposition on February 2, when it becomes an evening star until the end of July. It is then too close to the Sun for observation until the end of August, when it becomes visible as a morning star for the remainder of the year. Saturn is in Cancer at the beginning of the year, moving into Leo in July where it remains for the rest of the year, passing 0° 8' N. of *Regulus* on November 3. Saturn is in conjunction with Mercury on July 20 and with Venus on September 18.

**MERCURY** can only be seen low in the east before sunrise, or low in the west after sunset (about the time of beginning or end of civil twilight). It is visible in the mornings during the following approximate dates: January 10 (1.9) to March 4 (0.7), May 7 (2.5) to June 22 (1.4), September 11 (1.6) to October 5 (1.1), December 26 (2.2) to December 31 (0.6); the planet is brighter at the end of each period. It is visible in the evenings between the following approximate dates: March 26 (1.3) to April 24 (2.5), July 9 (1.0) to September 1 (2.4), November 4 (0.5) to December 17 (1.7); the planet is brighter at the beginning of each period. The figures in parentheses are the magnitudes.

## PLANET DIAGRAM

*General Description.* The diagram on the opposite page shows, in graphical form for any date during the year, the local mean time of meridian passage of the Sun, of the five planets Mercury, Venus, Mars, Jupiter, and Saturn, and of each 30' of S.H.A.; intermediate lines, corresponding to particular stars, may be drawn in by the user if he so desires. It is intended to provide a general picture of the availability of planets and stars for observation.

On each side of the line marking the time of meridian passage of the Sun a band, 45" wide, is shaded to indicate that planets and most stars crossing the meridian within 45" of the Sun are too close to the Sun for observation.

*Method of use and interpretation.* For any date the diagram provides immediately the local mean times of meridian passage of the Sun, planets and stars, and thus the following information:

- whether a planet or star is too close to the Sun for observation;
- whether a planet is a morning or evening star;
- some indication of its position during twilight;
- the proximity of other planets.

When the meridian passage occurs at midnight the body is in opposition to the Sun and is visible all night; planets may be observable in both morning and evening twilights. As the time of meridian passage decreases, the body ceases to be observable in the morning, but its altitude above the eastern horizon during evening twilight gradually increases; this continues until the body is on the meridian at twilight. From then onwards the body is observable above the western horizon and its altitude at evening twilight gradually decreases; eventually the body becomes too close to the Sun for observation. When the body again becomes visible it is seen as a morning star low in the east; its altitude at twilight increases until meridian passage occurs at the time of morning twilight. Then, as the time of meridian passage decreases to 0<sup>h</sup>, the body is observable in the west in the morning twilight with a gradually decreasing altitude, until it once again reaches opposition.

## DO NOT CONFUSE

Mercury with Mars in mid-January when both planets have the same magnitude, and again in early February when Mercury is the brighter object.

Venus with Mars in the middle of May and early June, with Jupiter at the end of July, and with Saturn in the latter half of September; on all occasions Venus is the brighter object.

Mercury with Saturn in the latter half of July when Mercury is the brighter object.

Mars with Jupiter at the beginning of September when Jupiter is the brighter object.

# EXPLANATION

## PRINCIPLE AND ARRANGEMENT

1. *Object.* The object of this Almanac is to provide, in a convenient form, the data required for the practice of astronomical navigation at sea.

2. *Principle.* The main contents of the Almanac consist of data from which the *Greenwich Hour Angle* (G.H.A.) and the *Declination* (Dec.) of all the bodies used for navigation can be obtained for any instant of *Greenwich Mean Time* (G.M.T.). The *Local Hour Angle* (L.H.A.) can then be obtained by means of the formula:

$$\text{L.H.A.} = \text{G.H.A.} \begin{array}{l} - \text{west} \\ + \text{east} \end{array} \text{ longitude}$$

The remaining data consist of: times of rising and setting of the Sun and Moon, and times of twilight; miscellaneous calendrical and planning data and auxiliary tables, including a list of Standard Times; corrections to be applied to observed altitude.

For the Sun, Moon, and planets the G.H.A. and Dec. are tabulated directly for each hour of G.M.T. throughout the year. For the stars the *Sidereal Hour Angle* (S.H.A.) is given, and the G.H.A. is obtained from:

$$\text{G.H.A. Star} = \text{G.H.A. Aries} + \text{S.H.A. Star}$$

The S.H.A. and Dec. of the stars change slowly and may be regarded as constant over periods of several days. G.H.A. Aries, or the Greenwich Hour Angle of the first point of Aries (the Vernal Equinox), is tabulated for each hour. Permanent tables give the appropriate increments and corrections to the tabulated hourly values of G.H.A. and Dec. for the minutes and seconds of G.M.T.

The tabular accuracy is 0.1 throughout. The time argument on the daily pages of this Almanac is 12<sup>h</sup> + the Greenwich Hour Angle of the mean sun and is denoted by G.M.T. This scale\* may differ from the broadcast time signals by an amount which, if ignored, will introduce an error of up to 0.2 in longitude determined from astronomical observations. (The difference arises because the time argument depends on the variable rate of rotation of the Earth while the broadcast time signals are now based on an atomic time-scale.) Step adjustments of exactly one second are made to the time signals as required (normally at 24<sup>h</sup> on December 31 and June 30) so that the difference between the time signals and G.M.T., as used in this Almanac, may not exceed 0.7. Those who require to reduce observations to a precision of better than 1" must therefore obtain the correction to the time signals from coding in the signal, or from other sources. The correction may be applied to each of the times of observation: alternatively, the longitude, when determined from astronomical observations, may be corrected by the corresponding amount shown in the following table:

Correction to time signals	Correction to longitude
-0.7	0.2 to east
-0.6 to -0.3	0.1 to east
-0.2 to +0.2	no correction
+0.3 to +0.6	0.1 to west
+0.7	0.2 to west

\*The name universal time (UT) is now often used instead of the name Greenwich Mean Time. The time-scale used in this almanac is denoted by UT1, while the scale of the time signals is denoted by UTC.

## EXPLANATION

3. *Lay-out.* The ephemeral data for three days are presented on an opening of two pages: the left-hand page contains the data for the planets and stars; the right-hand page contains the data for the Sun and Moon, together with times of twilight, sunrise, sunset, moonrise and moonset.

The remaining contents are arranged as follows: for ease of reference the altitude-correction tables are given on pages A2, A3, A4, xxxiv and xxxv; calendar, Moon's phases, eclipses, and planet notes (i.e. data of general interest) precede the main tabulations; the other data follow the main tabulations and are arranged, as far as possible, in order of importance or frequency of use backwards from page xxxv.

### MAIN DATA

4. *Daily pages.* The daily pages give the G.H.A. of Aries, the G.H.A. and Dec. of the Sun, Moon, and the four navigational planets, for each hour of G.M.T. For the Moon, values of  $v$  and  $d$  are also tabulated for each hour to facilitate the correction of G.H.A. and Dec. to intermediate times;  $v$  and  $d$  for the Sun and planets change so slowly that they are given, at the foot of the appropriate columns, once only on the page;  $v$  is zero for Aries and negligible for the Sun, and is omitted. The S.H.A. and Dec. of the 57 selected stars, arranged in alphabetical order of proper name, are also given.

5. *Stars.* The S.H.A. and Dec. of 173 stars, including the 57 selected stars, are tabulated for each month on pages 268-273; no interpolation is required and the data can be used in precisely the same way as those for the selected stars on the daily pages. The stars are arranged in order of S.H.A.

The list of 173 includes all stars down to magnitude 3.0, together with a few fainter ones to fill the larger gaps. The 57 selected stars have been chosen from amongst these on account of brightness and distribution in the sky; they will suffice for the majority of observations.

The 57 selected stars are known by their proper names, but they are also numbered in descending order of S.H.A. In the list of 173 stars, the constellation names are always given on the left-hand page; on the facing page proper names are given where well-known names exist. Numbers for the selected stars are given in both columns.

Stars which, owing to their declinations, are unsuitable for use with the *Tables of Computed Altitude and Azimuth* (H.O. 214 or H.D. 486) are specially indicated.

An index to the selected stars, containing lists in both alphabetical and numerical order, is given on page xxxiii and is also reprinted on the bookmark.

6. *Increments and corrections.* These tables, printed on tinted paper (pages ii-xxxi) at the back of the Almanac, provide the increments and corrections for minutes and seconds to be applied to the hourly values of G.H.A. and Dec. They consist of sixty tables, one for each minute, separated into two parts: increments to G.H.A. for Sun and planets, Aries, and Moon for every minute and second; and, for each minute, corrections to be applied to G.H.A. and Dec. corresponding to the values of  $v$  and  $d$  given on the daily pages.

The increments are based on the following adopted hourly rates of increase of the G.H.A.: Sun and planets,  $15^\circ$  precisely; Aries,  $15^\circ 02' 46''$ ; Moon,  $14^\circ 19' 0''$ . The values of  $v$  on the daily pages are the excesses of the actual hourly motions over the adopted values; they are generally positive, except for Venus. The tabulated hourly values of the Sun's G.H.A. have been adjusted to reduce to a minimum the error caused by treating  $v$  as negligible. The values of  $d$  on the daily pages are the hourly differences of the Dec. For the Moon, the true values of  $v$  and  $d$  are given for each hour; otherwise mean values are given for the three days on the page.

7. *Method of entry.* The G.M.T. of an observation is expressed as a day and hour, followed by a number of minutes and seconds. The tabular values of G.H.A. and Dec., and, where necessary, the corresponding values of  $v$  and  $d$ , are taken directly from the daily pages for the day and hour of G.M.T.; this hour is always *before* the time of observation. S.H.A. and Dec. of the selected stars are also taken from the daily pages.

## EXPLANATION

The table of Increments and Corrections for the minute of G.M.T. is then selected. For the G.H.A., the increment for minutes and seconds is taken from the appropriate column opposite the seconds of G.M.T.; the  $v$ -correction is taken from the second part of the same table opposite the value of  $v$  as given on the daily pages. Both increment and  $v$ -correction are to be added to the G.H.A., except for Venus when  $v$  is prefixed by a minus sign and the  $v$ -correction is to be subtracted. For the Dec. there is no increment, but a  $d$ -correction is applied in the same way as the  $v$ -correction;  $d$  is given without sign on the daily pages and the sign of the correction is to be supplied by inspection of the Dec. column. In many cases the correction may be applied mentally.

8. *Examples.* (a) Sun and Moon. Required the G.H.A. and Dec. of the Sun and Moon on 1977 January 22 at G.M.T.  $15^{\text{h}} 47^{\text{m}} 13^{\text{s}}$ .

	SUN			MOON		
	G.H.A.	Dec.	$d$	G.H.A.	$v$	Dec. $d$
Daily page, Jan. 22 <sup>d</sup> 15 <sup>h</sup>	42 04.7	S.19 36.3	0.6	6 03.0	12.6	S.4 06.6 10.5
Increments for 47 <sup>m</sup> 13 <sup>s</sup>	11 48.3			11 16.0		
$v$ or $d$ corrections for 47 <sup>m</sup>			-0.5	+10.0		-8.3
Sum for Jan. 22 <sup>d</sup> 15 <sup>h</sup> 47 <sup>m</sup> 13 <sup>s</sup>	53 53.0	S.19 35.8		17 29.0		S.3 58.3

(b) Planets. Required the L.H.A. and Dec. of (i) Venus on 1977 January 6 at G.M.T.  $10^{\text{h}} 57^{\text{m}} 28^{\text{s}}$  in longitude E.  $150^{\circ} 55'$ ; (ii) Jupiter on 1977 January 6 at G.M.T.  $23^{\text{h}} 25^{\text{m}} 12^{\text{s}}$  in longitude W.  $55^{\circ} 12'$ .

	VENUS				JUPITER			
	G.H.A.	$v$	Dec.	$d$	G.H.A.	$v$	Dec.	$d$
Daily page, January 6 <sup>d</sup> (10 <sup>h</sup> )	281 19.3	-0.1	S.11 56.1	1.1	(23 <sup>h</sup> ) 42 16.5	2.6	N.17 10.0	0.0
Increments (planets) (57 <sup>m</sup> 28 <sup>s</sup> )	14 22.0				(25 <sup>m</sup> 12 <sup>s</sup> ) 6 18.0			
$v$ or $d$ corrections (57 <sup>m</sup> )	-0.1		-1.1		(25 <sup>m</sup> ) -1.1			0.0
Sum = G.H.A. and Dec.	295 41.2		S.11 55.0		48 35.6		N.17 10.0	
Longitude (east) + $150^{\circ} 55'$					(west) - $55^{\circ} 12'$			
Multiples of $360^{\circ}$	-360				+360			
L.H.A. planet	86 36.2				353 23.6			

(c) Stars. Required the G.H.A. and Dec. of (i) *Aldebaran* on 1977 January 22 at G.M.T.  $15^{\text{h}} 55^{\text{m}} 13^{\text{s}}$ ; (ii) *Vega* on 1977 January 22 at G.M.T.  $16^{\text{h}} 02^{\text{m}} 45^{\text{s}}$ .

	<i>Aldebaran</i>		<i>Vega</i>	
	G.H.A.	Dec.	G.H.A.	Dec.
Daily page (S.H.A. and Dec.)	291 20.6	N.16 27.8	80 57.9	N.38 45.7
Daily page (G.H.A. Aries) (15 <sup>h</sup> )	346 50.8		(16 <sup>h</sup> ) 1 53.3	
Increments (Aries) (55 <sup>m</sup> 13 <sup>s</sup> )	13 50.5		(02 <sup>m</sup> 45 <sup>s</sup> ) 0 41.4	
Sum = G.H.A. star	652 01.9		83 32.6	
Multiples of $360^{\circ}$	-360			
G.H.A. star	292 01.9		83 32.6	

9. *Polaris (Pole Star) tables.* The tables on pages 274-276 provide means by which the latitude can be deduced from an observed altitude of *Polaris*, and they also give its azimuth; their use is explained and illustrated on those pages. They are based on the following formula:

$$\text{Latitude} - \text{corrected sextant altitude} = -p \cos h - \frac{1}{2} p \sin p \sin^2 h \tan (\text{latitude})$$

where

$$p = \text{polar distance of } \textit{Polaris} = 90^{\circ} - \text{Dec.}$$

$$h = \text{local hour angle of } \textit{Polaris} = \text{L.H.A. Aries} + \text{S.H.A.}$$

$a_0$ , which is a function of L.H.A. Aries only, is the value of both terms of the above formula calculated for mean values of the S.H.A. ( $327^{\circ} 26'$ ) and Dec. (N.  $89^{\circ} 09'.7$ ) of *Polaris*, for a mean latitude of  $50^{\circ}$ , and adjusted by the addition of a constant ( $58'.8$ ).  $a_1$ , which is a function of

## EXPLANATION

L.H.A. Aries and latitude, is the excess of the value of the second term over its mean value for latitude  $50^\circ$ , increased by a constant ( $0.6$ ) to make it always positive.  $a_2$ , which is a function of L.H.A. Aries and date, is the correction to the first term for the variation of *Polaris* from its adopted mean position; it is increased by a constant ( $0.6$ ) to make it positive. The sum of the added constants is  $1^\circ$ , so that:

$$\text{Latitude} = \text{corrected sextant altitude} - 1^\circ + a_0 + a_1 + a_2$$

### RISING AND SETTING PHENOMENA

10. *General.* On the right-hand daily pages are given the times of sunrise and sunset, of the beginning and end of civil and nautical twilights, and of moonrise and moonset for a range of latitudes from N.  $72^\circ$  to S.  $60^\circ$ . These times, which are given to the nearest minute, are strictly the G.M.T. of the phenomena on the Greenwich meridian; they are given for every day for moonrise and moonset, but only for the middle day of the three on each page for the solar phenomena.

They are approximately the Local Mean Times (L.M.T.) of the corresponding phenomena on other meridians; they can be formally interpolated if desired. The G.M.T. of a phenomenon is obtained from the L.M.T. by:

$$\text{G.M.T.} = \text{L.M.T.} \begin{matrix} + \text{west} \\ - \text{east} \end{matrix} \text{ longitude}$$

in which the longitude must first be converted to time by the table on page i or otherwise.

Interpolation for latitude can be done mentally or with the aid of Table I on page xxxii.

The following symbols are used to indicate the conditions under which, in high latitudes, some of the phenomena do not occur:

- ☐ Sun or Moon remains continuously above the horizon;
- Sun or Moon remains continuously below the horizon;
- //// twilight lasts all night.

*Basis of the tabulations.* At sunrise and sunset  $16'$  is allowed for semi-diameter and  $34'$  for horizontal refraction, so that at the times given the Sun's upper limb is on the visible horizon; all times refer to phenomena as seen from sea level with a clear horizon.

At the times given for the beginning and end of twilight, the Sun's zenith distance is  $96^\circ$  for civil, and  $102^\circ$  for nautical twilight. The degree of illumination at the times given for civil twilight (in good conditions and in the absence of other illumination) is such that the brightest stars are visible and the horizon is clearly defined. At the times given for nautical twilight the horizon is in general not visible, and it is too dark for observation with a marine sextant.

Times corresponding to other depressions of the Sun may be obtained by interpolation or, for depressions of more than  $12'$ , less reliably, by extrapolation; times so obtained will be subject to considerable uncertainty near extreme conditions.

At moonrise and moonset allowance is made for semi-diameter, parallax, and refraction ( $34'$ ), so that at the times given the Moon's upper limb is on the visible horizon as seen from sea level.

11. *Sunrise, sunset, twilight.* The tabulated times may be regarded, without serious error, as the L.M.T. of the phenomena on any of the three days on the page and in any longitude. Precise times may normally be obtained by interpolating the tabular values for latitude and to the correct day and longitude, the latter being expressed as a fraction of a day by dividing it by  $360^\circ$ , positive for west and negative for east longitudes. In the extreme conditions near ☐, ■ or //// interpolation may not be possible in one direction, but accurate times are of little value in these circumstances.

*Examples.* Required the G.M.T. of (a) the beginning of morning twilights and sunrise on 1977 January 22 for latitude S.  $48^\circ 55'$ , longitude E.  $75^\circ 18'$ ; (b) sunset and the end of evening twilights on 1977 January 24 for latitude N.  $67^\circ 10'$ , longitude W.  $168^\circ 05'$ .

## EXPLANATION

	(a)	Twilight			Sunrise	(b)	Sunset	Twilight		
		Nautical	Civil					Civil	Nautical	
From p. 25		d h m	d h m	d h m		d h m	d h m	d h m	d h m	
L.M.T. for										
Lat.	S.45°	22 03 25	22 04 09	22 04 44	N. 66°	24 14 57	24 16 07	24 17 15		
Corr. to	S.48° 55'	-27	-20	-16	N. 67° 10'	-17	-9	-6		
(p. xxxii)										
Long. (p. i)	E.75° 18'	-5 01	-5 01	-5 01	W.168° 05'	+11 12	+11 12	+11 12		
G.M.T.		21 21 57	21 22 48	21 23 27		25 01 52	25 03 10	25 04 21		

The L.M.T. are strictly for January 23 (middle date on page) and 0° longitude; for precise times it is necessary to interpolate:

(a) to January 22<sup>d</sup> - 75°/360° = Jan. 21<sup>d</sup>.8, i.e.  $\frac{1}{3}(1.2) = 0.4$  backwards towards the data for the same latitude interpolated from page 23; the corrections are -2<sup>m</sup> to nautical twilight, -2<sup>m</sup> to civil twilight and -2<sup>m</sup> to sunrise.

(b) to January 24<sup>d</sup> + 168°/360° = Jan. 24<sup>d</sup>.5, i.e.  $\frac{1}{2}(1.5) = 0.5$  forwards towards the data for the same latitude interpolated from page 27; the corrections are +8<sup>m</sup> to sunset, +5<sup>m</sup> to civil twilight, and +4<sup>m</sup> to nautical twilight.

12. *Moonrise, moonset.* Precise times of moonrise and moonset are rarely needed; a glance at the tables will generally give sufficient indication of whether the Moon is available for observation and of the hours of rising and setting. If needed, precise times may be obtained as follows. Interpolate for latitude, using Table I on page xxxii, on the day wanted and also on the preceding day in east longitudes or the following day in west longitudes; take the difference between these times and interpolate for longitude by applying to the time for the day wanted the correction from Table II on page xxxii, so that the resulting time is between the two times used. In extreme conditions near  or  interpolation for latitude or longitude may be possible only in one direction; accurate times are of little value in these circumstances.

To facilitate this interpolation the times of moonrise and moonset are given for four days on each page; where no phenomenon occurs during a particular day (as happens once a month) the time of the phenomenon on the following day, increased by 24<sup>h</sup>, is given; extra care must be taken when interpolating between two values, when one of those values exceeds 24<sup>h</sup>. In practice it suffices to use the daily difference between the times for the nearest tabular latitude, and generally, to enter Table II with the nearest tabular arguments as in the examples below.

*Examples.* Required the G.M.T. of moonrise and moonset in latitude S. 47° 10', longitudes E. 124° 00' and W. 76° 31' on 1977 January 22.

	Longitude E. 124° 00'		Longitude W. 76° 31'	
	Moonrise d h m	Moonset d h m	Moonrise d h m	Moonset d h m
L.M.T. for Lat. S. 45°	22 08 02	22 20 59	22 08 02	22 20 59
Lat. correction (p. xxxii, Table I)	-02	00	-02	00
Long. correction (p. xxxii, Table II)	-23	-10	+16	+07
Correct L.M.T.	22 07 37	22 20 49	22 08 16	22 21 06
Longitude (p. i)	-8 16	-8 16	+5 06	+5 06
G.M.T.	21 23 21	22 12 33	22 13 22	23 02 12

### ALTITUDE CORRECTION TABLES

13. *General.* In general two corrections are given for application to altitudes observed with a marine sextant; additional corrections are required for Venus and Mars and also for very low altitudes.

Tables of the correction for dip of the horizon, due to height of eye above sea level, are given on pages A2 and xxxiv. Strictly this correction should be applied first and subtracted from the sextant altitude to give apparent altitude, which is the correct argument for the other tables.

## EXPLANATION

Separate tables are given of the second correction for the Sun, for stars and planets (on pages A2 and A3), and for the Moon (on pages xxxiv and xxxv). For the Sun, values are given for both lower and upper limbs, for two periods of the year. The star tables are used for the planets, but additional corrections (page A2) are required for Venus and Mars. The Moon tables are in two parts: the main correction is a function of apparent altitude only and is tabulated for the lower limb (30' must be subtracted to obtain the correction for the upper limb); the other, which is given for both lower and upper limbs, depends also on the horizontal parallax, which has to be taken from the daily pages.

An additional correction, given on page A4, is required for the change in the refraction, due to variations of pressure and temperature from the adopted standard conditions; it may generally be ignored for altitudes greater than 10°, except possibly in extreme conditions. The correction tables for the Sun, stars, and planets are in two parts; only those for altitudes greater than 10° are reprinted on the bookmark.

14. *Critical tables.* Some of the altitude correction tables are arranged as critical tables. In these an interval of apparent altitude (or height of eye) corresponds to a single value of the correction; no interpolation is required. At a "critical" entry the upper of the two possible values of the correction is to be taken. For example, in the table of dip, a correction of -4'·1 corresponds to all values of the height of eye from 5·3 to 5·5 metres (17·5 to 18·3 feet) inclusive.

15. *Examples.* The following examples illustrate the use of the altitude correction tables; the sextant altitudes given are assumed to be taken on 1977 January 22 with a marine sextant at height 5·4 metres (18 feet), temperature -3°C. and pressure 982 mb., the Moon sights being taken at about 10<sup>h</sup> G.M.T.

	SUN lower limb	SUN upper limb	MOON lower limb	MOON upper limb	VENUS	<i>Polaris</i>
Sextant altitude	21 19'·7	3 20'·2	33 27'·6	26 06'·7	4 32'·6	49 36'·5
Dip, height 5·4 metres (18 feet)	-4'·1	-4'·1	-4'·1	-4'·1	-4'·1	-4'·1
Main correction	+13'·8	-29'·6	+57'·4	+60'·5	-10'·8	-0'·8
-30' for upper limb (Moon)	—	—	—	-30'·0	—	—
L, U correction for Moon	—	—	+4'·1	+3'·1	—	—
Additional correction for Venus	—	—	—	—	+0'·2	—
Additional refraction correction	-0'·1	-0'·3	0'·0	-0'·1	-0'·3	0'·0
Corrected sextant altitude	21 29'·3	2 46'·2	34 25'·0	26 36'·1	4 17'·6	49 31'·6

The main corrections have been taken out with apparent altitude (sextant altitude corrected for dip) as argument, interpolating where possible. These refinements are rarely necessary.

16. *Basis of the corrections.* The table for the dip of the sea horizon is based on the formula:  
 Correction for dip =  $-1'·76\sqrt{\text{height of eye in metres}}$  =  $-0'·97\sqrt{\text{height of eye in feet}}$

The mean refraction, given explicitly in the correction table for the stars and planets and incorporated into those for the Sun and Moon, is based on Garfinkel's theory and is for a temperature of 10°C. (50°F.) and a pressure of 1010 mb. (29·83 inches). The additional corrections for variations of temperature and pressure from these adopted means are also based on Garfinkel's theory; there is no significant difference between the various theories to the accuracy given.

The correction table for the Sun includes the effects of semi-diameter and parallax, as well as the mean refraction; no correction for irradiation is included.

The additional corrections for Venus and Mars allow for parallax and phase, and are given by  $p \cos H - k \cos \theta$ , where  $H$  is the altitude,  $\theta$  the angle at the planet between the vertical and the Sun:  $p$  and  $k$  are, for Venus, for 1977:

	Jan. 1	Feb. 7	Mar. 3	Mar. 19	Apr. 24	May 10	June 1	July 21	Dec. 31
$p$	0·2	0·3	0·4	0·5	0·4	0·3	0·2	0·1	0·0
$k$	0·1	0·2	0·3	0·4	0·3	0·2	0·1	0·0	0·0



## EXPLANATION

The corrections given on page A2, and on the bookmark, are mean values applicable, in the case of Venus, only when the Sun is below the horizon. For daylight observations of Venus the observed values of  $H$  and  $\theta$  should be used to calculate the correction directly; the term  $-k \cos \theta$  is positive when the Sun is lower than Venus, zero when they have the same altitude, and negative when the Sun is higher.

In the case of the Moon the correction table includes the effects of semi-diameter, parallax and augmentation as well as the mean refraction; no correction for irradiation is included.

17. *Bubble sextant observations.* When observing with a bubble sextant no correction is necessary for dip, semi-diameter, or augmentation. For the stars and planets the corrections given may be used unchanged, and they should also be used for the Sun; for the Moon it is easiest to take the mean of the corrections for lower and upper limbs and subtract  $15'$  from the altitude; the correction for dip must not be applied.

## AUXILIARY AND PLANNING DATA

18. *Sun and Moon.* On the daily pages are given: the semi-diameters and the times of meridian passage of both Sun and Moon over the Greenwich meridian; the equation of time; the horizontal parallax and the age of the Moon, together with a symbol indicating the phase. For the Moon, the semi-diameters for each of the three days are given, in order, at the foot of the column; for the Sun a single value is sufficient. The equation of time is given, without sign, for  $00^h$  and  $12^h$  G.M.T. on each day. To obtain apparent time, apply the equation of time to mean time with a *positive* sign when G.H.A. Sun at  $00^h$  G.M.T. *exceeds*  $180^\circ$ , or at  $12^h$  *exceeds*  $0^\circ$ , corresponding to a meridian passage of the Sun *before*  $12^h$  G.M.T.; *otherwise* apply with a *negative* sign.

The times of the phases of the Moon are given in G.M.T. on page 4.

19. *Planets.* The magnitudes of the planets are given immediately following their names in the headings on the daily pages; also given, for the middle day of the three on the page, are their S.H.A. at  $00^h$  G.M.T. and their times of meridian passage.

The planet notes and diagram on pages 8 and 9 provide descriptive information as to the suitability of the planets for observation during the year, and of their positions and movements.

20. *Stars.* The time of meridian passage of the first point of Aries over the Greenwich meridian is given on the daily pages, for the middle day of the three on the page, to  $0^m.1$ . The interval between successive meridian passages is  $23^h 56^m.1$  ( $24^h$  less  $3^m.9$ ) so that times for intermediate days and other meridians can readily be derived. If a precise time is required it may be obtained by finding the G.M.T. at which L.H.A. Aries is zero.

The meridian passage of a star occurs when its L.H.A. is zero, that is when  $L.H.A. Aries + S.H.A. = 360^\circ$ . An approximate time can be obtained from the planet diagram on page 9.

The star charts on pages 266 and 267 are intended to assist identification. They show the relative positions of the stars in the sky as seen from the Earth and include all 173 stars used in the Almanac, together with a few others to complete the main constellation configurations. The local meridian at any time may be located on the chart by means of its S.H.A. which is  $360^\circ - L.H.A. Aries$ , or west longitude  $- G.H.A. Aries$ .

21. *Star globe.* To set a star globe on which is printed a scale of L.H.A. Aries, first set the globe for latitude and then rotate about the polar axis until the scale under the edge of the meridian circle reads L.H.A. Aries.

To mark the positions of the Sun, Moon, and planets on the star globe, take the difference  $G.H.A. Aries - G.H.A. body$  and use this along the L.H.A. Aries scale, in conjunction with the declination, to plot the position.  $G.H.A. Aries - G.H.A. body$  is most conveniently found by taking the difference when the G.H.A. of the body is small (less than  $15^\circ$ ), which happens once a day.

22. *Calendar.* On page 4 are given lists of ecclesiastical festivals, and of the principal anniversaries and holidays in the British Commonwealth and the United States of America. The calendar on page 5 includes the day of the year as well as the day of the week.

## EXPLANATION

Brief particulars are given, at the foot of page 5, of the solar and lunar eclipses occurring during the year; the times given are in G.M.T. The principal features of the more important solar eclipses are shown on the maps on pages 6 and 7.

23. *Standard times.* The lists on pages 262-265 give the standard times used in most countries. In general no attempt is made to give details of the beginning and end of summer time, since they are liable to frequent changes at short notice.

The Date or Calendar Line is an arbitrary line, on either side of which the date differs by one day; when crossing this line on a westerly course, the date must be advanced one day; when crossing it on an easterly course, the date must be put back one day. The line is a modification of the line of the 180th meridian, and is drawn so as to include, as far as possible, islands of any one group, etc., on the same side of the line. It may be traced by starting at the South Pole and joining up to the following positions:

Lat.	S. 51°0	S. 45°0	S. 15°0	S. 5°0	N. 48°0	N. 53°0	N. 65°5
Long.	180°0	W. 172°5	W. 172°5	180°0	180°0	E. 170°0	W. 169°0

thence through the middle of the Diomed Islands to Lat. N.68°0, Long. W.169°0, passing east of Ostrov Vrangelya (Wrangel Island) to Lat. N.75°0, Long. 180°0, and thence to the North Pole.

## ACCURACY

24. *Main data.* The quantities tabulated in this Almanac are generally correct to the nearest 0'1; the exception is the Sun's G.H.A. which is deliberately adjusted by up to 0'15 to reduce the error due to ignoring the  $v$ -correction. The G.H.A. and Dec. at intermediate times cannot be obtained to this precision, since at least two quantities must be added; moreover, the  $v$ - and  $d$ -corrections are based on mean values of  $v$  and  $d$  and are taken from tables for the whole minute only. The largest error that can occur in the G.H.A. or Dec. of any body other than the Sun or Moon is less than 0'2; it may reach 0'25 for the G.H.A. of the Sun and 0'3 for that of the Moon.

In practice it may be expected that only one third of the values of G.H.A. and Dec. taken out will have errors larger than 0'05 and less than one-tenth will have errors larger than 0'1.

25. *Altitude corrections.* The errors in the altitude corrections are nominally of the same order as those in G.H.A. and Dec., as they result from the addition of several quantities each correctly rounded off to 0'1. But the actual values of the dip and of the refraction at low altitudes may, in extreme atmospheric conditions, differ considerably from the mean values used in the tables.

## USE OF THIS ALMANAC IN 1978

This Almanac may be used for the Sun and stars in 1978 in the following manner.

For the Sun, take out the G.H.A. and Dec. for the same date but for a time 5<sup>h</sup> 48<sup>m</sup> 00<sup>s</sup> earlier than the G.M.T. of observation; add 87°00' to the G.H.A. so obtained. The error, mainly due to planetary perturbations of the Earth, is unlikely to exceed 0'4.

For the stars, calculate the G.H.A. and Dec. for the same date and the same time, but subtract 15'1 from the G.H.A. so found. The error, due to incomplete correction for precession and nutation, is unlikely to exceed 0'4. If preferred, the same result can be obtained by using a time 5<sup>h</sup> 48<sup>m</sup> 00<sup>s</sup> earlier than the G.M.T. of observation (as for the Sun) and adding 86°59'2 to the G.H.A. (or adding 87° as for the Sun and subtracting 0'8, for precession, from the S.H.A. of the star).

The Almanac cannot be so used for the Moon or planets.

# ALTITUDE CORRECTION TABLES 10°-90°—SUN, STARS, PLANETS

OCT.—MAR. SUN			APR.—SEPT.			STARS AND PLANETS				DIP			
App. Alt.	Lower Limb	Upper Limb	App. Alt.	Lower Limb	Upper Limb	App. Alt.	Corr <sup>n</sup>	App. Alt.	Additional Corr <sup>n</sup>	Ht. of Eye	Corr <sup>n</sup>	Ht. of Eye	Corr <sup>n</sup>
								1977		m		ft.	m
9 34	+10.8-21.5		9 39	+10.6-21.2		9 56	-5.3	<b>VENUS</b>		2.4	-2.8	8.0	1.0-1.8
9 45	+10.9-21.4		9 51	+10.7-21.1		10 08	-5.2	Jan. 1-Jan. 29		2.6	-2.9	8.6	1.5-2.2
9 56	+11.0-21.3		10 03	+10.8-21.0		10 20	-5.1	0		2.8	-3.0	9.2	2.0-2.5
10 08	+11.1-21.2		10 15	+10.9-20.9		10 33	-5.0	47 + 0.2		3.0	-3.1	9.8	2.5-2.8
10 21	+11.2-21.1		10 27	+11.0-20.8		10 46	-4.9	Jan. 30-Feb. 26		3.2	-3.2	10.5	3.0-3.0
10 34	+11.3-21.0		10 40	+11.1-20.7		11 00	-4.8	0		3.4	-3.3	11.2	See table
10 47	+11.4-20.9		10 54	+11.2-20.6		11 14	-4.7	46 + 0.3		3.6	-3.4	11.9	-
11 01	+11.5-20.8		11 08	+11.3-20.5		11 29	-4.6	Feb. 27-Mar. 14		3.8	-3.5	12.6	m
11 15	+11.6-20.7		11 23	+11.4-20.4		11 45	-4.5	0		4.0	-3.6	13.3	-
11 30	+11.7-20.6		11 38	+11.5-20.3		12 01	-4.4	11 + 0.4		4.3	-3.7	14.1	20-7.9
11 46	+11.8-20.5		11 54	+11.6-20.2		12 18	-4.3	41 + 0.5		4.5	-3.8	14.9	22-8.3
12 02	+11.9-20.4		12 10	+11.7-20.1		12 35	-4.2	Mar. 15-Mar. 23		4.7	-3.9	15.7	24-8.6
12 19	+12.0-20.3		12 28	+11.8-20.0		12 54	-4.1	0		5.0	-4.0	16.5	26-9.0
12 37	+12.1-20.2		12 46	+11.9-19.9		13 13	-4.0	6 + 0.5		5.2	-4.1	17.4	28-9.3
12 55	+12.2-20.1		13 05	+12.0-19.8		13 33	-3.9	20 + 0.6		5.5	-4.2	18.3	30-9.6
13 14	+12.3-20.0		13 24	+12.1-19.7		13 54	-3.8	31 + 0.7		5.8	-4.3	19.1	32-10.0
13 35	+12.4-19.9		13 45	+12.2-19.6		14 16	-3.7	Mar. 24-Apr. 19		6.1	-4.4	20.1	34-10.3
13 56	+12.5-19.8		14 07	+12.3-19.5		14 40	-3.6	0		6.3	-4.5	21.0	36-10.6
14 18	+12.6-19.7		14 30	+12.4-19.4		15 04	-3.5	4 + 0.6		6.6	-4.6	22.0	38-10.8
14 42	+12.7-19.6		14 54	+12.5-19.3		15 30	-3.4	12 + 0.7		6.9	-4.7	22.9	-
15 06	+12.8-19.5		15 19	+12.6-19.2		15 57	-3.3	22 + 0.8		7.2	-4.8	23.9	40-11.1
15 32	+12.9-19.4		15 46	+12.7-19.1		16 26	-3.2	Apr. 20-Apr. 28		7.5	-4.9	24.9	42-11.4
15 59	+13.0-19.3		16 14	+12.8-19.0		16 56	-3.1	0		7.9	-5.0	26.0	44-11.7
16 28	+13.1-19.2		16 44	+12.9-18.9		17 28	-3.0	6 + 0.5		8.2	-5.1	27.1	46-11.9
16 59	+13.2-19.1		17 15	+13.0-18.8		18 02	-2.9	20 + 0.6		8.5	-5.2	28.1	48-12.2
17 32	+13.3-19.0		17 48	+13.1-18.7		18 38	-2.8	31 + 0.7		8.8	-5.3	29.2	ft.
18 06	+13.4-18.9		18 24	+13.2-18.6		19 17	-2.7	Apr. 29-May 13		9.2	-5.4	30.4	2 1.4
18 42	+13.5-18.8		19 01	+13.3-18.5		19 58	-2.6	0		9.5	-5.5	31.5	4 1.9
19 21	+13.6-18.7		19 42	+13.4-18.4		20 42	-2.5	11 + 0.4		9.9	-5.6	32.7	6 2.4
20 03	+13.7-18.6		20 25	+13.5-18.3		21 28	-2.4	41 + 0.5		10.3	-5.7	33.9	8 2.7
20 48	+13.8-18.5		21 11	+13.6-18.2		22 19	-2.3	May 14-June 8		10.6	-5.8	35.1	10 3.1
21 35	+13.9-18.4		22 00	+13.7-18.1		23 13	-2.2	0		11.0	-5.9	36.3	See table
22 26	+14.0-18.3		22 54	+13.8-18.0		24 11	-2.1	46 + 0.3		11.4	-6.0	37.6	-
23 22	+14.1-18.2		23 51	+13.9-17.9		25 14	-2.0	Jun. 9-July 23		11.8	-6.1	38.9	ft.
24 21	+14.2-18.1		24 53	+14.0-17.8		26 22	-1.9	0		12.2	-6.2	40.1	70 8.1
25 26	+14.3-18.0		26 00	+14.1-17.7		27 36	-1.8	47 + 0.2		12.6	-6.3	41.5	75 8.4
26 36	+14.4-17.9		27 13	+14.2-17.6		28 56	-1.7	Jul. 24-Dec. 31		13.0	-6.4	42.8	80 8.7
27 52	+14.5-17.8		28 33	+14.3-17.5		30 24	-1.6	0		13.4	-6.5	44.2	85 8.9
29 15	+14.6-17.7		30 00	+14.4-17.4		32 00	-1.5	42 + 0.1		13.8	-6.6	45.5	90 9.2
30 46	+14.7-17.6		31 35	+14.5-17.3		33 45	-1.4	May 14-June 8		14.2	-6.7	46.9	95 9.5
32 26	+14.8-17.5		33 20	+14.6-17.2		35 40	-1.3	0		14.7	-6.8	48.4	-
34 17	+14.9-17.4		35 17	+14.7-17.1		37 48	-1.2	42 + 0.1		15.1	-6.9	49.8	ft.
36 20	+15.0-17.3		37 26	+14.8-17.0		40 08	-1.1	Jun. 9-July 23		15.5	-7.0	51.3	100 9.7
38 36	+15.1-17.2		39 50	+14.9-16.9		42 44	-1.0	0		16.0	-7.1	52.8	105 9.9
41 08	+15.2-17.1		42 31	+15.0-16.8		45 36	-0.9	Jan. 1-Nov. 12		16.5	-7.2	54.3	110 10.2
43 59	+15.3-17.0		45 31	+15.1-16.7		48 47	-0.8	0		16.9	-7.3	55.8	115 10.4
47 10	+15.4-16.9		48 55	+15.2-16.6		52 18	-0.8	60 + 0.1		17.4	-7.4	57.4	120 10.6
50 46	+15.5-16.8		52 44	+15.3-16.5		56 11	-0.7	Nov. 13-Dec. 31		17.9	-7.5	58.9	125 10.8
54 49	+15.6-16.7		57 02	+15.4-16.4		60 28	-0.6	0		18.4	-7.6	60.5	-
59 23	+15.7-16.6		61 51	+15.5-16.3		65 08	-0.5	41 + 0.2		18.8	-7.7	62.1	130 11.1
64 30	+15.8-16.5		67 17	+15.6-16.2		70 11	-0.4	75 + 0.1		19.3	-7.8	63.8	135 11.3
70 12	+15.9-16.4		73 16	+15.7-16.1		75 34	-0.3	-		19.8	-7.9	65.4	140 11.5
76 26	+16.0-16.3		79 43	+15.8-16.0		81 13	-0.2	-		20.4	-8.0	67.1	145 11.7
83 05	+16.1-16.2		86 32	+15.9-15.9		87 03	-0.1	-		20.9	-8.1	68.8	150 11.9
90 00			90 00			90 00	0.0	-		21.4	-8.1	70.5	155 12.1

App. Alt.    Apparent altitude    Sextant altitude corrected for index error and dip.  
For daylight observations of Venus, see page 260.

# ALTITUDE CORRECTION TABLES 0°-10°-SUN, STARS, PLANETS A3

App. Alt.	OCT.-MAR. SUN		APR.-SEPT.		STARS PLANETS
	Lower Limb	Upper Limb	Lower Limb	Upper Limb	
0 00	-18.2	-50.5	-18.4	-50.2	-34.5
03	17.5	49.8	17.8	49.6	33.8
06	16.9	49.2	17.1	48.9	33.2
09	16.3	48.6	16.5	48.3	32.6
12	15.7	48.0	15.9	47.7	32.0
15	15.1	47.4	15.3	47.1	31.4
0 18	-14.5	-46.8	-14.8	-46.6	-30.8
21	14.0	46.3	14.2	46.0	30.3
24	13.5	45.8	13.7	45.5	29.8
27	12.9	45.2	13.2	45.0	29.2
30	12.4	44.7	12.7	44.5	28.7
33	11.9	44.2	12.2	44.0	28.2
0 36	-11.5	-43.8	-11.7	-43.5	-27.8
39	11.0	43.3	11.2	43.0	27.3
42	10.5	42.8	10.8	42.6	26.8
45	10.1	42.4	10.3	42.1	26.4
48	9.6	41.9	9.9	41.7	25.9
51	9.2	41.5	9.5	41.3	25.5
0 54	-8.8	-41.1	-9.1	-40.9	-25.1
0 57	8.4	40.7	8.7	40.5	24.7
1 00	8.0	40.3	8.3	40.1	24.3
03	7.7	40.0	7.9	39.7	24.0
06	7.3	39.6	7.5	39.3	23.6
09	6.9	39.2	7.2	39.0	23.2
1 12	-6.6	-38.9	-6.8	-38.6	-22.9
15	6.2	38.5	6.5	38.3	22.5
18	5.9	38.2	6.2	38.0	22.2
21	5.6	37.9	5.8	37.6	21.9
24	5.3	37.6	5.5	37.3	21.6
27	4.9	37.2	5.2	37.0	21.2
1 30	-4.6	-36.9	-4.9	-36.7	-20.9
35	4.2	36.5	4.4	36.2	20.5
40	3.7	36.0	4.0	35.8	20.0
45	3.2	35.5	3.5	35.3	19.5
50	2.8	35.1	3.1	34.9	19.1
1 55	2.4	34.7	2.6	34.4	18.7
2 00	-2.0	-34.3	-2.2	-34.0	-18.3
05	1.6	33.9	1.8	33.6	17.9
10	1.2	33.5	1.5	33.3	17.5
15	0.9	33.2	1.1	32.9	17.2
20	0.5	32.8	0.8	32.6	16.8
25	-0.2	32.5	0.4	32.2	16.5
2 30	+0.2	-32.1	-0.1	-31.9	-16.1
35	0.5	31.8	0.2	31.6	15.8
40	0.8	31.5	0.5	31.3	15.5
45	1.1	31.2	0.8	31.0	15.2
50	1.4	30.9	1.1	30.7	14.9
2 55	1.6	30.7	1.4	30.4	14.7
3 00	+1.9	-30.4	+1.7	-30.1	-14.4
05	2.2	30.1	1.9	29.9	14.1
10	2.4	29.9	2.1	29.7	13.9
15	2.6	29.7	2.4	29.4	13.7
20	2.9	29.4	2.6	29.2	13.4
25	3.1	29.2	2.9	28.9	13.2
3 30	+3.3	-29.0	+3.1	-28.7	-13.0

App. Alt.	OCT.-MAR. SUN		APR.-SEPT.		STARS PLANETS
	Lower Limb	Upper Limb	Lower Limb	Upper Limb	
3 30	+3.3	-29.0	+3.1	-28.7	-13.0
35	3.6	28.7	3.3	28.5	12.7
40	3.8	28.5	3.5	28.3	12.5
45	4.0	28.3	3.7	28.1	12.3
50	4.2	28.1	3.9	27.9	12.1
3 55	4.4	27.9	4.1	27.7	11.9
4 00	+4.5	-27.8	+4.3	-27.5	-11.8
05	4.7	27.6	4.5	27.3	11.6
10	4.9	27.4	4.6	27.2	11.4
15	5.1	27.2	4.8	27.0	11.2
20	5.2	27.1	5.0	26.8	11.1
25	5.4	26.9	5.1	26.7	10.9
4 30	+5.6	-26.7	+5.3	-26.5	-10.7
35	5.7	26.6	5.5	26.3	10.6
40	5.9	26.4	5.6	26.2	10.4
45	6.0	26.3	5.8	26.0	10.3
50	6.2	26.1	5.9	25.9	10.1
4 55	6.3	26.0	6.0	25.8	10.0
5 00	+6.4	-25.9	+6.2	-25.6	-9.9
05	6.6	25.7	6.3	25.5	9.7
10	6.7	25.6	6.4	25.4	9.6
15	6.8	25.5	6.6	25.2	9.5
20	6.9	25.4	6.7	25.1	9.4
25	7.1	25.2	6.8	25.0	9.2
5 30	+7.2	-25.1	+6.9	-24.9	-9.1
35	7.3	25.0	7.0	24.8	9.0
40	7.4	24.9	7.2	24.6	8.9
45	7.5	24.8	7.3	24.5	8.8
50	7.6	24.7	7.4	24.4	8.7
5 55	7.7	24.6	7.5	24.3	8.6
6 00	+7.8	-24.5	+7.6	-24.2	-8.5
10	8.0	24.3	7.8	24.0	8.3
20	8.2	24.1	8.0	23.8	8.1
30	8.4	23.9	8.1	23.7	7.9
40	8.6	23.7	8.3	23.5	7.7
6 50	8.7	23.6	8.5	23.3	7.6
7 00	+8.9	-23.4	+8.6	-23.2	-7.4
10	9.1	23.2	8.8	23.0	7.2
20	9.2	23.1	9.0	22.8	7.1
30	9.3	23.0	9.1	22.7	7.0
40	9.5	22.8	9.2	22.6	6.8
7 50	9.6	22.7	9.4	22.4	6.7
8 00	+9.7	-22.6	+9.5	-22.3	-6.6
10	9.9	22.4	9.6	22.2	6.4
20	10.0	22.3	9.7	22.1	6.3
30	10.1	22.2	9.8	22.0	6.2
40	10.2	22.1	10.0	21.8	6.1
8 50	10.3	22.0	10.1	21.7	6.0
9 00	+10.4	-21.9	+10.2	-21.6	-5.9
10	10.5	21.8	10.3	21.5	5.8
20	10.6	21.7	10.4	21.4	5.7
30	10.7	21.6	10.5	21.3	5.6
40	10.8	21.5	10.6	21.2	5.5
9 50	10.9	21.4	10.6	21.2	5.4
10 00	+11.0	-21.3	+10.7	-21.1	-5.3

Additional corrections for temperature and pressure are given on the following page.  
For bubble sextant observations ignore dip and use the star corrections for Sun, planets, and stars.

# A4 ALTITUDE CORRECTION TABLES—ADDITIONAL CORRECTIONS

## ADDITIONAL REFRACTION CORRECTIONS FOR NON-STANDARD CONDITIONS

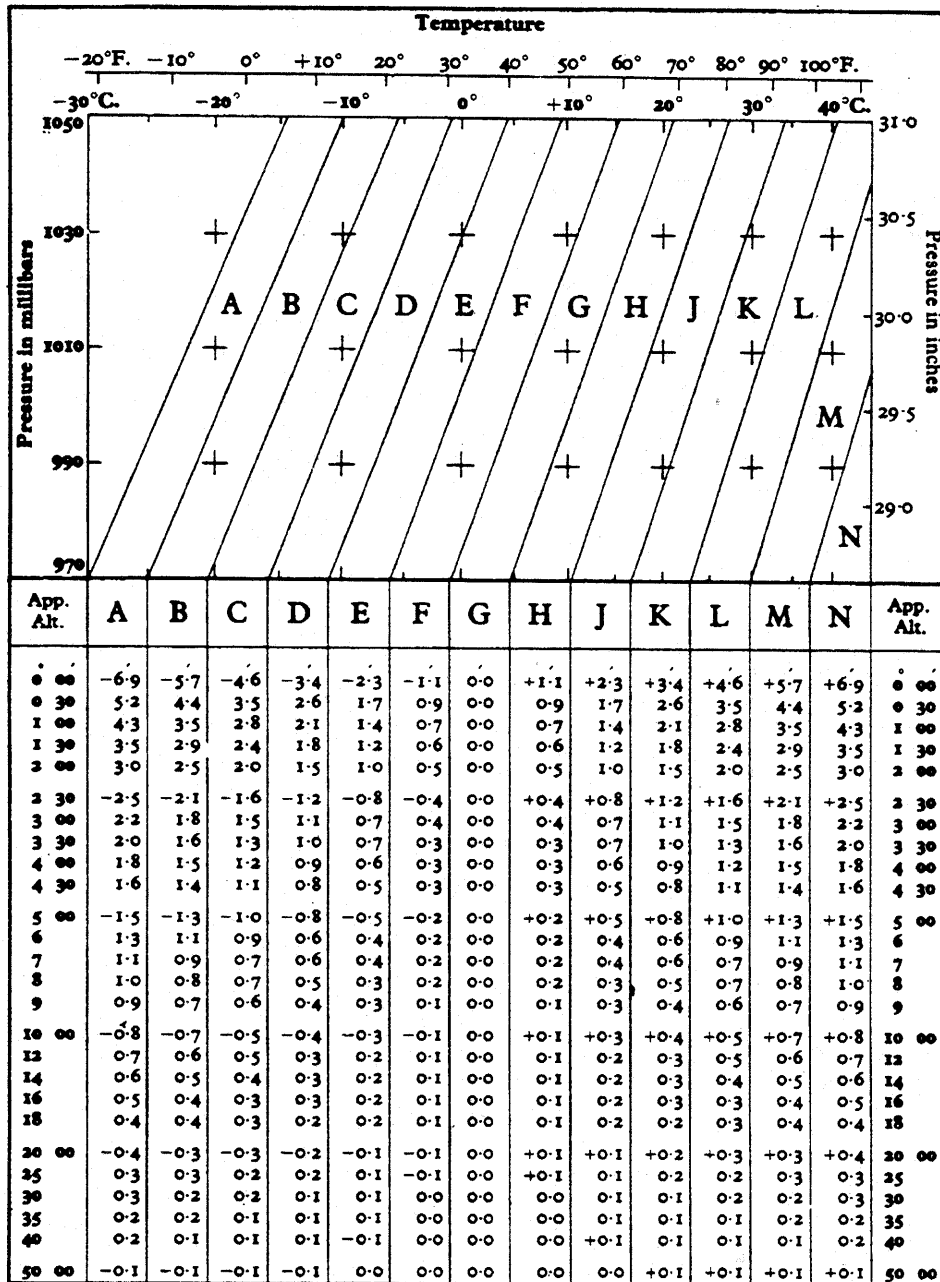

The graph is entered with arguments temperature and pressure to find a zone letter; using as arguments this zone letter and apparent altitude (sextant altitude corrected for dip), a correction is taken from the table. This correction is to be applied to the sextant altitude in addition to the corrections for standard conditions (for the Sun, stars and planets from page A2 and for the Moon from pages xxxiv and xxxv).

## ALTITUDE CORRECTION TABLES 0°-35°-MOON

App. Alt.	0°-4°	5°-9°	10°-14°	15°-19°	20°-24°	25°-29°	30°-34°	App. Alt.							
	Corr <sup>a</sup>	Corr <sup>a</sup>	Corr <sup>a</sup>	Corr <sup>a</sup>	Corr <sup>a</sup>	Corr <sup>a</sup>	Corr <sup>a</sup>								
00	33.8	58.2	62.1	62.8	62.2	60.8	58.9	00							
10	35.9	58.5	62.2	62.8	62.1	60.8	58.8	10							
20	37.8	58.7	62.2	62.8	62.1	60.7	58.8	20							
30	39.6	58.9	62.3	62.8	62.1	60.7	58.7	30							
40	41.2	59.1	62.3	62.8	62.0	60.6	58.6	40							
50	42.6	59.3	62.4	62.7	62.0	60.6	58.5	50							
00	44.0	59.5	62.4	62.7	62.0	60.5	58.5	00							
10	45.2	59.7	62.4	62.7	61.9	60.4	58.4	10							
20	46.3	59.9	62.5	62.7	61.9	60.4	58.3	20							
30	47.3	60.0	62.5	62.7	61.9	60.3	58.2	30							
40	48.3	60.2	62.5	62.7	61.8	60.3	58.2	40							
50	49.2	60.3	62.6	62.7	61.8	60.2	58.1	50							
00	50.0	60.5	62.6	62.7	61.7	60.1	58.0	00							
10	50.8	60.6	62.6	62.6	61.7	60.1	57.9	10							
20	51.4	60.7	62.6	62.6	61.6	60.0	57.8	20							
30	52.1	60.9	62.7	62.6	61.6	59.9	57.8	30							
40	52.7	61.0	62.7	62.6	61.5	59.9	57.7	40							
50	53.3	61.1	62.7	62.6	61.5	59.8	57.6	50							
00	53.8	61.2	62.7	62.5	61.5	59.7	57.5	00							
10	54.3	61.3	62.7	62.5	61.4	59.7	57.4	10							
20	54.8	61.4	62.7	62.5	61.4	59.6	57.4	20							
30	55.2	61.5	62.8	62.5	61.3	59.6	57.3	30							
40	55.6	61.6	62.8	62.4	61.3	59.5	57.2	40							
50	56.0	61.6	62.8	62.4	61.2	59.4	57.1	50							
00	56.4	61.7	62.8	62.4	61.2	59.3	57.0	00							
10	56.7	61.8	62.8	62.3	61.1	59.3	56.9	10							
20	57.1	61.9	62.8	62.3	61.1	59.2	56.9	20							
30	57.4	61.9	62.8	62.3	61.0	59.1	56.8	30							
40	57.7	62.0	62.8	62.2	60.9	59.1	56.7	40							
50	57.9	62.1	62.8	62.2	60.9	59.0	56.6	50							
H.P.	L	U	L	U	L	U	L	U	H.P.						
54.0	0.3	0.9	0.3	0.9	0.4	1.0	0.5	1.1	0.6	1.2	0.7	1.3	0.9	1.5	54.0
54.3	0.7	1.1	0.7	1.2	0.8	1.3	0.9	1.4	1.1	1.5	1.2	1.7	1.2	1.7	54.3
54.6	1.1	1.4	1.1	1.4	1.2	1.5	1.3	1.6	1.4	1.7	1.5	1.8	1.5	1.8	54.6
54.9	1.4	1.6	1.5	1.6	1.6	1.7	1.6	1.8	1.8	1.9	1.9	2.0	1.9	2.0	54.9
55.2	1.8	1.8	1.8	1.8	1.9	1.9	1.9	1.9	2.0	2.0	2.1	2.1	2.2	2.2	55.2
55.5	2.2	2.0	2.2	2.0	2.3	2.1	2.3	2.1	2.4	2.2	2.4	2.3	2.5	2.4	55.5
55.8	2.6	2.2	2.6	2.2	2.7	2.3	2.7	2.4	2.8	2.4	2.9	2.5	2.9	2.5	55.8
56.1	3.0	2.4	3.0	2.5	3.0	2.5	3.0	2.5	3.1	2.6	3.1	2.6	3.2	2.7	56.1
56.4	3.4	2.7	3.4	2.7	3.4	2.7	3.4	2.8	3.5	2.8	3.5	2.9	3.5	2.9	56.4
56.7	3.7	2.9	3.7	2.9	3.8	2.9	3.8	3.0	3.8	3.0	3.9	3.0	3.9	3.0	56.7
57.0	4.1	3.1	4.1	3.1	4.1	3.1	4.2	3.1	4.2	3.2	4.2	3.2	4.2	3.2	57.0
57.3	4.5	3.3	4.5	3.3	4.5	3.3	4.5	3.3	4.5	3.4	4.6	3.4	4.6	3.4	57.3
57.6	4.9	3.5	4.9	3.5	4.9	3.5	4.9	3.5	4.9	3.5	4.9	3.6	4.9	3.6	57.6
57.9	5.3	3.8	5.3	3.8	5.2	3.8	5.2	3.7	5.2	3.7	5.2	3.7	5.2	3.7	57.9
58.2	5.6	4.0	5.6	4.0	5.6	4.0	5.6	3.9	5.6	3.9	5.6	3.9	5.6	3.9	58.2
58.5	6.0	4.2	6.0	4.2	6.0	4.2	6.0	4.1	5.9	4.1	5.9	4.1	5.8	4.1	58.5
58.8	6.4	4.4	6.4	4.4	6.3	4.4	6.3	4.3	6.3	4.3	6.2	4.2	6.2	4.2	58.8
59.1	6.8	4.6	6.8	4.6	6.7	4.6	6.7	4.5	6.6	4.5	6.6	4.4	6.6	4.4	59.1
59.4	7.2	4.8	7.1	4.8	7.1	4.8	7.0	4.7	7.0	4.7	6.9	4.6	6.9	4.6	59.4
59.7	7.5	5.1	7.5	5.0	7.5	5.0	7.4	4.9	7.3	4.8	7.2	4.7	7.2	4.7	59.7
60.0	7.9	5.3	7.9	5.2	7.8	5.2	7.8	5.1	7.7	5.0	7.6	4.9	7.6	4.9	60.0
60.3	8.3	5.5	8.3	5.4	8.2	5.4	8.1	5.3	8.0	5.2	7.9	5.1	7.9	5.1	60.3
60.6	8.7	5.7	8.7	5.7	8.6	5.6	8.5	5.5	8.4	5.4	8.2	5.3	8.2	5.3	60.6
60.9	9.1	5.9	9.0	5.9	8.9	5.8	8.8	5.7	8.7	5.6	8.6	5.4	8.6	5.4	60.9
61.2	9.5	6.2	9.4	6.1	9.3	6.0	9.2	5.9	9.1	5.8	8.9	5.6	8.9	5.6	61.2
61.5	9.8	6.4	9.8	6.3	9.7	6.2	9.6	6.1	9.4	5.9	9.2	5.8	9.2	5.8	61.5

DIP			
Ht. of Eye	Corr <sup>n</sup>	Ht. of Eye	Ht. of Eye
m	ft.	m	ft.
2.4	-2.8	8.0	9.5
2.6	-2.9	8.6	9.9
2.8	-3.0	9.2	10.3
3.0	-3.1	9.8	10.6
3.2	-3.2	10.5	11.0
3.4	-3.3	11.2	11.4
3.6	-3.4	11.9	11.8
3.8	-3.5	12.6	12.2
4.0	-3.6	13.3	12.6
4.3	-3.7	14.1	13.0
4.5	-3.8	14.9	13.4
4.7	-3.9	15.7	13.8
5.0	-4.0	16.5	14.2
5.2	-4.1	17.4	14.7
5.5	-4.2	18.3	15.1
5.8	-4.3	19.1	15.5
6.1	-4.4	20.1	16.0
6.3	-4.4	21.0	16.5
6.6	-4.5	22.0	16.9
6.9	-4.6	22.9	17.4
7.2	-4.7	23.9	17.9
7.5	-4.8	24.9	18.4
7.9	-5.0	26.0	18.8
8.2	-5.1	27.1	19.3
8.5	-5.2	28.1	19.8
8.8	-5.3	29.2	20.4
9.2	-5.4	30.4	20.9
9.5	-5.4	31.5	21.4

### MOON CORRECTION TABLE

The correction is in two parts; the first correction is taken from the upper part of the table with argument apparent altitude, and the second from the lower part, with argument H.P., in the same column as that from which the first correction was taken. Separate corrections are given in the lower part for lower (L) and upper (U) limbs. All corrections are to be added to apparent altitude, but 30' is to be subtracted from the altitude of the upper limb.

For corrections for pressure and temperature see page A4.

For bubble sextant observations ignore dip, take the mean of upper and lower limb corrections and subtract 15' from the altitude.

App. Alt. = Apparent altitude  
 = Sextant altitude corrected for index error and dip.

ALTITUDE CORRECTION TABLES 35°-90°—MOON

App. Alt.	35°-39°	40°-44°	45°-49°	50°-54°	55°-59°	60°-64°	65°-69°	70°-74°	75°-79°	80°-84°	85°-89°	App. Alt.
	Corr <sup>a</sup>	Corr <sup>a</sup>	Corr <sup>a</sup>	Corr <sup>a</sup>	Corr <sup>a</sup>	Corr <sup>a</sup>	Corr <sup>a</sup>	Corr <sup>a</sup>	Corr <sup>a</sup>	Corr <sup>a</sup>	Corr <sup>a</sup>	
00	35 56.5	40 53.7	45 50.5	50 46.9	55 43.1	60 38.9	65 34.6	70 30.1	75 25.3	80 20.5	85 15.6	00
10	56.4	53.6	50.4	46.8	42.9	38.8	34.4	29.9	25.2	20.4	15.5	10
20	56.3	53.5	50.2	46.7	42.8	38.7	34.3	29.7	25.0	20.2	15.3	20
30	56.2	53.4	50.1	46.5	42.7	38.5	34.1	29.6	24.9	20.0	15.1	30
40	56.2	53.3	50.0	46.4	42.5	38.4	34.0	29.4	24.7	19.9	15.0	40
50	56.1	53.2	49.9	46.3	42.4	38.2	33.8	29.3	24.5	19.7	14.8	50
00	36 56.0	41 53.1	46 49.8	51 46.2	56 42.3	61 38.1	66 33.7	71 29.1	76 24.4	81 19.6	86 14.6	00
10	55.9	53.0	49.7	46.0	42.1	37.9	33.5	29.0	24.2	19.4	14.5	10
20	55.8	52.8	49.5	45.9	42.0	37.8	33.4	28.8	24.1	19.2	14.3	20
30	55.7	52.7	49.4	45.8	41.8	37.7	33.2	28.7	23.9	19.1	14.1	30
40	55.6	52.6	49.3	45.7	41.7	37.5	33.1	28.5	23.8	18.9	14.0	40
50	55.5	52.5	49.2	45.5	41.6	37.4	32.9	28.3	23.6	18.7	13.8	50
00	37 55.4	42 52.4	47 49.1	52 45.4	57 41.4	62 37.2	67 32.8	72 28.2	77 23.4	82 18.6	87 13.7	00
10	55.3	52.3	49.0	45.3	41.3	37.1	32.6	28.0	23.3	18.4	13.5	10
20	55.2	52.2	48.8	45.2	41.2	36.9	32.5	27.9	23.1	18.2	13.3	20
30	55.1	52.1	48.7	45.0	41.0	36.8	32.3	27.7	22.9	18.1	13.2	30
40	55.0	52.0	48.6	44.9	40.9	36.6	32.2	27.6	22.8	17.9	13.0	40
50	55.0	51.9	48.5	44.8	40.8	36.5	32.0	27.4	22.6	17.8	12.8	50
00	38 54.9	43 51.8	48 48.4	53 44.6	58 40.6	63 36.4	68 31.9	73 27.2	78 22.5	83 17.6	88 12.7	00
10	54.8	51.7	48.2	44.5	40.5	36.2	31.7	27.1	22.3	17.4	12.5	10
20	54.7	51.6	48.1	44.4	40.3	36.1	31.6	26.9	22.1	17.3	12.3	20
30	54.6	51.5	48.0	44.2	40.2	35.9	31.4	26.8	22.0	17.1	12.2	30
40	54.5	51.4	47.9	44.1	40.1	35.8	31.3	26.6	21.8	16.9	12.0	40
50	54.4	51.2	47.8	44.0	39.9	35.6	31.1	26.5	21.7	16.8	11.8	50
00	39 54.3	44 51.1	49 47.6	54 43.9	59 39.8	64 35.5	69 31.0	74 26.3	79 21.5	84 16.6	89 11.7	00
10	54.2	51.0	47.5	43.7	39.6	35.3	30.8	26.1	21.3	16.5	11.5	10
20	54.1	50.9	47.4	43.6	39.5	35.2	30.7	26.0	21.2	16.3	11.4	20
30	54.0	50.8	47.3	43.5	39.4	35.0	30.5	25.8	21.0	16.1	11.2	30
40	53.9	50.7	47.2	43.3	39.2	34.9	30.4	25.7	20.9	16.0	11.0	40
50	53.8	50.6	47.0	43.2	39.1	34.7	30.2	25.5	20.7	15.8	10.9	50
H.P.	L U	L U	L U	L U	L U	L U	L U	L U	L U	L U	L U	H.P.
54.0	1.1 1.7	1.3 1.9	1.5 2.1	1.7 2.4	2.0 2.6	2.3 2.9	2.6 3.2	2.9 3.5	3.2 3.8	3.5 4.1	3.8 4.5	54.0
54.3	1.4 1.8	1.6 2.0	1.8 2.2	2.0 2.5	2.3 2.7	2.5 3.0	2.8 3.2	3.0 3.5	3.3 3.8	3.6 4.1	3.9 4.4	54.3
54.6	1.7 2.0	1.9 2.2	2.1 2.4	2.3 2.6	2.5 2.8	2.7 3.0	3.0 3.3	3.2 3.5	3.5 3.8	3.7 4.1	4.0 4.3	54.6
54.9	2.0 2.2	2.2 2.3	2.3 2.5	2.5 2.7	2.7 2.9	2.9 3.1	3.2 3.3	3.4 3.5	3.6 3.8	3.9 4.0	4.1 4.3	54.9
55.2	2.3 2.3	2.5 2.4	2.6 2.6	2.8 2.8	3.0 2.9	3.2 3.1	3.4 3.3	3.6 3.5	3.8 3.7	4.0 4.0	4.2 4.2	55.2
55.5	2.7 2.5	2.8 2.6	2.9 2.7	3.1 2.9	3.2 3.0	3.4 3.2	3.6 3.4	3.7 3.5	3.9 3.7	4.1 3.9	4.3 4.1	55.5
55.8	3.0 2.6	3.1 2.7	3.2 2.8	3.3 3.0	3.5 3.1	3.6 3.3	3.8 3.4	3.9 3.6	4.1 3.7	4.2 3.9	4.4 4.0	55.8
56.1	3.3 2.8	3.4 2.9	3.5 3.0	3.6 3.1	3.7 3.2	3.8 3.3	4.0 3.4	4.1 3.6	4.2 3.7	4.4 3.8	4.5 4.0	56.1
56.4	3.6 2.9	3.7 3.0	3.8 3.1	3.9 3.2	3.9 3.3	4.0 3.4	4.1 3.5	4.3 3.6	4.4 3.7	4.5 3.8	4.6 3.9	56.4
56.7	3.9 3.1	4.0 3.1	4.1 3.2	4.1 3.3	4.2 3.3	4.3 3.4	4.3 3.5	4.4 3.6	4.5 3.7	4.6 3.8	4.7 3.8	56.7
57.0	4.3 3.2	4.3 3.3	4.3 3.3	4.4 3.4	4.4 3.4	4.5 3.5	4.5 3.5	4.6 3.6	4.7 3.6	4.7 3.7	4.8 3.8	57.0
57.3	4.6 3.4	4.6 3.4	4.6 3.4	4.6 3.5	4.7 3.5	4.7 3.5	4.7 3.6	4.8 3.6	4.8 3.6	4.8 3.7	4.9 3.7	57.3
57.6	4.9 3.6	4.9 3.6	4.9 3.6	4.9 3.6	4.9 3.6	4.9 3.6	4.9 3.6	4.9 3.6	5.0 3.6	5.0 3.6	5.0 3.6	57.6
57.9	5.2 3.7	5.2 3.7	5.2 3.7	5.2 3.7	5.2 3.7	5.1 3.6	5.1 3.6	5.1 3.6	5.1 3.6	5.1 3.6	5.1 3.6	57.9
58.2	5.5 3.9	5.5 3.8	5.5 3.8	5.4 3.8	5.4 3.7	5.4 3.7	5.3 3.7	5.3 3.6	5.2 3.6	5.2 3.5	5.2 3.5	58.2
58.5	5.9 4.0	5.8 4.0	5.8 3.9	5.7 3.9	5.6 3.8	5.6 3.8	5.5 3.7	5.5 3.6	5.4 3.6	5.3 3.5	5.3 3.4	58.5
58.8	6.2 4.2	6.1 4.1	6.0 4.1	6.0 4.0	5.9 3.9	5.8 3.8	5.7 3.7	5.6 3.6	5.5 3.5	5.4 3.5	5.3 3.4	58.8
59.1	6.5 4.3	6.4 4.3	6.3 4.2	6.2 4.1	6.1 4.0	6.0 3.9	5.9 3.8	5.8 3.6	5.7 3.5	5.6 3.4	5.4 3.3	59.1
59.4	6.8 4.5	6.7 4.4	6.6 4.3	6.5 4.2	6.4 4.1	6.2 3.9	6.1 3.8	6.0 3.7	5.8 3.5	5.7 3.4	5.5 3.2	59.4
59.7	7.1 4.6	7.0 4.5	6.9 4.4	6.8 4.3	6.6 4.1	6.5 4.0	6.3 3.8	6.2 3.7	6.0 3.5	5.8 3.3	5.6 3.2	59.7
60.0	7.5 4.8	7.3 4.7	7.2 4.5	7.0 4.4	6.9 4.2	6.7 4.0	6.5 3.9	6.3 3.7	6.1 3.5	5.9 3.3	5.7 3.1	60.0
60.3	7.8 5.0	7.6 4.8	7.5 4.7	7.3 4.5	7.1 4.3	6.9 4.1	6.7 3.9	6.5 3.7	6.3 3.5	6.0 3.2	5.8 3.0	60.3
60.6	8.1 5.1	7.9 5.0	7.7 4.8	7.6 4.6	7.3 4.4	7.1 4.2	6.9 3.9	6.7 3.7	6.4 3.4	6.2 3.2	5.9 2.9	60.6
60.9	8.4 5.3	8.2 5.1	8.0 4.9	7.8 4.7	7.6 4.5	7.3 4.2	7.1 4.0	6.8 3.7	6.6 3.4	6.3 3.2	6.0 2.9	60.9
61.2	8.7 5.4	8.5 5.2	8.3 5.0	8.1 4.8	7.8 4.5	7.6 4.3	7.3 4.0	7.0 3.7	6.7 3.4	6.4 3.1	6.1 2.8	61.2
61.5	9.1 5.6	8.8 5.4	8.6 5.1	8.3 4.9	8.1 4.6	7.8 4.3	7.5 4.0	7.2 3.7	6.9 3.4	6.5 3.1	6.2 2.7	61.5

DECEMBER 9, 10, 11 (FRI., SAT., SUN.)

G.M.T.	ARIES			VENUS -3.4			MARS -0.3			JUPITER -2.3			SATURN +0.7			STARS		
	G.H.A.	G.H.A.	Dec.	G.H.A.	Dec.		G.H.A.	Dec.		G.H.A.	Dec.		G.H.A.	Dec.		Name	S.H.A.	Dec.
9 00	77 37.3	193 11.5	S20 44.0	302 51.4	N20 05.7		344 25.9	N23 07.1		284 31.9	N12 31.7					Acomar	315 38.3	S40 23.8
01	92 39.8	208 10.6	44.6	317 53.7	05.8		359 28.7	07.1		299 34.4	31.7					Achernar	335 46.4	S57 21.2
02	107 42.2	223 09.8	45.2	332 56.0	05.9		14 31.5	07.2		314 36.8	31.7					Acruz	173 39.4	S62 58.3
03	122 44.7	238 09.0	45.9	347 58.3	05.9		29 34.3	07.2		329 39.3	31.7					Adhara	255 33.2	S28 56.5
04	137 47.2	253 08.1	46.5	3 00.6	06.0		44 37.1	07.2		344 41.7	31.7					Aidebaran	291 19.8	N16 27.9
05	152 49.6	268 07.3	47.1	18 02.9	06.1		59 39.9	07.2		359 44.2	31.7							
06	167 52.1	283 06.5	S20 47.8	33 05.2	N20 06.1		74 42.7	N23 07.2		14 46.6	N12 31.8					Alioth	166 44.5	N5c 04.5
07	182 54.6	298 05.6	48.4	48 07.5	06.2		89 45.5	07.2		29 49.1	31.8					Alkaid	153 20.4	N49 25.2
08	197 57.0	313 04.8	49.0	63 09.8	06.3		104 48.4	07.2		44 51.5	31.8					Al Na'ir	28 17.5	S47 04.2
F 09	212 59.5	328 04.0	49.6	78 12.2	06.4		119 51.2	07.2		59 54.0	31.8					Alnilam	276 13.2	S 1 13.0
R 10	228 02.0	343 03.1	50.3	93 14.5	06.4		134 54.0	07.3		74 56.4	31.8					Alphard	218 22.2	S 8 33.8
I 11	243 04.4	358 02.3	50.9	108 16.8	06.5		149 56.8	07.3		89 58.9	31.8							
D 12	258 06.9	13 01.5	S20 51.5	123 19.1	N20 06.6		164 59.6	N23 07.3		105 01.3	N12 31.8					Alphecca	125 34.1	N26 47.4
A 13	273 09.4	28 00.6	52.1	138 21.4	06.7		180 02.4	07.3		120 03.8	31.8					Alpheratz	358 11.1	N28 58.3
14	288 11.8	42 59.8	52.7	153 23.8	06.7		195 05.2	07.3		135 06.2	31.8					Altair	62 34.6	N 8 48.8
15	303 14.3	57 59.0	53.4	168 26.1	06.8		210 08.0	07.3		150 08.7	31.8					Ankaa	353 42.0	S42 25.7
16	318 16.7	72 58.1	54.0	183 28.4	06.9		225 10.8	07.3		165 11.1	31.8					Antares	112 59.5	S26 22.9
17	333 19.2	87 57.3	54.6	198 30.7	07.0		240 13.6	07.3		180 13.6	31.8							
18	348 21.7	102 56.4	S20 55.2	213 33.1	N20 07.0		255 16.4	N23 07.4		195 16.1	N12 31.8					Arcturus	146 20.5	N19 17.8
19	3 24.1	117 55.6	55.8	228 35.4	07.1		270 19.3	07.4		210 18.5	31.8					Atria	108 26.0	S68 59.2
20	18 26.6	132 54.8	56.4	243 37.7	07.2		285 22.1	07.4		225 21.0	31.8					Avior	234 28.4	S59 26.2
21	33 29.1	147 53.9	57.0	258 40.1	07.3		300 24.9	07.4		240 23.4	31.8					Bellatrix	279 00.4	N 6 19.7
22	48 31.5	162 53.1	57.6	273 42.4	07.4		315 27.7	07.4		255 25.9	31.8					Betelgeuse	271 30.0	N 7 24.1
23	63 34.0	177 52.2	58.3	288 44.7	07.4		330 30.5	07.4		270 28.3	31.8							
10 00	78 36.5	192 51.4	S20 58.9	303 47.1	N20 07.5		345 33.3	N23 07.4		285 30.8	N12 31.9					Canopus	264 07.5	S52 41.1
01	93 38.9	207 50.6	20 59.5	318 49.4	07.6		0 36.1	07.4		300 33.2	31.9					Capella	281 13.6	N45 58.5
02	108 41.4	222 49.7	21 00.1	333 51.7	07.7		15 38.9	07.4		315 35.7	31.9					Deneb	49 50.0	N45 12.4
03	123 43.9	237 48.9	00.7	348 54.1	07.8		30 41.7	07.5		330 38.1	31.9					Denebola	183 01.0	N14 41.6
04	138 46.3	252 48.0	01.3	3 56.4	07.8		45 44.5	07.5		345 40.6	31.9					Diphda	349 22.6	S18 06.5
05	153 48.8	267 47.2	01.9	18 58.8	07.9		60 47.4	07.5		0 43.0	31.9							
06	168 51.2	282 46.3	S21 02.5	34 01.1	N20 08.0		75 50.2	N23 07.5		15 45.5	N12 31.9					Dubhe	194 24.5	N61 51.9
07	183 53.7	297 45.5	03.1	49 03.5	08.1		90 53.0	07.5		30 48.0	31.9					Elnath	278 46.1	N28 35.3
S 08	198 56.2	312 44.6	03.7	64 05.8	08.2		105 55.8	07.5		45 50.4	31.9					Eltanin	90 59.1	N51 29.7
A 09	213 58.6	327 43.8	04.3	79 08.2	08.3		120 58.6	07.5		60 52.9	31.9					Enif	34 13.6	N 9 46.6
T 10	229 01.1	342 43.0	04.9	94 10.5	08.3		136 01.4	07.5		75 55.3	31.9					Fomalhaut	15 53.6	S29 44.5
11	244 03.6	357 42.1	05.5	109 12.9	08.4		151 04.2	07.6		90 57.8	31.9							
R 12	259 06.0	12 41.3	S21 06.1	124 15.2	N20 08.5		166 07.0	N23 07.6		106 00.2	N12 31.9					Gacrux	172 30.9	S56 59.1
D 13	274 08.5	27 40.4	06.7	139 17.6	08.6		181 09.8	07.6		121 02.7	31.9					Gienah	176 20.0	S17 25.1
A 14	289 11.0	42 39.6	07.3	154 19.9	08.7		196 12.7	07.6		136 05.1	32.0					Hadar	149 26.3	S60 15.7
15	304 13.4	57 38.7	07.9	169 22.3	08.8		211 15.5	07.6		151 07.6	32.0					Hamal	328 30.8	N23 21.6
Y 16	319 15.9	72 37.9	08.5	184 24.6	08.8		226 18.3	07.6		166 10.1	32.0					Kaus Aust.	84 19.7	S34 23.7
17	334 18.3	87 37.0	09.0	199 27.0	08.9		241 21.1	07.6		181 12.5	32.0							
18	349 20.8	102 36.2	S21 09.6	214 29.4	N20 09.0		256 23.9	N23 07.6		196 15.0	N12 32.0					Kochab	137 20.1	N74 14.6
19	4 23.3	117 35.3	10.2	229 31.7	09.1		271 26.7	07.6		211 17.4	32.0					Markab	14 05.0	N15 05.4
20	19 25.7	132 34.5	10.8	244 34.1	09.2		286 29.5	07.7		226 19.9	32.0					Menkar	314 42.8	N 4 00.2
21	34 28.2	147 33.6	11.4	259 36.4	09.3		301 32.4	07.7		241 22.3	32.0					Menkent	148 39.5	S36 15.5
22	49 30.7	162 32.8	12.0	274 38.8	09.4		316 35.2	07.7		256 24.8	32.0					Miaplacidus	221 44.7	S69 37.4
23	64 33.1	177 31.9	12.6	289 41.2	09.5		331 38.0	07.7		271 27.3	32.0							
11 00	79 35.6	192 31.1	S21 13.2	304 43.5	N20 09.5		346 40.8	N23 07.7		286 29.7	N12 32.0					Mirfak	309 18.3	N49 37.1
01	94 38.1	207 30.2	13.7	319 45.9	09.6		1 43.6	07.7		301 32.2	32.0					Nunki	76 31.9	S26 19.4
02	109 40.5	222 29.4	14.3	334 48.3	09.7		16 46.4	07.7		316 34.6	32.0					Peacock	54 01.8	S56 48.5
03	124 43.0	237 28.5	14.9	349 50.7	09.8		31 49.2	07.7		331 37.1	32.1					Pollux	244 00.2	N28 04.6
04	139 45.5	252 27.7	15.5	4 53.0	09.9		46 52.1	07.8		346 39.6	32.1					Procyon	245 27.5	N 5 16.8
05	154 47.9	267 26.8	16.0	19 55.4	10.0		61 54.9	07.8		1 42.0	32.1							
06	169 50.4	282 25.9	S21 16.6	34 57.8	N20 10.1		76 57.7	N23 07.8		16 44.5	N12 32.1					Rasalhague	96 31.7	N12 34.7
07	184 52.8	297 25.1	17.2	50 00.2	10.2		92 00.5	07.8		31 46.9	32.1					Regulus	208 11.9	N12 04.4
08	199 55.3	312 24.2	17.8	65 02.6	10.3		107 03.3	07.8		46 49.4	32.1					Rigel	281 37.5	S 8 13.7
S 09	214 57.8	327 23.4	18.3	80 04.9	10.4		122 06.1	07.8		61 51.9	32.1					Rigel Kent.	140 28.8	S60 44.3
U 10	230 00.2	342 22.5	18.9	95 07.3	10.5		137 08.9	07.8		76 54.3	32.1					Sabik	102 43.6	S15 41.7
N 11	245 02.7	357 21.7	19.5	110 09.7	10.6		152 11.8	07.8		91 56.8	32.1							
D 12	260 05.2	12 20.8	S21 20.1	125 12.1	N20 10.6		167 14.6	N23 07.8		106 59.2	N12 32.1					Schedar	350 10.8	N56 25.3
A 13	275 07.6	27 19.9	20.6	140 14.5	10.7		182 17.4	07.9		122 01.7	32.1					Shoula	96 58.7	S37 05.2
14	290 10.1	42 19.1	21.2	155 16.9	10.8		197 20.2	07.9		137 04.2	32.1					Sirius	258 57.0	S16 41.2
15	305 12.6	57 18.2	21.8	170 19.3	10.9		212 23.0	07.9		152 06.6	32.2					Spica	158 59.7	S11 02.7
16	320 15.0</																	



DECEMBER 9, 10, 11 (FRI., SAT., SUN.)

G.M.T.	SUN				MOON				Lat.	Twilight		Sunrise	Moonrise			
	G.H.A.	Dec.	G.H.A.	Dec.	d	H.P.	Naut.	Civil		9	10		11	12		
9 00	181 57.7	S22 47.1	206 56.2	5.3	S15 14.6	6.9	60.8	N 72	08 12	10 29	h m	h m	h m	h m		
01	196 57.4	47.3	221 20.5	5.2	15 21.5	6.8	60.8	N 70	07 53	09 37	h m	h m	h m	h m		
02	211 57.1	47.6	235 44.7	5.1	15 28.3	6.7	60.9	68	07 38	09 05	h m	h m	h m	h m		
03	226 56.8	47.8	250 08.8	5.1	15 35.0	6.5	60.9	66	07 26	08 41	10 15	07 13	08 43	09 54	10 42	
04	241 56.6	48.1	264 32.9	5.0	15 41.5	6.5	60.9	64	07 15	08 22	09 37	06 55	08 21	09 31	10 22	
05	256 56.3	48.3	278 56.9	4.9	15 48.0	6.4	60.9	62	07 06	08 07	09 11	06 40	08 03	09 13	10 05	
06	271 56.0	S22 48.6	293 20.8	4.9	S15 54.4	6.3	61.0	60	06 58	07 54	08 51	06 28	07 49	08 57	09 51	
07	286 55.7	48.8	307 44.7	4.8	16 00.7	6.1	61.0	N 58	06 51	07 43	08 34	06 18	07 36	08 45	09 40	
08	301 55.4	49.0	322 08.5	4.7	16 06.8	6.0	61.0	56	06 44	07 33	08 20	06 08	07 25	08 33	09 29	
09	316 55.2	49.3	336 32.2	4.6	16 12.8	6.0	61.0	54	06 38	07 24	08 08	06 00	07 16	08 24	09 20	
F R I	331 54.9	49.5	350 55.8	4.6	16 18.8	5.8	61.1	52	06 33	07 16	07 57	05 53	07 08	08 15	09 12	
10	346 54.6	49.8	5 19.4	4.5	16 24.6	5.7	61.1	50	06 28	07 09	07 47	05 47	07 00	08 07	09 05	
D A Y	1 54.3	S22 50.0	19 42.9	4.5	S16 30.3	5.6	61.1	45	06 16	06 53	07 27	05 33	06 44	07 50	08 49	
13	16 54.0	50.3	34 06.4	4.3	16 35.9	5.4	61.1	N 40	06 06	06 40	07 11	05 21	06 31	07 37	08 36	
14	31 53.8	50.5	48 29.7	4.4	16 41.3	5.4	61.1	35	05 57	06 29	06 57	05 11	06 20	07 25	08 25	
15	46 53.5	50.7	62 53.1	4.2	16 46.7	5.2	61.2	30	05 49	06 19	06 45	05 03	06 10	07 15	08 15	
16	61 53.2	51.0	77 16.3	4.2	16 51.9	5.1	61.2	20	05 33	05 00	06 24	04 48	05 53	06 57	07 59	
17	76 52.9	51.2	91 39.5	4.1	16 57.0	5.0	61.2	N 10	05 17	05 43	06 06	04 35	05 38	06 42	07 44	
18	91 52.6	S22 51.4	106 02.6	4.1	S17 02.0	4.9	61.2	0	05 01	05 27	05 49	04 23	05 25	06 28	07 31	
19	106 52.4	51.7	120 25.7	4.0	17 06.9	4.7	61.2	S 10	04 42	05 09	05 32	04 12	05 11	06 14	07 17	
20	121 52.1	51.9	134 48.7	4.0	17 11.6	4.6	61.2	20	04 20	04 49	05 13	03 59	04 57	05 59	07 03	
21	136 51.8	52.2	149 11.7	3.9	17 16.2	4.5	61.3	30	03 51	04 25	04 52	03 45	04 40	05 41	06 46	
22	151 51.5	52.4	163 34.6	3.9	17 20.7	4.4	61.3	35	03 33	04 10	04 39	03 37	04 31	05 31	06 37	
23	166 51.2	52.6	177 57.5	3.8	17 25.1	4.2	61.3	40	03 11	03 52	04 25	03 27	04 20	05 20	06 26	
10 00	181 50.9	S22 52.9	192 20.3	3.7	S17 29.3	4.1	61.3	45	02 41	03 30	04 07	03 16	04 07	05 06	06 13	
01	196 50.7	53.1	206 43.0	3.7	17 33.4	4.0	61.3	S 50	01 58	03 01	03 45	03 03	03 52	04 50	05 57	
02	211 50.4	53.3	221 05.7	3.7	17 37.4	3.9	61.3	52	01 32	02 47	03 35	02 57	03 45	04 42	05 49	
03	226 50.1	53.5	235 28.4	3.6	17 41.3	3.7	61.3	54	00 54	02 30	03 23	02 50	03 37	04 34	05 41	
04	241 49.8	53.8	249 51.0	3.6	17 45.0	3.5	61.4	56		02 09	03 09	02 43	03 28	04 24	05 32	
05	256 49.5	54.0	264 13.6	3.5	17 48.5	3.5	61.4	58		01 41	02 53	02 34	03 18	04 13	05 22	
06	271 49.2	S22 54.2	278 36.1	3.5	S17 52.0	3.3	61.4	S 60		00 59	02 34	02 25	03 06	04 01	05 10	
07	286 49.0	54.5	292 58.6	3.5	17 55.3	3.2	61.4		Lat.	Sunset	Twilight	Moonset				
08	301 48.7	54.7	307 21.1	3.4	17 58.5	3.0	61.4		Civil	Naut.	9	10	11	12		
09	316 48.4	54.9	321 43.5	3.4	18 01.5	2.9	61.4		h m	h m	h m	h m	h m	h m	h m	
10	331 48.1	55.1	336 05.9	3.4	18 04.4	2.8	61.4	N 72	h m	h m	h m	h m	h m	h m	h m	
11	346 47.8	55.3	350 28.3	3.3	18 07.2	2.6	61.4	N 70	h m	h m	h m	h m	h m	h m	h m	
12	1 47.5	S22 55.6	4 50.6	3.3	S18 09.8	2.5	61.4	68	h m	h m	h m	h m	h m	h m	h m	
13	16 47.3	55.8	19 12.9	3.3	18 12.3	2.4	61.4	66	13 30	15 04	16 20	13 54	14 33	15 33	16 55	
14	31 47.0	56.0	33 35.2	3.2	18 14.7	2.2	61.4	64	14 08	15 23	16 30	14 12	14 55	15 56	17 15	
15	46 46.7	56.2	47 57.4	3.2	18 16.9	2.1	61.5	62	14 34	15 38	16 39	14 28	15 13	16 15	17 31	
16	61 46.4	56.5	62 19.6	3.2	18 19.0	1.9	61.5	60	14 55	15 51	16 47	14 40	15 28	16 30	17 45	
17	76 46.1	56.7	76 41.8	3.2	18 20.9	1.8	61.5	N 58	15 11	16 03	16 55	14 51	15 40	16 43	17 56	
18	91 45.8	S22 56.9	91 04.0	3.2	S18 22.7	1.7	61.5	56	15 26	16 12	17 01	15 01	15 51	16 54	18 06	
19	106 45.5	57.1	105 26.2	3.1	18 24.4	1.5	61.5	54	15 38	16 21	17 07	15 09	16 01	17 03	18 15	
20	121 45.3	57.3	119 48.3	3.1	18 25.9	1.4	61.5	52	15 49	16 29	17 13	15 17	16 09	17 12	18 23	
21	136 45.0	57.5	134 10.4	3.2	18 27.3	1.2	61.5	50	15 58	16 36	17 18	15 24	16 17	17 20	18 30	
22	151 44.7	57.8	148 32.6	3.1	18 28.5	1.1	61.5	45	16 18	16 52	17 29	15 39	16 34	17 36	18 45	
23	166 44.4	58.0	162 54.7	3.1	18 29.6	1.0	61.5	N 40	16 35	17 05	17 39	15 51	16 47	17 50	18 58	
11 00	181 44.1	S22 58.2	177 16.8	3.1	S18 30.6	0.8	61.5	35	16 49	17 17	17 48	16 01	16 58	18 02	19 08	
01	196 43.8	58.4	191 38.9	3.1	18 31.4	0.6	61.5	30	17 01	17 27	17 57	16 10	17 09	18 12	19 17	
02	211 43.5	58.6	206 01.0	3.1	18 32.0	0.6	61.5	20	17 21	17 45	18 13	16 26	17 26	18 29	19 33	
03	226 43.2	58.8	220 23.1	3.1	18 32.6	0.4	61.5	N 10	17 39	18 02	18 29	16 39	17 41	18 44	19 47	
04	241 43.0	59.0	234 45.2	3.1	18 33.0	0.2	61.5	0	17 57	18 19	18 45	16 52	17 55	18 58	20 00	
05	256 42.7	59.2	249 07.3	3.1	18 33.2	0.1	61.5	S 10	18 14	18 37	19 04	17 05	18 09	19 12	20 13	
06	271 42.4	S22 59.4	263 29.4	3.1	S18 33.3	0.1	61.5	20	18 32	18 57	19 26	17 19	18 24	19 27	20 26	
07	286 42.1	59.6	277 51.5	3.1	18 33.2	0.1	61.5	30	18 54	19 21	19 54	17 35	18 41	19 44	20 42	
08	301 41.8	59.9	292 13.6	3.1	18 33.1	0.4	61.4	35	19 07	19 36	20 13	17 44	18 51	19 54	20 51	
S A T	316 41.5	60.1	306 35.7	3.1	18 32.7	0.5	61.4	40	19 21	19 54	20 35	17 54	19 02	20 05	21 01	
10	331 41.2	60.3	320 57.8	3.2	18 32.2	0.6	61.4	45	19 39	20 16	21 05	18 06	19 16	20 18	21 13	
11	346 40.9	60.5	335 20.0	3.1	18 31.6	0.7	61.4	S 50	20 01	20 45	21 49	18 21	19 32	20 34	21 27	
D A Y	1 40.6	S23 00.7	349 42.1	3.2	S18 30.9	0.9	61.4	52	20 11	20 59	22 15	18 28	19 40	20 42	21 34	
13	16 40.4	00.9	4 04.3	3.2	18 30.0	1.1	61.4	54	20 23	21 17	22 54	18 56	19 48	20 50	21 41	
14	31 40.1	01.1	18 26.5	3.2	18 28.9	1.4	61.4	56	20 37	21 38		18 45	19 58	21 00	21 50	
15	46 39.8	01.3	32 48.7	3.3	18 27.8	1.4	61.4	58	20 53	22 06		18 55	20 08	21 10	21 59	
16	61 39.5	01.5	47 11.0	3.3	18 26.4	1.4	61.4	S 60	21 13	22 49		19 06	20 21	21 23	22 10	
17	76 39.2	01.7	61 33.3	3.3	18 25.0	1.6	61.4									
18	91 38.9	S23 01.9	75 55.6	3.3	S18 23.4	1.8	61.4									
19	106 38.6	02.1	90 17.9	3.3	18 21.6	1.8	61.4									
20	121 38.3	02.3	104 40.2	3.4	18 19.8	2.1	61.3									
21	136 38.0	02.5	119 02.6	3.5	18 17.7	2.1	61.3									
22	151 37.7	02.7	133 25.1	3.4												

DECEMBER 12, 13, 14 (MON., TUES., WED.)

G.M.T.	ARIES			VENUS -3.4			MARS -0.4			JUPITER -2.3			SATURN +0.7			STARS							
	G.H.A.	G.M.A.	Dec.	G.H.A.	G.M.A.	Dec.	G.H.A.	G.M.A.	Dec.	G.H.A.	G.M.A.	Dec.	G.H.A.	G.M.A.	Dec.	Name	S.H.A.	Dec.					
12 00 01 02 03 04 05 06 07 08 09 10 11 12 13 14 15 16 17 18 19 20 21 22 23	80	34.7	192	10.5	S21	26.8	305	40.8	N20	11.8	347	48.4	N23	08.0	287	28.8	N12	32.2	Acamar	315	38.3	S40	23.8
	95	37.2	207	09.6	27.4	320	43.2	11.9	2	51.2	08.0	302	31.2	32.3	302	31.2	32.3	Achernar	335	46.4	S57	21.2	
	110	39.7	222	08.8	27.9	335	45.6	12.0	17	54.0	08.0	317	33.7	32.3	317	33.7	32.3	Acruz	173	39.3	S62	58.3	
	125	42.1	237	07.9	28.5	350	48.0	12.1	32	56.8	08.0	332	36.2	32.3	332	36.2	32.3	Adhara	255	33.2	S28	56.6	
	140	44.6	252	07.0	29.0	5	50.5	12.2	47	59.6	08.0	347	38.6	32.3	347	38.6	32.3	Aldebaran	291	19.8	N16	27.9	
	155	47.1	267	06.2	29.6	20	52.9	12.3	63	02.5	08.0	2	41.1	32.3	2	41.1	32.3						
	170	49.5	282	05.3	S21	30.1	35	55.3	N20	12.4	78	05.3	N23	08.1	17	43.6	N12	32.3	Alioth	166	44.5	N56	04.5
	185	52.0	297	04.4	30.7	50	57.7	12.5	93	08.1	08.1	32	46.0	32.3	32	46.0	32.3	Alkaid	153	20.3	N49	25.2	
	200	54.4	312	03.6	31.2	66	00.1	12.6	108	10.9	08.1	47	48.5	32.3	47	48.5	32.3	Al Na'ir	28	17.5	S47	04.2	
	215	56.9	327	02.7	31.8	81	02.5	12.7	123	13.7	08.1	62	51.0	32.3	62	51.0	32.3	Alnilam	276	13.2	S 1	13.0	
	230	59.4	342	01.8	32.3	96	04.9	12.8	138	16.5	08.1	77	53.4	32.3	77	53.4	32.3	Alphard	218	22.2	S 8	33.8	
	246	01.8	357	01.0	32.9	111	07.4	12.9	153	19.4	08.1	92	55.9	32.4	92	55.9	32.4						
	261	04.3	12	00.1	S21	33.4	126	09.8	N20	13.0	168	22.2	N23	08.1	107	58.3	N12	32.4	Alphecca	126	34.1	N26	47.4
	276	06.8	26	59.2	34.0	141	12.2	13.1	183	25.0	08.1	123	00.8	32.4	123	00.8	32.4	Alpheratz	358	11.1	N28	58.3	
	291	09.2	41	58.4	34.5	156	14.6	13.2	198	27.8	08.2	138	03.3	32.4	138	03.3	32.4	Alhair	62	34.6	N 8	48.8	
	306	11.7	56	57.5	35.0	171	17.0	13.3	213	30.6	08.2	153	05.7	32.4	153	05.7	32.4	Ankaa	353	42.0	S42	25.7	
	321	14.2	71	56.6	35.6	186	19.5	13.4	228	33.5	08.2	168	08.2	32.4	168	08.2	32.4	Antares	112	59.5	S26	22.9	
	336	16.6	86	55.7	36.1	201	21.9	13.5	243	36.3	08.2	183	10.7	32.4	183	10.7	32.4						
	351	19.1	101	54.9	S21	36.7	216	24.3	N20	13.7	258	39.1	N23	08.2	198	13.1	N12	32.4	Arcturus	146	20.4	N19	17.8
	6	21.6	116	54.0	37.2	231	26.7	13.8	273	41.9	08.2	213	15.6	32.4	213	15.6	32.4	Atria	108	25.9	S68	59.1	
	21	24.0	131	53.1	37.7	246	29.2	13.9	288	44.7	08.2	228	18.1	32.4	228	18.1	32.4	Avior	234	28.4	S59	26.2	
	36	26.5	146	52.3	38.3	261	31.6	14.0	303	47.6	08.2	243	20.5	32.5	243	20.5	32.5	Bellatrix	279	00.4	N 6	19.7	
	51	28.9	161	51.4	38.8	276	34.0	14.1	318	50.4	08.2	258	23.0	32.5	258	23.0	32.5	Betelgeuse	271	30.0	N 7	24.1	
66	31.4	176	50.5	39.3	291	36.5	14.2	333	53.2	08.3	273	25.5	32.5	273	25.5	32.5							
13 00 01 02 03 04 05 06 07 08 09 10 11 12 13 14 15 16 17 18 19 20 21 22 23	81	33.9	191	49.6	S21	39.9	306	38.9	N20	14.3	348	56.0	N23	08.3	288	27.9	N12	32.5	Canopus	264	07.5	S52	41.1
	96	36.3	206	48.8	40.4	321	41.4	14.4	3	58.8	08.3	303	30.4	32.5	303	30.4	32.5	Capella	281	13.5	N45	58.5	
	111	38.8	221	47.9	40.9	336	43.8	14.5	19	01.7	08.3	318	32.9	32.5	318	32.9	32.5	Deneb	49	50.0	N45	12.4	
	126	41.3	236	47.0	41.4	351	46.2	14.6	34	04.5	08.3	333	35.3	32.5	333	35.3	32.5	Denebola	183	01.0	N14	41.6	
	141	43.7	251	46.1	42.0	6	48.7	14.7	49	07.3	08.3	348	37.8	32.5	348	37.8	32.5	Diphda	349	22.7	S18	06.5	
	156	46.2	266	45.3	42.5	21	51.1	14.8	64	10.1	08.3	3	40.3	32.6	3	40.3	32.6						
	171	48.7	281	44.4	S21	43.0	36	53.6	N20	15.0	79	12.9	N23	08.3	18	42.7	N12	32.6	Dubhe	194	24.5	N61	51.9
	186	51.1	296	43.5	43.5	51	56.0	15.1	94	15.8	08.3	33	45.2	32.6	33	45.2	32.6	Elnath	278	46.1	N28	35.3	
	201	53.6	311	42.6	44.1	66	58.5	15.2	109	18.6	08.4	48	47.7	32.6	48	47.7	32.6	Ethanin	90	59.1	N51	29.7	
	216	56.1	326	41.8	44.6	82	00.9	15.3	124	21.4	08.4	63	50.2	32.6	63	50.2	32.6	Enif	34	13.6	N 9	46.6	
	231	58.5	341	40.9	45.1	97	03.4	15.4	139	24.2	08.4	78	52.6	32.6	78	52.6	32.6	Fomalhaut	15	53.6	S29	44.5	
	247	01.0	356	40.0	45.6	112	05.8	15.5	154	27.0	08.4	93	55.1	32.6	93	55.1	32.6						
	262	03.4	11	39.1	S21	46.1	127	08.3	N20	15.6	169	29.9	N23	08.4	108	57.6	N12	32.6	Gacrux	172	30.9	S56	59.1
	277	05.9	26	38.3	46.7	142	10.7	15.7	184	32.7	08.4	124	00.0	32.6	124	00.0	32.6	Gienah	176	19.9	S17	25.1	
	292	08.4	41	37.4	47.2	157	13.2	15.9	199	35.5	08.4	139	02.5	32.7	139	02.5	32.7	Hadar	149	26.3	S60	15.7	
	307	10.8	56	36.5	47.7	172	15.6	16.0	214	38.3	08.4	154	05.0	32.7	154	05.0	32.7	Hamal	328	30.8	N23	21.6	
	322	13.3	71	35.6	48.2	187	18.1	16.1	229	41.1	08.4	169	07.4	32.7	169	07.4	32.7	Kaus Aust.	84	19.7	S34	23.7	
	337	15.8	86	34.7	48.7	202	20.6	16.2	244	44.0	08.5	184	09.9	32.7	184	09.9	32.7						
	352	18.2	101	33.9	S21	49.2	217	23.0	N20	16.3	259	46.8	N23	08.5	199	12.4	N12	32.7	Kochab	137	20.1	N74	14.6
	7	20.7	116	33.0	49.7	232	25.5	16.4	274	49.6	08.5	214	14.9	32.7	214	14.9	32.7	Markab	14	05.0	N15	05.4	
	22	23.2	131	32.1	50.2	247	27.9	16.5	289	52.4	08.5	229	17.3	32.7	229	17.3	32.7	Menkar	314	42.8	N 4	00.2	
	37	25.6	146	31.2	50.7	262	30.4	16.7	304	55.3	08.5	244	19.8	32.7	244	19.8	32.7	Menkent	148	39.4	S36	15.5	
	52	28.1	161	30.3	51.3	277	32.9	16.8	319	58.1	08.5	259	22.3	32.8	259	22.3	32.8	Miaplacidus	221	44.6	S69	37.4	
67	30.5	176	29.5	51.8	292	35.3	16.9	335	00.9	08.5	274	24.7	32.8	274	24.7	32.8							
14 00 01 02 03 04 05 06 07 08 09 10 11 12 13 14 15 16 17 18 19 20 21 22 23	82	33.0	191	28.6	S21	52.3	307	37.8	N20	17.0	350	03.7	N23	08.5	289	27.2	N12	32.8	Mirfak	309	18.3	N49	47.1
	97	35.5	206	27.7	52.8	322	40.3	17.1	5	06.5	08.5	304	29.7	32.8	304	29.7	32.8	Nunki	76	31.8	S26	19.4	
	112	37.9	221	26.8	53.3	337	42.8	17.3	20	09.4	08.6	319	32.2	32.8	319	32.2	32.8	Peacock	54	01.8	S56	48.5	
	127	40.4	236	25.9	53.8	352	45.2	17.4	35	12.2	08.6	334	34.6	32.8	334	34.6	32.8	Pollux	244	00.1	N28	04.6	
	142	42.9	251	25.0	54.3	7	47.7	17.5	50	15.0	08.6	349	37.1	32.8	349	37.1	32.8	Procyon	245	27.4	N 5	16.8	
	157	45.3	266	24.1	54.8	22	50.2	17.6	65	17.8	08.6	4	39.6	32.9	4	39.6	32.9						
	172	47.8	281	23.3	S21	55.3	37	52.7	N20	17.7	80	20.7	N23	08.6	19	42.0	N12	32.9	Rasalhague	96	31.7	N12	34.7
	187	50.3	296	22.4	55.8	52	55.2	17.9	95	23.5	08.6	34	44.5	32.9	34	44.5	32.9	Regulus	208	11.9	N12	04.4	
	202	52.7	311	21.5	56.3	67	57.6	18.0	110	26.3	08.6	49	47.0	32.9	49	47.0	32.9	Rigel	281	37.5	S 8	13.7	
	217	55.2	326	20.6	56.8	83	00.1	18.1	125	29.1	08.6	64	49.5	32.9	64	49.5	32.9	Rigil Kent.	140	28.8	S60	44.3	
	232	57.7	341	19.7	57.2	98	02.6	18.2	140	32.0	08.6	79	51.9	32.9	79	51.9	32.9	Sabik	102	43.6	S15	41.7	
	248	00.1	356	18.8	57.7	113	05.1	18.3	155	34.8													

DECEMBER 12, 13, 14 (MON., TUES., WED.)

G.M.T.	SUN				MOON				Lat.	Twilight		Sunrise	Moonrise						
	G.H.A.	Dec.	G.H.A.	Dec.	G.H.A.	Dec.	d	H.P.		Naut.	Civil		12	13	14	15			
12 00	181	37.2	S23	03.1	162	10.0	3.6	S18	10.9	2.6	61.3	N 72	08 17	10 40	12 55	12 33	12 23	12 16	
01	196	36.9		03.2	176	32.6	3.5	18	08.3	2.7	61.3	N 70	07 58	09 44	11 46	11 57	12 02	12 03	
02	211	36.6		03.4	190	55.1	3.7	18	05.6	2.8	61.3	68	07 42	09 10	11 09	11 32	11 45	11 53	
03	226	36.3		03.6	205	17.8	3.6	18	02.8	3.0	61.2	66	07 30	08 46	10 23	10 42	11 12	11 31	11 44
04	241	36.0		03.8	219	40.4	3.7	17	59.8	3.1	61.2	64	07 19	08 27	09 43	10 22	10 56	11 20	11 37
05	256	35.7		04.0	234	03.1	3.8	17	56.7	3.2	61.2	62	07 09	08 11	09 16	10 05	10 43	11 10	11 31
06	271	35.4	S23	04.2	248	25.9	3.8	S17	53.5	3.4	61.2	60	07 01	07 58	08 55	09 51	10 32	11 02	11 25
07	286	35.1		04.4	262	48.7	3.9	17	50.1	3.5	61.2	N 58	06 54	07 46	08 38	09 40	10 22	10 55	11 20
08	301	34.8		04.6	277	11.6	3.9	17	46.6	3.6	61.2	56	06 47	07 36	08 23	09 29	10 13	10 48	11 16
09	316	34.5		04.8	291	34.5	4.0	17	43.0	3.8	61.1	54	06 41	07 27	08 11	09 20	10 06	10 42	11 12
10	331	34.2		05.0	305	57.5	4.0	17	39.2	3.9	61.1	52	06 36	07 19	08 00	09 12	09 59	10 37	11 09
11	346	34.0		05.1	320	20.5	4.1	17	35.3	4.0	61.1	50	06 30	07 12	07 50	09 05	09 53	10 32	11 05
12	1	33.7	S23	05.3	334	43.6	4.1	S17	31.3	4.1	61.1	45	06 19	06 56	07 30	08 49	09 39	10 22	10 58
13	16	33.4		05.5	349	06.7	4.2	17	27.2	4.3	61.1	N 40	06 09	06 43	07 13	08 36	09 28	10 13	10 53
14	31	33.1		05.7	3	29.9	4.3	17	22.9	4.4	61.0	35	05 59	06 31	06 59	08 25	09 19	10 06	10 48
15	46	32.8		05.9	17	53.2	4.3	17	18.5	4.5	61.0	30	05 51	06 21	06 47	08 15	09 10	09 59	10 43
16	61	32.5		06.1	32	16.5	4.4	17	14.0	4.6	61.0	20	05 35	06 02	06 26	07 59	08 56	09 48	10 35
17	76	32.2		06.2	46	39.9	4.5	17	09.4	4.7	61.0	N 10	05 19	05 45	06 08	07 44	08 43	09 38	10 28
18	91	31.9	S23	06.4	61	03.4	4.5	S17	04.7	4.9	60.9	0	05 02	05 28	05 50	07 31	08 31	09 28	10 22
19	106	31.6		06.6	75	26.9	4.6	16	59.8	5.0	60.9	S 10	04 43	05 10	05 33	07 17	08 19	09 19	10 16
20	121	31.3		06.8	89	50.5	4.6	16	54.8	5.1	60.9	20	04 21	04 50	05 14	07 03	08 07	09 09	10 09
21	136	31.0		06.9	104	14.1	4.7	16	49.7	5.2	60.9	30	03 52	04 25	04 53	06 46	07 52	08 58	10 01
22	151	30.7		07.1	118	37.8	4.8	16	44.5	5.3	60.8	35	03 34	04 10	04 40	06 37	07 44	08 51	09 56
23	166	30.4		07.3	133	01.6	4.9	16	39.2	5.5	60.8	40	03 11	03 52	04 25	06 26	07 34	08 44	09 51
13 00	181	30.1	S23	07.5	147	25.5	4.9	S16	33.7	5.6	60.8	45	02 41	03 30	04 07	06 13	07 23	08 35	09 45
01	196	29.8		07.6	161	49.4	5.1	16	28.1	5.6	60.8	S 50	01 56	03 01	03 45	05 57	07 09	08 24	09 38
02	211	29.5		07.8	176	13.5	5.1	16	22.5	5.8	60.7	52	01 30	02 46	03 34	05 49	07 03	08 19	09 35
03	226	29.3		08.0	190	37.6	5.1	16	16.7	5.9	60.7	54	00 48	02 28	03 22	05 41	06 56	08 14	09 31
04	241	29.0		08.2	205	01.7	5.3	16	10.8	6.0	60.7	56	00 00	02 07	03 08	05 32	06 48	08 08	09 27
05	256	28.7		08.3	219	26.0	5.3	16	04.8	6.1	60.7	58	00 00	01 38	02 52	05 22	06 39	08 01	09 22
06	271	28.4	S23	08.5	233	50.3	5.4	S15	58.7	6.2	60.6	S 60	00 00	00 53	02 32	05 10	06 29	07 53	09 17
07	286	28.1		08.7	248	14.7	5.4	15	52.5	6.3	60.6								
08	301	27.8		08.8	262	39.1	5.6	15	46.2	6.5	60.6								
09	316	27.5		09.0	277	03.7	5.6	15	39.7	6.5	60.5								
10	331	27.2		09.2	291	28.3	5.7	15	33.2	6.6	60.5								
11	346	26.9		09.3	305	53.0	5.8	15	26.6	6.7	60.5								
12	1	26.6	S23	09.5	320	17.8	5.9	S15	19.9	6.8	60.4								
13	16	26.3		09.7	334	42.7	6.0	15	13.1	6.9	60.4								
14	31	26.0		09.8	349	07.7	6.0	15	06.2	7.0	60.4								
15	46	25.7		10.0	3	32.7	6.1	14	59.2	7.1	60.4								
16	61	25.4		10.2	17	57.8	6.3	14	52.1	7.2	60.3								
17	76	25.1		10.3	32	23.1	6.3	14	44.9	7.3	60.3								
18	91	24.8	S23	10.5	46	48.4	6.3	S14	37.6	7.4	60.3								
19	106	24.5		10.6	61	13.7	6.5	14	30.2	7.4	60.2								
20	121	24.2		10.8	75	39.2	6.5	14	22.8	7.6	60.2								
21	136	23.9		11.0	90	04.7	6.7	14	15.2	7.6	60.2								
22	151	23.6		11.1	104	30.4	6.7	14	07.6	7.7	60.1								
23	166	23.3		11.3	118	56.1	6.8	13	59.9	7.8	60.1								
14 00	181	23.0	S23	11.4	133	21.9	6.9	S13	52.1	7.9	60.1								
01	196	22.7		11.6	147	47.8	7.0	13	44.2	8.0	60.0								
02	211	22.4		11.7	162	13.8	7.0	13	36.2	8.0	60.0								
03	226	22.1		11.9	176	39.8	7.2	13	28.2	8.1	59.9								
04	241	21.8		12.0	191	06.0	7.2	13	20.1	8.2	59.9								
05	256	21.5		12.2	205	32.2	7.4	13	11.9	8.2	59.9								
06	271	21.2	S23	12.4	219	58.6	7.4	S13	03.7	8.4	59.8								
07	286	20.9		12.5	234	25.0	7.5	12	55.3	8.4	59.8								
08	301	20.6		12.7	248	51.5	7.5	12	46.9	8.5	59.8								
09	316	20.3		12.8	263	18.0	7.7	12	38.4	8.5	59.7								
10	331	20.0		12.9	277	44.7	7.8	12	29.9	8.6	59.7								
11	346	19.7		13.1	292	11.5	7.8	12	21.3	8.7	59.7								
12	1	19.4	S23	13.2	306	38.3	7.9	S12	12.6	8.7	59.6								
13	16	19.1		13.4	321	05.2	8.1	12	03.9	8.8	59.6								
14	31	18.8		13.5	335	32.3	8.1	11	55.1	8.9	59.5								
15	46	18.5		13.7	349	59.4	8.1	11	46.2	8.9	59.5								
16	61	18.2		13.8	4	26.5	8.3	11	37.3	9.0	59.5								
17	76	17.9		14.0	18	53.8	8.4	11	28.3	9.0	59.4								
18	91	17.6	S23	14.1	33	21.2	8.4	S11	19.3	9.1	59.4								
19	106	17.3		14.2	47	48.6	8.5	11	10.2	9.2	59.4								
20	121	17.0		14.4	62	16.1	8.6	11	01.0	9.2	59.3								
21	136	16.7		14.5	76	43.7	8.7	10	51.8										

DECEMBER 18, 19, 20 (SUN., MON., TUES.)

G.M.T.	ARIES			VENUS -3.4			MARS -0.5			JUPITER -2.3			SATURN +0.7			STARS		
	G.M.A.	G.M.A.	Dec	G.M.A.	Dec		G.M.A.	Dec		G.M.A.	Dec		G.M.A.	Dec		Name	S.M.A.	Dec.
18 00	86 29.6	190 02.1	S22 35.3	311 41.7	N20 30.2		354 35.1	N23 09.6		293 25.4	N12 34.3					Acamar	315 38.4	S40 23.8
01	101 32.0	205 01.2	35.7	326 44.3	30.4		9 37.9	09.6		308 27.9	34.4					Achernar	335 46.5	S57 21.2
02	116 34.5	220 00.2	36.1	341 46.9	30.5		24 40.8	09.6		323 30.3	34.4					Acruz	173 39.3	S62 58.3
03	131 37.0	234 59.3	36.5	356 49.6	30.7		39 43.6	09.6		338 32.8	34.4					Adhara	255 33.2	S28 56.6
04	146 39.4	249 58.4	36.9	11 52.2	30.8		54 46.4	09.6		353 35.3	34.4					Aldebaran	291 19.8	N16 27.9
05	161 41.9	264 57.5	37.3	26 54.8	31.0		69 49.3	09.6		8 37.8	34.4							
06	176 44.4	279 56.6	S22 37.7	41 57.4	N20 31.2		84 52.1	N23 09.6		23 40.3	N12 34.5					Alioth	166 44.4	N56 04.5
07	191 46.8	294 55.6	38.1	57 00.0	31.3		99 54.9	09.6		38 42.8	34.5					Alkaid	153 20.3	N49 25.2
08	206 49.3	309 54.7	38.4	72 02.7	31.5		114 57.8	09.6		53 45.3	34.5					Al Na'ir	28 17.6	S47 04.2
09	221 51.7	324 53.8	38.8	87 05.3	31.6		130 00.6	09.7		68 47.8	34.5					Alnilam	276 13.2	S 1 13.0
SUN 10	236 54.2	339 52.9	39.2	102 07.9	31.8		145 03.4	09.7		83 50.3	34.5					Alphard	218 22.2	S 8 33.8
11	251 56.7	354 52.0	39.6	117 10.5	32.0		160 06.2	09.7		98 52.8	34.6							
D 12	266 59.1	9 51.0	S22 40.0	132 13.2	N20 32.1		175 09.1	N23 09.7		113 55.3	N12 34.6					Alphecca	126 34.0	N26 47.3
13	282 01.6	24 50.1	40.3	147 15.8	32.3		190 11.9	09.7		128 57.7	34.6					Alpheratz	358 11.2	N28 58.3
14	297 04.1	39 49.2	40.7	162 18.4	32.5		205 14.7	09.7		144 00.2	34.6					Altair	62 34.6	N 8 48.7
15	312 06.5	54 48.3	41.1	177 21.1	32.6		220 17.6	09.7		159 02.7	34.7					Ankaa	353 42.1	S42 25.8
16	327 09.0	69 47.3	41.5	192 23.7	32.8		235 20.4	09.7		174 05.2	34.7					Antares	112 59.5	S26 22.9
17	342 11.5	84 46.4	41.8	207 26.3	32.9		250 23.2	09.7		189 07.7	34.7							
18	357 13.9	99 45.5	S22 42.2	222 29.0	N20 33.1		265 26.1	N23 09.7		204 10.2	N12 34.7					Arcturus	146 20.4	N19 17.8
19	12 16.4	114 44.6	42.6	237 31.6	33.3		280 28.9	09.8		219 12.7	34.7					Atria	108 25.9	S68 59.1
20	27 18.9	129 43.7	43.0	252 34.2	33.4		295 31.7	09.8		234 15.2	34.8					Avior	234 28.3	S59 26.3
21	42 21.3	144 42.7	43.3	267 36.9	33.6		310 34.6	09.8		249 17.7	34.8					Bellatrix	279 00.4	N 6 19.7
22	57 23.8	159 41.8	43.7	282 39.5	33.8		325 37.4	09.8		264 20.2	34.8					Betelgeuse	271 29.9	N 7 24.1
23	72 26.2	174 40.9	44.1	297 42.2	33.9		340 40.2	09.8		279 22.7	34.8							
19 00	87 28.7	189 40.0	S22 44.4	312 44.8	N20 34.1		355 43.1	N23 09.8		294 25.2	N12 34.8					Canopus	264 07.5	S52 41.1
01	102 31.2	204 39.0	44.8	327 47.5	34.3		10 45.9	09.8		309 27.7	34.9					Capella	281 13.5	N45 58.5
02	117 33.6	219 38.1	45.2	342 50.1	34.4		25 48.7	09.8		324 30.2	34.9					Deneb	49 50.0	N45 12.4
03	132 36.1	234 37.2	45.5	357 52.8	34.6		40 51.5	09.8		339 32.7	34.9					Denebola	183 00.9	N14 41.6
04	147 38.6	249 36.2	45.9	12 55.4	34.8		55 54.4	09.8		354 35.1	34.9					Diphda	349 22.7	S18 06.5
05	162 41.0	264 35.3	46.2	27 58.1	34.9		70 57.2	09.9		9 37.6	34.9							
06	177 43.5	279 34.4	S22 46.6	43 00.7	N20 35.1		86 00.0	N23 09.9		24 40.1	N12 35.0					Dubhe	194 24.4	N61 51.9
07	192 46.0	294 33.5	47.0	58 03.4	35.3		101 02.9	09.9		39 42.6	35.0					Elnath	278 46.1	N28 35.3
08	207 48.4	309 32.5	47.3	73 06.0	35.4		116 05.7	09.9		54 45.1	35.0					Eltanin	90 59.1	N51 29.6
M 09	222 50.9	324 31.6	47.7	88 08.7	35.6		131 08.5	09.9		69 47.6	35.0					Enif	34 13.6	N 9 46.6
O 10	237 53.3	339 30.7	48.0	103 11.3	35.8		146 11.4	09.9		84 50.1	35.1					Fomalhaut	15 53.6	S29 44.5
N 11	252 55.8	354 29.8	48.4	118 14.0	35.9		161 14.2	09.9		99 52.6	35.1							
D 12	267 58.3	9 28.8	S22 48.7	133 16.7	N20 36.1		176 17.0	N23 09.9		114 55.1	N12 35.1					Gacrux	172 30.8	S56 59.1
13	283 00.7	24 27.9	49.1	148 19.3	36.3		191 19.9	09.9		129 57.6	35.1					Gienah	176 19.9	S17 25.1
14	298 03.2	39 27.0	49.4	163 22.0	36.5		206 22.7	09.9		145 00.1	35.1					Hadar	149 26.2	S60 15.7
15	313 05.7	54 26.0	49.8	178 24.7	36.6		221 25.5	10.0		160 02.6	35.2					Hamal	328 30.8	N23 21.6
16	328 08.1	69 25.1	50.1	193 27.3	36.8		236 28.4	10.0		175 05.1	35.2					Kaus Aust.	84 19.7	S34 23.6
17	343 10.6	84 24.2	50.5	208 30.0	37.0		251 31.2	10.0		190 07.6	35.2							
18	358 13.1	99 23.2	S22 50.8	223 32.7	N20 37.1		266 34.0	N23 10.0		205 10.1	N12 35.2					Kochab	137 20.0	N74 14.6
19	13 15.5	114 22.3	51.1	238 35.4	37.3		281 36.9	10.0		220 12.6	35.3					Markab	14 05.1	N15 05.3
20	28 18.0	129 21.4	51.5	253 38.0	37.5		296 39.7	10.0		235 15.1	35.3					Menkar	314 42.8	N 4 00.2
21	43 20.5	144 20.5	51.8	268 40.7	37.7		311 42.5	10.0		250 17.6	35.3					Menkent	148 39.4	S36 15.5
22	58 22.9	159 19.5	52.2	283 43.4	37.8		326 45.4	10.0		265 20.1	35.3					Miaplacidus	221 44.6	S69 37.5
23	73 25.4	174 18.6	52.5	298 46.1	38.0		341 48.2	10.0		280 22.6	35.3							
20 00	88 27.8	189 17.7	S22 52.8	313 48.7	N20 38.2		356 51.0	N23 10.0		295 25.1	N12 35.4					Mirfak	309 18.3	N49 47.1
01	103 30.3	204 16.7	53.2	328 51.4	38.4		11 53.9	10.0		310 27.6	35.4					Nunki	76 31.8	S26 19.4
02	118 32.8	219 15.8	53.5	343 54.1	38.5		26 56.7	10.1		325 30.1	35.4					Peacock	54 01.9	S56 48.5
03	133 35.2	234 14.9	53.8	358 56.8	38.7		41 59.5	10.1		340 32.6	35.4					Pollux	244 00.1	N28 04.6
04	148 37.7	249 13.9	54.2	13 59.5	38.9		57 02.4	10.1		355 35.1	35.5					Procyon	245 27.4	N 5 16.8
05	163 40.2	264 13.0	54.5	29 02.2	39.1		72 05.2	10.1		10 37.6	35.5							
06	178 42.6	279 12.1	S22 54.8	44 04.9	N20 39.3		87 08.0	N23 10.1		25 40.1	N12 35.5					Rasalhague	96 31.7	N12 34.7
07	193 45.1	294 11.1	55.2	59 07.5	39.4		102 10.9	10.1		40 42.6	35.5					Regulus	208 11.8	N12 04.4
08	208 47.6	309 10.2	55.5	74 10.2	39.6		117 13.7	10.1		55 45.1	35.5					Rigel	281 37.5	S 8 13.7
09	223 50.0	324 09.3	55.8	89 12.9	39.8		132 16.5	10.1		70 47.6	35.6					Rigel Kent.	140 28.7	S60 44.3
10	238 52.5	339 08.3	56.1	104 15.6	40.0		147 19.3	10.1		85 50.1	35.6					Sabik	102 43.6	S15 41.8
11	253 55.0	354 07.4	56.5	119 18.3	40.1		162 22.2	10.1		100 52.6	35.6							
12	268 57.4	9 06.5	S22 56.8	134 21.0	N20 40.3		177 25.0	N23 10.2		115 55.1	N12 35.6					Schedar	350 10.9	N56 25.3
13	283 59.9	24 05.5	57.1	149 23.7	40.5		192 27.8	10.2		130 57.6	35.7					Shaula	96 58.7	S37 05.2
14	299 02.3	39 04.6	57.4	164 26.4	40.7		207 30.7	10.2		146 00.1	35.7					Sirius	258 57.0	S16 41.3
15	314 04.8	54 03.6	57.7	179 29.1	40.9		222 33.5	10.2		161 02.6	35.7					Spica	158 59.6	S11 02.7
16	329 07.3	69																

DECEMBER 18, 19, 20 (SUN., MON., TUES.)

G.M.T.	SUN				MOON				Lot.	Twilight			Moonrise			
	G.H.A.	Dec	G.H.A.	Dec	r	d	H.P.	Naut.		Civil	Sunrise	18	19	20	21	
18 00	180 53.9	S23 22.6	84 28.4	13.1	N 1	48.4	10.1	56.5	N 72	08 24	10 56	■	11 59	11 53	11 47	11 41
01	195 53.6	22.7	99 00.5	13.1	1	58.5	10.1	56.4	N 70	08 04	09 53	■	12 04	12 04	12 05	12 07
02	210 53.3	22.8	113 32.6	13.1	2	08.6	10.1	56.4	68	07 48	09 18	■	12 08	12 13	12 19	12 27
03	225 53.0	22.9	128 04.7	13.1	2	18.7	10.1	56.4	66	07 35	08 52	10 33	12 11	12 20	12 30	12 43
04	240 52.7	22.9	142 36.8	13.2	2	28.8	10.0	56.3	64	07 24	08 33	09 51	12 14	12 26	12 40	12 56
05	255 52.4	23.0	157 09.0	13.2	2	38.8	10.0	56.3	62	07 15	08 17	09 22	12 17	12 32	12 48	13 08
06	270 52.1	S23 23.1	171 41.2	13.2	N 2	48.8	10.0	56.3	60	07 06	08 03	09 01	12 19	12 36	12 55	13 17
07	285 51.8	23.2	186 13.4	13.2	2	58.8	10.0	56.2	N 58	06 59	07 51	08 43	12 21	12 40	13 02	13 26
08	300 51.5	23.2	200 45.6	13.3	3	08.8	9.9	56.2	56	06 52	07 41	08 28	12 23	12 44	13 07	13 33
09	315 51.2	23.3	215 17.9	13.2	3	18.7	9.9	56.2	54	06 46	07 32	08 16	12 24	12 48	13 12	13 40
10	330 50.9	23.4	229 50.1	13.3	3	28.6	9.9	56.1	52	06 40	07 24	08 05	12 26	12 51	13 17	13 45
11	345 50.6	23.5	244 22.4	13.4	3	38.5	9.9	56.1	50	06 35	07 16	07 55	12 27	12 53	13 21	13 51
12	0 50.3	S23 23.5	258 54.8	13.3	N 3	48.4	9.8	56.1	45	06 23	07 00	07 34	12 30	13 00	13 30	14 03
13	15 50.0	23.6	273 27.1	13.4	3	58.2	9.9	56.1	N 40	06 13	06 47	07 17	12 33	13 05	13 37	14 12
14	30 49.6	23.7	287 59.5	13.4	4	08.1	9.7	56.0	35	06 03	06 35	07 03	12 35	13 09	13 44	14 21
15	45 49.3	23.7	302 31.9	13.4	4	17.8	9.8	56.0	30	05 54	06 24	06 51	12 37	13 13	13 50	14 28
16	60 49.0	23.8	317 04.3	13.4	4	27.6	9.7	56.0	20	05 38	06 05	06 29	12 40	13 20	14 00	14 41
17	75 48.7	23.8	331 36.7	13.4	4	37.3	9.7	55.9	N 10	05 22	05 48	06 11	12 43	13 26	14 08	14 52
18	90 48.4	S23 23.9	346 09.1	13.4	N 4	47.0	9.7	55.9	0	05 05	05 31	05 53	12 46	13 32	14 17	15 02
19	105 48.1	24.0	0 41.5	13.5	4	56.7	9.6	55.9	S 10	04 46	05 13	05 36	12 49	13 37	14 25	15 13
20	120 47.8	24.0	15 14.0	13.5	5	06.3	9.6	55.8	20	04 23	04 52	05 17	12 52	13 43	14 34	15 24
21	135 47.5	24.1	29 46.5	13.5	5	15.9	9.5	55.8	30	03 54	04 27	04 55	12 56	13 50	14 44	15 37
22	150 47.2	24.2	44 19.0	13.5	5	25.4	9.6	55.8	35	03 35	04 12	04 42	12 58	13 55	14 50	15 45
23	165 46.9	24.2	58 51.5	13.5	5	35.0	9.5	55.8	40	03 12	03 54	04 27	13 00	13 59	14 57	15 53
19 00	180 46.6	S23 24.3	73 24.0	13.5	N 5	44.5	9.4	55.7	45	02 41	03 31	04 09	13 03	14 05	15 05	16 03
01	195 46.3	24.3	87 56.5	13.6	5	53.9	9.4	55.7	S 50	01 56	03 01	03 46	13 06	14 11	15 14	16 16
02	210 45.9	24.4	102 29.1	13.5	6	03.3	9.4	55.7	52	01 28	02 46	03 35	13 08	14 14	15 19	16 21
03	225 45.6	24.4	117 01.6	13.6	6	12.7	9.4	55.7	54	00 41	02 28	03 23	13 09	14 17	15 24	16 28
04	240 45.3	24.5	131 34.2	13.5	6	22.1	9.3	55.6	56		02 06	03 09	13 11	14 21	15 29	16 35
05	255 45.0	24.6	146 06.7	13.6	6	31.4	9.3	55.6	58		01 36	02 52	13 13	14 25	15 35	16 43
06	270 44.7	S23 24.6	160 39.3	13.6	N 6	40.7	9.2	55.6	S 60		00 46	02 31	13 15	14 30	15 42	16 52
07	285 44.4	24.7	175 11.9	13.6	6	49.9	9.2	55.5								
08	300 44.1	24.7	189 44.5	13.6	6	59.1	9.2	55.5								
09	315 43.8	24.8	204 17.1	13.6	7	08.3	9.1	55.5								
10	330 43.5	24.8	218 49.7	13.6	7	17.4	9.1	55.5								
11	345 43.2	24.9	233 22.3	13.6	7	26.5	9.0	55.4								
12	0 42.9	S23 24.9	247 54.9	13.6	N 7	35.5	9.0	55.4								
13	15 42.5	25.0	262 27.5	13.6	7	44.5	9.0	55.4								
14	30 42.2	25.0	277 00.1	13.6	7	53.5	8.9	55.4								
15	45 41.9	25.1	291 32.7	13.7	8	02.4	8.9	55.3								
16	60 41.6	25.1	306 05.4	13.6	8	11.3	8.8	55.3								
17	75 41.3	25.2	320 38.0	13.6	8	20.1	8.8	55.3								
18	90 41.0	S23 25.2	335 10.6	13.6	N 8	28.9	8.7	55.3								
19	105 40.7	25.2	349 43.2	13.7	8	37.6	8.7	55.3								
20	120 40.4	25.3	4 15.9	13.6	8	46.3	8.7	55.2								
21	135 40.1	25.3	18 48.5	13.6	8	55.0	8.6	55.2								
22	150 39.8	25.4	33 21.1	13.7	9	03.6	8.6	55.2								
23	165 39.5	25.4	47 53.8	13.6	9	12.2	8.5	55.2								
20 00	180 39.1	S23 25.4	62 26.4	13.6	N 9	20.7	8.4	55.1								
01	195 38.8	25.5	76 59.0	13.6	9	29.1	8.4	55.1								
02	210 38.5	25.5	91 31.6	13.6	9	37.5	8.4	55.1								
03	225 38.2	25.6	106 04.2	13.6	9	45.9	8.3	55.1								
04	240 37.9	25.6	120 36.8	13.6	9	54.2	8.3	55.1								
05	255 37.6	25.6	135 09.4	13.6	10	02.5	8.2	55.0								
06	270 37.3	S23 25.7	149 42.0	13.6	N 10	10.7	8.2	55.0								
07	285 37.0	25.7	164 14.6	13.6	10	18.9	8.1	55.0								
08	300 36.7	25.7	178 47.2	13.6	10	27.0	8.1	55.0								
09	315 36.4	25.8	193 19.8	13.6	10	35.1	8.0	54.9								
10	330 36.1	25.8	207 52.4	13.6	10	43.1	8.0	54.9								
11	345 35.7	25.8	222 25.0	13.5	10	51.1	7.9	54.9								
12	0 35.4	S23 25.9	236 57.5	13.6	N 10	59.0	7.8	54.9								
13	15 35.1	25.9	251 30.1	13.5	11	06.8	7.8	54.9								
14	30 34.8	25.9	266 02.6	13.6	11	14.6	7.8	54.9								
15	45 34.5	25.9	280 35.2	13.5	11	22.4	7.7	54.8								
16	60 34.2	26.0	295 07.7	13.5	11	30.1	7.6	54.8								
17	75 33.9	26.0	309 40.2	13.5	11	37.7	7.6	54.8								
18	90 33.6	S23 26.0	324 12.7	13.5	N 11	45.3	7.5	54.8								
19	105 33.3	26.0	338 45.2	13.5	11	52.8	7.5	54.8								
20	120 33.0	26.1	353 17.7	13.5	12	00.3	7.4	54.7								
21	135 32.6	26.1	7 50.2	13.4	12	07.7	7.4	54.7								
22	150 32.3	26.1	22 22.6	13.5	12	15.1	7.3	54.7								
23	165 32.0	26.1	36 55.1	13.4	12	22.4	7.2	54.7								
	S.D. 16.3	d 00	S.D. 15.3	15.1	15.0											

Day	SUN			MOON			
	Eqn. of Time	Mer. Pass.	Mer. Pass.	Upper	Lower	Age	Phase
18	03 36	03 22	11 57	18 57	06 34	08	☾
19	03 07	02 52	11 57	19 42	07 20	09	
20	02 37	02 22	11 58	20 28	08 05	10	

18 <sup>m</sup>	SUN PLANETS	ARIES	MOON	v or Corr <sup>n</sup>			19 <sup>m</sup>	SUN PLANETS	ARIES	MOON	v or Corr <sup>n</sup>				
				v	or	Corr <sup>n</sup>					v	or	Corr <sup>n</sup>		
00	4 300	4 307	4 177	0-0	0-0	6-0 1-9	12-0 3-7	00	4 450	4 458	4 320	0-0	0-0	6-0 2-0	12-0 3-9
01	4 303	4 310	4 179	0-1	0-0	6-1 1-9	12-1 3-7	01	4 453	4 460	4 323	0-1	0-0	6-1 2-0	12-1 3-9
02	4 305	4 312	4 182	0-2	0-1	6-2 1-9	12-2 3-8	02	4 455	4 463	4 325	0-2	0-1	6-2 2-0	12-2 4-0
03	4 308	4 315	4 184	0-3	0-1	6-3 1-9	12-3 3-8	03	4 458	4 465	4 327	0-3	0-1	6-3 2-0	12-3 4-0
04	4 310	4 317	4 187	0-4	0-1	6-4 2-0	12-4 3-8	04	4 460	4 468	4 330	0-4	0-1	6-4 2-1	12-4 4-0
05	4 313	4 320	4 189	0-5	0-2	6-5 2-0	12-5 3-9	05	4 463	4 470	4 332	0-5	0-2	6-5 2-1	12-5 4-1
06	4 315	4 322	4 191	0-6	0-2	6-6 2-0	12-6 3-9	06	4 465	4 473	4 334	0-6	0-2	6-6 2-1	12-6 4-1
07	4 318	4 325	4 194	0-7	0-2	6-7 2-1	12-7 3-9	07	4 468	4 475	4 337	0-7	0-2	6-7 2-2	12-7 4-1
08	4 320	4 327	4 196	0-8	0-2	6-8 2-1	12-8 3-9	08	4 470	4 478	4 339	0-8	0-3	6-8 2-2	12-8 4-2
09	4 323	4 330	4 198	0-9	0-3	6-9 2-1	12-9 4-0	09	4 473	4 480	4 342	0-9	0-3	6-9 2-2	12-9 4-2
10	4 325	4 332	4 201	1-0	0-3	7-0 2-2	13-0 4-0	10	4 475	4 483	4 344	1-0	0-3	7-0 2-3	13-0 4-2
11	4 328	4 335	4 203	1-1	0-3	7-1 2-2	13-1 4-0	11	4 478	4 485	4 346	1-1	0-4	7-1 2-3	13-1 4-3
12	4 330	4 337	4 206	1-2	0-4	7-2 2-2	13-2 4-1	12	4 480	4 488	4 349	1-2	0-4	7-2 2-3	13-2 4-3
13	4 333	4 340	4 208	1-3	0-4	7-3 2-3	13-3 4-1	13	4 483	4 490	4 351	1-3	0-4	7-3 2-4	13-3 4-3
14	4 335	4 342	4 210	1-4	0-4	7-4 2-3	13-4 4-1	14	4 485	4 493	4 354	1-4	0-5	7-4 2-4	13-4 4-4
15	4 338	4 345	4 213	1-5	0-5	7-5 2-3	13-5 4-2	15	4 488	4 495	4 356	1-5	0-5	7-5 2-4	13-5 4-4
16	4 340	4 348	4 215	1-6	0-5	7-6 2-3	13-6 4-2	16	4 490	4 498	4 358	1-6	0-5	7-6 2-5	13-6 4-4
17	4 343	4 350	4 218	1-7	0-5	7-7 2-4	13-7 4-2	17	4 493	4 500	4 361	1-7	0-6	7-7 2-5	13-7 4-5
18	4 345	4 353	4 220	1-8	0-6	7-8 2-4	13-8 4-3	18	4 495	4 503	4 363	1-8	0-6	7-8 2-5	13-8 4-5
19	4 348	4 355	4 222	1-9	0-6	7-9 2-4	13-9 4-3	19	4 498	4 505	4 366	1-9	0-6	7-9 2-6	13-9 4-5
20	4 350	4 358	4 225	2-0	0-6	8-0 2-5	14-0 4-3	20	4 500	4 508	4 368	2-0	0-7	8-0 2-6	14-0 4-6
21	4 353	4 360	4 227	2-1	0-6	8-1 2-5	14-1 4-3	21	4 503	4 510	4 370	2-1	0-7	8-1 2-6	14-1 4-6
22	4 355	4 363	4 229	2-2	0-7	8-2 2-5	14-2 4-4	22	4 505	4 513	4 373	2-2	0-7	8-2 2-7	14-2 4-6
23	4 358	4 365	4 232	2-3	0-7	8-3 2-6	14-3 4-4	23	4 508	4 515	4 375	2-3	0-7	8-3 2-7	14-3 4-6
24	4 360	4 368	4 234	2-4	0-7	8-4 2-6	14-4 4-4	24	4 510	4 518	4 377	2-4	0-8	8-4 2-7	14-4 4-7
25	4 363	4 370	4 237	2-5	0-8	8-5 2-6	14-5 4-5	25	4 513	4 520	4 380	2-5	0-8	8-5 2-8	14-5 4-7
26	4 365	4 373	4 239	2-6	0-8	8-6 2-7	14-6 4-5	26	4 515	4 523	4 382	2-6	0-8	8-6 2-8	14-6 4-7
27	4 368	4 375	4 241	2-7	0-8	8-7 2-7	14-7 4-5	27	4 518	4 525	4 385	2-7	0-9	8-7 2-8	14-7 4-8
28	4 370	4 378	4 244	2-8	0-9	8-8 2-7	14-8 4-6	28	4 520	4 528	4 387	2-8	0-9	8-8 2-9	14-8 4-8
29	4 373	4 380	4 246	2-9	0-9	8-9 2-7	14-9 4-6	29	4 523	4 531	4 389	2-9	0-9	8-9 2-9	14-9 4-8
30	4 375	4 383	4 249	3-0	0-9	9-0 2-8	15-0 4-6	30	4 525	4 533	4 392	3-0	1-0	9-0 2-9	15-0 4-9
31	4 378	4 385	4 251	3-1	1-0	9-1 2-8	15-1 4-7	31	4 528	4 536	4 394	3-1	1-0	9-1 3-0	15-1 4-9
32	4 380	4 388	4 253	3-2	1-0	9-2 2-8	15-2 4-7	32	4 530	4 538	4 397	3-2	1-0	9-2 3-0	15-2 4-9
33	4 383	4 390	4 256	3-3	1-0	9-3 2-9	15-3 4-7	33	4 533	4 541	4 399	3-3	1-1	9-3 3-0	15-3 5-0
34	4 385	4 393	4 258	3-4	1-0	9-4 2-9	15-4 4-7	34	4 535	4 543	4 401	3-4	1-1	9-4 3-1	15-4 5-0
35	4 388	4 395	4 261	3-5	1-1	9-5 2-9	15-5 4-8	35	4 538	4 546	4 404	3-5	1-1	9-5 3-1	15-5 5-0
36	4 390	4 398	4 263	3-6	1-1	9-6 3-0	15-6 4-8	36	4 540	4 548	4 406	3-6	1-2	9-6 3-1	15-6 5-1
37	4 393	4 400	4 265	3-7	1-1	9-7 3-0	15-7 4-8	37	4 543	4 551	4 408	3-7	1-2	9-7 3-2	15-7 5-1
38	4 395	4 403	4 268	3-8	1-2	9-8 3-0	15-8 4-9	38	4 545	4 553	4 411	3-8	1-2	9-8 3-2	15-8 5-1
39	4 398	4 405	4 270	3-9	1-2	9-9 3-1	15-9 4-9	39	4 548	4 556	4 413	3-9	1-3	9-9 3-2	15-9 5-2
40	4 400	4 408	4 272	4-0	1-2	10-0 3-1	16-0 4-9	40	4 550	4 558	4 416	4-0	1-3	10-0 3-3	16-0 5-2
41	4 403	4 410	4 275	4-1	1-3	10-1 3-1	16-1 5-0	41	4 553	4 561	4 418	4-1	1-3	10-1 3-3	16-1 5-2
42	4 405	4 413	4 277	4-2	1-3	10-2 3-1	16-2 5-0	42	4 555	4 563	4 420	4-2	1-4	10-2 3-3	16-2 5-3
43	4 408	4 415	4 280	4-3	1-3	10-3 3-2	16-3 5-0	43	4 558	4 566	4 423	4-3	1-4	10-3 3-3	16-3 5-3
44	4 410	4 418	4 282	4-4	1-4	10-4 3-2	16-4 5-1	44	4 560	4 568	4 425	4-4	1-4	10-4 3-4	16-4 5-3
45	4 413	4 420	4 284	4-5	1-4	10-5 3-2	16-5 5-1	45	4 563	4 571	4 428	4-5	1-5	10-5 3-4	16-5 5-4
46	4 415	4 423	4 287	4-6	1-4	10-6 3-3	16-6 5-1	46	4 565	4 573	4 430	4-6	1-5	10-6 3-4	16-6 5-4
47	4 418	4 425	4 289	4-7	1-4	10-7 3-3	16-7 5-1	47	4 568	4 576	4 432	4-7	1-5	10-7 3-5	16-7 5-4
48	4 420	4 428	4 292	4-8	1-5	10-8 3-3	16-8 5-2	48	4 570	4 578	4 435	4-8	1-6	10-8 3-5	16-8 5-5
49	4 423	4 430	4 294	4-9	1-5	10-9 3-4	16-9 5-2	49	4 573	4 581	4 437	4-9	1-6	10-9 3-5	16-9 5-5
50	4 425	4 433	4 296	5-0	1-5	11-0 3-4	17-0 5-2	50	4 575	4 583	4 439	5-0	1-6	11-0 3-6	17-0 5-5
51	4 428	4 435	4 299	5-1	1-6	11-1 3-4	17-1 5-3	51	4 578	4 586	4 442	5-1	1-7	11-1 3-6	17-1 5-6
52	4 430	4 438	4 301	5-2	1-6	11-2 3-5	17-2 5-3	52	4 580	4 588	4 444	5-2	1-7	11-2 3-6	17-2 5-6
53	4 433	4 440	4 303	5-3	1-6	11-3 3-5	17-3 5-3	53	4 583	4 591	4 447	5-3	1-7	11-3 3-7	17-3 5-6
54	4 435	4 443	4 306	5-4	1-7	11-4 3-5	17-4 5-4	54	4 585	4 593	4 449	5-4	1-8	11-4 3-7	17-4 5-7
55	4 438	4 445	4 308	5-5	1-7	11-5 3-5	17-5 5-4	55	4 588	4 596	4 451	5-5	1-8	11-5 3-7	17-5 5-7
56	4 440	4 448	4 311	5-6	1-7	11-6 3-6	17-6 5-4	56	4 590	4 598	4 454	5-6	1-8	11-6 3-8	17-6 5-7
57	4 443	4 450	4 313	5-7	1-8	11-7 3-6	17-7 5-5	57	4 593	5 001	4 456	5-7	1-9	11-7 3-8	17-7 5-8
58	4 445	4 453	4 315	5-8	1-8	11-8 3-6	17-8 5-5	58	4 595	5 003	4 459	5-8	1-9	11-8 3-8	17-8 5-8
59	4 448	4 455	4 318	5-9	1-8	11-9 3-7	17-9 5-5	59	4 598	5 006	4 461	5-9	1-9	11-9 3-9	17-9 5-8
60	4 450	4 458	4 320	6-0	1-9	12-0 3-7	18-0 5-6	60	5 000	5 008	4 463	6-0	2-0	12-0 3-9	18-0 5-9

20	SUN PLANETS	ARIES	MOON	° or Corr		° or Corr		° or Corr		21	SUN PLANETS	ARIES	MOON	° or Corr		° or Corr		° or Corr	
				d	'	d	'	d	'					d	'	d	'	d	'
00	5 00-0	5 00-8	4 46-3	0-0	0-0	6-0	2-1	12-0	4-1	00	5 15-0	5 15-9	5 00-7	0-0	0-0	6-0	2-2	12-0	4-3
01	5 00-3	5 01-1	4 46-6	0-1	0-0	6-1	2-1	12-1	4-1	01	5 15-3	5 16-1	5 00-9	0-1	0-0	6-1	2-2	12-1	4-3
02	5 00-5	5 01-3	4 46-8	0-2	0-1	6-2	2-1	12-2	4-2	02	5 15-5	5 16-4	5 01-1	0-2	0-1	6-2	2-2	12-2	4-4
03	5 00-8	5 01-6	4 47-0	0-3	0-1	6-3	2-2	12-3	4-2	03	5 15-8	5 16-6	5 01-4	0-3	0-1	6-3	2-3	12-3	4-4
04	5 01-0	5 01-8	4 47-3	0-4	0-1	6-4	2-2	12-4	4-2	04	5 16-0	5 16-9	5 01-6	0-4	0-1	6-4	2-3	12-4	4-4
05	5 01-3	5 02-1	4 47-5	0-5	0-2	6-5	2-2	12-5	4-3	05	5 16-3	5 17-1	5 01-8	0-5	0-2	6-5	2-3	12-5	4-5
06	5 01-5	5 02-3	4 47-8	0-6	0-2	6-6	2-3	12-6	4-3	06	5 16-5	5 17-4	5 02-1	0-6	0-2	6-6	2-4	12-6	4-5
07	5 01-8	5 02-6	4 48-0	0-7	0-2	6-7	2-3	12-7	4-3	07	5 16-8	5 17-6	5 02-3	0-7	0-3	6-7	2-4	12-7	4-6
08	5 02-0	5 02-8	4 48-2	0-8	0-3	6-8	2-3	12-8	4-4	08	5 17-0	5 17-9	5 02-6	0-8	0-3	6-8	2-4	12-8	4-6
09	5 02-3	5 03-1	4 48-5	0-9	0-3	6-9	2-4	12-9	4-4	09	5 17-3	5 18-1	5 02-8	0-9	0-3	6-9	2-5	12-9	4-6
10	5 02-5	5 03-3	4 48-7	1-0	0-3	7-0	2-4	13-0	4-4	10	5 17-5	5 18-4	5 03-0	1-0	0-4	7-0	2-5	13-0	4-7
11	5 02-8	5 03-6	4 49-0	1-1	0-4	7-1	2-4	13-1	4-5	11	5 17-8	5 18-6	5 03-3	1-1	0-4	7-1	2-5	13-1	4-7
12	5 03-0	5 03-8	4 49-2	1-2	0-4	7-2	2-5	13-2	4-5	12	5 18-0	5 18-9	5 03-5	1-2	0-4	7-2	2-6	13-2	4-7
13	5 03-3	5 04-1	4 49-4	1-3	0-4	7-3	2-5	13-3	4-5	13	5 18-3	5 19-1	5 03-8	1-3	0-5	7-3	2-6	13-3	4-8
14	5 03-5	5 04-3	4 49-7	1-4	0-5	7-4	2-5	13-4	4-6	14	5 18-5	5 19-4	5 04-0	1-4	0-5	7-4	2-7	13-4	4-8
15	5 03-8	5 04-6	4 49-9	1-5	0-5	7-5	2-6	13-5	4-6	15	5 18-8	5 19-6	5 04-2	1-5	0-5	7-5	2-7	13-5	4-8
16	5 04-0	5 04-8	4 50-2	1-6	0-5	7-6	2-6	13-6	4-6	16	5 19-0	5 19-9	5 04-5	1-6	0-6	7-6	2-7	13-6	4-9
17	5 04-3	5 05-1	4 50-4	1-7	0-6	7-7	2-6	13-7	4-7	17	5 19-3	5 20-1	5 04-7	1-7	0-6	7-7	2-8	13-7	4-9
18	5 04-5	5 05-3	4 50-6	1-8	0-6	7-8	2-7	13-8	4-7	18	5 19-5	5 20-4	5 04-9	1-8	0-6	7-8	2-8	13-8	4-9
19	5 04-8	5 05-6	4 50-9	1-9	0-6	7-9	2-7	13-9	4-7	19	5 19-8	5 20-6	5 05-2	1-9	0-7	7-9	2-8	13-9	5-0
20	5 05-0	5 05-8	4 51-1	2-0	0-7	8-0	2-7	14-0	4-8	20	5 20-0	5 20-9	5 05-4	2-0	0-7	8-0	2-9	14-0	5-0
21	5 05-3	5 06-1	4 51-3	2-1	0-7	8-1	2-8	14-1	4-8	21	5 20-3	5 21-1	5 05-7	2-1	0-8	8-1	2-9	14-1	5-1
22	5 05-5	5 06-3	4 51-6	2-2	0-8	8-2	2-8	14-2	4-9	22	5 20-5	5 21-4	5 05-9	2-2	0-8	8-2	2-9	14-2	5-1
23	5 05-8	5 06-6	4 51-8	2-3	0-8	8-3	2-8	14-3	4-9	23	5 20-8	5 21-6	5 06-1	2-3	0-8	8-3	3-0	14-3	5-1
24	5 06-0	5 06-8	4 52-1	2-4	0-8	8-4	2-9	14-4	4-9	24	5 21-0	5 21-9	5 06-4	2-4	0-9	8-4	3-0	14-4	5-2
25	5 06-3	5 07-1	4 52-3	2-5	0-9	8-5	2-9	14-5	5-0	25	5 21-3	5 22-1	5 06-6	2-5	0-9	8-5	3-0	14-5	5-2
26	5 06-5	5 07-3	4 52-5	2-6	0-9	8-6	2-9	14-6	5-0	26	5 21-5	5 22-4	5 06-9	2-6	0-9	8-6	3-1	14-6	5-2
27	5 06-8	5 07-6	4 52-8	2-7	0-9	8-7	3-0	14-7	5-0	27	5 21-8	5 22-6	5 07-1	2-7	1-0	8-7	3-1	14-7	5-3
28	5 07-0	5 07-8	4 53-0	2-8	1-0	8-8	3-0	14-8	5-1	28	5 22-0	5 22-9	5 07-3	2-8	1-0	8-8	3-2	14-8	5-3
29	5 07-3	5 08-1	4 53-3	2-9	1-0	8-9	3-0	14-9	5-1	29	5 22-3	5 23-1	5 07-6	2-9	1-0	8-9	3-2	14-9	5-3
30	5 07-5	5 08-3	4 53-5	3-0	1-0	9-0	3-1	15-0	5-1	30	5 22-5	5 23-4	5 07-8	3-0	1-1	9-0	3-2	15-0	5-4
31	5 07-8	5 08-6	4 53-7	3-1	1-1	9-1	3-1	15-1	5-2	31	5 22-8	5 23-6	5 08-0	3-1	1-1	9-1	3-3	15-1	5-4
32	5 08-0	5 08-8	4 54-0	3-2	1-1	9-2	3-1	15-2	5-2	32	5 23-0	5 23-9	5 08-3	3-2	1-1	9-2	3-3	15-2	5-4
33	5 08-3	5 09-1	4 54-2	3-3	1-1	9-3	3-2	15-3	5-2	33	5 23-3	5 24-1	5 08-5	3-3	1-2	9-3	3-3	15-3	5-5
34	5 08-5	5 09-3	4 54-4	3-4	1-2	9-4	3-2	15-4	5-3	34	5 23-5	5 24-4	5 08-8	3-4	1-2	9-4	3-4	15-4	5-5
35	5 08-8	5 09-6	4 54-7	3-5	1-2	9-5	3-2	15-5	5-3	35	5 23-8	5 24-6	5 09-0	3-5	1-3	9-5	3-4	15-5	5-6
36	5 09-0	5 09-8	4 54-9	3-6	1-2	9-6	3-3	15-6	5-3	36	5 24-0	5 24-9	5 09-2	3-6	1-3	9-6	3-4	15-6	5-6
37	5 09-3	5 10-1	4 55-2	3-7	1-3	9-7	3-3	15-7	5-4	37	5 24-3	5 25-1	5 09-5	3-7	1-3	9-7	3-5	15-7	5-6
38	5 09-5	5 10-3	4 55-4	3-8	1-3	9-8	3-3	15-8	5-4	38	5 24-5	5 25-4	5 09-7	3-8	1-4	9-8	3-5	15-8	5-7
39	5 09-8	5 10-6	4 55-6	3-9	1-3	9-9	3-4	15-9	5-4	39	5 24-8	5 25-6	5 10-0	3-9	1-4	9-9	3-5	15-9	5-7
40	5 10-0	5 10-8	4 55-9	4-0	1-4	10-0	3-4	16-0	5-5	40	5 25-0	5 25-9	5 10-2	4-0	1-4	10-0	3-6	16-0	5-7
41	5 10-3	5 11-1	4 56-1	4-1	1-4	10-1	3-5	16-1	5-5	41	5 25-3	5 26-1	5 10-4	4-1	1-5	10-1	3-6	16-1	5-8
42	5 10-5	5 11-4	4 56-4	4-2	1-4	10-2	3-5	16-2	5-5	42	5 25-5	5 26-4	5 10-7	4-2	1-5	10-2	3-7	16-2	5-8
43	5 10-8	5 11-6	4 56-6	4-3	1-5	10-3	3-5	16-3	5-6	43	5 25-8	5 26-6	5 10-9	4-3	1-5	10-3	3-7	16-3	5-8
44	5 11-0	5 11-9	4 56-8	4-4	1-5	10-4	3-6	16-4	5-6	44	5 26-0	5 26-9	5 11-1	4-4	1-6	10-4	3-7	16-4	5-9
45	5 11-3	5 12-1	4 57-1	4-5	1-5	10-5	3-6	16-5	5-6	45	5 26-3	5 27-1	5 11-4	4-5	1-6	10-5	3-8	16-5	5-9
46	5 11-5	5 12-4	4 57-3	4-6	1-6	10-6	3-6	16-6	5-7	46	5 26-5	5 27-4	5 11-6	4-6	1-6	10-6	3-8	16-6	5-9
47	5 11-8	5 12-6	4 57-5	4-7	1-6	10-7	3-7	16-7	5-7	47	5 26-8	5 27-6	5 11-9	4-7	1-7	10-7	3-8	16-7	6-0
48	5 12-0	5 12-9	4 57-8	4-8	1-6	10-8	3-7	16-8	5-7	48	5 27-0	5 27-9	5 12-1	4-8	1-7	10-8	3-9	16-8	6-0
49	5 12-3	5 13-1	4 58-0	4-9	1-7	10-9	3-7	16-9	5-8	49	5 27-3	5 28-1	5 12-3	4-9	1-8	10-9	3-9	16-9	6-1
50	5 12-5	5 13-4	4 58-3	5-0	1-7	11-0	3-8	17-0	5-8	50	5 27-5	5 28-4	5 12-6	5-0	1-8	11-0	3-9	17-0	6-1
51	5 12-8	5 13-6	4 58-5	5-1	1-7	11-1	3-8	17-1	5-8	51	5 27-8	5 28-6	5 12-8	5-1	1-8	11-1	4-0	17-1	6-1
52	5 13-0	5 13-9	4 58-7	5-2	1-8	11-2	3-8	17-2	5-9	52	5 28-0	5 28-9	5 13-1	5-2	1-9	11-2	4-0	17-2	6-2
53	5 13-3	5 14-1	4 59-0	5-3	1-8	11-3	3-9	17-3	5-9	53	5 28-3	5 29-1	5 13-3	5-3	1-9	11-3	4-0	17-3	6-2
54	5 13-5	5 14-4	4 59-2	5-4	1-8	11-4	3-9	17-4	5-9	54	5 28-5	5 29-4	5 13-5	5-4	1-9	11-4	4-1	17-4	6-2
55	5 13-8	5 14-6	4 59-5	5-5	1-9	11-5	3-9	17-5	6-0	55	5 28-8	5 29-7	5 13-8	5-5	2-0	11-5	4-1	17-5	6-3
56	5 14-0	5 14-9	4 59-7	5-6	1-9	11-6	4-0	17-6	6-0	56	5 29-0	5 29-9	5 14-0	5-6	2-0	11-6	4-2	17-6	6-3
57	5 14-3	5 15-1	4 59-9	5-7	1-9	11-7	4-0	17-7	6-0	57	5 29-3	5 30-2	5 14-3	5-7	2-0	11-7	4-2	17-7	6-3
58	5 14-5	5 15-4	5 00-2	5-8	2-0	11-8	4-0	17-8	6-1	58	5 29-5	5 30-4	5 14-5	5-8	2-1	11-8	4-2	17-8	6-4
59	5 14-8	5 15-6	5 00-4	5-9	2-0	11-9	4-1	17-9	6-1	59	5 29-8	5 30-7	5 14-7	5-9	2-1	11-9	4-3	17-9	6-4
60	5 15-0	5 15-9	5 00-7	6-0	2-1	12-0	4-1	18-0	6-2	60	5 30-0	5 30-9	5 15-0	6-0	2-2	12-0	4-3	18-0	6-5

26 <sup>m</sup>	SUN PLANETS	ARIES	MOON	Corr <sup>n</sup>		Corr <sup>n</sup>		Corr <sup>n</sup>		27 <sup>m</sup>	SUN PLANETS	ARIES	MOON	Corr <sup>n</sup>		Corr <sup>n</sup>		Corr <sup>n</sup>	
				or	d	or	d	or	d					or	d	or	d	or	d
00	6 300	6 311	6 122	0-0	00	6-0	2-7	12-0	53	00	6 450	6 461	6 266	0-0	00	6-0	2-8	12-0	55
01	6 303	6 313	6 125	0-1	00	6-1	2-7	12-1	53	01	6 453	6 464	6 268	0-1	00	6-1	2-8	12-1	55
02	6 305	6 316	6 127	0-2	01	6-2	2-7	12-2	54	02	6 455	6 466	6 270	0-2	01	6-2	2-8	12-2	56
03	6 308	6 318	6 129	0-3	01	6-3	2-8	12-3	54	03	6 458	6 469	6 273	0-3	01	6-3	2-9	12-3	56
04	6 310	6 321	6 132	0-4	02	6-4	2-8	12-4	55	04	6 460	6 471	6 275	0-4	02	6-4	2-9	12-4	57
05	6 313	6 323	6 134	0-5	02	6-5	2-9	12-5	55	05	6 463	6 474	6 277	0-5	02	6-5	3-0	12-5	57
06	6 315	6 326	6 137	0-6	03	6-6	2-9	12-6	56	06	6 465	6 476	6 280	0-6	03	6-6	3-0	12-6	58
07	6 318	6 328	6 139	0-7	03	6-7	3-0	12-7	56	07	6 468	6 479	6 282	0-7	03	6-7	3-1	12-7	58
08	6 320	6 331	6 141	0-8	04	6-8	3-0	12-8	57	08	6 470	6 481	6 285	0-8	04	6-8	3-1	12-8	59
09	6 323	6 333	6 144	0-9	04	6-9	3-0	12-9	57	09	6 473	6 484	6 287	0-9	04	6-9	3-2	12-9	59
10	6 325	6 336	6 146	1-0	04	7-0	3-1	13-0	57	10	6 475	6 486	6 289	1-0	05	7-0	3-2	13-0	60
11	6 328	6 338	6 149	1-1	05	7-1	3-1	13-1	58	11	6 478	6 489	6 292	1-1	05	7-1	3-3	13-1	60
12	6 330	6 341	6 151	1-2	05	7-2	3-2	13-2	58	12	6 480	6 491	6 294	1-2	06	7-2	3-3	13-2	61
13	6 333	6 343	6 153	1-3	06	7-3	3-2	13-3	59	13	6 483	6 494	6 297	1-3	06	7-3	3-3	13-3	61
14	6 335	6 346	6 156	1-4	06	7-4	3-3	13-4	59	14	6 485	6 496	6 299	1-4	06	7-4	3-4	13-4	61
15	6 338	6 348	6 158	1-5	07	7-5	3-3	13-5	60	15	6 488	6 499	6 301	1-5	07	7-5	3-4	13-5	62
16	6 340	6 351	6 161	1-6	07	7-6	3-4	13-6	60	16	6 490	6 501	6 304	1-6	07	7-6	3-5	13-6	62
17	6 343	6 353	6 163	1-7	08	7-7	3-4	13-7	61	17	6 493	6 504	6 306	1-7	08	7-7	3-5	13-7	63
18	6 345	6 356	6 165	1-8	08	7-8	3-4	13-8	61	18	6 495	6 506	6 308	1-8	08	7-8	3-6	13-8	63
19	6 348	6 358	6 168	1-9	08	7-9	3-5	13-9	61	19	6 498	6 509	6 311	1-9	09	7-9	3-6	13-9	64
20	6 350	6 361	6 170	2-0	09	8-0	3-5	14-0	62	20	6 500	6 511	6 313	2-0	09	8-0	3-7	14-0	64
21	6 353	6 363	6 172	2-1	09	8-1	3-6	14-1	62	21	6 503	6 514	6 316	2-1	10	8-1	3-7	14-1	65
22	6 355	6 366	6 175	2-2	10	8-2	3-6	14-2	63	22	6 505	6 516	6 318	2-2	10	8-2	3-8	14-2	65
23	6 358	6 368	6 177	2-3	10	8-3	3-7	14-3	63	23	6 508	6 519	6 320	2-3	11	8-3	3-8	14-3	66
24	6 360	6 371	6 180	2-4	11	8-4	3-7	14-4	64	24	6 510	6 521	6 323	2-4	11	8-4	3-9	14-4	66
25	6 363	6 373	6 182	2-5	11	8-5	3-8	14-5	64	25	6 513	6 524	6 325	2-5	11	8-5	3-9	14-5	66
26	6 365	6 376	6 184	2-6	11	8-6	3-8	14-6	64	26	6 515	6 526	6 328	2-6	12	8-6	3-9	14-6	67
27	6 368	6 378	6 187	2-7	12	8-7	3-8	14-7	65	27	6 518	6 529	6 330	2-7	12	8-7	4-0	14-7	67
28	6 370	6 381	6 189	2-8	12	8-8	3-9	14-8	65	28	6 520	6 531	6 332	2-8	13	8-8	4-0	14-8	68
29	6 373	6 383	6 192	2-9	13	8-9	3-9	14-9	66	29	6 523	6 534	6 335	2-9	13	8-9	4-1	14-9	68
30	6 375	6 386	6 194	3-0	13	9-0	4-0	15-0	66	30	6 525	6 536	6 337	3-0	14	9-0	4-1	15-0	69
31	6 378	6 388	6 196	3-1	14	9-1	4-0	15-1	67	31	6 528	6 539	6 339	3-1	14	9-1	4-2	15-1	69
32	6 380	6 391	6 199	3-2	14	9-2	4-1	15-2	67	32	6 530	6 541	6 342	3-2	15	9-2	4-2	15-2	70
33	6 383	6 393	6 201	3-3	15	9-3	4-1	15-3	68	33	6 533	6 544	6 344	3-3	15	9-3	4-3	15-3	70
34	6 385	6 396	6 203	3-4	15	9-4	4-2	15-4	68	34	6 535	6 546	6 347	3-4	16	9-4	4-3	15-4	71
35	6 388	6 398	6 206	3-5	15	9-5	4-2	15-5	68	35	6 538	6 549	6 349	3-5	16	9-5	4-4	15-5	71
36	6 390	6 401	6 208	3-6	16	9-6	4-2	15-6	69	36	6 540	6 551	6 351	3-6	17	9-6	4-4	15-6	72
37	6 393	6 403	6 211	3-7	16	9-7	4-3	15-7	69	37	6 543	6 554	6 354	3-7	17	9-7	4-4	15-7	72
38	6 395	6 406	6 213	3-8	17	9-8	4-3	15-8	70	38	6 545	6 556	6 356	3-8	17	9-8	4-5	15-8	72
39	6 398	6 408	6 215	3-9	17	9-9	4-4	15-9	70	39	6 548	6 559	6 359	3-9	18	9-9	4-5	15-9	73
40	6 400	6 411	6 218	4-0	18	10-0	4-4	16-0	71	40	6 550	6 561	6 361	4-0	18	10-0	4-6	16-0	73
41	6 403	6 413	6 220	4-1	18	10-1	4-5	16-1	71	41	6 553	6 564	6 363	4-1	19	10-1	4-6	16-1	74
42	6 405	6 416	6 223	4-2	19	10-2	4-5	16-2	72	42	6 555	6 566	6 366	4-2	19	10-2	4-7	16-2	74
43	6 408	6 418	6 225	4-3	19	10-3	4-5	16-3	72	43	6 558	6 569	6 368	4-3	20	10-3	4-7	16-3	75
44	6 410	6 421	6 227	4-4	19	10-4	4-6	16-4	72	44	6 560	6 571	6 370	4-4	20	10-4	4-8	16-4	75
45	6 413	6 423	6 230	4-5	20	10-5	4-6	16-5	73	45	6 563	6 574	6 373	4-5	21	10-5	4-8	16-5	76
46	6 415	6 426	6 232	4-6	20	10-6	4-7	16-6	73	46	6 565	6 576	6 375	4-6	21	10-6	4-9	16-6	76
47	6 418	6 428	6 234	4-7	21	10-7	4-7	16-7	74	47	6 568	6 579	6 378	4-7	22	10-7	4-9	16-7	77
48	6 420	6 431	6 237	4-8	21	10-8	4-8	16-8	74	48	6 570	6 581	6 380	4-8	22	10-8	5-0	16-8	77
49	6 423	6 434	6 239	4-9	22	10-9	4-8	16-9	75	49	6 573	6 584	6 382	4-9	22	10-9	5-0	16-9	77
50	6 425	6 436	6 242	5-0	22	11-0	4-9	17-0	75	50	6 575	6 586	6 385	5-0	23	11-0	5-0	17-0	78
51	6 428	6 439	6 244	5-1	23	11-1	4-9	17-1	76	51	6 578	6 589	6 387	5-1	23	11-1	5-1	17-1	78
52	6 430	6 441	6 246	5-2	23	11-2	4-9	17-2	76	52	6 580	6 591	6 390	5-2	24	11-2	5-1	17-2	79
53	6 433	6 444	6 249	5-3	23	11-3	5-0	17-3	76	53	6 583	6 594	6 392	5-3	24	11-3	5-2	17-3	79
54	6 435	6 446	6 251	5-4	24	11-4	5-0	17-4	77	54	6 585	6 596	6 394	5-4	25	11-4	5-2	17-4	80
55	6 438	6 449	6 254	5-5	24	11-5	5-1	17-5	77	55	6 588	6 599	6 397	5-5	25	11-5	5-3	17-5	80
56	6 440	6 451	6 256	5-6	25	11-6	5-1	17-6	78	56	6 590	7 001	6 399	5-6	26	11-6	5-3	17-6	81
57	6 443	6 454	6 258	5-7	25	11-7	5-2	17-7	78	57	6 593	7 004	6 402	5-7	26	11-7	5-4	17-7	81
58	6 445	6 456	6 261	5-8	26	11-8	5-2	17-8	79	58	6 595	7 006	6 404	5-8	27	11-8	5-4	17-8	82
59	6 448	6 459	6 263	5-9	26	11-9	5-3	17-9	79	59	6 598	7 009	6 406	5-9	27	11-9	5-5	17-9	82
60	6 450	6 461	6 266	6-0	27	12-0	5-3	18-0	80	60	7 000	7 011	6 409	6-0	28	12-0	5-5	18-0	83



42 <sup>m</sup>	SUN PLANETS	ARIES	MOON	v or Corr		v or Corr		v or Corr		43 <sup>m</sup>	SUN PLANETS	ARIES	MOON	v or Corr		v or Corr		v or Corr	
				d	'	d	'	d	'					d	'	d	'	d	'
00	10 300	10 317	10 013	0-0	0-0	6-0	4-3	12-0	8-5	00	10 450	10 468	10 156	0-0	0-0	6-0	4-4	12-0	8-7
01	10 303	10 320	10 015	0-1	0-1	6-1	4-3	12-1	8-6	01	10 453	10 470	10 159	0-1	0-1	6-1	4-4	12-1	8-8
02	10 305	10 322	10 018	0-2	0-1	6-2	4-4	12-2	8-6	02	10 455	10 473	10 161	0-2	0-1	6-2	4-5	12-2	8-8
03	10 308	10 325	10 020	0-3	0-2	6-3	4-5	12-3	8-7	03	10 458	10 475	10 163	0-3	0-2	6-3	4-6	12-3	8-9
04	10 310	10 327	10 023	0-4	0-3	6-4	4-5	12-4	8-8	04	10 460	10 478	10 166	0-4	0-3	6-4	4-6	12-4	9-0
05	10 313	10 330	10 025	0-5	0-4	6-5	4-6	12-5	8-9	05	10 463	10 480	10 168	0-5	0-4	6-5	4-7	12-5	9-1
06	10 315	10 332	10 027	0-6	0-4	6-6	4-7	12-6	8-9	06	10 465	10 483	10 170	0-6	0-4	6-6	4-8	12-6	9-1
07	10 318	10 335	10 030	0-7	0-5	6-7	4-7	12-7	9-0	07	10 468	10 485	10 173	0-7	0-5	6-7	4-9	12-7	9-2
08	10 320	10 337	10 032	0-8	0-6	6-8	4-8	12-8	9-1	08	10 470	10 488	10 175	0-8	0-6	6-8	4-9	12-8	9-3
09	10 323	10 340	10 034	0-9	0-6	6-9	4-9	12-9	9-1	09	10 473	10 490	10 178	0-9	0-7	6-9	5-0	12-9	9-4
10	10 325	10 342	10 037	1-0	0-7	7-0	5-0	13-0	9-2	10	10 475	10 493	10 180	1-0	0-7	7-0	5-1	13-0	9-4
11	10 328	10 345	10 039	1-1	0-8	7-1	5-0	13-1	9-3	11	10 478	10 495	10 182	1-1	0-8	7-1	5-1	13-1	9-5
12	10 330	10 347	10 042	1-2	0-9	7-2	5-1	13-2	9-4	12	10 480	10 498	10 185	1-2	0-9	7-2	5-2	13-2	9-6
13	10 333	10 350	10 044	1-3	0-9	7-3	5-2	13-3	9-4	13	10 483	10 500	10 187	1-3	0-9	7-3	5-3	13-3	9-6
14	10 335	10 352	10 046	1-4	1-0	7-4	5-2	13-4	9-5	14	10 485	10 503	10 190	1-4	1-0	7-4	5-4	13-4	9-7
15	10 338	10 355	10 049	1-5	1-1	7-5	5-3	13-5	9-6	15	10 488	10 505	10 192	1-5	1-1	7-5	5-4	13-5	9-8
16	10 340	10 357	10 051	1-6	1-1	7-6	5-4	13-6	9-6	16	10 490	10 508	10 194	1-6	1-2	7-6	5-5	13-6	9-9
17	10 343	10 360	10 054	1-7	1-2	7-7	5-5	13-7	9-7	17	10 493	10 510	10 197	1-7	1-2	7-7	5-6	13-7	9-9
18	10 345	10 362	10 056	1-8	1-3	7-8	5-5	13-8	9-8	18	10 495	10 513	10 199	1-8	1-3	7-8	5-7	13-8	10-0
19	10 348	10 365	10 058	1-9	1-3	7-9	5-6	13-9	9-8	19	10 498	10 515	10 202	1-9	1-4	7-9	5-7	13-9	10-1
20	10 350	10 367	10 061	2-0	1-4	8-0	5-7	14-0	9-9	20	10 500	10 518	10 204	2-0	1-5	8-0	5-8	14-0	10-2
21	10 353	10 370	10 063	2-1	1-5	8-1	5-7	14-1	10-0	21	10 503	10 520	10 206	2-1	1-5	8-1	5-9	14-1	10-2
22	10 355	10 372	10 065	2-2	1-6	8-2	5-8	14-2	10-1	22	10 505	10 523	10 209	2-2	1-6	8-2	5-9	14-2	10-3
23	10 358	10 375	10 068	2-3	1-6	8-3	5-9	14-3	10-1	23	10 508	10 525	10 211	2-3	1-7	8-3	6-0	14-3	10-4
24	10 360	10 377	10 070	2-4	1-7	8-4	6-0	14-4	10-2	24	10 510	10 528	10 213	2-4	1-7	8-4	6-1	14-4	10-4
25	10 363	10 380	10 073	2-5	1-8	8-5	6-0	14-5	10-3	25	10 513	10 530	10 216	2-5	1-8	8-5	6-2	14-5	10-5
26	10 365	10 382	10 075	2-6	1-8	8-6	6-1	14-6	10-3	26	10 515	10 533	10 218	2-6	1-9	8-6	6-2	14-6	10-6
27	10 368	10 385	10 077	2-7	1-9	8-7	6-2	14-7	10-4	27	10 518	10 535	10 221	2-7	2-0	8-7	6-3	14-7	10-7
28	10 370	10 387	10 080	2-8	2-0	8-8	6-2	14-8	10-5	28	10 520	10 538	10 223	2-8	2-0	8-8	6-4	14-8	10-7
29	10 373	10 390	10 082	2-9	2-1	8-9	6-3	14-9	10-6	29	10 523	10 540	10 225	2-9	2-1	8-9	6-5	14-9	10-8
30	10 375	10 392	10 085	3-0	2-1	9-0	6-4	15-0	10-6	30	10 525	10 543	10 228	3-0	2-2	9-0	6-5	15-0	10-9
31	10 378	10 395	10 087	3-1	2-2	9-1	6-4	15-1	10-7	31	10 528	10 545	10 230	3-1	2-2	9-1	6-6	15-1	10-9
32	10 380	10 397	10 089	3-2	2-3	9-2	6-5	15-2	10-8	32	10 530	10 548	10 233	3-2	2-3	9-2	6-7	15-2	11-0
33	10 383	10 400	10 092	3-3	2-3	9-3	6-6	15-3	10-8	33	10 533	10 550	10 235	3-3	2-4	9-3	6-7	15-3	11-1
34	10 385	10 402	10 094	3-4	2-4	9-4	6-7	15-4	10-9	34	10 535	10 553	10 237	3-4	2-5	9-4	6-8	15-4	11-2
35	10 388	10 405	10 097	3-5	2-5	9-5	6-7	15-5	11-0	35	10 538	10 555	10 240	3-5	2-5	9-5	6-9	15-5	11-2
36	10 390	10 407	10 099	3-6	2-6	9-6	6-8	15-6	11-1	36	10 540	10 558	10 242	3-6	2-6	9-6	7-0	15-6	11-3
37	10 393	10 410	10 101	3-7	2-6	9-7	6-9	15-7	11-1	37	10 543	10 560	10 244	3-7	2-7	9-7	7-0	15-7	11-4
38	10 395	10 413	10 104	3-8	2-7	9-8	6-9	15-8	11-2	38	10 545	10 563	10 247	3-8	2-8	9-8	7-1	15-8	11-5
39	10 398	10 415	10 106	3-9	2-8	9-9	7-0	15-9	11-3	39	10 548	10 565	10 249	3-9	2-8	9-9	7-2	15-9	11-5
40	10 400	10 418	10 108	4-0	2-8	10-0	7-1	16-0	11-3	40	10 550	10 568	10 252	4-0	2-9	10-0	7-3	16-0	11-6
41	10 403	10 420	10 111	4-1	2-9	10-1	7-2	16-1	11-4	41	10 553	10 570	10 254	4-1	3-0	10-1	7-3	16-1	11-7
42	10 405	10 423	10 113	4-2	3-0	10-2	7-2	16-2	11-5	42	10 555	10 573	10 256	4-2	3-0	10-2	7-4	16-2	11-7
43	10 408	10 425	10 116	4-3	3-0	10-3	7-3	16-3	11-5	43	10 558	10 575	10 259	4-3	3-1	10-3	7-5	16-3	11-8
44	10 410	10 428	10 118	4-4	3-1	10-4	7-4	16-4	11-6	44	10 560	10 578	10 261	4-4	3-2	10-4	7-5	16-4	11-9
45	10 413	10 430	10 120	4-5	3-2	10-5	7-4	16-5	11-7	45	10 563	10 580	10 264	4-5	3-3	10-5	7-6	16-5	12-0
46	10 415	10 433	10 123	4-6	3-3	10-6	7-5	16-6	11-8	46	10 565	10 583	10 266	4-6	3-3	10-6	7-7	16-6	12-0
47	10 418	10 435	10 125	4-7	3-3	10-7	7-6	16-7	11-8	47	10 568	10 585	10 268	4-7	3-4	10-7	7-8	16-7	12-1
48	10 420	10 438	10 128	4-8	3-4	10-8	7-7	16-8	11-9	48	10 570	10 588	10 271	4-8	3-5	10-8	7-8	16-8	12-2
49	10 423	10 440	10 130	4-9	3-5	10-9	7-7	16-9	12-0	49	10 573	10 590	10 273	4-9	3-6	10-9	7-9	16-9	12-3
50	10 425	10 443	10 132	5-0	3-5	11-0	7-8	17-0	12-0	50	10 575	10 593	10 275	5-0	3-6	11-0	8-0	17-0	12-3
51	10 428	10 445	10 135	5-1	3-6	11-1	7-9	17-1	12-1	51	10 578	10 596	10 278	5-1	3-7	11-1	8-0	17-1	12-4
52	10 430	10 448	10 137	5-2	3-7	11-2	7-9	17-2	12-2	52	10 580	10 598	10 280	5-2	3-8	11-2	8-1	17-2	12-5
53	10 433	10 450	10 139	5-3	3-8	11-3	8-0	17-3	12-3	53	10 583	11 001	10 283	5-3	3-8	11-3	8-2	17-3	12-5
54	10 435	10 453	10 142	5-4	3-8	11-4	8-1	17-4	12-3	54	10 585	11 003	10 285	5-4	3-9	11-4	8-3	17-4	12-6
55	10 438	10 455	10 144	5-5	3-9	11-5	8-1	17-5	12-4	55	10 588	11 006	10 287	5-5	4-0	11-5	8-3	17-5	12-7
56	10 440	10 458	10 147	5-6	4-0	11-6	8-2	17-6	12-5	56	10 590	11 008	10 290	5-6	4-1	11-6	8-4	17-6	12-8
57	10 443	10 460	10 149	5-7	4-0	11-7	8-3	17-7	12-5	57	10 593	11 011	10 292	5-7	4-1	11-7	8-5	17-7	12-8
58	10 445	10 463	10 151	5-8	4-1	11-8	8-4	17-8	12-6	58	10 595	11 013	10 295	5-8	4-2	11-8	8-6	17-8	12-9
59	10 448	10 465	10 154	5-9	4-2	11-9	8-4	17-9	12-7	59	10 598	11 016	10 297	5-9	4-3	11-9	8-6	17-9	13-0
60	10 450	10 468	10 156	6-0	4-3	12-0	8-5	18-0	12-8	60	11 000	11 018	10 299	6-0	4-4	12-0	8-7	18-0	13-1

n 44	SUN PLANETS	ARIES	MOON	° of Corr <sup>n</sup>			n 45	SUN PLANETS	ARIES	MOON	° of Corr <sup>n</sup>								
				d	'	"					d	'	"						
00	11 00-0	11 01-8	10 29-9	0-0	0-0	6-0	4-5	12-0	8-9	00	11 15-0	11 16-8	10 44-3	0-0	0-0	6-0	4-6	12-0	9-1
01	11 00-3	11 02-1	10 30-2	0-1	0-1	6-1	4-5	12-1	9-0	01	11 15-3	11 17-1	10 44-5	0-1	0-1	6-1	4-6	12-1	9-2
02	11 00-5	11 02-3	10 30-4	0-2	0-1	6-2	4-6	12-2	9-0	02	11 15-5	11 17-3	10 44-7	0-2	0-2	6-2	4-7	12-2	9-3
03	11 00-8	11 02-6	10 30-6	0-3	0-2	6-3	4-7	12-3	9-1	03	11 15-8	11 17-6	10 45-0	0-3	0-2	6-3	4-8	12-3	9-3
04	11 01-0	11 02-8	10 30-9	0-4	0-3	6-4	4-7	12-4	9-2	04	11 16-0	11 17-9	10 45-2	0-4	0-3	6-4	4-9	12-4	9-4
05	11 01-3	11 03-1	10 31-1	0-5	0-4	6-5	4-8	12-5	9-3	05	11 16-3	11 18-1	10 45-4	0-5	0-4	6-5	4-9	12-5	9-5
06	11 01-5	11 03-3	10 31-4	0-6	0-4	6-6	4-9	12-6	9-3	06	11 16-5	11 18-4	10 45-7	0-6	0-5	6-6	5-0	12-6	9-6
07	11 01-8	11 03-6	10 31-6	0-7	0-5	6-7	5-0	12-7	9-4	07	11 16-8	11 18-6	10 45-9	0-7	0-5	6-7	5-1	12-7	9-6
08	11 02-0	11 03-8	10 31-8	0-8	0-6	6-8	5-0	12-8	9-5	08	11 17-0	11 18-9	10 46-2	0-8	0-6	6-8	5-2	12-8	9-7
09	11 02-3	11 04-1	10 32-1	0-9	0-7	6-9	5-1	12-9	9-6	09	11 17-3	11 19-1	10 46-4	0-9	0-7	6-9	5-2	12-9	9-8
10	11 02-5	11 04-3	10 32-3	1-0	0-7	7-0	5-2	13-0	9-6	10	11 17-5	11 19-4	10 46-6	1-0	0-8	7-0	5-3	13-0	9-9
11	11 02-8	11 04-6	10 32-6	1-1	0-8	7-1	5-3	13-1	9-7	11	11 17-8	11 19-6	10 46-9	1-1	0-8	7-1	5-4	13-1	9-9
12	11 03-0	11 04-8	10 32-8	1-2	0-9	7-2	5-3	13-2	9-8	12	11 18-0	11 19-9	10 47-1	1-2	0-9	7-2	5-5	13-2	10-0
13	11 03-3	11 05-1	10 33-0	1-3	1-0	7-3	5-4	13-3	9-9	13	11 18-3	11 20-1	10 47-4	1-3	1-0	7-3	5-5	13-3	10-1
14	11 03-5	11 05-3	10 33-3	1-4	1-0	7-4	5-5	13-4	9-9	14	11 18-5	11 20-4	10 47-6	1-4	1-1	7-4	5-6	13-4	10-2
15	11 03-8	11 05-6	10 33-5	1-5	1-1	7-5	5-6	13-5	10-0	15	11 18-8	11 20-6	10 47-8	1-5	1-1	7-5	5-7	13-5	10-2
16	11 04-0	11 05-8	10 33-8	1-6	1-2	7-6	5-6	13-6	10-1	16	11 19-0	11 20-9	10 48-1	1-6	1-2	7-6	5-8	13-6	10-3
17	11 04-3	11 06-1	10 34-0	1-7	1-3	7-7	5-7	13-7	10-2	17	11 19-3	11 21-1	10 48-3	1-7	1-3	7-7	5-8	13-7	10-4
18	11 04-5	11 06-3	10 34-2	1-8	1-3	7-8	5-8	13-8	10-2	18	11 19-5	11 21-4	10 48-5	1-8	1-4	7-8	5-9	13-8	10-5
19	11 04-8	11 06-6	10 34-5	1-9	1-4	7-9	5-9	13-9	10-3	19	11 19-8	11 21-6	10 48-8	1-9	1-4	7-9	6-0	13-9	10-5
20	11 05-0	11 06-8	10 34-7	2-0	1-5	8-0	5-9	14-0	10-4	20	11 20-0	11 21-9	10 49-0	2-0	1-5	8-0	6-1	14-0	10-6
21	11 05-3	11 07-1	10 34-9	2-1	1-6	8-1	6-0	14-1	10-5	21	11 20-3	11 22-1	10 49-3	2-1	1-6	8-1	6-1	14-1	10-7
22	11 05-5	11 07-3	10 35-2	2-2	1-6	8-2	6-1	14-2	10-5	22	11 20-5	11 22-4	10 49-5	2-2	1-7	8-2	6-2	14-2	10-8
23	11 05-8	11 07-6	10 35-4	2-3	1-7	8-3	6-2	14-3	10-6	23	11 20-8	11 22-6	10 49-7	2-3	1-7	8-3	6-3	14-3	10-8
24	11 06-0	11 07-8	10 35-7	2-4	1-8	8-4	6-2	14-4	10-7	24	11 21-0	11 22-9	10 50-0	2-4	1-8	8-4	6-4	14-4	10-9
25	11 06-3	11 08-1	10 35-9	2-5	1-9	8-5	6-3	14-5	10-8	25	11 21-3	11 23-1	10 50-2	2-5	1-9	8-5	6-4	14-5	11-0
26	11 06-5	11 08-3	10 36-1	2-6	1-9	8-6	6-4	14-6	10-8	26	11 21-5	11 23-4	10 50-5	2-6	2-0	8-6	6-5	14-6	11-1
27	11 06-8	11 08-6	10 36-4	2-7	2-0	8-7	6-5	14-7	10-9	27	11 21-8	11 23-6	10 50-7	2-7	2-0	8-7	6-6	14-7	11-1
28	11 07-0	11 08-8	10 36-6	2-8	2-1	8-8	6-5	14-8	11-0	28	11 22-0	11 23-9	10 50-9	2-8	2-1	8-8	6-7	14-8	11-2
29	11 07-3	11 09-1	10 36-9	2-9	2-2	8-9	6-6	14-9	11-1	29	11 22-3	11 24-1	10 51-2	2-9	2-2	8-9	6-7	14-9	11-3
30	11 07-5	11 09-3	10 37-1	3-0	2-2	9-0	6-7	15-0	11-1	30	11 22-5	11 24-4	10 51-4	3-0	2-3	9-0	6-8	15-0	11-4
31	11 07-8	11 09-6	10 37-3	3-1	2-3	9-1	6-7	15-1	11-2	31	11 22-8	11 24-6	10 51-6	3-1	2-4	9-1	6-9	15-1	11-5
32	11 08-0	11 09-8	10 37-6	3-2	2-4	9-2	6-8	15-2	11-3	32	11 23-0	11 24-9	10 51-9	3-2	2-4	9-2	7-0	15-2	11-5
33	11 08-3	11 10-1	10 37-8	3-3	2-4	9-3	6-9	15-3	11-3	33	11 23-3	11 25-1	10 52-1	3-3	2-5	9-3	7-1	15-3	11-6
34	11 08-5	11 10-3	10 38-0	3-4	2-5	9-4	7-0	15-4	11-4	34	11 23-5	11 25-4	10 52-4	3-4	2-6	9-4	7-1	15-4	11-7
35	11 08-8	11 10-6	10 38-3	3-5	2-6	9-5	7-0	15-5	11-5	35	11 23-8	11 25-6	10 52-6	3-5	2-7	9-5	7-2	15-5	11-8
36	11 09-0	11 10-8	10 38-5	3-6	2-7	9-6	7-1	15-6	11-6	36	11 24-0	11 25-9	10 52-8	3-6	2-7	9-6	7-3	15-6	11-8
37	11 09-3	11 11-1	10 38-8	3-7	2-7	9-7	7-2	15-7	11-6	37	11 24-3	11 26-1	10 53-1	3-7	2-8	9-7	7-4	15-7	11-9
38	11 09-5	11 11-3	10 39-0	3-8	2-8	9-8	7-3	15-8	11-7	38	11 24-5	11 26-4	10 53-3	3-8	2-9	9-8	7-4	15-8	12-0
39	11 09-8	11 11-6	10 39-2	3-9	2-9	9-9	7-3	15-9	11-8	39	11 24-8	11 26-6	10 53-6	3-9	3-0	9-9	7-5	15-9	12-1
40	11 10-0	11 11-8	10 39-5	4-0	3-0	10-0	7-4	16-0	11-9	40	11 25-0	11 26-9	10 53-8	4-0	3-0	10-0	7-6	16-0	12-1
41	11 10-3	11 12-1	10 39-7	4-1	3-0	10-1	7-5	16-1	11-9	41	11 25-3	11 27-1	10 54-0	4-1	3-1	10-1	7-7	16-1	12-2
42	11 10-5	11 12-3	10 40-0	4-2	3-1	10-2	7-6	16-2	12-0	42	11 25-5	11 27-4	10 54-3	4-2	3-2	10-2	7-7	16-2	12-3
43	11 10-8	11 12-6	10 40-2	4-3	3-2	10-3	7-6	16-3	12-1	43	11 25-8	11 27-6	10 54-5	4-3	3-3	10-3	7-8	16-3	12-4
44	11 11-0	11 12-8	10 40-4	4-4	3-3	10-4	7-7	16-4	12-2	44	11 26-0	11 27-9	10 54-7	4-4	3-3	10-4	7-9	16-4	12-4
45	11 11-3	11 13-1	10 40-7	4-5	3-3	10-5	7-8	16-5	12-2	45	11 26-3	11 28-1	10 55-0	4-5	3-4	10-5	8-0	16-5	12-5
46	11 11-5	11 13-3	10 40-9	4-6	3-4	10-6	7-9	16-6	12-3	46	11 26-5	11 28-4	10 55-2	4-6	3-5	10-6	8-0	16-6	12-6
47	11 11-8	11 13-6	10 41-1	4-7	3-5	10-7	7-9	16-7	12-4	47	11 26-8	11 28-6	10 55-5	4-7	3-6	10-7	8-1	16-7	12-7
48	11 12-0	11 13-8	10 41-4	4-8	3-6	10-8	8-0	16-8	12-5	48	11 27-0	11 28-9	10 55-7	4-8	3-6	10-8	8-2	16-8	12-7
49	11 12-3	11 14-1	10 41-6	4-9	3-6	10-9	8-1	16-9	12-5	49	11 27-3	11 29-1	10 55-9	4-9	3-7	10-9	8-3	16-9	12-8
50	11 12-5	11 14-3	10 41-9	5-0	3-7	11-0	8-2	17-0	12-6	50	11 27-5	11 29-4	10 56-2	5-0	3-8	11-0	8-3	17-0	12-9
51	11 12-8	11 14-6	10 42-1	5-1	3-8	11-1	8-2	17-1	12-7	51	11 27-8	11 29-6	10 56-4	5-1	3-9	11-1	8-4	17-1	13-0
52	11 13-0	11 14-8	10 42-3	5-2	3-9	11-2	8-3	17-2	12-8	52	11 28-0	11 29-9	10 56-7	5-2	3-9	11-2	8-5	17-2	13-0
53	11 13-3	11 15-1	10 42-6	5-3	3-9	11-3	8-4	17-3	12-8	53	11 28-3	11 30-1	10 56-9	5-3	4-0	11-3	8-6	17-3	13-1
54	11 13-5	11 15-3	10 42-8	5-4	4-0	11-4	8-5	17-4	12-9	54	11 28-5	11 30-4	10 57-1	5-4	4-1	11-4	8-6	17-4	13-2
55	11 13-8	11 15-6	10 43-1	5-5	4-1	11-5	8-5	17-5	13-0	55	11 28-8	11 30-6	10 57-4	5-5	4-2	11-5	8-7	17-5	13-3
56	11 14-0	11 15-8	10 43-3	5-6	4-2	11-6	8-6	17-6	13-1	56	11 29-0	11 30-9	10 57-6	5-6	4-2	11-6	8-8	17-6	13-3
57	11 14-3	11 16-1	10 43-5	5-7	4-2	11-7	8-7	17-7	13-1	57	11 29-3	11 31-1	10 57-9	5-7	4-3	11-7	8-9	17-7	13-4
58	11 14-5	11 16-3	10 43-8	5-8	4-3	11-8	8-8	17-8	13-2	58	11 29-5	11 31-4	10 58-1	5-8	4-4	11-8	8-9	17-8	13-5
59	11 14-8	11 16-6	10 44-0	5-9	4-4	11-9	8-8	17-9	13-3	59	11 29-8	11 31-6	10 58-3	5-9	4-5	11-9	9-0	17-9	13-6
60	11 15-0	11 16-8	10 44-3	6-0	4-5	12-0	8-9	18-0	13-4	60	11 30-0	11 31-9	10 58-6	6-0	4-6	12-0	9-1	18-0	13-7

56 <sup>m</sup>	SUN PLANETS			ARIES	MOON	v or Corr <sup>n</sup>			57 <sup>m</sup>	SUN PLANETS			ARIES	MOON	v or Corr <sup>n</sup>				
	d	'	"			d	'	"		d	'	"			d	'	"	d	'
00	14 00-0	14 02-3	13 21-7	0-0	0-0	6-0	5-7	12-0	11-3	00	14 15-0	14 17-3	13 36-1	0-0	0-0	6-0	5-8	12-0	11-5
01	14 00-3	14 02-6	13 22-0	0-1	0-1	6-1	5-7	12-1	11-4	01	14 15-3	14 17-6	13 36-3	0-1	0-1	6-1	5-8	12-1	11-6
02	14 00-5	14 02-8	13 22-2	0-2	0-2	6-2	5-8	12-2	11-5	02	14 15-5	14 17-8	13 36-5	0-2	0-2	6-2	5-9	12-2	11-7
03	14 00-8	14 03-1	13 22-4	0-3	0-3	6-3	5-9	12-3	11-6	03	14 15-8	14 18-1	13 36-8	0-3	0-3	6-3	6-0	12-3	11-8
04	14 01-0	14 03-3	13 22-7	0-4	0-4	6-4	6-0	12-4	11-7	04	14 16-0	14 18-3	13 37-0	0-4	0-4	6-4	6-1	12-4	11-9
05	14 01-3	14 03-6	13 22-9	0-5	0-5	6-5	6-1	12-5	11-8	05	14 16-3	14 18-6	13 37-2	0-5	0-5	6-5	6-2	12-5	12-0
06	14 01-5	14 03-8	13 23-2	0-6	0-6	6-6	6-2	12-6	11-9	06	14 16-5	14 18-8	13 37-5	0-6	0-6	6-6	6-3	12-6	12-1
07	14 01-8	14 04-1	13 23-4	0-7	0-7	6-7	6-3	12-7	12-0	07	14 16-8	14 19-1	13 37-7	0-7	0-7	6-7	6-4	12-7	12-2
08	14 02-0	14 04-3	13 23-6	0-8	0-8	6-8	6-4	12-8	12-1	08	14 17-0	14 19-3	13 38-0	0-8	0-8	6-8	6-5	12-8	12-3
09	14 02-3	14 04-6	13 23-9	0-9	0-8	6-9	6-5	12-9	12-1	09	14 17-3	14 19-6	13 38-2	0-9	0-9	6-9	6-6	12-9	12-4
10	14 02-5	14 04-8	13 24-1	1-0	0-9	7-0	6-6	13-0	12-2	10	14 17-5	14 19-8	13 38-4	1-0	1-0	7-0	6-7	13-0	12-5
11	14 02-8	14 05-1	13 24-4	1-1	1-0	7-1	6-7	13-1	12-3	11	14 17-8	14 20-1	13 38-7	1-1	1-1	7-1	6-8	13-1	12-6
12	14 03-0	14 05-3	13 24-6	1-2	1-1	7-2	6-8	13-2	12-4	12	14 18-0	14 20-3	13 38-9	1-2	1-2	7-2	6-9	13-2	12-7
13	14 03-3	14 05-6	13 24-8	1-3	1-2	7-3	6-9	13-3	12-5	13	14 18-3	14 20-6	13 39-2	1-3	1-2	7-3	7-0	13-3	12-7
14	14 03-5	14 05-8	13 25-1	1-4	1-3	7-4	7-0	13-4	12-6	14	14 18-5	14 20-9	13 39-4	1-4	1-3	7-4	7-1	13-4	12-8
15	14 03-8	14 06-1	13 25-3	1-5	1-4	7-5	7-1	13-5	12-7	15	14 18-8	14 21-1	13 39-6	1-5	1-4	7-5	7-2	13-5	12-9
16	14 04-0	14 06-3	13 25-6	1-6	1-5	7-6	7-2	13-6	12-8	16	14 19-0	14 21-4	13 39-9	1-6	1-5	7-6	7-3	13-6	13-0
17	14 04-3	14 06-6	13 25-8	1-7	1-6	7-7	7-3	13-7	12-9	17	14 19-3	14 21-6	13 40-1	1-7	1-6	7-7	7-4	13-7	13-1
18	14 04-5	14 06-8	13 26-0	1-8	1-7	7-8	7-3	13-8	13-0	18	14 19-5	14 21-9	13 40-3	1-8	1-7	7-8	7-5	13-8	13-2
19	14 04-8	14 07-1	13 26-3	1-9	1-8	7-9	7-4	13-9	13-1	19	14 19-8	14 22-1	13 40-6	1-9	1-8	7-9	7-6	13-9	13-3
20	14 05-0	14 07-3	13 26-5	2-0	1-9	8-0	7-5	14-0	13-2	20	14 20-0	14 22-4	13 40-8	2-0	1-9	8-0	7-7	14-0	13-4
21	14 05-3	14 07-6	13 26-7	2-1	2-0	8-1	7-6	14-1	13-3	21	14 20-3	14 22-6	13 41-1	2-1	2-0	8-1	7-8	14-1	13-5
22	14 05-5	14 07-8	13 27-0	2-2	2-1	8-2	7-7	14-2	13-4	22	14 20-5	14 22-9	13 41-3	2-2	2-1	8-2	7-9	14-2	13-6
23	14 05-8	14 08-1	13 27-2	2-3	2-2	8-3	7-8	14-3	13-5	23	14 20-8	14 23-1	13 41-5	2-3	2-2	8-3	8-0	14-3	13-7
24	14 06-0	14 08-3	13 27-5	2-4	2-3	8-4	7-9	14-4	13-6	24	14 21-0	14 23-4	13 41-8	2-4	2-3	8-4	8-1	14-4	13-8
25	14 06-3	14 08-6	13 27-7	2-5	2-4	8-5	8-0	14-5	13-7	25	14 21-3	14 23-6	13 42-0	2-5	2-4	8-5	8-1	14-5	13-9
26	14 06-5	14 08-8	13 27-9	2-6	2-4	8-6	8-1	14-6	13-7	26	14 21-5	14 23-9	13 42-3	2-6	2-5	8-6	8-2	14-6	14-0
27	14 06-8	14 09-1	13 28-2	2-7	2-5	8-7	8-2	14-7	13-8	27	14 21-8	14 24-1	13 42-5	2-7	2-6	8-7	8-3	14-7	14-1
28	14 07-0	14 09-3	13 28-4	2-8	2-6	8-8	8-3	14-8	13-9	28	14 22-0	14 24-4	13 42-7	2-8	2-7	8-8	8-4	14-8	14-2
29	14 07-3	14 09-6	13 28-7	2-9	2-7	8-9	8-4	14-9	14-0	29	14 22-3	14 24-6	13 43-0	2-9	2-8	8-9	8-5	14-9	14-3
30	14 07-5	14 09-8	13 28-9	3-0	2-8	9-0	8-5	15-0	14-1	30	14 22-5	14 24-9	13 43-2	3-0	2-9	9-0	8-6	15-0	14-4
31	14 07-8	14 10-1	13 29-1	3-1	2-9	9-1	8-6	15-1	14-2	31	14 22-8	14 25-1	13 43-4	3-1	3-0	9-1	8-7	15-1	14-5
32	14 08-0	14 10-3	13 29-4	3-2	3-0	9-2	8-7	15-2	14-3	32	14 23-0	14 25-4	13 43-7	3-2	3-1	9-2	8-8	15-2	14-6
33	14 08-3	14 10-6	13 29-6	3-3	3-1	9-3	8-8	15-3	14-4	33	14 23-3	14 25-6	13 43-9	3-3	3-2	9-3	8-9	15-3	14-7
34	14 08-5	14 10-8	13 29-8	3-4	3-2	9-4	8-9	15-4	14-5	34	14 23-5	14 25-9	13 44-2	3-4	3-3	9-4	9-0	15-4	14-8
35	14 08-8	14 11-1	13 30-1	3-5	3-3	9-5	8-9	15-5	14-6	35	14 23-8	14 26-1	13 44-4	3-5	3-4	9-5	9-1	15-5	14-9
36	14 09-0	14 11-3	13 30-3	3-6	3-4	9-6	9-0	15-6	14-7	36	14 24-0	14 26-4	13 44-6	3-6	3-5	9-6	9-2	15-6	15-0
37	14 09-3	14 11-6	13 30-6	3-7	3-5	9-7	9-1	15-7	14-8	37	14 24-3	14 26-6	13 44-9	3-7	3-5	9-7	9-3	15-7	15-0
38	14 09-5	14 11-8	13 30-8	3-8	3-6	9-8	9-2	15-8	14-9	38	14 24-5	14 26-9	13 45-1	3-8	3-6	9-8	9-4	15-8	15-1
39	14 09-8	14 12-1	13 31-0	3-9	3-7	9-9	9-3	15-9	15-0	39	14 24-8	14 27-1	13 45-4	3-9	3-7	9-9	9-5	15-9	15-2
40	14 10-0	14 12-3	13 31-3	4-0	3-8	10-0	9-4	16-0	15-1	40	14 25-0	14 27-4	13 45-6	4-0	3-8	10-0	9-6	16-0	15-3
41	14 10-3	14 12-6	13 31-5	4-1	3-9	10-1	9-5	16-1	15-2	41	14 25-3	14 27-6	13 45-8	4-1	3-9	10-1	9-7	16-1	15-4
42	14 10-5	14 12-8	13 31-8	4-2	4-0	10-2	9-6	16-2	15-3	42	14 25-5	14 27-9	13 46-1	4-2	4-0	10-2	9-8	16-2	15-5
43	14 10-8	14 13-1	13 32-0	4-3	4-0	10-3	9-7	16-3	15-3	43	14 25-8	14 28-1	13 46-3	4-3	4-1	10-3	9-9	16-3	15-6
44	14 11-0	14 13-3	13 32-2	4-4	4-1	10-4	9-8	16-4	15-4	44	14 26-0	14 28-4	13 46-5	4-4	4-2	10-4	10-0	16-4	15-7
45	14 11-3	14 13-6	13 32-5	4-5	4-2	10-5	9-9	16-5	15-5	45	14 26-3	14 28-6	13 46-8	4-5	4-3	10-5	10-1	16-5	15-8
46	14 11-5	14 13-8	13 32-7	4-6	4-3	10-6	10-0	16-6	15-6	46	14 26-5	14 28-9	13 47-0	4-6	4-4	10-6	10-2	16-6	15-9
47	14 11-8	14 14-1	13 32-9	4-7	4-4	10-7	10-1	16-7	15-7	47	14 26-8	14 29-1	13 47-3	4-7	4-5	10-7	10-3	16-7	16-0
48	14 12-0	14 14-3	13 33-2	4-8	4-5	10-8	10-2	16-8	15-8	48	14 27-0	14 29-4	13 47-5	4-8	4-6	10-8	10-4	16-8	16-1
49	14 12-3	14 14-6	13 33-4	4-9	4-6	10-9	10-3	16-9	15-9	49	14 27-3	14 29-6	13 47-7	4-9	4-7	10-9	10-4	16-9	16-2
50	14 12-5	14 14-8	13 33-7	5-0	4-7	11-0	10-4	17-0	16-0	50	14 27-5	14 29-9	13 48-0	5-0	4-8	11-0	10-5	17-0	16-3
51	14 12-8	14 15-1	13 33-9	5-1	4-8	11-1	10-5	17-1	16-1	51	14 27-8	14 30-1	13 48-2	5-1	4-9	11-1	10-6	17-1	16-4
52	14 13-0	14 15-3	13 34-1	5-2	4-9	11-2	10-5	17-2	16-2	52	14 28-0	14 30-4	13 48-5	5-2	5-0	11-2	10-7	17-2	16-5
53	14 13-3	14 15-6	13 34-4	5-3	5-0	11-3	10-6	17-3	16-3	53	14 28-3	14 30-6	13 48-7	5-3	5-1	11-3	10-8	17-3	16-6
54	14 13-5	14 15-8	13 34-6	5-4	5-1	11-4	10-7	17-4	16-4	54	14 28-5	14 30-9	13 48-9	5-4	5-2	11-4	10-9	17-4	16-7
55	14 13-8	14 16-1	13 34-9	5-5	5-2	11-5	10-8	17-5	16-5	55	14 28-8	14 31-1	13 49-2	5-5	5-3	11-5	11-0	17-5	16-8
56	14 14-0	14 16-3	13 35-1	5-6	5-3	11-6	10-9	17-6	16-6	56	14 29-0	14 31-4	13 49-4	5-6	5-4	11-6	11-1	17-6	16-9
57	14 14-3	14 16-6	13 35-3	5-7	5-4	11-7	11-0	17-7	16-7	57	14 29-3	14 31-6	13 49-7	5-7	5-5	11-7	11-2	17-7	17-0
58	14 14-5	14 16-8	13 35-6	5-8	5-5	11-8	11-1	17-8	16-8	58	14 29-5	14 31-9	13 49-9	5-8	5-6	11-8	11-3	17-8	17-1
59	14 14-8	14 17-1	13 35-8	5-9	5-6	11-9	11-2	17-9	16-9	59	14 29-8	14 32-1	13 50-1	5-9	5-7	11-9	11-4	17-9	17-2
60	14 15-0	14 17-3	13 36-1	6-0	5-7	12-0	11-3	18-0	17-0	60	14 30-0	14 32-4	13 50-4	6-0	5-8	12-0	11-5	18-0	17-3

PUB. NO. 229

VOL. 3

# SIGHT REDUCTION TABLES

FOR

## MARINE NAVIGATION

LATITUDES 30°-45°, Inclusive

PUBLISHED BY THE  
DEFENSE MAPPING AGENCY HYDROGRAPHIC CENTER



U.S. GOVERNMENT PRINTING OFFICE  
WASHINGTON : 1974

---

For sale by authorized Sales Agents of the Defense Mapping Agency Hydrographic Center

B-1













5°, 355° L.H.A.

LATITUDE SAME NAME AS DECLINATION

N. Lat. { L.H.A. greater than 180°.....Zn=Z  
L.H.A. less than 180°.....Zn=360°-Z

Table with columns for Dec. (0-90), 38°, 39°, 40°, 41°, 42°, 43°, 44°, 45°, and Dec. (0-90). Each column contains three sub-columns labeled Hc, d, and Z. The table provides astronomical data for various latitudes and declinations.

5°, 355° L.H.A.

LATITUDE SAME NAME AS DECLINATION



7°, 353° L.H.A.

LATITUDE SAME NAME AS DECLINATION

N. Lat. { L.H.A. greater than 180° ..... Zn=Z
L.H.A. less than 180° ..... Zn=360°-Z

Main table with columns for Dec. (0-90), 38°, 39°, 40°, 41°, 42°, 43°, 44°, 45°, and Dec. (0-90). Each degree column contains three sub-columns (Mc, d, Z) with numerical values.

7°, 353° L.H.A.

LATITUDE SAME NAME AS DECLINATION

LATITUDE CONTRARY NAME TO DECLINATION

L.H.A. 7°, 353°

Dec.	38°			39°			40°			41°			42°			43°			44°			45°			Dec.			
	Hc	d	Z	Hc	d	Z	Hc	d	Z	Hc	d	Z	Hc	d	Z	Hc	d	Z	Hc	d	Z	Hc	d	Z		Hc	d	Z
0	51 27.4	59.3	168.7	50 28.5	59.3	169.0	49 29.6	59.4	169.2	48 30.7	59.5	169.4	47 31.7	59.5	169.6	46 32.6	59.5	169.8	45 33.6	59.6	170.0	44 34.5	59.6	170.1	0	51 27.4	59.3	168.7
1	50 28.1	59.3	169.0	49 29.2	59.4	169.2	48 30.2	59.4	169.4	47 31.2	59.4	169.6	46 32.2	59.5	169.8	45 33.1	59.5	170.0	44 34.0	59.5	170.0	43 34.5	59.5	170.2	1	50 28.1	59.3	169.0
2	49 28.8	59.4	169.2	48 29.8	59.4	169.4	47 30.8	59.4	169.6	46 31.8	59.5	169.8	45 32.7	59.5	170.0	44 33.6	59.5	170.2	43 34.5	59.5	170.2	42 34.9	59.6	170.5	2	49 28.8	59.4	169.2
3	48 29.4	59.4	169.4	47 30.4	59.4	169.6	46 31.4	59.4	169.8	45 32.3	59.5	170.0	44 33.2	59.5	170.2	43 33.7	59.5	170.2	42 34.1	59.6	170.3	41 35.3	59.6	170.5	3	48 29.4	59.4	169.4
4	47 30.0	59.4	169.6	46 31.0	59.4	169.8	45 31.9	59.4	170.0	44 32.8	59.5	170.2	43 33.7	59.5	170.2	42 34.5	59.5	170.5	41 35.3	59.6	170.5	40 36.1	59.6	170.8	4	47 30.0	59.4	169.6
5	46 30.6	59.4	169.8	45 31.6	59.5	170.0	44 32.5	59.5	170.2	43 33.3	59.5	170.4	42 34.2	59.6	170.5	41 35.0	59.6	170.7	40 35.7	59.6	170.7	39 36.5	59.6	170.9	5	46 30.6	59.4	169.8
6	45 31.2	59.4	170.0	44 32.1	59.5	170.2	43 33.0	59.5	170.4	42 33.8	59.5	170.5	41 34.6	59.6	170.7	40 35.4	59.6	170.8	39 36.1	59.6	170.8	38 36.9	59.6	171.1	6	45 31.2	59.4	170.0
7	44 31.8	59.5	170.2	43 32.6	59.5	170.4	42 33.5	59.6	170.5	41 34.3	59.6	170.7	40 35.0	59.6	170.8	39 35.8	59.6	171.0	38 36.5	59.6	171.0	37 37.2	59.6	171.2	7	44 31.8	59.5	170.2
8	43 32.3	59.5	170.4	42 33.1	59.5	170.6	41 33.9	59.5	170.7	40 34.7	59.6	170.9	39 35.5	59.6	171.0	38 36.2	59.6	171.1	37 36.9	59.6	171.1	36 37.6	59.6	171.4	8	43 32.3	59.5	170.4
9	42 32.8	59.5	170.6	41 33.6	59.5	170.7	40 34.4	59.6	170.9	39 35.1	59.6	171.0	38 35.9	59.6	171.1	37 36.6	59.6	171.3	36 37.3	59.6	171.4	35 37.9	59.6	171.5	9	42 32.8	59.5	170.6
10	41 33.3	59.5	170.8	40 34.1	59.5	170.9	39 34.8	59.5	171.0	38 35.6	59.6	171.2	37 36.3	59.6	171.3	36 36.9	59.6	171.4	35 37.6	59.6	171.5	34 38.3	59.6	171.6	10	41 33.3	59.5	170.8
11	40 33.8	59.5	171.0	39 34.6	59.6	171.1	38 35.3	59.6	171.2	37 36.0	59.6	171.3	36 36.7	59.6	171.4	35 37.3	59.6	171.5	34 38.0	59.6	171.5	33 38.6	59.6	171.7	11	40 33.8	59.5	171.0
12	39 34.3	59.5	171.1	38 35.0	59.6	171.2	37 35.7	59.6	171.3	36 36.4	59.6	171.4	35 37.0	59.6	171.5	34 37.7	59.6	171.7	33 38.3	59.6	171.7	32 38.9	59.6	171.9	12	39 34.3	59.5	171.1
13	38 34.8	59.6	171.3	37 35.4	59.6	171.4	36 36.1	59.6	171.5	35 36.8	59.6	171.6	34 37.4	59.6	171.7	33 38.0	59.6	171.8	32 38.6	59.6	171.9	31 39.2	59.6	172.0	13	38 34.8	59.6	171.3
14	37 35.2	59.6	171.4	36 35.9	59.6	171.5	35 36.5	59.6	171.6	34 37.1	59.6	171.7	33 37.8	59.6	171.8	32 38.4	59.6	171.9	31 39.0	59.6	172.0	30 39.5	59.6	172.1	14	37 35.2	59.6	171.4
15	36 35.6	59.5	171.6	35 36.3	59.6	171.7	34 36.9	59.6	171.8	33 37.5	59.6	171.9	32 38.1	59.6	172.0	31 38.7	59.6	172.1	30 39.3	59.6	172.1	29 39.8	59.6	172.2	15	36 35.6	59.5	171.6
16	35 36.1	59.6	171.7	34 36.7	59.6	171.8	33 37.3	59.6	171.9	32 37.9	59.6	172.0	31 38.5	59.6	172.1	30 39.0	59.6	172.2	29 39.6	59.6	172.2	28 40.1	59.6	172.3	16	35 36.1	59.6	171.7
17	34 36.5	59.6	171.9	33 37.1	59.6	172.0	32 37.7	59.6	172.0	31 38.2	59.6	172.1	30 38.8	59.6	172.2	29 39.3	59.6	172.3	28 39.9	59.6	172.3	27 40.4	59.6	172.4	17	34 36.5	59.6	171.9
18	33 36.9	59.6	172.0	32 37.5	59.6	172.1	31 38.0	59.6	172.2	30 38.6	59.6	172.2	29 39.1	59.6	172.3	28 39.7	59.6	172.4	27 40.2	59.6	172.4	26 40.5	59.6	172.5	18	33 36.9	59.6	172.0
19	32 37.3	59.6	172.1	31 37.8	59.6	172.2	30 38.4	59.6	172.3	29 38.9	59.6	172.3	28 39.4	59.6	172.5	27 40.0	59.6	172.5	26 40.5	59.6	172.5	25 41.0	59.6	172.6	19	32 37.3	59.6	172.1
20	31 37.7	59.6	172.3	30 38.2	59.6	172.4	29 38.7	59.6	172.4	28 39.3	59.6	172.4	27 39.8	59.6	172.6	26 40.3	59.6	172.6	25 40.8	59.6	172.6	24 41.2	59.6	172.8	20	31 37.7	59.6	172.3
21	30 38.0	59.6	172.4	29 38.6	59.6	172.5	28 39.1	59.6	172.6	27 39.6	59.6	172.6	26 40.1	59.6	172.7	25 40.6	59.6	172.7	24 41.0	59.6	172.8	23 41.5	59.6	172.9	21	30 38.0	59.6	172.4
22	29 38.4	59.6	172.5	28 38.9	59.6	172.6	27 39.4	59.6	172.7	26 39.9	59.6	172.7	25 40.4	59.6	172.8	24 40.9	59.6	172.9	23 41.3	59.6	172.9	22 41.8	59.6	173.0	22	29 38.4	59.6	172.5
23	28 38.8	59.6	172.7	27 39.3	59.6	172.7	26 39.8	59.6	172.8	25 40.2	59.6	172.9	24 40.7	59.6	172.9	23 41.1	59.6	173.0	22 41.6	59.6	173.0	21 42.0	59.6	173.1	23	28 38.8	59.6	172.7
24	27 39.1	59.6	172.8	26 39.6	59.6	172.8	25 40.1	59.6	172.9	24 40.5	59.6	173.0	23 41.0	59.6	173.0	22 41.4	59.6	173.1	21 41.9	59.6	173.1	20 42.3	59.6	173.2	24	27 39.1	59.6	172.8
25	26 39.5	59.6	172.9	25 39.9	59.6	173.0	24 40.4	59.6	173.0	23 40.8	59.6	173.1	22 41.3	59.6	173.1	21 41.7	59.6	173.2	20 42.1	59.6	173.2	19 42.5	59.6	173.3	25	26 39.5	59.6	172.9
26	25 39.8	59.6	173.0	24 40.3	59.6	173.1	23 40.7	59.6	173.1	22 41.1	59.6	173.2	21 41.5	59.6	173.2	20 41.9	59.6	173.3	19 42.4	59.6	173.3	18 42.8	59.6	173.4	26	25 39.8	59.6	173.0
27	24 40.2	59.6	173.1	23 40.6	59.6	173.2	22 41.0	59.6	173.2	21 41.4	59.6	173.3	20 41.8	59.6	173.3	19 42.2	59.6	173.4	18 42.6	59.6	173.4	17 43.0	59.6	173.5	27	24 40.2	59.6	173.1
28	23 40.5	59.6	173.3	22 40.9	59.6	173.3	21 41.3	59.6	173.3	20 41.7	59.6	173.4	19 42.1	59.6	173.4	18 42.5	59.6	173.5	17 42.9	59.6	173.5	16 43.3	59.6	173.5	28	23 40.5	59.6	173.3
29	22 40.8	59.6	173.4	21 41.2	59.6	173.4	20 41.6	59.6	173.5	19 42.0	59.6	173.5	18 42.4	59.6	173.5	17 42.8	59.6	173.6	16 43.2	59.6	173.6	15 43.5	59.6	173.6	29	22 40.8	59.6	173.4
30	21 41.2	59.6	173.5	20 41.5	59.6	173.5	19 41.9	59.6	173.6	18 42.3	59.6	173.6	17 42.7	59.6	173.6	16 43.0	59.6	173.7	15 43.4	59.6	173.7	14 43.8	59.6	173.7	30	21 41.2	59.6	173.5
31	20 41.5	59.6	173.6	19 41.8	59.6	173.6	18 42.2	59.6	173.7	17 42.6	59.6	173.7	16 42.9	59.6	173.7	15 43.2	59.6	173.8	14 43.6	59.6	173.8	13 44.0	59.6	173.8	31	20 41.5	59.6	173.6
32	19 41.8	59.6	173.7	18 42.5	59.6	173.8	17 42.8	59.6	173.8	16 42.9	59.6	173.8	15 43.2	59.6	173.8	14 43.6	59.6	173.9	13 43.9	59.6	173.9	12 44.2	59.6	173.9	32	19 41.8	59.6	173.7
33	18 42.1	59.6	173.8	17 42.5	59.6	173.8	16 42.8	59.6	173.9	15 43.1	59.6	173.9	14 43.5	59.6	173.9	13 43.8	59.6	174.0	12 44.1	59.6	174.0	11 44.4	59.6	174.0	33	18 42.1	59.6	173.8
34	17 42.4	59.6	173.9	16 42.7	59.6	173.9	15 43.1	59.6	174.0	14 43.4	59.6	174.0	13 43.7	59.6	174.0	12 44.1	59.6	174.1	11 44.4	59.6	174.1	10 44.7	59.6	174.1	34	17 42.4	59.6	173.9
35	16 42.7	59.6	174.0	15 43.0	59.6	174.1	14 43.3	59.6	174.1	13 43.6	59.6	174.2	12 44.0	59.6	174.2	11 44.3	59.6	174.2	10 44.6	59.6	174.2	9 44.9	59.6	174.2	35	16 42.7	59.6	174.0
36	15 43.0	59.6	174.1	14 43.3	59.6	174.1	13 43.6	59.6	174.2	12 43.9	59.6	174.3	11 44.2	59.6	174.3	10 44.5	59.6	174.3	9 44.8	59.6	174.3	8 45.2	59.6	174.3	36	15 43.0	59.6	174.1
37	14 43.3	59.6	174.2	13 43.6	59.6	174.2	12 43.9	59.6	174.3	11 44.2	59.6	174.3	10 44.5	59.6	174.3	9 44.8	59.6	174.3	8 45.1	59.6	174.3	7 45.4	59.6	174.3	37	14 43.3	59.6	174.2
38	13 43.6	59.6	174.3	12 43.9	59.6	174.3	11 44.2	59.6	174.4	10 44.5	59.6	174.4	9 44.8	59.6	174.4	8 45.1	59.6	174.4	7 45.3	59.6	174.4	6 45.6	59.6	174.4	38	13 43.6	59.6	174.3
39	12 43.9	59.6	174.4	11 44.2	59.6	174.4	10 44.5	59.6	174.5	9 44.7	59.6	174.5	8 45.0	59.6	174.5	7 45.3	59.6	174.5	6 45.6	59.6	174.5	5 45.8	59.6	174.5	39	12 43.9	59.6	174.4
40	11 44.2	59.6	174.5	10 44.5	59.6																							

18°, 342° L.H.A.

LATITUDE SAME NAME AS DECLINATION

N. Lor. { L.H.A. greater than 180° ..... Zn=Z
L.H.A. less than 180° ..... Zn=360°-Z

Main table with columns for Dec. (0-90) and latitude (38-45) and sub-columns for Hc, d, Z. Includes a secondary header at the bottom: 18°, 342° L.H.A. LATITUDE SAME NAME AS DECLINATION



LATITUDE CONTRARY NAME TO DECLINATION

L.H.A. 18°, 342°

Dec.	38°			39°			40°			41°			42°			43°			44°			45°			Dec.
	Hc	d	Z	Hc	d	Z	Hc	d	Z	Hc	d	Z	Hc	d	Z	Hc	d	Z	Hc	d	Z	Hc	d	Z	
0	48 32.5	-55.8	152.2	47 39.3	-56.1	152.7	46 45.9	-56.4	153.2	45 52.2	-56.5	153.7	44 58.4	-56.8	154.1	44 04.3	-57.0	154.5	43 10.0	-57.1	154.9	42 15.6	-57.4	155.3	0
1	47 36.7	-56.1	152.7	46 43.2	-56.3	153.2	45 49.5	-56.5	153.7	44 55.7	-56.8	154.1	44 01.6	-57.0	154.6	43 07.3	-57.1	155.0	42 12.9	-57.3	155.3	41 18.2	-57.4	155.7	1
2	46 40.6	-56.1	153.2	45 46.9	-56.3	153.7	44 53.0	-56.6	154.2	43 58.9	-56.8	154.6	43 04.7	-57.0	155.0	42 10.2	-57.2	155.4	41 15.6	-57.4	155.7	40 20.8	-57.5	156.1	2
3	45 44.5	-56.3	153.8	44 50.6	-56.6	154.2	43 56.4	-56.7	154.6	43 02.1	-56.9	155.0	42 07.7	-57.1	155.4	41 13.0	-57.2	155.8	40 18.2	-57.4	156.1	39 23.3	-57.6	156.5	3
4	44 48.2	-56.4	154.2	43 54.0	-56.6	154.7	42 59.7	-56.8	155.1	42 05.2	-57.0	155.5	41 10.6	-57.2	155.8	40 15.8	-57.4	156.2	39 20.8	-57.5	156.5	38 25.7	-57.7	156.8	4
5	43 51.8	-56.6	154.7	42 57.4	-56.7	155.1	42 02.9	-56.9	155.5	41 08.2	-57.1	155.9	40 13.4	-57.3	156.2	39 18.4	-57.4	156.6	38 23.3	-57.6	156.9	37 28.0	-57.7	157.2	5
6	42 55.2	-56.6	155.2	42 00.7	-56.8	155.6	41 06.0	-57.0	155.9	40 11.1	-57.2	156.3	39 16.1	-57.3	156.6	38 21.0	-57.5	156.9	37 25.7	-57.6	157.2	36 30.3	-57.7	157.5	6
7	41 58.6	-56.7	155.6	41 03.9	-57.0	156.0	40 09.0	-57.1	156.3	39 13.9	-57.2	156.7	38 18.8	-57.4	157.0	37 23.5	-57.6	157.3	36 28.1	-57.7	157.6	35 32.6	-57.9	157.9	7
8	41 01.9	-56.9	156.1	40 06.9	-57.1	156.4	39 11.9	-57.2	156.7	38 16.7	-57.3	157.1	37 21.4	-57.5	157.4	36 25.9	-57.6	157.6	35 30.4	-57.7	157.9	34 34.7	-57.8	158.2	8
9	40 05.0	-56.9	156.5	39 09.9	-57.1	156.8	38 14.7	-57.2	157.1	37 19.4	-57.4	157.4	36 23.9	-57.5	157.7	35 28.3	-57.6	158.0	34 32.7	-57.8	158.3	33 36.9	-57.9	158.5	9
10	39 08.1	-57.0	156.9	38 12.8	-57.1	157.2	37 17.5	-57.4	157.5	36 22.0	-57.5	157.8	35 26.4	-57.6	158.1	34 30.7	-57.8	158.3	33 34.9	-57.9	158.6	32 39.0	-58.0	158.8	10
11	38 11.1	-57.1	157.3	37 15.7	-57.2	157.6	36 20.1	-57.3	157.9	35 24.5	-57.5	158.2	34 28.8	-57.7	158.4	33 32.9	-57.7	158.7	32 37.0	-57.9	158.9	31 41.0	-58.0	159.1	11
12	37 14.0	-57.2	157.7	36 18.4	-57.3	158.0	35 22.8	-57.5	158.2	34 27.0	-57.6	158.5	33 31.1	-57.7	158.7	32 35.2	-57.8	159.0	31 39.1	-57.9	159.2	30 43.0	-58.0	159.4	12
13	36 16.8	-57.2	158.1	35 21.1	-57.3	158.3	34 25.3	-57.5	158.6	33 29.4	-57.6	158.8	32 33.4	-57.7	159.1	31 37.3	-57.8	159.3	30 41.2	-58.0	159.5	29 44.9	-58.1	159.7	13
14	35 19.6	-57.3	158.4	34 23.8	-57.5	158.7	33 27.8	-57.5	158.9	32 31.8	-57.7	159.2	31 35.7	-57.8	159.4	30 39.5	-58.0	159.6	29 43.2	-58.0	159.8	28 46.8	-58.1	160.0	14
15	34 22.3	-57.4	158.8	33 26.3	-57.5	159.0	32 30.3	-57.7	159.3	31 34.1	-57.7	159.5	30 37.9	-57.9	159.7	29 41.5	-57.9	159.9	28 45.2	-58.1	160.1	27 48.7	-58.1	160.3	15
16	33 24.9	-57.4	159.2	32 28.8	-57.5	159.4	31 32.6	-57.6	159.6	30 36.4	-57.8	159.8	29 40.0	-57.9	160.0	28 43.6	-58.0	160.2	27 47.1	-58.1	160.4	26 50.4	-58.2	160.6	16
17	32 27.5	-57.4	159.5	31 31.3	-57.6	159.7	30 35.0	-57.7	159.9	29 38.6	-57.8	160.1	28 42.1	-57.9	160.3	27 45.6	-58.0	160.5	26 49.0	-58.1	160.7	25 52.4	-58.2	160.8	17
18	31 30.1	-57.5	159.8	30 33.7	-57.6	160.0	29 37.3	-57.8	160.2	28 40.8	-57.9	160.4	27 44.2	-58.0	160.6	26 47.6	-58.1	160.8	25 50.9	-58.2	160.9	24 54.2	-58.3	161.1	18
19	30 32.5	-57.5	160.2	29 36.1	-57.7	160.4	28 39.5	-57.8	160.6	27 42.9	-57.9	160.7	26 46.2	-58.0	160.9	25 49.5	-58.1	161.1	24 52.7	-58.2	161.2	23 55.9	-58.3	161.4	19
20	29 35.0	-57.7	160.5	28 38.4	-57.8	160.7	27 41.7	-57.8	160.9	26 45.0	-57.9	161.0	25 48.2	-58.0	161.2	24 51.4	-58.1	161.3	23 54.5	-58.2	161.5	22 57.6	-58.3	161.6	20
21	28 37.3	-57.6	160.8	27 40.6	-57.7	161.0	26 43.9	-57.9	161.2	25 47.1	-58.0	161.3	24 50.2	-58.1	161.5	23 53.3	-58.2	161.6	22 56.3	-58.3	161.7	21 59.3	-58.3	161.9	21
22	27 39.7	-57.6	161.1	26 42.9	-57.8	161.3	25 46.0	-57.9	161.4	24 49.1	-58.0	161.6	23 52.1	-58.1	161.7	22 55.1	-58.1	161.9	21 58.1	-58.3	162.0	21 01.0	-58.3	162.1	22
23	26 42.0	-57.8	161.4	25 45.1	-57.9	161.6	24 48.1	-57.9	161.7	23 51.1	-58.0	161.9	22 54.1	-58.1	162.0	21 57.0	-58.2	162.1	20 59.8	-58.3	162.3	20 02.7	-58.4	162.4	23
24	25 44.2	-57.8	161.7	24 47.2	-57.9	161.9	23 50.2	-58.0	162.0	22 53.2	-58.0	162.2	21 55.0	-58.1	162.4	20 57.8	-58.2	162.5	20 01.5	-58.3	162.5	19 04.3	-58.4	162.6	24
25	24 46.4	-57.8	162.0	23 49.3	-57.9	162.2	22 52.2	-58.0	162.3	21 55.0	-58.1	162.4	20 57.8	-58.2	162.5	19 59.6	-58.3	162.6	19 02.3	-58.3	162.8	18 05.9	-58.4	162.9	25
26	23 48.6	-57.8	162.3	22 51.4	-57.9	162.5	21 54.2	-58.0	162.6	20 56.9	-58.1	162.7	19 59.6	-58.2	162.8	19 02.3	-58.3	162.9	18 04.9	-58.3	163.0	17 07.5	-58.4	163.1	26
27	22 50.8	-57.9	162.6	21 53.5	-58.0	162.7	20 56.2	-58.0	162.9	19 58.8	-58.1	163.0	19 01.4	-58.2	163.1	18 04.0	-58.3	163.2	17 06.6	-58.4	163.3	16 09.1	-58.4	163.3	27
28	21 52.9	-57.9	162.9	20 55.5	-58.0	163.0	19 58.1	-58.1	163.1	19 00.7	-58.2	163.2	18 03.2	-58.2	163.3	17 05.7	-58.3	163.4	16 08.2	-58.4	163.5	15 10.7	-58.4	163.6	28
29	20 55.0	-58.0	163.2	19 57.5	-58.0	163.3	19 00.0	-58.1	163.4	18 02.5	-58.2	163.5	17 05.0	-58.3	163.6	16 07.4	-58.3	163.7	15 09.8	-58.4	163.7	14 12.2	-58.4	163.8	29
30	19 57.0	-57.9	163.5	18 59.5	-58.1	163.6	18 01.9	-58.1	163.7	17 04.3	-58.2	163.7	16 06.7	-58.2	163.8	15 09.1	-58.3	163.9	14 11.4	-58.4	164.0	13 13.8	-58.5	164.0	30
31	18 59.1	-58.0	163.7	18 01.4	-58.0	163.8	17 03.8	-58.1	163.9	16 06.1	-58.2	163.9	15 08.5	-58.2	164.1	14 10.8	-58.4	164.1	13 13.0	-58.4	164.2	12 15.3	-58.5	164.3	31
32	18 01.1	-58.0	164.0	17 03.4	-58.1	164.1	16 05.7	-58.2	164.2	15 07.9	-58.2	164.2	14 10.2	-58.3	164.3	13 12.4	-58.4	164.4	12 14.6	-58.4	164.4	11 16.8	-58.5	164.4	32
33	17 03.1	-58.1	164.3	16 05.3	-58.1	164.4	15 07.5	-58.2	164.4	14 09.7	-58.2	164.4	13 11.9	-58.3	164.6	12 14.0	-58.4	164.6	11 16.2	-58.4	164.6	10 18.3	-58.5	164.7	33
34	16 05.0	-58.0	164.5	15 07.2	-58.1	164.6	14 09.3	-58.2	164.7	13 11.5	-58.3	164.7	12 13.6	-58.4	164.8	11 15.6	-58.3	164.9	10 17.7	-58.4	164.9	9 19.9	-58.5	165.0	34
35	15 07.0	-58.1	164.8	14 09.1	-58.2	164.9	13 11.1	-58.2	164.9	12 13.2	-58.3	165.0	11 15.2	-58.3	165.0	10 17.3	-58.4	165.1	9 19.3	-58.5	165.1	8 21.3	-58.5	165.2	35
36	14 08.9	-58.1	165.1	13 10.9	-58.2	165.1	12 12.9	-58.2	165.2	11 14.9	-58.3	165.2	10 16.9	-58.3	165.3	9 18.9	-58.4	165.3	8 20.8	-58.5	165.4	7 22.8	-58.5	165.4	36
37	13 10.8	-58.1	165.3	12 12.8	-58.2	165.4	11 14.7	-58.2	165.4	10 16.6	-58.3	165.5	9 18.5	-58.3	165.5	8 20.4	-58.4	165.6	7 22.3	-58.5	165.6	6 24.2	-58.5	165.6	37
38	12 12.7	-58.1	165.6	11 14.6	-58.2	165.6	10 16.5	-58.3	165.7	9 18.3	-58.3	165.7	8 20.2	-58.3	165.8	7 22.0	-58.4	165.8	6 23.9	-58.5	165.8	5 25.7	-58.5	165.8	38
39	11 14.6	-58.1	165.8	10 16.4	-58.2	165.9	9 18.2	-58.2	165.9	8 20.0	-58.3	166.0	7 21.8	-58.3	166.0	6 23.6	-58.4	166.0	5 25.4	-58.5	166.0	4 27.2	-58.6	166.1	39
40	10 16.5	-58.2	166.1	9 18.2	-58.2	166.1	8 20.0	-58.3	166.2	7 21.7	-58.3	166.2	6 23.5	-58.4	166.2	5 25.2	-58.5	166.2	4 26.9	-58.5	166.2	3 28.6	-58.6	166.3	40
41	9 18.3	-58.1	166.3	8 20.0	-58.2	166.4	7 21.7	-58.2	166.4	6 23.4	-58.3	166.4	5 25.1	-58.4	166.4	4 26.7	-58.4	166.5	3 28.4	-58.5	166.5	2 30.1	-58.6	166.5	41
42	8 20.2	-58.2	166.6	7 21.8	-58.2	166.6	6 23.5	-58.3	166.6	5 25.2	-58.4	166.7	4 26.9	-58.4	166.7	3 28.3	-58.4	166.7	2 29.9	-58.5	166.7	1 31.5	-58.6	166.7	42
43	7 22.0	-58.1	166.8	6 23.6	-58.2	166.9	5 25.2	-58.3	166.9	4 26.7	-58.3	166.9	3 28.3	-58.3	166.9	2 29.9	-58.5	166.9	1 31.4	-58.5	166.9	0 33.0	-58.6	166.9	43
44	6 23.9	-58.2	167.1	5 25.4	-58.2	167.1	4 26.9	-58.3	167.1	3 28.4	-58.3	167.1	2 29.9	-58.4	167.1	1 31.4	-58.4	167.2	0 32.9	-58.5	167.2	0 25.6	-58.5	167.2	44
45	5 25.7	-58.2																							

44°, 316° L.H.A.

LATITUDE SAME NAME AS DECLINATION

N. Lat. { L.H.A. greater than 180°.....Zn=Z
L.H.A. less than 180°.....Zn=360°-Z

Main table with columns for Dec. (0-90), 38°, 39°, 40°, 41°, 42°, 43°, 44°, 45°, and Dec. (90-0). Each degree column contains three sub-columns (Hc, d, Z) with numerical values.

44°, 316° L.H.A.

LATITUDE SAME NAME AS DECLINATION

LATITUDE CONTRARY NAME TO DECLINATION

L.H.A. 44°, 316°

Dec.	38°			39°			40°			41°			42°			43°			44°			45°			Dec.
	Hc	d	Z	Hc	d	Z	Hc	d	Z	Hc	d	Z	Hc	d	Z	Hc	d	Z	Hc	d	Z	Hc	d	Z	
0	34 31 8	45 0	122 5	33 59 3	45 7	123 1	33 26 3	46 3	123 6	32 52 8	47 0	124 2	32 18 9	47 6	124 7	31 44 5	48 2	125 2	31 09 7	48 8	125 7	30 34 4	49 3	126 2	0
1	33 46 8	45 3	123 3	33 13 6	45 9	123 9	32 40 0	46 7	124 4	32 05 8	47 2	124 9	31 31 3	47 9	125 4	30 56 3	48 5	125 9	30 20 9	49 1	126 4	29 45 1	49 6	126 9	1
2	33 01 5	45 5	124 1	32 27 7	46 3	124 6	31 53 3	46 8	125 2	31 18 6	47 5	125 7	30 43 4	48 1	126 1	30 07 8	48 6	126 6	29 31 8	49 2	127 1	28 55 5	49 8	127 5	2
3	32 16 0	45 9	124 9	31 41 4	46 5	125 4	31 06 5	47 1	125 9	30 31 1	47 7	126 4	29 55 3	48 3	126 8	29 19 2	48 9	127 3	28 42 6	49 4	127 7	28 05 7	49 9	128 2	3
4	31 30 1	46 1	125 6	30 54 9	46 7	126 1	30 19 3	47 3	126 6	29 43 4	48 0	127 1	29 07 0	48 5	127 5	28 30 3	49 0	127 9	27 53 2	49 5	128 4	27 15 8	50 1	128 8	4
5	30 44 0	46 4	126 4	30 08 2	47 0	126 9	29 32 0	47 6	127 3	28 55 4	48 1	127 8	28 15 5	48 7	128 2	27 41 3	49 3	128 6	27 03 7	49 8	129 0	26 25 7	50 2	129 4	5
6	29 57 6	46 7	127 1	29 21 2	47 2	127 6	28 44 4	47 8	128 0	28 07 3	48 4	128 4	27 29 8	48 9	128 8	26 52 0	49 4	129 2	26 13 9	49 9	129 6	25 35 5	50 4	130 0	6
7	29 10 9	46 8	127 8	28 34 0	47 5	128 3	27 56 6	48 0	128 7	27 18 9	48 5	129 1	26 40 9	49 0	129 5	26 02 6	49 5	129 9	25 24 0	50 1	130 2	24 45 1	50 5	130 6	7
8	28 24 1	47 1	128 6	27 46 5	47 6	129 0	27 08 6	48 2	129 4	26 30 4	48 7	129 8	25 51 9	49 2	130 2	25 13 1	49 8	130 5	24 33 9	50 2	130 8	23 54 5	50 7	131 2	8
9	27 37 0	47 3	129 3	26 58 9	47 8	129 7	26 20 4	48 3	130 0	25 41 7	48 9	130 4	25 02 7	49 4	130 8	24 23 3	49 8	131 1	23 43 7	50 3	131 5	23 03 9	50 8	131 8	9
10	26 49 7	47 5	129 9	26 11 1	48 1	130 3	25 32 1	48 6	130 7	24 52 8	49 0	131 1	24 13 3	49 6	131 4	23 33 5	50 1	131 7	22 53 4	50 5	132 0	22 13 1	50 9	132 4	10
11	26 02 2	47 6	130 6	25 23 0	48 2	131 0	24 43 5	48 7	131 3	24 03 8	49 2	131 7	23 23 7	49 7	132 0	22 43 4	50 1	132 3	22 02 9	50 6	132 6	21 22 5	51 0	132 9	11
12	25 14 6	47 9	131 3	24 34 8	48 3	131 7	23 54 8	48 8	132 0	23 14 6	49 4	132 3	22 34 1	49 9	132 6	21 53 3	50 3	132 9	20 31 1	51 2	133 2	20 01 1	51 5	133 5	12
13	24 26 7	48 0	132 0	23 46 5	48 5	132 3	23 06 0	49 1	132 6	22 25 2	49 5	132 9	21 44 2	49 9	133 2	20 30 0	50 4	133 5	19 07 6	50 8	133 8	18 15 5	51 8	134 1	13
14	23 38 7	48 1	132 6	22 57 9	48 6	132 9	22 16 9	49 1	133 2	21 35 7	49 6	133 5	20 54 3	50 1	133 8	19 23 0	50 5	134 1	17 30 8	50 9	134 3	16 43 8	51 4	134 6	14
15	22 50 5	48 3	133 3	22 09 3	48 9	133 6	21 27 8	49 1	133 9	20 46 1	49 7	134 1	19 14 2	50 2	134 4	18 22 1	50 6	134 7	16 39 9	51 0	134 9	15 57 4	51 4	135 1	15
16	22 02 2	48 5	133 9	21 20 4	48 9	134 2	20 38 5	49 4	134 5	19 56 4	49 9	134 7	18 04 0	50 2	135 0	17 31 5	50 7	135 2	16 48 9	51 2	135 5	15 06 0	51 8	135 7	16
17	21 13 7	48 7	134 5	20 31 5	49 1	134 8	19 49 1	49 6	135 1	19 06 5	50 0	135 3	17 23 8	50 4	135 6	16 40 8	50 8	135 8	16 57 7	51 3	136 0	14 14 5	51 9	136 2	17
18	20 25 0	48 7	135 2	19 42 4	49 2	135 4	18 59 5	49 9	135 7	18 16 5	50 0	135 9	16 15 3	50 3	136 1	16 50 0	50 9	136 4	16 06 5	51 3	136 6	13 22 9	51 9	136 7	18
19	19 36 3	48 9	135 8	18 53 2	49 4	136 0	18 09 9	49 8	136 3	17 26 5	50 2	136 5	16 27 9	50 6	136 7	15 59 1	51 0	136 9	15 15 2	51 3	137 1	14 31 2	51 9	137 3	19
20	18 47 4	49 0	136 4	18 03 8	49 6	136 6	17 20 1	49 8	136 9	16 36 3	50 3	137 1	15 52 3	50 7	137 3	15 08 1	51 0	137 5	14 23 9	51 5	137 6	13 39 5	51 8	137 8	20
21	17 58 4	49 2	137 0	17 14 4	49 8	137 2	16 30 3	50 0	137 4	15 46 0	50 3	137 6	15 01 6	50 7	137 8	14 17 1	51 1	138 0	13 32 4	51 5	138 2	12 47 7	51 9	138 3	21
22	17 09 2	49 2	137 6	16 24 8	49 8	137 8	15 40 3	50 0	138 0	14 55 7	50 5	138 2	14 10 9	50 9	138 4	13 26 0	51 2	138 5	12 40 9	51 5	138 7	11 55 8	51 9	138 8	22
23	16 20 0	49 3	138 2	15 35 2	49 9	138 4	14 50 3	50 0	138 6	14 05 2	50 5	138 8	13 20 0	50 9	138 9	12 34 8	51 3	139 1	11 49 4	51 8	139 2	11 03 9	52 0	139 3	23
24	15 30 7	49 4	138 8	14 45 5	49 9	139 0	14 00 1	50 1	139 2	13 14 7	50 6	139 3	12 29 1	50 9	139 5	11 43 5	51 3	139 6	10 57 8	51 7	139 7	10 11 9	52 0	139 9	24
25	14 41 3	49 6	139 4	13 55 6	49 9	139 6	13 09 9	50 1	139 7	12 24 1	50 6	139 9	11 38 2	51 0	140 0	10 52 2	51 4	140 1	10 06 6	51 7	140 2	9 19 9	52 0	140 4	25
26	13 51 7	49 6	140 0	13 05 7	49 9	140 1	12 19 6	50 1	140 3	11 33 5	50 8	140 4	10 47 2	51 1	140 5	10 00 8	51 4	140 7	9 14 4	51 8	140 8	8 27 9	52 1	140 9	26
27	13 02 1	49 6	140 6	12 15 8	50 1	140 7	11 29 3	50 1	140 8	10 42 7	50 7	141 0	9 56 1	51 1	141 1	9 09 4	51 5	141 2	8 22 6	51 8	141 3	7 35 9	52 1	141 4	27
28	12 12 5	49 8	141 1	11 25 7	50 1	141 3	10 38 9	50 5	141 4	9 52 0	50 9	141 5	9 05 0	51 2	141 6	8 17 9	51 5	141 7	7 30 8	51 8	141 8	6 43 6	52 1	141 9	28
29	11 22 7	49 8	141 7	10 35 6	50 2	141 8	9 48 4	50 5	141 9	9 01 1	50 8	142 0	8 13 8	51 2	142 1	7 26 4	51 5	142 2	6 39 0	51 9	142 3	5 51 5	52 2	142 4	29
30	10 32 9	49 8	142 3	9 45 4	50 2	142 4	8 57 9	50 6	142 5	8 10 3	50 9	142 6	7 22 6	51 3	142 7	6 34 9	51 6	142 7	5 47 1	51 9	142 8	4 59 3	52 2	142 9	30
31	9 43 1	50 0	142 8	8 55 2	50 3	142 9	8 07 3	50 6	143 0	7 19 4	51 0	143 2	6 31 3	51 2	143 2	5 43 3	51 6	143 2	4 55 2	51 9	143 3	4 07 1	52 2	143 3	31
32	8 53 1	49 9	143 4	8 04 9	50 3	143 5	7 16 7	50 7	143 6	6 28 4	50 9	143 6	5 40 1	51 3	143 7	4 51 7	51 6	143 8	4 03 3	52 0	143 8	3 14 9	52 2	143 8	32
33	8 03 2	50 1	144 0	7 14 6	50 3	144 0	6 26 0	50 6	144 1	5 37 4	51 0	144 2	4 48 8	51 4	144 2	4 00 1	51 7	144 3	3 11 3	51 9	144 3	2 22 6	52 2	144 3	33
34	7 13 1	50 0	144 5	6 24 3	50 4	144 6	5 35 4	50 8	144 6	4 46 4	50 9	144 7	3 57 4	51 3	144 7	3 08 4	51 6	144 8	2 19 4	52 0	144 8	1 30 4	52 3	144 8	34
35	6 23 1	50 0	145 1	5 33 9	50 4	145 1	4 44 6	50 7	145 2	3 55 4	51 1	145 2	3 06 1	51 4	145 3	2 16 8	51 7	145 3	1 27 4	51 9	145 3	0 38 1	52 3	145 3	35
36	5 33 0	50 1	145 6	4 43 5	50 5	145 7	3 53 9	50 8	145 7	3 04 3	51 1	145 8	2 14 3	51 4	145 8	1 25 1	51 7	145 8	0 35 5	52 0	145 8	0 14 2	52 3	145 8	36
37	4 42 9	50 2	146 2	3 53 0	50 5	146 2	3 03 1	50 7	146 3	2 13 2	51 0	146 3	1 23 7	51 4	146 3	0 33 4	51 7	146 3	0 16 5	52 0	146 3	0 04 2	52 3	146 3	37
38	3 52 7	50 2	146 7	3 02 5	50 4	146 8	2 12 4	50 8	146 8	1 22 2	51 1	146 8	0 31 9	51 3	146 8	0 18 3	51 6	146 8	0 08 5	51 9	146 8	0 00 0	52 3	146 8	38
39	3 02 5	50 1	147 3	2 12 1	50 4	147 3	1 21 6	50 8	147 3	0 31 1	51 1	147 3	0 19 4	51 4	147 3	0 09 9	51 7	147 3	0 00 4	52 0	147 3	0 00 0	52 3	147 3	39
40	2 12 4	50 3	147 8	1 21 6	50 5	147 8	0 30 8	50 8	147 8	0 20 0	51 1	147 8	0 10 2	51 4	147 8	0 01 6	51 7	147 8	0 00 0	52 0	147 8	0 00 0	52 3	147 8	40
41	1 22 2	50 3	148 4	0 31 1	50 5	148 4	0 20 0	50 8	148 4	1 11 1	51 1	148 4	2 02 8	51 4	148 4	2 53 6	51 7	148 4	3 44 9	51 9	148 4	4 36 3	52 0	148 4	41
42	0 31 9	50 2	148 9	0 19 4	50 5	148 9	1 10 8	50 8	148 9	2 02 2	51 1	148 9	2 53 6	51 4	148 9	3 44 9	51 7	148 9	4 36 3	52 0	148 9	5 28 2	52 0	148 9	42
43	0 18 3	50 2	150 5	1 09 9	50 5	150 5	2 01 6	50 8	150 5	2 53 3	51 0	150 5	3 44 9	51 4	150 5	4 36 3	51 8	150 5	5 28 2	51 9	150 5	6 19 8	52 1	150 5	43
44	1 08 5	50 2	150 0	2 00 4	50 5	150 0	2 52 4	50 8	150 0	3 44 3	51 1	150 0	4 36 3	51 3	150 0	5 28 2	51 6	150 0	6 20 1	51 8	150 0	7 11 9	52 1	150 0	44
45	1 58 7	50 2	150 4	2 50 9	50 5	150 4	3 43 2	50 7	150 4	4 35 4															



55°, 305° L.H.A.

LATITUDE SAME NAME AS DECLINATION

N. Lat. { L.H.A. greater than 180° ..... Zn=Z  
L.H.A. less than 180° ..... Zn=360°-Z

Table with columns for Declination (0-90) and Latitude (38-45). Each cell contains three values (Hc, d, Z) for each degree of latitude. The table is organized in a grid with 90 rows and 14 columns.

55°, 305° L.H.A.

LATITUDE SAME NAME AS DECLINATION

LATITUDE CONTRARY NAME TO DECLINATION

L.H.A. 55°, 305°

Dec.	38°			39°			40°			41°			42°			43°			44°			45°			Dec.
	Hc	d	Z	Hc	d	Z	Hc	d	Z	Hc	d	Z	Hc	d	Z	Hc	d	Z	Hc	d	Z	Hc	d	Z	
0	26 52.3	416	113.3	26 28.3	423	113.8	26 03.9	431	114.2	25 39.0	437	114.7	25 13.8	445	115.1	24 48.1	451	115.5	24 22.1	459	115.9	23 55.6	465	116.3	0
1	26 10.7	418	114.1	25 46.0	426	114.6	25 20.8	433	115.0	24 55.3	441	115.4	24 29.3	447	115.8	24 03.0	454	116.2	23 36.2	460	116.6	23 09.1	466	117.0	1
2	25 28.9	421	114.9	25 03.4	428	115.4	24 37.5	435	115.8	24 11.2	442	116.2	23 44.6	449	116.6	23 17.6	456	117.0	22 50.2	462	117.3	22 22.5	468	117.7	2
3	24 46.8	423	115.7	24 20.6	430	116.1	23 54.0	437	116.5	23 27.0	444	116.9	22 59.7	451	117.3	22 32.0	458	117.7	22 04.0	464	118.0	21 35.6	470	118.4	3
4	24 04.5	425	116.5	23 37.6	433	116.9	23 10.3	440	117.3	22 42.6	446	117.6	22 14.6	453	118.0	21 46.2	459	118.4	21 17.6	466	118.7	20 48.6	472	119.1	4
5	23 22.0	428	117.3	22 54.3	435	117.6	22 26.3	441	118.0	21 58.0	449	118.4	21 29.3	455	118.7	21 00.3	461	119.1	20 31.0	467	119.4	20 01.4	473	119.7	5
6	22 39.2	430	118.0	22 10.8	436	118.4	21 42.2	444	118.7	21 13.1	451	119.1	20 43.8	456	119.4	20 14.2	462	119.7	19 44.3	469	120.1	19 14.1	474	120.4	6
7	21 56.2	432	118.8	21 27.2	439	119.1	20 57.8	445	119.5	20 28.2	452	119.8	19 58.2	458	120.1	19 28.0	465	120.4	18 57.4	470	120.7	18 27.6	476	121.0	7
8	21 13.0	434	119.5	20 43.3	440	119.9	20 13.3	447	120.2	19 43.0	453	120.5	19 12.4	459	120.8	18 41.5	465	121.1	18 10.4	471	121.4	17 39.1	477	121.7	8
9	20 29.6	435	120.3	19 59.3	441	120.6	19 28.6	449	120.9	18 57.7	455	121.2	18 26.5	461	121.5	17 55.0	467	121.8	17 23.3	473	122.0	16 51.4	478	122.3	9
10	19 46.1	438	121.3	19 15.0	444	121.3	18 43.7	450	121.6	18 12.2	457	121.9	17 40.4	463	122.1	17 08.3	468	122.4	16 36.0	473	122.7	16 03.6	480	122.9	10
11	19 02.3	439	121.7	18 30.6	445	122.0	17 58.7	451	122.3	17 26.5	457	122.6	16 54.1	463	122.8	16 21.5	469	123.1	15 48.7	475	123.3	15 15.6	480	123.5	11
12	18 18.4	441	122.4	17 46.1	447	122.7	17 13.6	453	123.0	16 40.8	459	123.2	16 07.8	465	123.5	15 34.6	470	123.7	15 01.2	476	123.9	14 27.6	481	124.2	12
13	17 34.3	442	123.2	17 01.4	448	123.4	16 28.3	455	123.7	15 54.9	460	123.9	15 21.3	466	124.1	14 47.6	472	124.4	14 13.6	477	124.6	13 39.5	483	124.8	13
14	16 50.1	444	123.9	16 16.6	450	124.1	15 42.8	455	124.3	15 08.9	462	124.6	14 34.7	467	124.8	14 00.4	472	125.0	13 25.9	478	125.2	12 51.2	483	125.4	14
15	16 05.7	445	124.6	15 31.6	451	124.8	14 57.3	457	125.0	14 22.7	462	125.2	13 48.0	468	125.4	13 13.2	474	125.6	12 38.1	478	125.8	12 02.9	483	126.0	15
16	15 21.2	446	125.3	14 46.5	452	125.5	14 11.6	458	125.7	13 36.5	464	125.9	13 01.2	469	126.1	12 25.8	474	126.3	11 50.3	480	126.4	11 14.6	485	126.6	16
17	14 36.6	448	125.9	14 01.3	454	126.2	13 25.8	459	126.4	12 50.1	465	126.5	12 14.3	470	126.7	11 27.4	475	126.9	11 02.3	480	127.0	10 26.1	485	127.2	17
18	13 51.8	449	126.6	13 15.9	455	126.8	12 39.9	460	127.0	12 03.7	465	127.2	11 27.4	471	127.4	10 50.9	476	127.5	10 14.3	481	127.7	9 37.6	486	127.8	18
19	13 06.9	449	127.3	12 30.5	455	127.5	11 53.9	461	127.7	11 17.2	467	127.8	10 40.3	471	128.0	10 03.3	476	128.1	9 26.2	481	128.3	8 49.0	486	128.4	19
20	12 22.0	451	128.0	11 45.0	457	128.2	11 07.8	461	128.3	10 30.5	466	128.5	9 53.2	472	128.6	9 15.7	478	128.7	8 38.1	483	128.9	8 00.4	487	129.0	20
21	11 36.9	452	128.7	11 00.3	457	128.8	10 21.7	463	129.0	9 43.9	468	129.1	9 06.0	473	129.2	8 27.9	477	129.4	7 49.8	482	129.5	7 11.7	488	129.6	21
22	10 51.7	452	129.3	10 13.6	458	129.5	9 35.4	463	129.6	8 57.1	468	129.7	8 18.7	474	129.9	7 40.2	478	130.0	7 01.6	483	130.1	6 22.9	487	130.2	22
23	10 06.5	454	130.0	9 27.8	458	130.1	8 49.1	464	130.3	8 10.3	469	130.4	7 31.3	473	130.5	6 52.4	479	130.6	6 13.3	484	130.7	5 34.2	489	130.7	23
24	9 21.1	454	130.7	8 42.0	460	130.8	8 02.7	464	130.9	7 23.4	470	131.0	6 44.0	475	131.1	6 04.5	479	131.2	5 24.9	483	131.3	4 45.3	488	131.3	24
25	8 35.7	455	131.3	7 56.0	460	131.4	7 16.3	465	131.5	6 36.4	470	131.6	5 56.5	474	131.7	5 16.6	480	131.8	4 36.6	484	131.9	3 56.5	489	131.9	25
26	7 50.2	455	132.0	7 10.0	460	132.1	6 29.8	466	132.2	5 49.4	470	132.3	5 09.1	475	132.3	4 28.6	479	132.4	3 48.2	485	132.4	3 07.6	488	132.5	26
27	7 04.7	456	132.7	6 24.0	461	132.7	5 43.2	466	132.8	5 02.4	470	132.9	4 21.6	476	132.9	3 40.7	480	133.0	2 59.7	484	133.0	2 18.8	489	133.1	27
28	6 19.1	457	133.3	5 37.9	462	133.4	4 56.6	466	133.5	4 15.4	471	133.5	3 34.0	475	133.6	2 52.7	480	133.6	2 11.3	485	133.6	1 29.9	489	133.7	28
29	5 33.4	457	134.0	4 51.7	461	134.0	4 10.0	466	134.1	3 28.3	472	134.1	2 46.5	476	134.2	2 04.7	481	134.2	1 22.8	485	134.2	0 41.0	489	134.2	29
30	4 47.7	457	134.6	4 05.6	462	134.7	3 23.4	467	134.7	2 41.1	471	134.7	1 58.9	476	134.8	1 16.6	480	134.8	0 34.3	484	134.8	0 07.9	490	134.8	30
31	4 02.0	458	135.3	3 19.4	463	135.3	2 36.7	467	135.3	1 54.0	471	135.4	1 11.3	476	135.4	0 28.6	480	135.4	0 14.1	485	135.4	0 56.9	489	135.4	31
32	3 16.2	457	135.9	2 33.1	462	135.9	1 50.0	467	136.0	1 06.9	472	136.0	0 23.7	476	136.0	0 19.5	480	136.0	1 02.6	485	136.0	1 45.8	489	136.0	32
33	2 30.5	458	136.6	1 46.9	463	136.6	1 03.3	467	136.6	0 19.7	472	136.6	0 23.9	476	136.6	1 07.5	480	136.6	1 51.1	484	136.6	2 34.6	489	136.6	33
34	1 44.7	458	137.2	1 00.6	463	137.2	0 16.6	467	137.2	0 27.5	471	137.2	1 11.5	476	137.2	1 55.5	480	137.2	2 39.5	485	137.2	3 23.5	489	137.2	34
35	0 58.8	458	137.8	0 14.4	463	137.9	0 30.1	467	137.9	1 14.6	472	137.9	1 59.1	476	137.9	1 51.5	480	137.9	2 43.5	484	137.9	3 28.0	488	137.9	35
36	0 13.0	458	138.5	0 31.9	463	138.5	1 16.8	467	138.5	2 01.8	471	138.5	2 46.7	475	138.5	3 31.5	480	138.5	4 16.4	484	138.5	5 01.2	488	138.5	36
37	0 32.8	458	139.1	1 18.2	462	139.1	2 03.5	467	139.1	2 48.9	471	139.1	3 34.2	476	139.1	4 19.5	480	139.1	5 04.8	483	139.1	5 50.0	488	139.1	37
38	1 18.6	458	140.2	2 04.4	463	140.2	2 50.2	467	140.2	3 36.0	471	140.2	4 21.8	475	140.2	5 07.5	479	140.2	5 53.1	484	140.2	6 38.8	487	140.2	38
39	2 04.4	458	139.6	2 50.7	462	139.6	3 36.9	466	139.6	4 23.1	471	139.6	5 09.3	474	139.6	5 55.4	479	139.6	6 41.5	482	139.6	7 27.5	487	139.6	39
40	2 50.2	458	138.9	3 36.9	462	139.0	4 23.5	466	139.0	5 10.2	470	139.1	5 56.7	475	139.1	6 43.3	478	139.2	7 29.7	483	139.3	8 16.2	488	139.3	40
41	3 36.0	458	138.3	4 23.3	462	138.7	5 10.2	466	138.4	5 57.2	470	138.4	6 44.2	473	138.5	7 31.1	478	138.6	8 18.0	481	138.7	9 04.8	485	138.8	41
42	4 21.8	457	137.6	5 09.3	461	137.7	5 56.7	466	137.7	6 44.2	469	137.8	7 31.5	474	137.9	8 18.9	477	138.0	9 06.1	482	138.1	9 53.3	485	138.2	42
43	5 07.5	456	137.0	5 55.4	461	137.0	6 43.3	464	137.1	7 31.1	469	137.2	8 18.9	472	137.3	9 06.6	477	137.4	9 54.3	480	137.5	10 41.8	485	137.6	43
44	5 53.1	457	136.3	6 41.5	460	136.4	7 29.7	465	136.5	8 18.0	468	136.5	9 06.1	472	136.6	9 54.3	475	136.7	10 42.3	480	136.8	11 30.3	485	136.9	44
45	6 38.8	455	135.7	7 27.5	460	135.7	8 16.2	463	135.8	9 04.8	467	135.9	9 53.3	472	136.0	10 41.8	476	136.1	11 30.3	479	136.2	12 18.6	483	136.4	45
46	7 24.3	456	135.0	8 13.5	459	135.1	9 02.5	463	135.2	9 51.5	467	135.3	10 40.5	470	135.4	11 29.4	474	135.5	12 18.2	478	135.6	13 06.8	482	135.8	46
47																									

82°, 278° L.H.A.

LATITUDE SAME NAME AS DECLINATION

N. Lat. { L.H.A. greater than 180°.....Zn=Z  
L.H.A. less than 180°.....Zn=360°-Z

Table with columns for Declination (0-90) and Latitude (38-45). Each cell contains three values (M, d, Z) for a specific declination and latitude combination.

82°, 278° L.H.A.

LATITUDE SAME NAME AS DECLINATION

LATITUDE CONTRARY NAME TO DECLINATION

L.H.A. 82°, 278°

Dec.	38°			39°			40°			41°			42°			43°			44°			45°			Dec.
	Hc	d	Z	Hc	d	Z	Hc	d	Z	Hc	d	Z	Hc	d	Z	Hc	d	Z	Hc	d	Z	Hc	d	Z	
0	6 17.8	37.2	94.9	6 12.5	38.0	95.1	6 07.2	38.8	95.2	6 01.8	39.7	95.3	5 56.2	40.4	95.4	5 50.5	41.1	95.5	5 44.7	41.9	95.6	5 38.9	42.7	95.7	0
1	5 40.6	37.3	95.7	5 34.5	38.0	95.8	5 28.4	38.9	95.9	5 22.1	39.6	96.0	5 15.8	40.5	96.1	5 09.4	41.3	96.2	5 02.8	42.0	96.3	4 56.2	42.7	96.4	1
2	5 03.3	37.3	96.5	4 56.5	38.2	96.6	4 49.5	38.9	96.7	4 42.5	39.7	96.8	4 35.3	40.4	96.9	4 28.1	41.2	97.0	4 20.9	42.0	97.0	4 13.5	42.7	97.1	2
3	4 26.0	37.4	97.3	4 18.3	38.2	97.4	4 10.6	39.0	97.5	4 02.8	39.8	97.5	3 54.9	40.6	97.6	3 46.9	41.3	97.7	3 38.9	42.1	97.7	3 30.8	42.8	97.8	3
4	3 48.6	37.4	98.1	3 40.1	38.2	98.2	3 31.6	39.0	98.2	3 23.0	39.8	98.3	3 14.3	40.5	98.3	3 05.6	41.3	98.4	2 56.8	42.0	98.4	2 48.0	42.8	98.5	4
5	3 11.2	37.4	98.9	3 01.9	38.2	98.9	2 52.6	39.0	99.0	2 43.2	39.8	99.0	2 33.8	40.6	99.1	2 24.3	41.4	99.1	2 14.8	42.1	99.2	2 05.2	42.8	99.2	5
6	2 33.8	37.5	99.7	2 23.7	38.3	99.7	2 13.6	39.1	99.7	2 03.4	39.9	99.8	1 53.2	40.6	99.8	1 42.9	41.3	99.8	1 32.7	42.1	99.9	1 22.4	42.9	99.9	6
7	1 56.3	37.5	100.4	1 45.4	38.3	100.5	1 34.5	39.1	100.5	1 23.5	39.8	100.5	1 12.6	40.6	100.5	1 01.6	41.4	100.6	0 50.6	42.1	100.6	0 39.5	42.8	100.6	7
8	1 18.8	37.5	101.2	1 07.1	38.3	101.2	0 55.4	39.1	101.3	0 43.7	39.9	101.3	0 32.0	40.7	101.3	0 20.2	41.4	101.3	0 08.5	42.2	101.3	0 03.3	42.8	101.3	8
9	0 41.3	37.5	102.0	0 28.8	38.3	102.0	0 16.3	39.1	102.0	0 03.8	39.8	102.0	0 08.7	40.6	78.0	0 21.2	41.3	78.0	0 33.7	42.1	78.0	0 46.1	42.9	78.0	9
10	0 03.8	37.4	102.8	0 09.5	38.3	77.2	0 22.8	39.1	77.2	0 36.0	39.9	77.2	0 49.3	40.6	77.2	1 02.5	41.4	77.3	1 15.8	42.0	77.3	1 29.0	42.8	77.3	10
11	0 33.8	37.5	76.4	0 47.8	38.3	76.5	1 01.9	39.0	76.5	1 15.9	39.8	76.5	1 29.9	40.6	76.5	1 43.9	41.3	76.5	1 57.8	42.1	76.6	2 11.8	42.8	76.6	11
12	1 11.3	37.5	75.7	1 26.1	38.3	75.7	1 40.9	39.1	75.7	1 55.7	39.9	75.7	2 10.5	40.6	75.8	2 25.2	41.4	75.8	2 39.9	42.1	75.9	2 54.6	42.7	75.9	12
13	1 48.8	37.5	74.9	2 04.4	38.3	74.9	2 20.0	39.0	74.9	2 35.6	39.8	75.0	2 51.1	40.5	75.0	3 06.6	41.2	75.1	3 22.0	42.0	75.1	3 37.3	42.8	75.2	13
14	2 26.3	37.4	74.1	2 42.7	38.2	74.1	2 59.0	39.0	74.2	3 15.4	39.7	74.2	3 31.6	40.6	74.3	3 47.8	41.3	74.4	4 04.0	42.0	74.4	4 20.1	42.7	74.5	14
15	3 03.7	37.4	73.3	3 20.9	38.2	73.4	3 38.0	39.0	73.4	3 55.1	39.8	73.5	4 12.2	40.4	73.6	4 29.1	41.2	73.6	4 46.0	41.9	73.7	5 02.8	42.6	73.8	15
16	3 41.1	37.4	72.5	3 59.1	38.2	72.6	4 17.0	38.9	72.7	4 34.9	39.6	72.7	4 52.6	40.4	72.8	5 10.3	41.2	72.9	5 27.9	41.9	73.0	5 45.4	42.6	73.1	16
17	4 18.5	37.3	71.7	4 37.3	38.1	71.8	4 55.9	38.9	71.9	5 14.5	39.7	72.0	5 33.0	40.4	72.1	5 51.5	41.1	72.2	6 09.8	41.8	72.3	6 28.0	42.5	72.4	17
18	4 55.8	37.3	71.0	5 15.4	38.0	71.0	5 34.8	38.8	71.1	5 54.2	39.5	71.2	6 13.4	40.3	71.3	6 32.6	41.0	71.4	6 51.6	41.8	71.5	7 10.5	42.5	71.7	18
19	5 33.1	37.2	70.2	5 53.4	38.0	70.3	6 13.6	38.8	70.4	6 33.7	39.5	70.5	6 53.7	40.3	70.6	7 13.6	41.0	70.7	7 33.4	41.7	70.8	7 53.0	42.4	71.0	19
20	6 10.3	37.2	69.4	6 31.4	37.9	69.5	6 52.4	38.6	69.6	7 13.2	39.4	69.7	7 34.0	40.1	69.8	7 54.6	40.9	70.0	8 15.1	41.6	70.1	8 35.4	42.3	70.2	20
21	6 47.5	37.0	68.6	7 09.3	37.8	68.7	7 31.0	38.6	68.8	7 52.6	39.4	69.0	8 14.1	40.1	69.1	8 35.5	40.8	69.2	8 56.7	41.5	69.4	9 17.7	42.3	69.5	21
22	7 24.5	37.0	67.8	7 47.7	37.8	67.9	8 09.6	38.5	68.1	8 32.0	39.2	68.2	8 54.2	40.0	68.3	9 16.3	40.7	68.5	9 38.2	41.4	68.6	10 00.0	42.1	68.8	22
23	8 01.5	36.9	67.0	8 24.9	37.6	67.1	8 48.1	38.4	67.3	9 11.2	39.2	67.4	9 34.2	39.9	67.6	9 57.0	40.6	67.7	10 19.6	41.4	67.9	10 42.1	42.1	68.1	23
24	8 38.4	36.8	66.2	9 02.5	37.6	66.4	9 26.5	38.3	66.5	9 50.4	39.0	66.7	10 14.1	39.7	66.8	10 37.6	40.5	67.0	11 01.0	41.2	67.2	11 24.2	41.9	67.3	24
25	9 15.2	36.7	65.4	9 40.1	37.4	65.6	10 04.8	38.2	65.7	10 29.4	38.9	65.9	10 53.8	39.7	66.1	11 18.1	40.4	66.2	11 42.2	41.1	66.4	12 06.1	41.8	66.6	25
26	9 51.9	36.5	64.6	10 17.5	37.3	64.8	10 43.0	38.1	64.9	11 08.3	38.9	65.1	11 33.5	39.6	65.3	11 58.5	40.3	65.5	12 23.3	41.0	65.7	12 47.9	41.7	65.9	26
27	10 28.4	36.5	63.8	10 54.8	37.2	64.0	11 21.1	37.9	64.2	11 47.2	38.6	64.3	12 13.1	39.4	64.5	12 38.8	40.1	64.7	13 04.3	40.8	64.9	13 29.6	41.6	65.1	27
28	11 04.9	36.3	63.0	11 32.0	37.1	63.2	11 59.0	37.8	63.4	12 25.8	38.6	63.6	12 52.5	39.1	63.8	13 18.9	40.0	64.0	13 45.1	40.8	64.2	14 11.2	41.4	64.4	28
29	11 41.2	36.2	62.2	12 09.1	36.9	62.4	12 36.8	37.7	62.6	13 04.4	38.4	62.8	13 31.8	39.1	63.0	13 58.9	39.9	63.2	14 25.9	40.5	63.4	14 52.6	41.3	63.7	29
30	12 17.4	36.0	61.4	12 46.0	36.8	61.6	13 14.5	37.5	61.8	13 42.8	38.3	62.0	14 10.9	39.0	62.2	14 38.8	39.7	62.4	15 06.4	40.5	62.7	15 33.9	41.1	62.9	30
31	12 53.4	35.9	60.5	13 22.8	36.6	60.8	13 52.0	37.4	61.0	14 21.1	38.1	61.2	14 49.9	38.8	61.4	15 18.5	39.5	61.6	15 46.9	40.2	61.9	16 15.0	41.0	62.1	31
32	13 29.3	35.7	59.7	13 59.4	36.5	59.9	14 29.4	37.2	60.2	14 59.2	37.9	60.4	15 28.7	38.7	60.6	15 58.0	39.4	60.9	16 27.1	40.1	61.1	16 56.0	40.8	61.4	32
33	14 05.0	35.6	58.9	14 35.9	36.3	59.1	15 06.6	37.0	59.3	15 37.1	37.7	59.6	16 07.4	38.4	59.8	16 37.4	39.2	60.1	17 07.2	39.6	60.3	17 36.8	40.6	60.8	33
34	14 40.6	35.3	58.1	15 12.2	36.1	58.3	15 43.6	36.9	58.5	16 14.8	37.6	58.8	16 45.8	38.3	59.0	17 16.6	39.0	59.3	17 47.1	39.7	59.6	18 17.4	40.4	59.6	34
35	15 15.9	35.2	57.2	15 48.3	35.9	57.5	16 20.5	36.8	57.7	16 52.4	37.4	58.0	17 24.1	38.1	58.2	17 55.6	38.8	58.5	18 26.8	39.6	58.8	18 57.8	40.2	59.1	35
36	15 51.1	35.0	56.4	16 24.2	35.7	56.6	16 57.1	36.6	56.9	17 29.8	37.2	57.1	18 02.2	37.9	57.4	18 34.4	38.6	57.7	19 06.4	39.3	58.0	19 38.0	40.1	58.3	36
37	16 26.1	34.8	55.5	16 59.9	35.5	55.8	17 33.6	36.2	56.0	18 07.0	37.0	56.3	18 40.1	37.7	56.6	19 13.0	38.4	56.9	19 45.7	39.1	57.2	20 18.1	39.8	57.5	37
38	17 00.9	34.6	54.7	17 35.5	35.3	54.9	18 09.8	36.0	55.2	18 43.9	36.8	55.5	19 17.8	37.4	55.8	19 51.4	38.2	56.1	20 24.8	38.9	56.4	20 57.9	39.6	56.7	38
39	17 35.5	34.3	53.8	18 10.8	35.0	54.1	18 45.8	35.8	54.4	19 20.7	36.5	54.6	19 55.2	37.1	54.9	20 29.6	37.9	55.2	21 03.7	38.6	55.6	21 37.5	39.3	55.9	39
40	18 09.8	34.1	53.0	18 45.8	34.9	53.2	19 21.6	35.6	53.5	19 57.2	36.2	53.8	20 32.5	36.9	54.1	21 07.5	37.7	54.4	21 42.3	38.4	54.7	22 16.8	39.1	55.1	40
41	18 43.9	33.9	52.1	19 20.7	34.5	52.4	19 57.2	35.2	52.7	20 33.4	36.0	53.0	21 09.4	36.8	53.3	21 45.2	37.4	53.6	22 20.7	38.1	53.9	22 55.9	38.8	54.2	41
42	19 17.8	33.8	51.2	19 55.2	34.4	51.5	20 32.5	35.0	51.8	21 03.4	35.8	52.1	21 46.2	36.4	52.4	22 22.6	37.2	52.7	22 58.8	37.9	53.1	23 34.7	38.6	53.4	42
43	19 51.4	33.6	50.4	20 29.6	34.1	50.6	21 07.5	34.8	50.9	21 45.2	35.5	51.2	22 22.6	36.1	51.6	22 59.8	36.9	51.9	23 36.7	37.6	52.2	24 13.3	38.3	52.6	43
44	20 24.8	33.4	49.5	21 03.7	33.8	49.8	21 42.3	34.5	50.1	22 20.7	35.2	50.4	22 58.8	35.9	50.7	23 36.7	36.6	51.0	24 14.3	37.3	51.4	24 51.6	38.0	51.7	44
45	20 57.9	33.2	48.6	21 37.5	33.5	48.9	22 16.8	34.2	49.2	22 55.9	34.9	49.5	23 34.7	35.7	49.8	24 13.3	36.3	50.2	24 51.6	37.0	50.5	25 29.6	37.7	50.9	45
46	21 30.7	32.8	47.7	22 11.0	33.2	48.0	22 51.0	33.9	48.3	23 30.8	34.6	48.6	24 10.4	35.5	49.3	24 49.6	36.0	49.3	25 28.6	36.7	49.6	26 07.3	37.4	50.4	

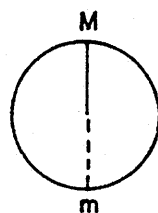
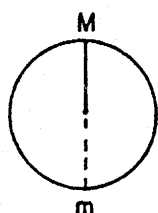
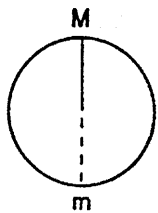

Body

IC			
Dip(Ht )			
Sum			
hs			
ha			
Alt. Corr.			
Add'l.			
H.P.( )			
Corr. to ha			
Ho (Obs Alt)			
Date			
DR Lat			
DR Long			
Obs. Time			
WE(S+,F-)			
ZT			
ZD(W+,E-)			
GMT			
Date (GMT)			
Tab GHA	v		
GHA incr'mt.			
SHA or v Corr.			
GHA			
+ 360 if needed			
a λ (-W,+E)			
LHA			
Tab Dec	d		
d Corr. (+ or -)			
True Dec			
a Lat (N or S)			
Dec Inc (+)d			
Hc (Tab.Alt.)			
tens	DS Diff.		
units	DS Corr.		
Tot. Corr.(+ or -)			
Hc (Comp. Alt.)			
Ho (Obs. Alt.)			
a (Intercept)			
Z			
Zn (°T)			

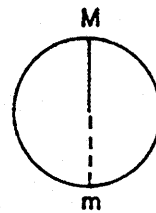
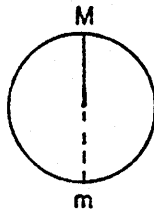
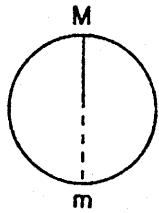

Body			
IC			
Dip(Ht )			
Sum			
hs			
ha			
Alt. Corr.			
Add'l.			
H.P.( )			
Corr. to ha			
Ho (Obs Alt)			
Date			
DR Lat			
DR Long			
Obs. Time			
WE(S+,F-)			
ZI			
ZD(W+,E-)			
GMT			
Date (GMT)			
Tab GHA	v		
GHA incr'mt.			
SHA or v Corr.			
GHA			
+ - 360 if needed			
a $\lambda$ (-W, +E)			
LHA			
Tab Dec	d		
d Corr. (+ or -)			
True Dec			
a Lat (N or S)			
Dec Inc (+)d			
Hc (Tab. Alt.)			
tens	DS Diff.		
units	DS Corr.		
Tot. Corr. (+ or -)			
Hc (Comp. Alt.)			
Ho (Obs. Alt.)			
a (Intercept)			
Z			
Zn ( $^{\circ}$ T)			

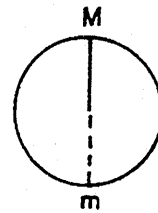
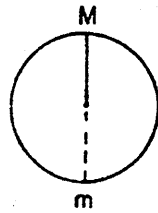
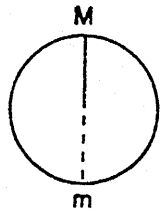

Body				
IC				
Dip(Ht )				
Sun				
hs				
ha				
Alt. Corr.				
Add'l.				
H.P.( )				
Corr. to ha				
Ho (Obs Alt)				
Date				
DR Lat				
DR Long				
Obs. Time				
WE(S+,F-)				
ZT				
ZD(W+,E-)				
GMT				
Date (GMT)				
Tab GHA	v			
GHA incr'mt.				
SHA or v Corr.				
GHA				
+ 360 if needed				
a λ (-W,+E)				
LHA				
Tab Dec	d			
d Corr. (+ or -)				
True Dec				
a Lat (N or S)				
Dec Inc (+)d				
Hc (Tab.Alt.)				
tens	DS Diff.			
units	DS Corr.			
Tot. Corr.(+ or -)				
Hc (Comp. Alt.)				
Ho (Obs. Alt.)				
a (Intercept)				
Z				
Zn (°T)				