REPORT No. 198

**ASTRONOMICAL METHODS IN AERIAL
NAVIGATION**

By K. HILDING BEIJ
Bureau of Standards

CONTENTS

	Page
I. Summary.....	273
II. Introduction.....	273
III. Theory.....	275
IV. Altitudes.....	278
Natural horizons.....	278
Artificial horizons.....	278
Sextants.....	280
Sextants for use with natural horizons (Marine type, Baker, Douglas-Appleyard).....	280
Bubble sextants (Marcuse, Hartmann, Lindt, Byrd, Willson, Schwarzschild, R. A. E.).....	281
Pendulum sextants (Fischer).....	286
Gyroscopic sextants (Fleuriais, Derrien).....	288
Correction of observed altitudes.....	290
Index correction.....	290
Dip.....	290
Refraction.....	291
Parallax.....	291
Semidiameter.....	291
Altitude observations that have been made on board aircraft.....	922
V. Azimuths.....	293
VI. Time (Sternzeit-transformator).....	294
VII. The Nautical Almanac.....	295
VIII. The reduction of observations.....	295
Methods.....	295
1. Logarithmic solutions (formulas, precomputation).....	296
2. Tabular solutions (H. O. No. 201, Ball altitude tables, H. O. No. 203, de Aquino tables, two-star tables, latitude from Polaris).....	297
3. Solutions by means of nomograms and diagrams (D'Ocagne nomogram, Favé diagram, Littlehales diagram, Veater diagram, two-star diagram, Leick diagram).....	299
4. Graphical solutions (Baker navigating machine, Favé method, Brill method, Voigt instrument, toposcope, Littlehales methods).....	304
5. Mechanical solutions (Line-of-position computer, Bygrave slide rule).....	308
The reduction of observations on board aircraft.....	310
IX. Maps and accessories (route maps, general maps, plotting board and map case).....	311
X. Utility and application of the astronomical method.....	312
XI. Bibliography.....	315

ILLUSTRATIONS

	Page
FIGURE 1. The astronomical triangle.....	276
2. Circles of equal altitude.....	276
3. Baker aircraft sextant.....	280
4. Marcuse (Butenschön) sextant.....	281
5. Hartmann sextant.....	281
6. Lindt sextant.....	282
7. Byrd sextant.....	282
8. Willson sextant.....	283
9. Schwarzschild sextant.....	284
10. R. A. E. sextant, side view.....	285
11. R. A. E. sextant, end view.....	285
12. R. A. E. sextant, diagram.....	286
13. Fischer sextant.....	287
14. Fischer pendulum horizon.....	287
15. Fleuriqis sextant.....	288
16. Derrien sextant.....	289
17. Sternzeit-transformator.....	294
18. Astronomical triangle—notation.....	296
19. Divided astronomical triangle—notation.....	296
20. D'Ocagne nomogram.....	399
21. Favé diagram.....	301
22. Two-star diagram.....	302
23. Leick diagram.....	303
24. Baker navigating machine.....	304
25. Favé chart.....	306
26. Favé nomogram.....	306
27. The Brill instrument.....	306
28. The Voigt ("Orion") instrument.....	308
29. Line-of-position computer.....	309
30. Bygrave slide-rule.....	310

REPORT No. 198

ASTRONOMICAL METHODS IN AERIAL NAVIGATION

By K. HILDING BEIJ

I. SUMMARY

This report was prepared by the Aeronautic Instruments Section of the Bureau of Standards, at the request of the National Advisory Committee for Aeronautics. A part of the material was made available by the courtesy of the War Department, from the results of investigations carried out at the Bureau of Standards for the Army Air Service.

The astronomical method of determining position is universally used in marine navigation and may also be of service in aerial navigation. The practical application of the method, however, must be modified and adapted to conform to the requirements of aviation. Much of this work of adaptation has already been accomplished, but, being scattered through various technical journals in a number of languages, is not readily available. This report is for the purpose of collecting under one cover such previous work as appears to be of value to the aerial navigator, comparing instruments and methods, indicating the best practice, and suggesting future developments.

The various methods of determining position and their application and value are outlined, and a brief résumé of the theory of the astronomical method is given. Observation instruments are described in detail. A complete discussion of the reduction of observations follows, including a rapid method of finding position from the altitudes of two stars. Maps and map cases are briefly considered. A bibliography of the subject is appended.

II. INTRODUCTION

Navigation is that science or art by means of which ships and aircraft are guided or conducted by the most convenient route from one point to another on the earth's surface. In practice the navigator makes use of a number of different methods which enable him to follow his course and to determine his geographical position from time to time during the progress of the journey. At first navigation consisted simply of piloting; and this method is still used whenever possible. In piloting the course is followed and position is determined by reference to distinctive landmarks, which are usually identified with the aid of a map or chart. When this method fails, the navigator resorts to dead reckoning. This consists in deducing the position at any time, and consequently the course to be pursued, from a record of the direction and rate of travel of the ship or aircraft from the known point of departure. The position as found by dead reckoning is always subject to errors due to the effects of ocean currents and winds and to the inaccuracies of the instruments which measure the speed or indicate direction. Occasionally these errors may be so great that the dead reckoning position is entirely unreliable; and this is especially so in the case of aerial navigation, since frequently the direction and strength of the wind at the altitude of the aircraft are unknown. In such cases, or whenever a check on the dead-reckoning position is desirable, position may be determined by astronomical observations or by radio bearings.

When the first airplanes and airships had demonstrated that flight was practicable, the possibilities of traversing great distances over land or sea by aircraft began to be considered. Marine navigation was already a highly developed science. Its methods, through centuries of use, had been simplified, refined, and well adapted to their purpose. Its instruments for

observation, by numerous inventions and the ever-increasing skill of instrument makers, had been brought to a high state of perfection. Naturally these methods and instruments were borrowed, with but few changes, by the pioneers in aerial navigation. However, it was soon apparent that, while the fundamental principles of marine navigation could be adopted, more or less radical changes were necessary in the practical application of these principles to the navigation of the air.

The navigator is confronted in the air by conditions similar in nature to those encountered at sea, but differing greatly in the effects which they produce. The tides and currents of the seas have been charted with considerable accuracy; the surface winds have been carefully studied, and the general laws governing their behavior have been made known. Thus the mariner can usually make proper allowance for the action of ocean currents and winds, and his dead-reckoning position is seldom greatly in error. Since the speed of ships is relatively small, only occasional checks on the dead reckoning are necessary. Therefore astronomical observations are made only in the daytime when the horizon is visible, and radio bearings are used chiefly near the coast, if at all. On the other hand, the winds of the upper atmosphere are almost unknown and can not be charted as ocean currents are. Furthermore, the speed of the wind may be quite great compared with that of the aircraft and thus may have a very considerable effect. The strength and direction of the wind must be known if the navigator is to make use of dead reckoning. Usually these factors must be determined from the aircraft, and this is a matter of considerable difficulty. Often, at night or when the surface of the earth is obscured by fog or clouds, it is impossible. Dead reckoning, while valuable and necessary, must always be a more or less uncertain method. For this reason, and because of the great speed of aircraft, position must be determined by astronomical or radio methods at frequent intervals both during the night and the day. Fortunately great accuracy is not required. There are no dangerous rocks or shoals to avoid and, even if the objective is missed by a few miles, this will mean but a few minutes of extra flying. In the exceptional case, where the aircraft must arrive exactly at a given point, the radio compass will probably furnish a practical solution of the problem.

Aerial navigation is still in its infancy. Piloting is the only method in everyday use. Dead reckoning is very seldom employed; and astronomical observations or radio bearings have been attempted only in a few isolated cases, and then usually for experimental purposes rather than as practical aids to navigation. This apparent lack of progress is due chiefly to the fact that aviation is not as yet of any real economic importance in the field of transportation and consequently there is no great demand for navigation. Practically all the advance which has been made was accomplished with a view toward developing aircraft as instruments of war. Also there are several outstanding problems which must be solved before aerial navigation in the scientific sense can become possible. For example, a sufficiently accurate means for indicating the vertical is wanting; no really satisfactory ground speed indicator is available; and instruments to aid in landing in fog have not yet been developed.

Aerial transportation on a commercial basis will undoubtedly become general within the near future. It is important, therefore, that as much as possible of the necessary development work be accomplished so that when the demand comes suitable methods and instruments for navigating will be available. In the application of the general principles of navigation, certain demands must be fulfilled. The methods must be simple and direct, requiring a minimum expenditure of time and labor. All instruments must be simple in design, rugged in construction, and convenient in operation. Although the accuracy of marine navigation need not be approached, results must be reliable within the limits of error which may be adopted.

Since dead reckoning is very uncertain, often failing entirely, other methods for determining position are of far more importance than in marine navigation. For short trips over familiar country which has been well mapped great reliance can be placed on piloting. On long flights over the sea or over land deficient in distinctive landmarks or obscured by fog or clouds, and territories relatively unknown which are mapped either poorly or not at all, piloting is impossible. Gyroscopic apparatus to indicate latitude and longitude has been suggested, but because

of almost insuperable mechanical difficulties, no satisfactory instrument has as yet been constructed. Position may be found by measurements of the strength and direction of the earth's magnetic field.¹ The method, however, is of little value in that it presents considerable instrumental difficulties and the results obtained are not sufficiently accurate. Astronomical position determination as practiced at sea and the recent method of radio bearings seem to be the only practical methods.

At present the radio direction finder appears to be the more promising. However, the method is subject to errors which may arise from distortion due to the electrical system and the metallic parts of the ship, from possible deviations of the electromagnetic waves from their theoretical great circle paths,² and from disturbances due to static and strays. This method is also limited considerably in practice, for if it is to be used to any great extent it must be possible for any aircraft to get in touch with at least two ground stations at frequent intervals. This requires a rather large number of sending stations scattered over the earth, with a personnel on continuous duty. While this may be possible in the future, at present it is not the fact, and therefore it is only under very limited conditions, both as to time and place, that a radio fix can be obtained.

Thus there is a considerable field for the astronomical method. When there are no radio sending stations in range, or in time of war when it might be impossible to rely on the radio direction finder, the astronomical method is the only one possible. Furthermore, it may be used to check the results of the radio or to enable the navigator to get a complete fix when only one sending station is in range, by combining the radio position line with an astronomical position line. Also it may supplement the radio direction finder in case the aircraft's receiving set should get out of order.

For the purposes of air navigation the astronomical method offers further advantages. Its theory and practice have been studied by mariners for many years and have been reduced to a science. While in many cases radical departures are necessary, much of the material, such as tables and maps, is available for immediate use, or requires only slight modification or simplification. The method may be used by day or by night, whenever the heavens are visible. Its practical application is simple, and results can be obtained in a very few minutes. The limitations of the method restrict its use to some extent, but otherwise do not reduce its value. Elevated clouds, when covering the greater part of the sky, will, of course, preclude any observations. A more serious defect lies in the fact that in general only the sun is visible during the daytime and a complete determination of position can not be made. Instrumental difficulties, such as that presented by the artificial horizon, are considerable; but it is reasonable to suppose that these limitations will be removed in the near future.

III. THEORY

A brief outline only of the theory of determining position by astronomical observations will be given here. For a detailed exposition of the subject any standard reference or text book on navigation may be consulted.

The earth's surface and the heavens may be considered as two concentric spherical surfaces rotating with respect to each other, the heavens being at an infinite distance from the center. The relative position of the earth and heavens is determined by the time of day and the day of the year. The axis of rotation, passing through the earth's poles, meets the celestial sphere at the celestial poles; and the plane of the earth's equator intersects the celestial sphere in the celestial equator. Planes passing through the poles intersect the spheres in great circles, which are called meridians. Similarly planes parallel to the equatorial plane determine small circles, known as parallels.

The location of any point on the earth's surface is specified by the coordinates of latitude and longitude. Latitude is the angular distance north or south of the Equator measured on a

¹ Illustrierte Aeronautische Mitteilungen, Vol. XIII, No. 22, Nov. 3, 1909. "Magnetische Ortsbestimmung im Ballon," by Doctor Bidlingmaier.

² Bureau of Standards Scientific Paper No. 353. "Variation in Direction of Propagation of Long Electro-Magnetic Waves," by Lieut. Commander A. Hoyt Taylor, U. S. N. R. F.

meridian in angular units from zero at the Equator to 90° at the poles. North latitudes are reckoned as positive and south latitudes negative. Longitude is the angular distance along the Equator east or west of an arbitrary meridian measured in angular units or units of time from zero to 180° or zero to 12 hours, and positive or negative according to whether it is west or east. The arbitrary meridian commonly used is that of Greenwich. Longitudes may also be measured by the angles at the poles between the meridians, the zero meridian being that of Greenwich.

Several systems of coordinates are used in locating stars on the celestial sphere. In one system declination and right ascension are used, declinations on the celestial sphere being measured exactly as latitudes are measured on the earth. Right ascension corresponds to longitude but is measured eastward from an arbitrary zero, the first point of Aries, through the full circle of 360° , or 24 hours. If the prime meridian be taken as passing through the observer's zenith, right ascension is replaced by hour angle and a second system is obtained in which the coordinates are declination and hour angle. Again we may substitute the observer's zenith and nadir for the poles and his horizon for the equator, thus obtaining the coordinates of altitude and azimuth, respectively. Other systems are also employed but are not important for the purposes of navigation. It will be noticed that of the coordinate systems mentioned, the first

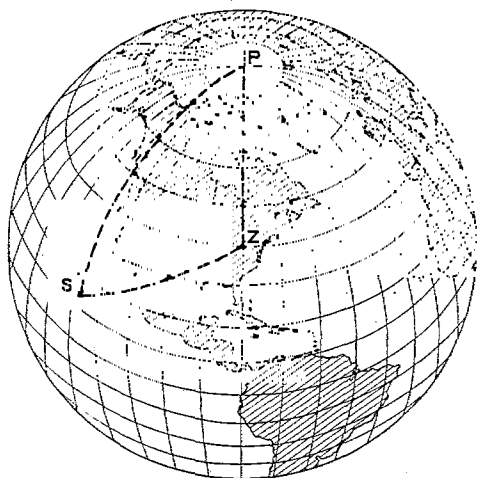

FIG. 1.—The astronomical triangle

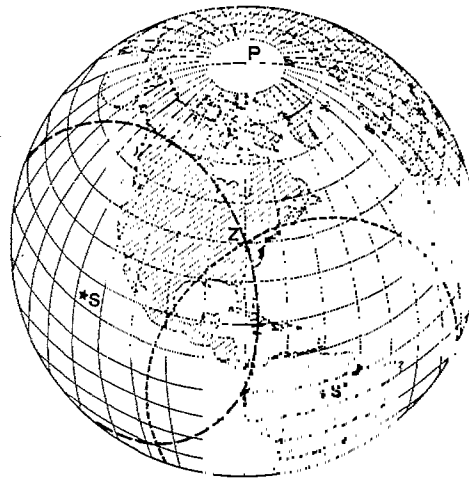

FIG. 2.—Circles of equal altitude

is entirely independent of the position of the observer, while the second is partly and the third wholly dependent on his position.

A straight line from any star to the center of the earth will meet the earth's surface in a point called the geographical position of the star. If the star's declination and right ascension and the time are known, this substellar point can be located in terms of latitude and longitude. The problem of the navigator consists in finding his geographical coordinates by locating himself with reference to the geographical position of one or more stars.

In Figure 1, which is a representation of a portion of the earth's surface, P is the pole, Z is the position of the observer, and S is the geographical position of the star. These points form the vertices of a spherical triangle ZPS which is known as the "astronomical triangle." It is evident by inspection that in this triangle the side PS is equal to the co-declination, or polar distance, of the star. Similarly ZS is the co-altitude, or zenith distance, of the star, and PZ is the co-latitude of the observer. The angle at P is the hour angle, and the angle at Z is the azimuth of the star. The angle at S is called the parallactic or position angle.

If the navigator can solve this astronomical triangle, he will be able to find his latitude and longitude. He must determine the side PZ, from which is derived the latitude, and the hour angle P, which combined with the right ascension of the star will give the longitude. Since the time is known, the right ascension and declination of the star may be found from the Nautical Almanac, and thus the side PS is determined. Then, if the altitude and azimuth of the star

can be measured, two sides and an angle of the triangle will be known, from which the desired parts can be computed.

The altitude (or zenith distance) is readily measured, but so far no practical means have been devised whereby the azimuth may be observed with the required accuracy. Since the altitude alone does not give sufficient data for the solution of the astronomical triangle, the latitude and longitude of the observer can not be determined directly. It is possible, however, to lay down a line on the chart on which his position must be. If the altitudes of two stars can be observed simultaneously, or nearly so, two such lines can be found and their point of intersection will be the observer's position. This method, discovered by Sumner and later simplified by Marcq St. Hilaire, is universally used in the practice of navigation at sea.

Referring to Figure 2, S is the geographical position of a star at a given time. If the observer were at S, at this instant of time he would see the star in his zenith. Since for all practical purposes the star is at an infinite distance, an observer at an angular distance SZ from S would see the star at an angular distance SZ from his zenith. The loci of points equidistant from S, which are likewise the loci of the points at which the star appears at the same zenith distance (or altitude), are circles which are known as circles of equal altitude. Having measured the altitude of a star and knowing its geographical position, the navigator can find the circle of equal altitude upon whose circumference he must be situated. From the simultaneous observation of a second star, he can determine a second circle which also passes through his position. The intersection of the two is his position. While in general there are two intersections, one of these can be eliminated, since the navigator always has an approximate location of his position.

In practice, the approximate position being known, it is never necessary to determine the whole of a circle of equal altitude. As the radius of the circle is usually very large, the small arc required may be replaced by a straight line without appreciable error. This line is called a line of position or the Sumner line. The three common methods for finding the Sumner line are known as the chord, the tangent, and the Marcq St. Hilaire methods.

By the chord method two values of the latitude (or longitude) are assumed. The astronomical triangle is then solved for the corresponding longitudes (or latitudes). In this way two points are determined, and the line joining them is the required Sumner line.

In applying the tangent method, a single latitude (or longitude) is assumed and the corresponding longitude (or latitude) and also the azimuth are computed. A line perpendicular to the azimuth through the point thus determined is the Sumner line.

The Marcq St. Hilaire method is more general than either of the foregoing and has almost entirely superseded them. In using this method, a position, generally that found by dead reckoning, is assumed. The altitude and azimuth of the star as they would have been at this position at the instant of observation are computed. The assumed position is laid down on the map and a line drawn through this point in the direction of the computed azimuth. The Sumner line is perpendicular to this line and at a distance in nautical miles equal to the difference between observed and computed altitudes (in minutes of arc) from the assumed point. This distance is laid off toward or away from the substellar point according as the observed altitude is greater or less than the computed altitude.

Theoretically it is possible to determine position lines in various other ways. From the azimuth of a star a line of equal azimuth may be found, but since the azimuth can not be measured with sufficient accuracy, this is of little value to the navigator. It would be comparatively simple to measure the difference in azimuth between two stars. This method is impracticable because of the difficulties presented in the computation of the position line. Furthermore, the altitudes of the same two stars will give a complete determination of position. Similar considerations apply to the case of finding a position line by determining the time when two stars have the same azimuth or, in other words, when they are on the same vertical.

It has been suggested that local sidereal time and latitude might be obtained directly by an instrument for observing any two stars simultaneously. Suppose a telescope to be set parallel

to the earth's axis. Its angle of elevation will then be a measure of the latitude. Any plane perpendicular to the telescope axis will be parallel to the plane of the earth's equator. Considered astronomically the axis of the telescope may be taken as coincident with the earth's axis, and the perpendicular plane as coincident with the equatorial plane. Images of any two stars above the horizon may be reflected into the telescope and brought into coincidence by two mirrors properly oriented. The angular position of the mirrors with respect to the telescope axis will then depend only on the declinations of the stars. Also their angular positions in the equatorial plane will depend on the right ascensions of the stars and the local sidereal time. It is possible to construct an instrument of this nature, but, unfortunately, the difficulties of observation are so great that the instrument is of no practical value.

IV. ALTITUDES

The altitude of a celestial body is its angular elevation measured from the observer's horizon toward his zenith. Therefore, in order to find the altitude of a star, the navigator requires some means for indicating his horizon. Obviously it makes no difference whether a horizontal plane or the direction of the vertical is determined. The reference line or plane may be furnished by a natural or an artificial horizon.

NATURAL HORIZONS

The level surface of the sea affords a very convenient and accurate natural reference plane which is used universally by marine navigators in the observation of altitudes. Provided that it is clearly visible, the sea horizon may also be used on board aircraft; and observations can be made easily and with practically the same accuracy as at sea.³ The level land of some coastal plains, river valleys, and deserts provides an even more convenient horizon, as the contrast is greater and the line of the horizon is more sharply defined. It is evident, however, that the natural horizon formed by land or sea is not always available; the surface of the land may be too rugged, or fog or clouds may obscure the view. At night it will never be visible. Furthermore, it has been found that the horizon can seldom be distinguished clearly from any altitude at which aircraft are likely to travel. The surface of the land or sea is almost always covered with a layer of haze. At 20 feet above the level of the sea, the horizon is less than 5 nautical miles distant and the haze is not sufficiently dense to affect its visibility. The distance of the horizon increases as the elevation of the observer increases. At 1,000 feet it is over 33 miles, at 5,000 feet about 75 miles, and at 10,000 feet it is more than 100 nautical miles away. Consequently, as the aviator ascends, the horizon becomes more and more indistinct until, at an altitude varying according to the state of the atmosphere, but generally about 2,000 or 3,000 feet, it is entirely obscured.

With a further increase in altitude a horizon often reappears. This horizon is in reality formed by the upper surface of the layer of haze. Under favorable conditions it is very distinct, practically level, and may be employed in the observation of altitudes. Also the upper surfaces of cloud or fog strata may sometimes be so level and unbroken as to form a distinct horizon line. These cloud or haze horizons are, in general, not reliable enough for the purposes of aerial navigation. Their availability depends on atmospheric conditions, and at night, of course, they can not be used at all. The navigator has no means of knowing whether they are truly horizontal, and usually he can not accurately determine his elevation above the horizon and thus be certain of his dip correction.

ARTIFICIAL HORIZONS

The fact that the natural horizon is visible only during the daytime, and then only when the weather is clear, suggested the idea of obtaining a true vertical or horizontal reference line by instrumental means. Attempts at constructing an artificial horizon for the sextant had been made ever since Hadley's invention of the instrument, but the problem became invested

³ Proc. Astronomical Society of the Pacific, June, 1919, Vol. 31, No. 181. "Report on the navigation of aircraft by sextant observations," by H. N. Russell.

with a new significance when navigation of the air became possible. If the astronomical method of position finding is to attain its maximum usefulness and value in aerial navigation, an accurate and dependable artificial horizon is essential. For this reason, and because bomb sights and various other instruments also require a true vertical reference line, the problem of the artificial horizon is one of great importance.

The direction of the vertical at any point on the earth's surface is defined as the direction of a plumb line at that point. This direction can be determined only by recourse to the force of gravity; but a number of different methods may be employed. The free surface of a liquid at rest is a true level surface (perpendicular to the vertical at every point) and is used in the case of the sea horizon and the mercury artificial horizon; liquid levels of various kinds are common, as, for example, the bubble tube and the ball level; the plumb bob or pendulum may be employed in a variety of forms; and, finally, the gravity-controlled gyroscope or spinning top furnishes a means for finding the vertical which may eventually replace all others on board ships or aircraft.

All of the devices enumerated above may be used on a fixed base with an accuracy limited only by the care taken in construction and operation. On board moving ships or aircraft, however, great difficulties are encountered. Errors are caused by vibration, pitching, rolling, and yawing of the ship. Linear and angular accelerations due to changes in speed and to turns result in very large errors, and so far no satisfactory manner of eliminating these errors has been devised. The effects of vibration are easily removed by a suitable mounting if the instrument is attached to the ship. No special precautions need be taken in the case of hand instruments, since the body of the observer will absorb the vibration. Pitching, rolling, and yawing oscillations are more troublesome and in the case of bubbles and short-period pendulums may give rise to considerable errors. However, the period of these oscillations is usually fairly small (30 seconds or less), and by giving the artificial horizon a long period, which may most readily be done in the case of the gyroscope, the resulting errors can be reduced to a value small enough to be neglected in practice.

When the point of suspension of a pendulum is subject to an acceleration, linear or angular, the forces of inertia come into play and, in combination with the force of gravity, cause the direction of the center of gravity with respect to the point of suspension to vary. If the acceleration be uniform, the pendulum assumes an equilibrium position which is the resultant of the acceleration and gravity forces, the result being the same as if the direction (and intensity) of the force of gravity changed. This new direction is called the apparent vertical. Short-period pendulums and bubble levels indicate the apparent vertical. If the acceleration persists for a short time only and is followed by an acceleration in the opposite sense, a pendulum of very long period, or a gyroscope, will not have time to assume the new equilibrium position, and the effects of the second acceleration will tend to destroy those of the first. Such an arrangement thus indicates the true vertical more or less approximately.

The bubble level is the simplest form of artificial horizon and the most convenient as far as sextants are concerned; but it can not be used with any degree of success unless precautions are taken to reduce the acceleration errors. This may be done by flying as nearly as practicable at a uniform speed with no turns. Also no reliance should be placed on a single reading, but the average of five or six should be used. Pendulum horizons are usually damped and of short period, and the same precautions are necessary.

Artificial horizons for sextants may be constructed as separate instruments mounted on the aircraft or may be combined with the sextant itself. Russell, in his tests at Langley Field,⁴ employed the former. His instrument consisted of a pendulum, about 10 inches in length, mounted in gimbals within a cylindrical case. Glycerin was used as a damping fluid. At the top of the pendulum was mounted a reflecting surface, and the instrument was used in the same manner as the ordinary mercury horizon, the angle between the star and its image in the mirror being measured. This method is inconvenient, however, since the position of the horizon in the aircraft must be changed for different observations. It is therefore advisable

⁴ H. N. Russell, loc. cit.

to combine the horizon with the sextant into one instrument. Various forms of artificial horizons will be described in connection with the sextants on which they are used.

SEXTANTS

The term "sextant" is here used to include all instruments which are intended for the measurement of altitudes, regardless of the form of the instrument or the optical principle upon which it is based. In general, only sextants which are available at the present time are described. One or two instruments are mentioned, however, either because they are convenient illustrations of certain types or because they incorporate some novel features which may prove to be useful.

NATURAL HORIZON SEXTANTS

The theory, construction, and operation of the marine sextant are so well known that it is unnecessary to describe the instrument here. If the marine sextant is to be used on board aircraft, it is desirable that it be rather small and light in weight. The angular field of view included in the index glass should be as large as possible, and the telescope should be of low power and large field. It may be advisable when the visibility is poor to dispense with a telescope and observe with the naked eye. The arc should be clearly graduated with rather heavy lines and large figures. A tangent micrometer screw with a drum indicating minutes of arc and a simple, easily operated clamp are preferable to the usual vernier with its clamping and slow-motion screws. The adjustment of the instrument should be checked at frequent intervals.

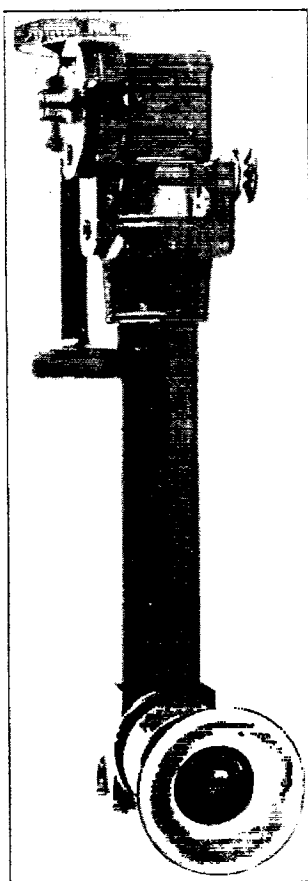

FIG. 3.—Baker aircraft sextant

The Baker aircraft sextant, an English instrument, is shown in Figure 3. This sextant was designed with a view to eliminating the necessity for making the dip and semidiameter corrections. This object is achieved by bringing into view the horizon in front of and in back of the observer simultaneously, one image being erect and one inverted. The two images are separated by a distance depending on the sum of the dips in each direction. In making an observation the image of the star is set to bisect the space between the horizons and thus the correction for semidiameter is also obviated. The sextant consists of a periscopic telescope. In front of the objective are two fixed prisms, the horizon mirrors, and one rotating prism, the index mirror. The index mirror is turned by means of a worm gear and worm. The worm gear carries a scale reading to tens of degrees, while the worm bears a divided drum graduated in degrees and tenths of degrees. By estimation angles may be read to within one or two minutes. The instrument is simple and convenient.

It is assumed that the dips to the front and back horizons are equal. In the case of cloud or haze horizons this is frequently not the fact, and considerable errors may result. The observer, having no means for judging the accuracy of the horizon, must always regard his position lines as being subject to large errors. If the true sea horizon be used, these considerations do not apply.

The Douglas-Appleyard arcless sextant is an English instrument designed for use in surveying and in aerial navigation. The sextant has the usual index and horizon mirrors and telescope. The index arm and graduated arc of the marine sextant are discarded, and the index mirror is operated by a worm gear and worm. The worm carries a micrometer drum and a counter, the counter showing tens of degrees and the micrometer a graduated scale divided to intervals

of 10 minutes. A small magnifying glass is provided which is mounted in such a way that the instrument may be read without removing the eye from the telescope. Electric illumination is furnished. It is claimed that fair accuracy is obtainable in a very short space of time and that the instrument is well suited for aerial navigation.

BUBBLE SEXTANTS

Figures 4, 5, and 6 show three German bubble sextants of a very simple form. The essential parts of each instrument are a graduated quadrant with a telescope along one radius, an index arm pivoted at the center of the arc, and a bubble tube mounted on the index arm. The bubble tube is so mounted that the bubble in its central position will be exactly over the pivot center. Thus a fixed mirror can be used in the telescope to reflect an image of the bubble to the eyepiece. The bubble image appears foreshortened in all positions but one. This, however, is not serious except near the upper and lower limits of the scale, which are rarely used in practice.

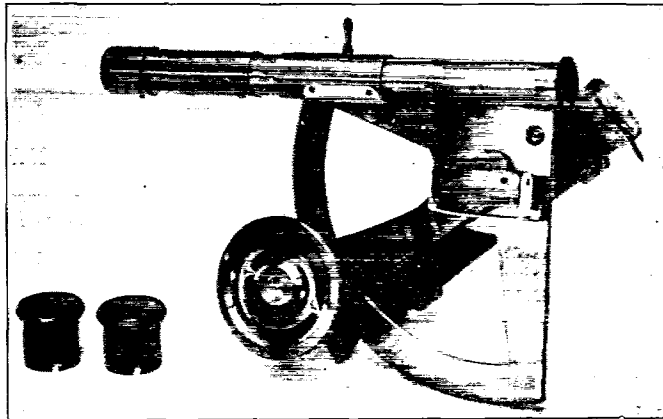

FIG. 4.—Marcuse (Butenschön) sextant

The Marcuse⁵ sextant (fig. 4) manufactured by Butenschön, of Hamburg, is poor in design and construction compared with the other two. The scale is on the back or handle side of the arc and is read by means of a vernier to single minutes. The field of the telescope shows the entire bubble tube and in the center a circular opening about the size of the bubble image, through which the star

or sun may be seen, and also a reticule consisting of three vertical and three horizontal lines.

In making an observation, the telescope is pointed at the star, which is centered by means of the reticule. Then the index arm is adjusted until the bubble image is hidden by the circular opening in the field.

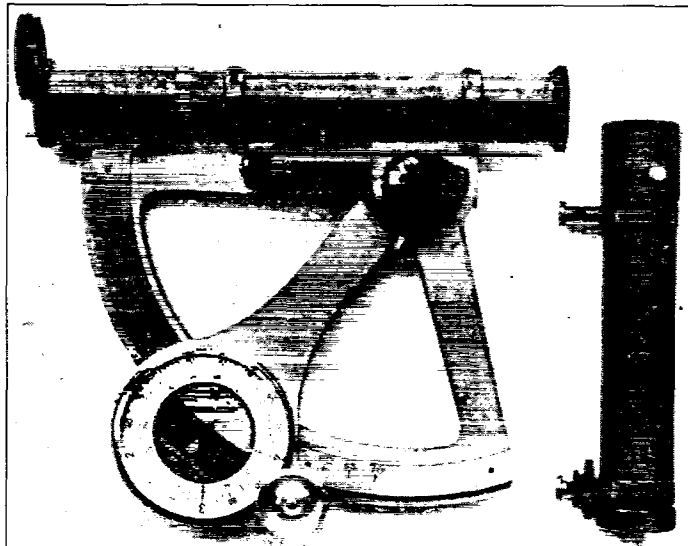

FIG. 5.—Hartmann sextant

The Hartmann sextant⁶ (fig. 5) made by Hartmann and Braun, of Frankfort, incorporates several novel features. The bubble tube may be used in either of two positions, one for altitudes and the other for dip angles. The arc and dial carry corresponding sets of numbers, black for altitudes and red for dip angles. The arc is graduated at 5° intervals only. The index arm carries an index for reading the arc and also a pointer geared to a rack on the arc. This pointer travels over a dial

graduated in 5° at 5-minute intervals. A small thumb nut geared to the arc is used to set the index arm. The field in the telescope consists of two parts. One, slightly more than half

⁵ Illustrierte Aeronautische Mitteilungen, Vol. IX, No. 4, 1905.

⁶ Deutsche Luftfahrer Zeitschrift, Vol. XVI, No. 20, Oct. 2, 1912. "Ein Libellenquadrant in neuer Form," by Doctor Hartmann.

of the total, contains the reticule of one vertical and three horizontal cross hairs, and the other shows the bubble tube. An observation is made exactly as with the Butenschön sextant, except that the bubble must be centered by means of the graduations on the bubble tube.

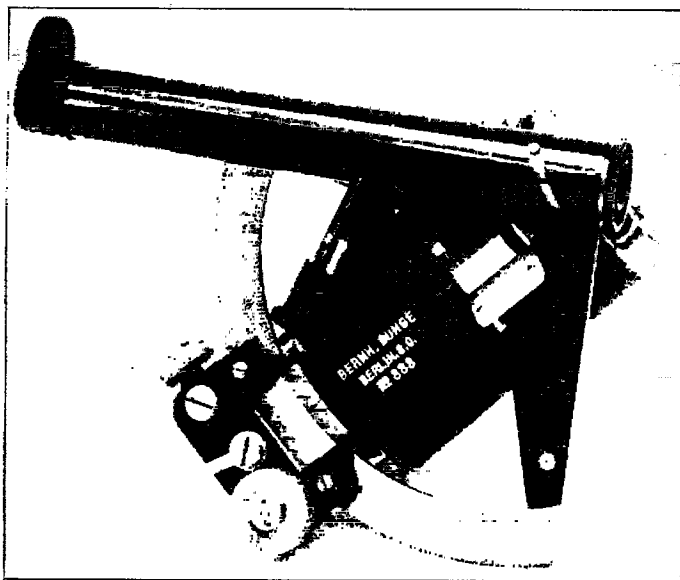

FIG. 6.—Lindt sextant

The Lindt⁷ sextant (fig. 6) is constructed by Bunge, of Berlin. It appears to be the best instrument of the three. The bubble tube is adjustable so that any index error may be corrected. The index arm is set by a screw geared to a worm which meshes in a rack on the arc. The worm carries a drum graduated in minutes of arc, one turn of the drum corresponding to 1° on the arc. A lever may be used to disengage the worm in making rapid approximate settings. Electric illumination of the reticule and bubble is provided, as in the other sextants but in the Lindt instrument the intensity of illumination may be varied by means of a rheostat set in the

handle. This is an essential feature. The telescope field shows a reticule of three horizontal and three vertical lines and at one side an image of the bubble tube. The procedure is similar to that for the Hartmann sextant.

These sextants are very simple instruments, require few adjustments, and are small and light. However, the necessity for pointing the telescope directly at the star may mean that the

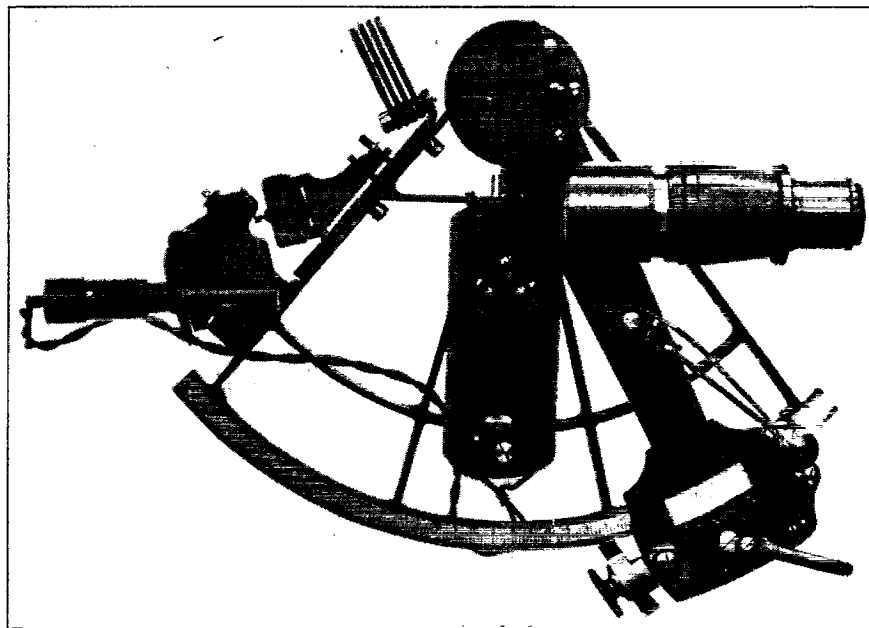

FIG. 7.—Byrd sextant

observer may find himself in an awkward position in which he will have difficulty in keeping the star accurately centered by means of the reticule. The great disadvantage of these instru-

⁷ Deutsche Luftfahrer Zeitschrift, Vol. XVI, No. 11, May 29, 1912. "Ein Libellenquadrant in neuer Form," by W. Lindt.

ments is the necessity for making a double coincidence setting—bubble to bubble tube center, and star to reticule. These sextants can not be used with a natural horizon. The dip and semidiameter corrections are not necessary.

A number of bubble sextants have been devised which consist merely of a marine sextant to which has been added a bubble level. The Byrd sextant (fig. 7), developed by the United States Navy, is an example of this type of instrument. The sextant itself is of the usual marine form except that the vernier has been replaced by a tangent screw with a micrometer drum reading to half minutes, with a release lever for rapid settings. The level bubble is mounted on a bracket, below and in back of the horizon glass. A plane mirror reflects an image of the bubble tube through the clear half of the horizon glass to the telescope, which is provided with an extra lens, semicircular in shape, to bring the bubble tube into focus. Adjusting screws are provided for setting both the bubble tube and the plane mirror. If it is desired to use a natural horizon, the plane mirror may be unclamped and swung downward out of the way. Illumination is provided for the bubble and the scale; the battery and switches are mounted in the handle.

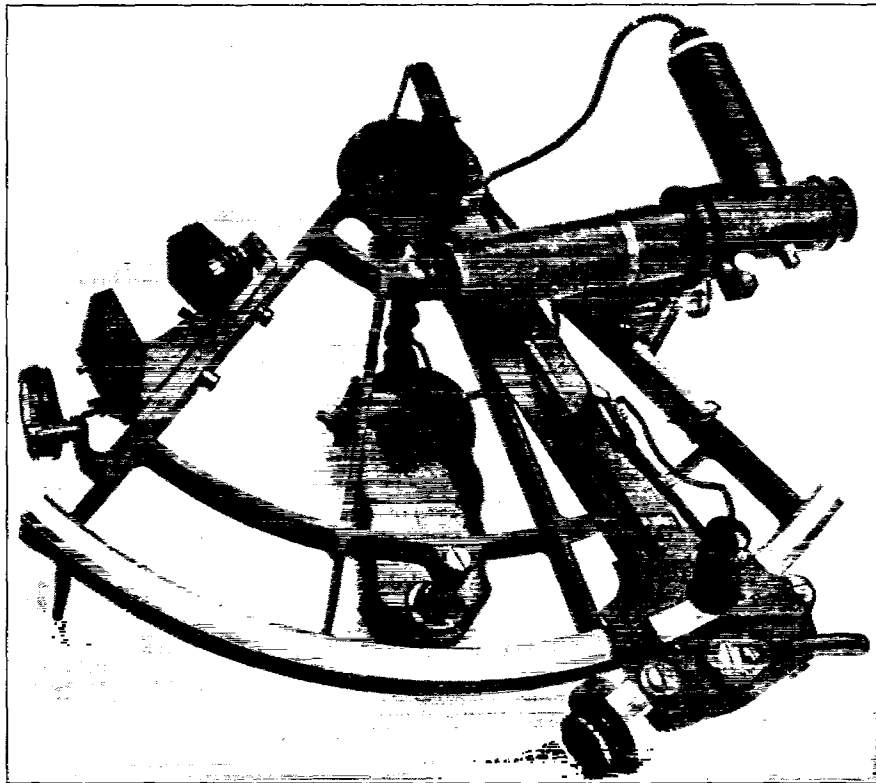

FIG. 8.—Willson sextant

The Willson⁸ sextant was designed by Prof. Robert W. Willson of Harvard. (See fig. 8.) The sextant itself is very much like the Byrd, the only differences being in [the bubble level and telescope. The artificial horizon consists of a circular level mounted in a short tube fixed at right angles to the telescope. A half-silvered mirror is set into the telescope to reflect an image of the bubble into the eyepiece. The instrument may be used with a natural horizon by replacing the telescope with one of the usual form. The optical system is designed so that when the telescope is tipped the bubble image and the object sighted on move in the same direction and the same amount. Thus in making an observation it is sufficient to center the sun or star image with respect to the bubble image. The interesting feature of this instrument is the form of the bubble image as seen in the telescope. When the bubble is illuminated by

⁸ H. N. Russell, loc. cit.

light from the sky, the image consists of a central disk, clear and slightly larger than the sun's image, surrounded by a dark ring about as wide as the diameter of the disk. At night a lamp and a pinhole stop are used. The bubble itself, acting as a lens, forms a bright image of the pinhole, which appears like a star in the telescope. In either case it is very easy to judge when coincidence has been attained.

The Schwarzschild⁹ sextant shown in Figure 9 is a German instrument designed especially for use in balloons and airships. The instrument is essentially a rather compact marine sextant with a frame of aluminum alloy. The arc is graduated in degrees and read by a vernier to two minutes of arc. The index arm is operated by a knurled wheel geared to a rack on the frame; there is no clamping screw. The horizon consists of a bubble tube mounted below and in back of the horizon glass in a protecting case. In this case are also the lenses for bringing the bubble image into focus in the telescope and a right-angle reflecting prism. During the day the bubble may be illuminated by light reflected at a celluloid screen from the sky. The light passes through the bubble tube and lenses, is reflected through a hole in the horizon glass, and thence

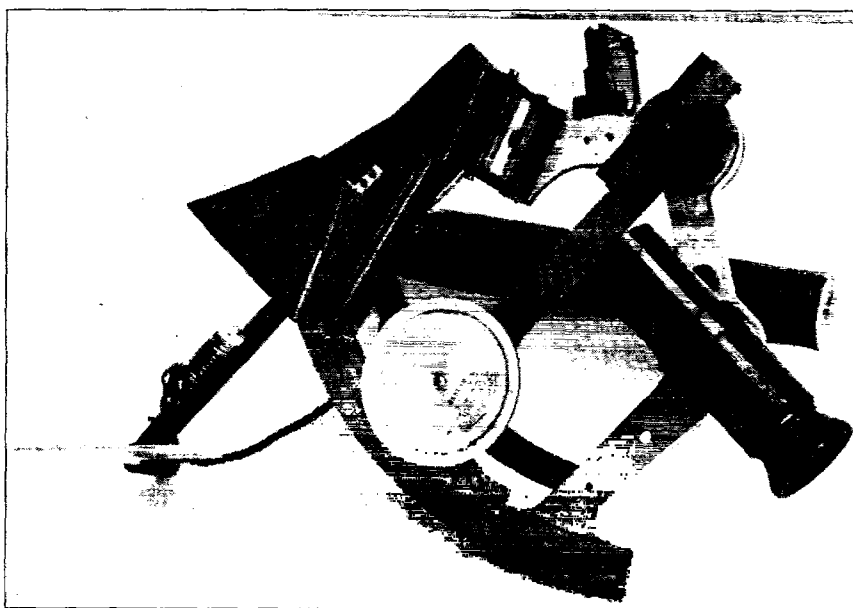

FIG. 9.—Schwarzschild sextant

enters the telescope. For night work the bubble is illuminated by an electric lamp in such a manner that the ends only of the bubble are seen in the telescope, thus \odot . Current is supplied by a battery in the handle, which also contains a rheostat for adjusting the intensity of the illumination. The lens system is so designed that the images of the bubble and the body under observation move in the same direction and at approximately the same speed when the sextant is inclined slowly. When the sextant is tipped with a rapid motion, the image of the object moves much the faster.

The R. A. E.¹⁰ (or Booth) bubble sextant was developed at the Royal Aircraft Establishment in England. A number of models varying considerably in details have been constructed. The instrument shown in Figures 10 and 11 is known as the Mark V, and is one of the later models. This sextant is a complete departure from marine practice, and an attempt has been made to meet all the requirements of an aircraft sextant. Figure 12 is a diagram of the optical parts of the instrument. The circular bubble, which is mounted in the chamber at B, is illuminated by daylight entering the lens O_1 and reflected by the prism P_1 . At night the lamp L may be used. The light passes through the bubble cell, is reflected at the pentagonal prism P_2 and

⁹ Zeitschrift für Flugtechnik und Motorluftschiffahrt, Vol. IV, No. 13, July 12, 1913. "Libellenhorizont und Libellensextant," by Prof. K. Schwarzschild.

¹⁰ "A Primer of Air Navigation," by H. E. Wimperis, 1920.

passes out through the lens O_2 to the index mirror M . The index mirror is a strip of unsilvered plane parallel glass which may be rotated about a horizontal axis through A . When observing the sun, the observer places his eye at E_1 . He then sees the bubble image through the index glass and an image of the sun reflected at the surface of the index mirror. If a star is to be observed, it is in general more convenient to view the star directly through the index mirror and the bubble by reflection, the observer's eye in this case being at E_2 . The bubble is formed by the vapor of the liquid (pentane, gasoline, or alcohol), and it may be adjusted to any convenient size by the adjustment shown diagrammatically at BA . The bubble cell connects by a tube with a chamber which is closed at one side by a corrugated metal diaphragm. By adjusting the pressure on the diaphragm, the volume of the inclosed system may be changed and thus a vapor bubble may be formed and regulated to the proper size.

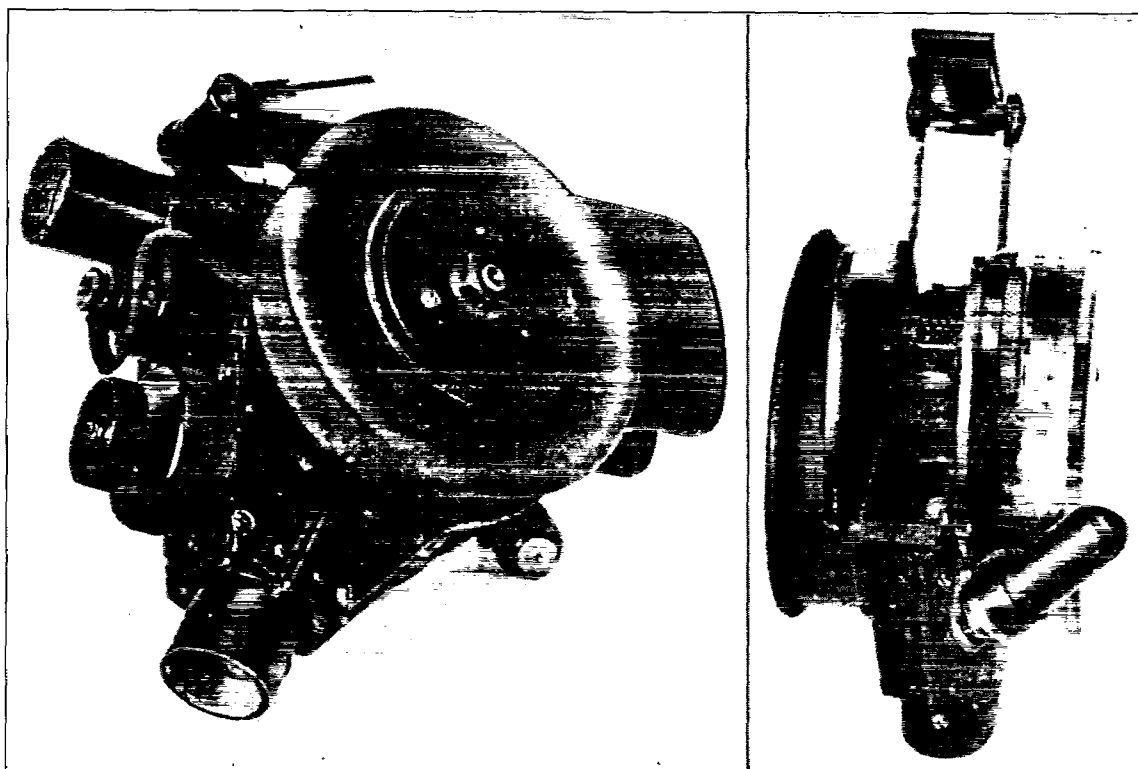

FIG. 10.—R. A. E. sextant, side view

FIG. 11.—R. A. E. sextant, end view

The index mirror is rotated by turning a large brass drum (shown in fig. 11). Two scales, graduated at $10'$ intervals and reading from -3° to 39° and from 39° to 80° , respectively, are engraved on the drum. Because of the open scales no vernier is necessary, the readings being made directly by reference to an index line on a strip of transparent celluloid. The index mirror (see fig. 12) is connected to the drum by a lever T held by a spring in contact with a spiral cam C inside of the drum. This cam is so constructed that approximately two revolutions of the drum correspond to an angular motion of the mirror equal to 45° (90° of altitude). On the other side of the instrument is a wooden rim serving as a handle, inside of which is an adjustable rheostat for varying the illumination of the bubble lamp. Current is supplied by a battery in the aircraft connected by a plug at a socket in the instrument. A lamp is also provided for illuminating the scales.

The optical elements are so designed that when the instrument is slightly displaced from its true position, the bubble moves with the sun's image. Furthermore, the lenses in combination form a telescope (power = 1), and thus it may be used to bring the natural horizon to the eye, in this way making it possible to use a natural horizon when this may be desirable.

A number of other bubble sextants for aircraft have been devised, of which those of Favé¹¹ and Coutinho¹² may be mentioned. The sextant of Coutinho was tested on the trans-Atlantic flight of Coutinho and Sacadura in 1922, with success it is said. Descriptions of these instruments are given in the references.

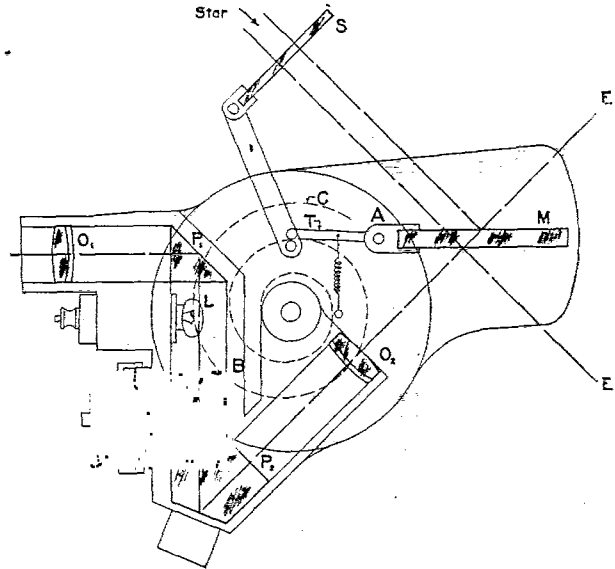

FIG. 12.—R. A. E. sextant, diagram

PENDULUM SEXTANTS

The Fischer sextant was designed by Ernst G. Fischer, formerly with the United States Coast and Geodetic Survey. The instrument consists of a marine sextant to which the artificial horizon is attached by a bracket as shown in Figure 13. Lamps are provided for illuminating the horizon

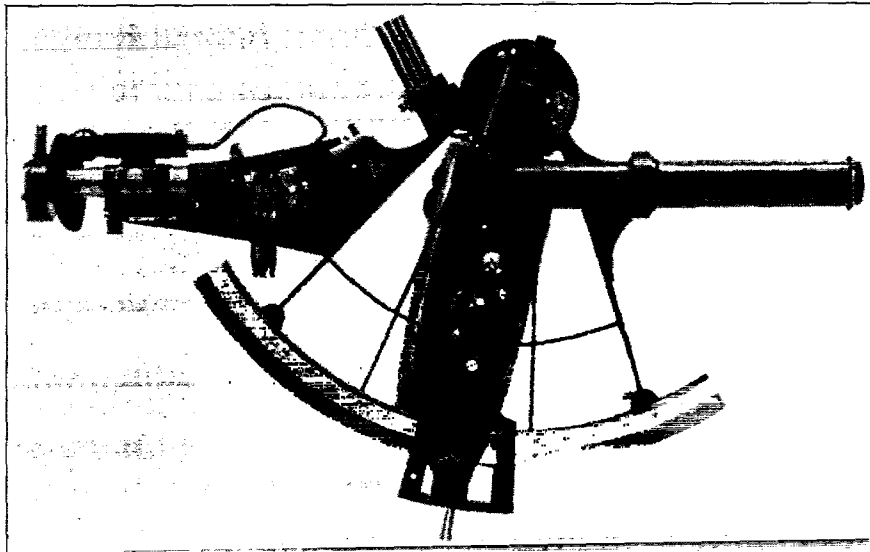

FIG. 13 —Fischer sextant

and the vernier, the current being supplied by a small battery in the handle. Push buttons are conveniently placed on the handle, and a small rheostat is supplied for varying the intensity of

¹¹ III^e Congrès International d'Aéronautique, Vol. 3, 1906. "Détermination du Point en Ballon," Favé.

¹² L'Aérophile, Vol. 31, No. 11-12, June, 1923. "La Méthode de Navigation de l'Amiral Gago Coutinho."

the horizon lamp. The index arm is provided with a clamping screw and a novel device for making the final setting rapidly and conveniently. This consists of two small pins, one fixed to the index arm and the other to the clamp in such a manner that the pins may be grasped simultaneously by the thumb and forefinger. When the clamp is tightened, the index arm can be moved in either direction by a twisting force applied to the pins.

Figure 14, taken from the patent drawings,¹³ illustrates the artificial horizon. The pendulums are mounted in a sealed chamber C containing a damping fluid. The pendulum P_1 consists of a vane of small mass and comparatively large area supported on knife edges. A small arm A_1 attached to the vane carries a piece of fine platinum wire W_1 set horizontally. A second pendulum P_2 is supported on an axis X in the plane of the sextant making an angle of 45° with the vertical. This pendulum carries a curved piece of wire W_2 . The horizontal wire W_3 is fixed to the wall of the chamber. The three wires lie at the principal focal point of the lens O so that they are all visible in the telescope of the sextant. The wires may be illuminated through a window N by light from the sky or by the lamp L.

With the sextant in the normal position for observation and the illumination properly adjusted, there are seen in the telescope two bright horizontal lines nearly meeting in the

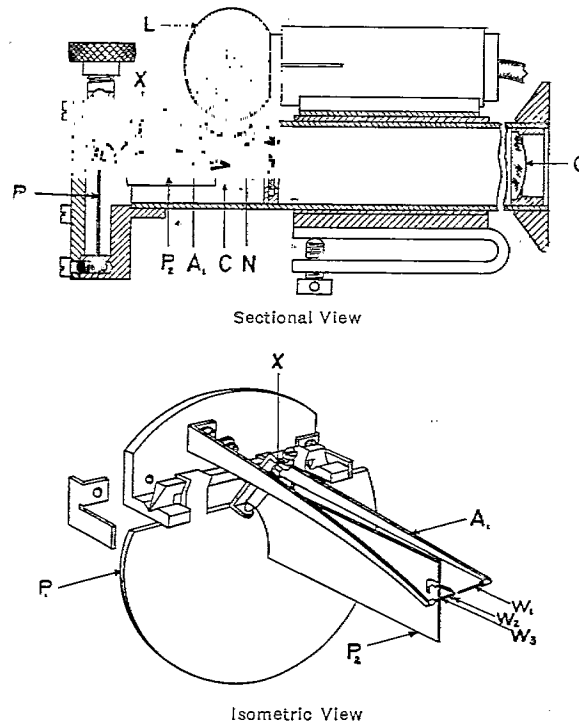

FIG. 14.—Fischer pendulum horizon

center of the field, one of which is fixed and the other movable; and also a small point of light just above or below the lines. When the lines are exactly opposite each other and the dot is immediately under or above the gap between the lines, the sextant is in the proper position for making the observation. The index arm is then adjusted until the image of the celestial body is tangent to or bisected by the horizontal line.

Great skill is required in handling the Fischer sextant. Three simultaneous coincidence settings must be made for each observation. The movable horizon line must be set to the fixed line, the point to the gap between the lines, and finally the star or the sun must be set on the line or tangent to it. Furthermore, the motions of the horizon line and the point are always opposite in direction to the motion of the image of the observed body when the sextant is slightly displaced from the true position.

¹³ U. S. Patent Office, Patent Specifications Nos. 1,386,695 and 1,409,933.

A pendulum sextant devised by Favé about 1901 or 1902,¹⁴ and one constructed by Keuffel & Esser for the trans-Atlantic attempt of Wellman and Vaniman¹⁵ are interesting from a historical viewpoint. A pendulum sextant has also been invented by Doctor Pulfrich, of Jena, but details of this instrument are not available.

GYROSCOPIC SEXTANTS

The first practicable gyroscopic sextant was devised in the latter part of the nineteenth century by Admiral Fleuriais, of the French Navy. An improved model, constructed by Ponthus & Therrode, of Paris, is shown in Figure 15. The instrument consists of a marine sextant attached to which is a cylindrical chamber behind the horizon glass and in line with the telescope. The chamber is closed by a cap in which is set a gauge for measuring the air pressure within. At the bottom are two air connections with stop cocks, one communicating directly with the interior and the other by ducts leading to several holes opposite the periphery of the gyroscope.

The gyroscope is a heavy, pivoted wheel bearing around its rim a series of vanes or cups. On the upper surface is mounted a light frame holding a lens and a grating with horizontal

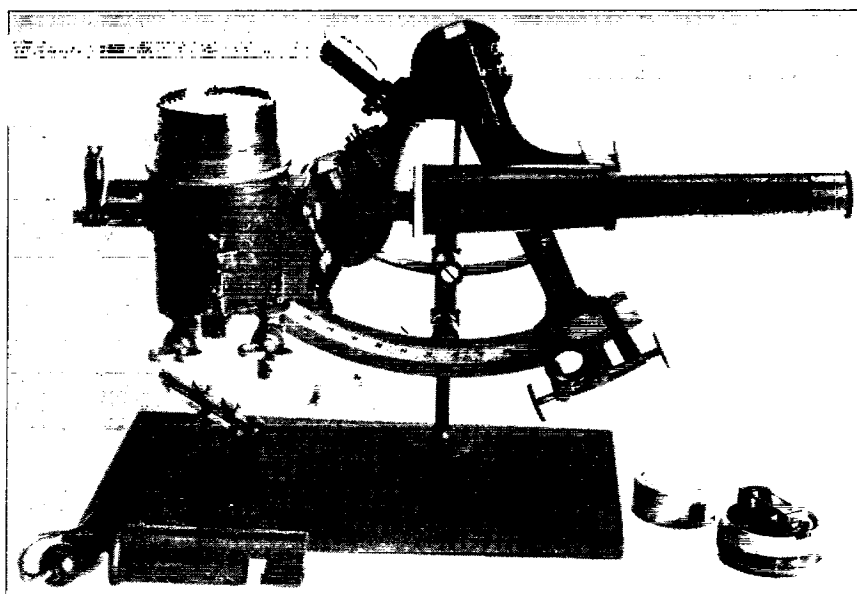

FIG. 15.—Fleuriais sextant

rulings, the distance between lens and grating being equal to the focal length of the lens. Two windows are placed in the chamber in line with the telescope. One is fitted with a tube projecting up to the telescope, and serving to shut out stray light. A mirror for reflecting sunlight or an electric lamp may be attached at the other window to illuminate the grating. A hand suction pump, a belt with an arm support, and an electric battery are furnished with the instrument.

In making an observation the gyroscope is set spinning by drawing air through the chamber by means of the pump. When sufficient speed is obtained, the inlet is closed and the pump worked until a partial vacuum is attained. Then the outlet is closed, the pump disconnected, and the instrument is ready for observing. An assistant is required to operate the pump and record the readings.

On looking through the telescope and adjusting the illumination, the grating can be seen as a series of bright lines on a dark field. The instrument should be held so that these bright lines are parallel to a fixed black line. The image of the body to be observed is brought into

¹⁴ III^e Congrès International d'Aéronautique, Vol. 3, 1906. "Détermination du Point en Ballon," by Favé.

¹⁵ "The Aerial Age," Wellman.

the center of the field by the usual sextant procedure. As the grating lines appear to move slowly up and down (due to precession), the extreme positions of the image are recorded, ten or more readings being made without disturbing the setting of the index arm. The time of each reading is also recorded.

Exhaustive studies of the Fleuriais sextant have been made by a number of investigators, notably Favé.¹⁶ A large number of tests have been made both on land and sea. In a total of 359 observations made at sea, about 70 per cent had errors of less than 2' and only about 3 per cent errors of 5' or more. Most of the readings were made during relatively calm weather; in rough weather the errors ranged usually from about 5' to 8'. Such an accuracy is attainable only by extreme care in the manipulation of the instrument; and by correcting the readings for instrumental errors, compensating for the effects of the earth's rotation, precession, and the motion of the star, and so on. The instrument, in its present form at least, does not appear to be suitable for aircraft because of the time and care demanded by the observation, the amount of calculation necessary, and the need for two observers.

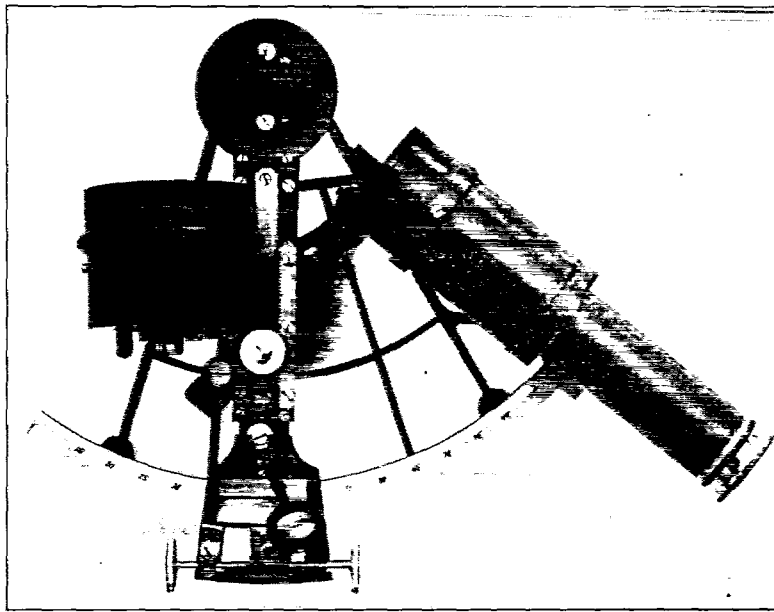

FIG. 16.—Derrien sextant

The Derrien sextant, Figure 16, is a French instrument which has been developed since the war. The sextant consists of a frame, similar to that of a marine sextant, with a graduated arc and a pivoted index arm with a vernier. The index mirror, half of which is silvered and half transparent, is mounted at the pivot point perpendicular to the axis of the index arm. A chamber housing the gyroscope is also mounted on the index arm in such a manner that it may be set at any distance from the index mirror. The upper surface of the gyroscope is polished to form a mirror. The telescope is fixed to the frame in such a way that its axis passes through the axis of the pivot.

When observing, the telescope is pointed directly at the star. The index arm is adjusted until an image of the body, reflected at the gyroscope mirror and again at the index mirror, is also seen. In order to accomplish this, the position of the gyroscope on the index arm must be adjusted according to the altitude of the observed body. The two images are set to coincidence, which will occur only when the index and gyroscope mirrors are parallel and (theoretically) horizontal. As yet no satisfactory results have been obtained with the Derrien sextant on board aircraft.

¹⁶ *Revue Maritime*, vol. 184, No. 580, January, 1910. "Le Point sans l'Horizon de la Mer," by Favé.

CORRECTION OF OBSERVED ALTITUDES

The true altitude of a celestial body at any point of the earth's surface is the angular elevation of its center from a plane perpendicular to the direction of the zenith at the earth's center. The observed altitude must be converted to the true altitude by the application of certain corrections; namely, the index, dip, refraction, parallax, and semidiameter corrections. Theoretically these should be applied in the order named, but except in the case of the parallax of the moon, as explained below, the order makes no material difference in practice.

INDEX CORRECTION

Generally the scale of a sextant does not read zero when the instrument is set to measure a zero angle. Thus there is a constant error in the indications of the scale; and this error having been determined, the proper correction can be applied to all readings. The error may be found by measuring a known angle, usually the zero angle. The correction is numerically equal to the error but of opposite sign.

It will be convenient to include under this heading any constant errors due to the artificial horizon. These errors are occasioned by the fact that it is impossible to adjust the artificial horizon with theoretical exactness. The manner of determining the correction will depend upon the instrument employed and will not be discussed here.

DIP

The dip is the angle of depression of the natural horizon due to the elevation of the observer above the level of the horizon. The effect of atmospheric refraction of the rays of light coming from the horizon is included in the dip correction. This effect depends upon the state of the atmosphere, but for the purposes of aerial navigation normal conditions may be assumed, and since the aircraft will usually be at a considerable elevation above the horizon, the errors due to this assumption will be negligible. The approximate value of the dip may be found by taking the square root of the observer's elevation above the horizon in feet, the result being the dip in minutes of arc. The dip correction is always subtracted from the observed altitude. Table I gives values of the dip correction for various elevations of the observer.

TABLE I
DIP CORRECTIONS

Height of eye, in feet	$\sqrt{\text{Height in feet}}$ = dip in min- utes of arc*	Russell's observed values, dip in minutes of arc
0	0.0	—
25	5.0	5
50	7.1	—
65	8.1	9
100	10.0	—
200	14.1	15
300	17.3	—
325	18.0	19
400	20.0	—
530	23.0	22
675	26.0	26
900	30.0	30
1,000	31.6	—
1,700	41.0	42
2,500	50.0	51
3,000	54.8	—
3,500	59.2	60
4,000	63.3	—
5,000	70.8	72
6,400	80.0	82
7,900	89.0	89
9,000	94.9	—
10,200	101.0	103
11,700	108.0	105
12,000	109.6	—

The empirical formula for the dip correction given above has been verified by Russell¹⁷ up to elevations of 10,000 or 12,000 feet. It is to be noticed that as the elevation increases the dip changes more and more slowly, so that at an elevation of about 10,000 feet the rate of change is 1' for about 200 feet. Therefore the elevation may be measured by an altimeter with sufficient accuracy. If a cloud or haze horizon is used, the elevation of the horizon must be measured as the aircraft ascends, or a dip measuring instrument must be employed. The dip correction is not necessary when using the Baker sextant or any artificial horizon sextant.

REFRACTION

A ray of light from any celestial body must pass through an optical medium of constantly increasing density, the atmosphere, before reaching the eye of the observer. Consequently the ray is deflected into a curved path, concave toward the normal at the point of incidence. Thus the apparent altitude of a body is greater than the true altitude, and a correction for refraction is necessary. This correction depends upon the altitude of the body, being zero for an altitude of 90° and a maximum when the altitude is zero. The amount of the refraction also varies according to the state of the atmosphere, but for the purposes of aerial navigation values calculated for average conditions are sufficiently accurate. The correction for refraction may therefore be tabulated in a convenient form. These corrections are only important for low altitudes and may usually be neglected for altitudes of 25° or over, since the corresponding corrections are never greater than 2'.

A further effect of refraction must be considered in connection with the dip correction. This, the so-called terrestrial refraction, is taken into account in the approximate rule given above for calculating the dip. Refraction also varies with the altitude of the observer above the earth's surface. The variation is small and may be neglected in practice under ordinary conditions. A short supplementary table will suffice for the cases where the correction is appreciable.

PARALLAX

Since the altitude of a body is measured at the observer's position on the surface of the earth instead of at the center of the earth, a correction for parallax is required. The parallax is the angle subtended by the earth's radius (to the observer's position) at the observed body. When the body is on the horizon the parallax reaches its maximum value, which is designated as the horizontal parallax. The correction for parallax is inappreciable in the case of the fixed stars, and in aerial navigation may be neglected except for the moon.

Tables have been prepared giving the moon's parallax in terms of altitude and horizontal parallax, which latter may be found in the Nautical Almanac. As the correction is large, the corrections for index error, dip, and semidiameter should always be applied first and the approximate altitude thus obtained used in entering the parallax tables. It is usual to combine the parallax and refraction corrections in one table.

SEMIDIAMETER

Often in the case of the sun or the moon the altitude of the upper or lower limb of the body is observed instead of the altitude of its center. The observed altitude must then be corrected by half the angular diameter of the body's disk, the semidiameter. True values of the semidiameters of the sun and moon are given in the Nautical Almanac, but for aerial navigation average values will suffice.

All these corrections, with the exception of the index correction, have been consolidated in forms convenient for the marine navigator in tables such as Tables 46 and 49 of the American Practical Navigator. For aircraft work similar tables, simplified and extended for greater heights of the observer, are necessary.

¹⁷ H. N. Russell, loc. cit.

ALTITUDE OBSERVATIONS THAT HAVE BEEN MADE ON BOARD AIRCRAFT

The sextant has been used to such a slight extent on board aircraft that it is not possible to state any specific rules as to the choice of an instrument or the procedure to be employed in making altitude observations. The final decision on these questions will depend on the experience and results gained in service by navigators of the air, and thus little can be given here other than a summary of what has been learned in the past and an indication of the present trend in development. It is evident, however, that quite different conditions obtain as regards airplanes and airships, and this fact must be taken into account not only in the choice of the instrument but also in the manner of using it and in the accuracy to be expected.

No great difficulties either in making observations or attaining sufficient accuracy are to be expected in the use of a sextant on board an airship, judging from such results as have been published, which are few in number. Bygrave¹⁸ in 1920 tested the R. A. E. sextant on board the British airship *R-33*. About 100 altitudes of stars and the moon were measured. Quoting from his report: "The readings could be taken as easily as on the ground, and the rapid and erratic movement of the bubble that is met with on airplanes is entirely absent. * * * By taking six observations, in the usual manner, with about 30-50 second intervals and taking the mean time and altitude, fore and aft observations would very seldom have an error of the mean exceeding 4' of arc. For athwartships observations the average of six would be within 5' of the true altitude in nearly all cases. This is quite accurate enough for all practical purposes.

"The R. A. E. sextant proved to be most convenient for star observations. With an * * * R. A. E. sextant * * * there should be no difficulty in obtaining an accuracy at least comparable with that obtained at sea in fast craft, such as destroyers, and certainly two or three times the accuracy obtainable in heavier-than-air craft should be obtainable." The R. A. E. sextant referred to was an earlier model than that illustrated in Figures 10 and 11.

On the trans-Atlantic flight of the *R-34* in 1919 an old pattern bubble sextant (experimental model) was found to be unserviceable, and the need for a satisfactory bubble sextant was called to attention. Good results were obtained with a naval sextant using either the sea or cloud horizons. It would seem that exceptionally good conditions were found for the use of cloud horizons.

Altitude observations are far more difficult from airplanes than from airships, and consequently the accuracy obtainable is much less. Russell¹⁹ in 1918 tested a marine sextant with an experimental pendulum horizon and also the Willson bubble sextant. The Willson sextant proved to be much superior. He found that, using this instrument, with very careful piloting the average error for the mean of a group of about six observations could be reduced to about 6' of arc, with an average error of about 13' of arc in a single reading. With ordinary piloting the errors were twice as great. Occasional wild readings could be easily detected and were rejected at the time of observation.

On a 1,000-mile experimental flight with a Handley-Page, carried out in England in 1919, a few position lines were obtained, using the R. A. E. sextant (Mark IIa). The mean of three to six readings was used in each case. The errors ranged from 5 or 6 miles up to as high as 30 or 40 miles. There appeared to be a close correlation between the weather and the accuracy, the best results being obtained when the air was calm.

Grieve, on the trans-Atlantic attempt of Hawker and Grieve, used a marine sextant, taking observations to cloud horizons with fairly satisfactory results.

On the Cape to Cairo flight in 1920, several sights were made with the R. A. E. sextant. Using the mean of 4 to 6 observations for each sight, position lines were obtained passing 7, 6, 10, and 15 miles, respectively, from the D. R. positions. Some error in the D. R. positions is included in these figures.

¹⁸ Aeronautical Research Committee (Gt. Brit.), Reports and Memoranda No. 702, September, 1920. "Some tests on navigation instruments during a flight of rigid airship H. M. A. *R-33*," by L. C. Bygrave, M. B. E.

¹⁹ H. N. Russell, loc. cit.

It is evident, therefore, that with proper precautions sextant observations can be made from both airships and airplanes with results accurate enough for the purposes of aerial navigation. On board airships there will be little or no difficulty. The navigator will have ample room and will be able to make his observations in comfort. The accuracy obtainable with a bubble sextant will vary between 5' and 10' of arc for the mean of half a dozen readings. On airplanes more care must be taken. The observer will generally be in rather cramped quarters and in an uncomfortable position, and the choice of instrument is therefore very important. The piloting must be of the very best to eliminate, as far as possible, the effects of accelerations. Under ordinary conditions an accuracy of 10' to 15' of arc should be attainable, although much larger errors may be expected if the weather is bad.

A sextant with an artificial horizon is absolutely necessary. The bubble type is probably the best at present because of its simplicity. Since the sea horizon will in general give more accurate results than the bubble, the bubble sextant should be so designed that the sea horizon may be used when available. Thus cloud horizons could also be used and, if desired, checked by the bubble. The instrument should be simple, rugged, and easy to manipulate. It should be of small size to reduce wind resistance, and as light as possible. The scale should be very legible, with rather heavy graduations, and need not be subdivided to smaller intervals than 5' or 10'. Verniers are very difficult to read and should be avoided.

V. AZIMUTHS

One of the disadvantages of the astronomical method of determining position lies in the fact that during the daytime the sun is, in general, the only body which can be observed. If the azimuth of the sun could be measured in addition to the altitude, a complete determination of position would be possible. The measurement of azimuths, however, is attended by numerous difficulties, and at the present time even the limited accuracy required by aerial navigation can not be attained.

The azimuth of a star is the angle between the meridian of the observer and the vertical circle of the star, measured east or west from the north or south point. An instrument for measuring azimuths must therefore be capable of indicating the horizontal and also some fixed direction (the north or south point). The first requirement necessitates an artificial horizon. As the artificial horizon has been discussed in connection with sextants, no further reference to this problem need be made here.

The second requirement demands some form of compass. Three distinct types of instrument are in use, namely, the magnetic compass, the earth inductor, and the gyroscopic compass. Of these the gyroscopic compass is the only one which, theoretically at least, will indicate the true north. However, it has not as yet been perfected for aircraft use, and great difficulties lie in the way of its development. The other two types indicate magnetic north, and in order to find the true azimuth the difference between magnetic and true norths, the magnetic declination, must be known. This fact introduces a further complication into the problem, for the value of the magnetic declination depends upon geographical position. The earth-inductor type of compass is still in the development stage, but gives indications of being considerably more accurate on board aircraft than the usual form of compass with the pivoted needle. It may prove to be of great value for azimuth determinations. The ordinary magnetic compass, at least in its present form, does not appear to be capable of sufficient reliability and accuracy for azimuth work except possibly on board airships.

Attempts to measure astronomical azimuths, for the purpose of obtaining a complete determination of position by observations of the sun only, have been few. Russell²⁰ in 1918 made a number of tests with a magnetic compass. He used a graduated card with a shadow pin mounted on his experimental pendulum horizon as a pelorus. Simultaneous readings of the compass and the pelorus were made. The probable error of an observation, each observa-

²⁰ H. N. Russell, *loc. cit.*

tion being the average of a set of 10 readings taken over a time interval of one to one and a half minutes, was $\pm 0.6^\circ$, and he concluded that excellent azimuths could be obtained with a magnetic compass. These results warrant further experimental work on this problem, but it does not seem probable that this accuracy can be attained under ordinary conditions on board airplanes.

Azimuth measurements, accurate within a degree or so, may be valuable under certain exceptional conditions. If, for instance, the dead-reckoning position should happen to be entirely unreliable, as might be the case on a long flight above clouds, and the only way of determining position were by observations of the sun, the observed azimuth could be used to find an interval along the position line determined by the altitude in which the aircraft would be located. The method involves considerable computation, however, and would be avoided except under exceptional circumstances.

VI. TIME

While a knowledge of the time is essential in the determination of position by astronomical methods, no difficulties are encountered in its measurement. The chronometer may be any

fairly good watch, adjusted for temperature, which will not gain or lose more than 5 or 10 seconds in 24 hours. For satisfactory results the chronometers must be given a reasonable amount of care. The rate must be checked occasionally in order to detect any great variations. The time should be checked at the beginning and conclusion of each trip; and during the flight the time signals sent out by the more important wireless stations may be used to advantage. For protection against the weather and extreme temperature changes the chronometers should be mounted in a suitable case. The case should be equipped with some shock-absorbing device for eliminating the effects of jars due to take-offs or landings and of the vibrations due to the motors.

Two chronometers are necessary. One of these should be set to Greenwich mean solar time and the other to Greenwich sidereal time. A third

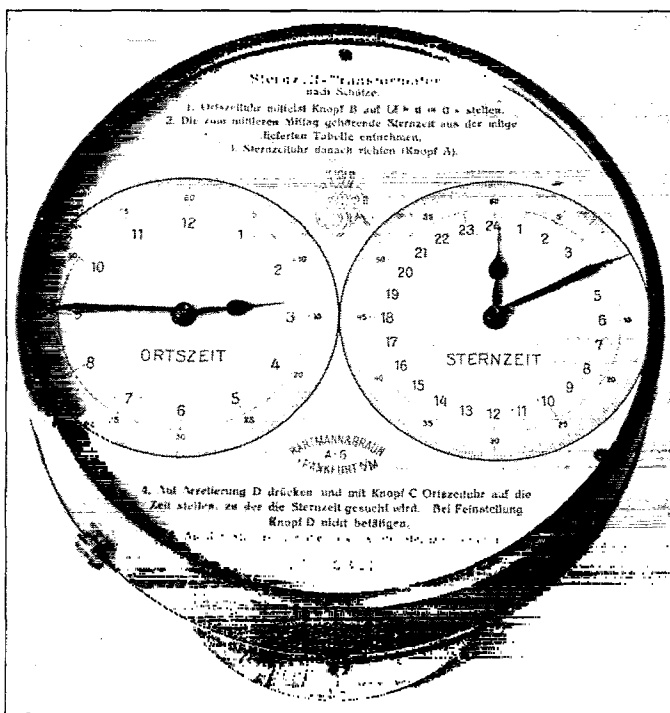

FIG. 17.—Sternzeit transformator

chronometer, while not absolutely necessary, would be a great convenience. It could be set to indicate apparent solar time for the meridian of Greenwich or any other convenient meridian. The indications of this chronometer would always be slightly in error, but, since the change in the equation of time is never more than 30 seconds in 24 hours and usually very much less, the resulting errors may be ignored provided the chronometer be set for each trip. A further advantage of three chronometers lies in the fact that errors in any one may be readily detected.

While it is not a time-measuring instrument, mention may here be made of the "Sternzeit transformator"²¹ shown in Figure 17. This instrument is designed for the rapid, mechanical conversion of sidereal to solar time and vice versa. On the face of the instrument are two

²¹ Deutsche Luftfahrer-Zeitschrift, Vol. XVII, No. 3, Feb. 5, 1913. "Sternzeit-Transformator," by Alfred Schütze.

clock dials, each with its hour and minute hands, one figured in 12 hours and labeled local time (Ortzeit) and the other figured in 24 hours and labeled sidereal time (Sternzeit). The hands on each face may be moved independently or simultaneously by means of appropriate thumb nuts. Suppose the sidereal time corresponding to 3.10 p. m. (any given meridian) is required. Set the local time dial at 12. Set the sidereal time dial to the sidereal time for noon of the same day, as found from the Nautical Almanac. Then turn both simultaneously until the local time dial indicates 3.10 p. m. The sidereal time dial will show the required sidereal time.

A third dial, graduated in degrees, is fixed at the back of the instrument. By means of this and the local time dial angular units may be converted into time units or the reverse. The advantages of this instrument are more apparent than real, as the tables which it replaces are short, easily used, and require no interpolations.

VII. THE NAUTICAL ALMANAC

The American Ephemeris and Nautical Almanac and the Nautical Almanac are published annually by the Nautical Almanac Office of the United States Naval Observatory. Copies may be obtained from the Superintendent of Documents at Washington, D. C.

The American Ephemeris and Nautical Almanac is divided into three parts. Part I contains ephemerides and other fundamental astronomical data for the sun, moon, and planets for the meridian of Greenwich. Part II gives ephemerides of the fixed stars, sun, moon, and major planets for the meridian of Washington. Part III contains predictions of phenomena, with data for their computation. Various tables for finding latitude from altitudes of Polaris, conversion of times, and so on, are also included.

The Nautical Almanac, which contains extracts from the American Ephemeris and Nautical Almanac, is intended especially for the purposes of navigation. The positions of the sun, moon, and major planets are given for the meridian of Greenwich. The apparent places of 55 stars and their times of transit at Greenwich and the mean places of 110 additional stars are given. Solar and lunar eclipses are described, and various useful tables are included. This book contains all the fundamental astronomical data which are necessary for navigation. Since it is compiled for the use of marine navigators, much of the material is given in greater detail than is necessary for aerial navigators, and much could be dispensed with entirely.

VIII. THE REDUCTION OF OBSERVATIONS

METHODS

The discussion of the reduction of observations will be limited to those methods by which a position line is determined from an observed altitude, since at the present time the altitude is the only quantity which can be measured in practice. It will be convenient to consider not only the actual computations involved but also in some cases the plotting of the position line on the map or chart. The problem of devising simple, rapid, and accurate methods has received much attention during the past 20 or 30 years, and as a result a number of very practical and convenient methods have been worked out, almost all of which are based on the procedure due to Marcq St. Hilaire. The basic problem in the reduction of observations is the solution of a spherical triangle, the astronomical triangle. According to the means adopted for solving this triangle, the various methods which have been proposed may be classified as:

- (1) Logarithmic solutions.
- (2) Tabular solutions.
- (3) Solutions by means of nomograms and diagrams.
- (4) Graphical solutions.
- (5) Mechanical solutions.

In Figures 18 and 19, representing the astronomical triangle, the vertices P, S, and Z correspond to the pole, the substellar point, and the observer's position, respectively. The following notation will be used:

- L = latitude.
- λ = longitude.
- R. A. = right ascension.
- D = declination.
- h = altitude.
- $\phi = 90^\circ - L = \text{side PZ}$.
- $p = 90^\circ - D$ (polar distance) = side PS.
- $z = 90^\circ - h$ (zenith distance) = side ZS.
- t = hour angle = angle SPZ.
- A = azimuth = angle PZS.

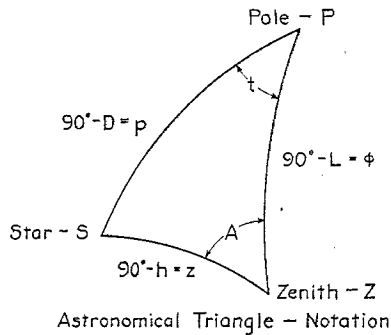

FIG. 18

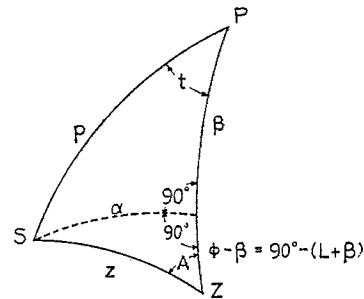

FIG. 19

In the application of the St. Hilaire method, the altitude and azimuth of the observed star must be calculated for some assumed geographical position at the time of observation. From spherical trigonometry we have the formulas:

$$\cos z = \cos \phi \cos p + \sin \phi \sin p \cos t$$

and $\frac{\sin A}{\sin p} = \frac{\sin t}{\sin z}$

which may be reduced to—

$$\sin h = \sin L \sin D + \cos L \cos D \cos t \quad (\text{I})$$

$$\text{and } \sin A = \cos D \sec h \sin t \quad (\text{II})$$

giving expressions for the altitude and azimuth, respectively.

In these formulas, L is the latitude of the assumed geographical position, usually the dead-reckoning (D. R.) position. The declination (D) for the time of observation may be found in the Nautical Almanac. The hour angle (t) is derived from the longitude of the assumed position and the time of observation. The methods of reckoning time, the conversion of time, and the calculation of hour angles will not be discussed here, since they are treated at length in all navigation textbooks.²²

1. LOGARITHMIC SOLUTIONS

Equations I and II may be solved with the aid of logarithmic tables. In the practice of navigation at sea, the altitude is computed and the azimuth is usually found from azimuth tables. Defining the haversine of an angle as the sine squared of one-half the angle, formula (I) may be rewritten as—

$$\text{hav } z = \text{hav } (L \pm D) + \cos L \cos D \text{ hav } t \quad (\text{III})$$

which gives the zenith distance in terms of the latitude, declination, and hour angle. In this formula, which is known as the cosine-haversine formula, the quantities are always positive and all doubt as to algebraic signs is avoided.

²² American Practical Navigator, Bowditch. U. S. Hydrographic Office, Navy Department.

In order to make possible a solution with the use of only one table, the formula (III) may be reduced to the following form:

$$\begin{aligned} \text{hav } z &= \text{hav } (\phi \pm p) + \{\text{hav } (\phi + p) - \text{hav } (\phi - p)\} \text{hav } t; \\ \text{or } \text{hav } z &= \text{hav } (L \pm D) + \{\text{hav } (180^\circ - (L + D)) - \text{hav } (L - D)\} \text{hav } t \end{aligned} \quad (\text{IV})$$

Equation IV, the haversine formula, is very readily solved with the aid of a single table giving logarithmic and natural haversines in parallel columns.

Except on board the larger airships, it is very difficult to make any computations in the air, and, besides, the time required for the work is a great disadvantage. Accordingly, it has been proposed that the calculations be made on the ground just before the flight is begun. Certain positions along the probable route are assumed; and altitudes and azimuths of such stars as are likely to be observed are computed for these assumed positions. The altitudes and azimuths at each position are tabulated for an interval such that it will include the time when the aircraft is expected to be near the chosen point. A chart must be used which is drawn to such a projection that large intercepts can be plotted without serious errors. The computed azimuths may be laid off in advance for each assumed position.

This procedure is open to several objections. The actual work required is increased even though it may be made on the ground. If for any reason the time of the trip is changed or the route altered, all the computations are useless, and a new set of values must be calculated. Also the weather conditions may be such that observations can not be made at the predetermined times.

2. TABULAR SOLUTIONS

It is impossible to tabulate the solutions of all the spherical triangles which may arise in the practice of navigation. However, by the use of certain approximations and interpolations tables of simultaneous altitudes and azimuths may be constructed which will obviate the necessity of logarithmic computations. Such tables are given in Publication No. 201 of the United States Hydrographic Office, entitled "Simultaneous altitudes and azimuths of celestial bodies." These tables are constructed for all latitudes from 0° to 60° north or south and declinations from 0° to 24° north or south, both at 1° intervals. Hour angles are given at 10-minute intervals. While according to the St. Hilaire method altitude and azimuth are computed for the dead-reckoning position, it is evident that any other position near the true position may be used. Thus in employing these tables in order to avoid unnecessary interpolations, an assumed position may be taken at an even degree of latitude and at a longitude which will make the hour angle an even multiple of 10 minutes. Then the only interpolation will be for declination. Publication No. 201 is primarily intended for observations on the sun, but may also be used for any of the stars or planets whose declinations may lie within the limits of the table. Similar tables for the brighter fixed stars could be readily computed. These tables are rather bulky, but they are very convenient and allow a very rapid determination of the position line.

The altitude or position-line tables of Frederick Ball,²³ intended for the same purposes as Hydrographic Office Publication No. 201, are published in three volumes. The first volume covers latitudes from 0° to 30° and the second volume latitudes from 31° to 60°, both for declinations from 0° to 24°. A supplementary volume, the third, includes latitudes from 24° to 60° and declinations from 24° to 60°. These tables give altitudes in terms of latitude, declination, and hour angle, latitudes and declinations being tabulated for 1° intervals and hour angles at intervals of 4 minutes. Supplementary tables are provided for finding azimuths.

A new set of tables, United States Hydrographic Office Publication No. 203, has recently been published. These give the simultaneous values of hour angle and azimuth for values of the observer's latitude and the declination and altitude of the observed star at intervals of single degrees. The tables include declinations within 28° of the celestial equator and latitudes from 60° north to 60° south. The differences of hour angle and of azimuth for a change of 1' in declination are also given for convenience in interpolation for the declination of the observed

²³ Altitude or Position Line Tables, by Frederick Ball. J. D. Potter, London.

star. In practice, the tables are entered with the integral number of degrees of latitude nearest the dead reckoning and similarly for the altitude. By interpolation for declination the hour angle and azimuth may be found. Then using the tabular altitude, the hour angle, and the azimuth, a position line may be drawn. Since the true observed altitude was not used in entering the table, this position line must be shifted by a distance in nautical miles equal to the difference in minutes of arc between the altitude given by the tables and the observed altitude. In most cases the shifted line may be considered to have the same direction as the initial line. Tables of corrections are given for the cases where the shifted line requires a change in azimuth. If the map projection represents angles true to nature and also represents great circles as straight lines, no change in the azimuth of the shifted line is necessary. Full directions are included with the tables. These tables offer many advantages and may prove to be of considerable value in aerial navigation.

The solution of the astronomical triangle may be reduced to the solution of two right-angled triangles formed by passing an arc through the substellar point and perpendicular to the observer's meridian. The de Aquino tables, which are based on methods devised by Sir William Thomson (Lord Kelvin), comprise tabular solutions of the right-angled spherical triangle in a form convenient for the solving of the astronomical triangle. Since the values of one quantity are tabulated only for each degree and the other for every half degree, special methods must be used in order to avoid laborious interpolations. Instead of using the dead-reckoning position, an assumed position is taken such that the arguments for entering the tables will be even degrees or half degrees, as the case may be. These tables may be found in Publication No. 200 of the United States Hydrographic Office, in which are also given detailed instructions as to the manner of employing them. As the procedure is not always the same, certain rules or precepts are required. These precepts and the necessary interpolations increase the chances for error, so that this method does not appear to be suitable for aerial navigation. Publication No. 200 also contains haversines and the other tables employed in computing the zenith distance and finding the azimuth in the practice of the Marcq St. Hilaire method arranged in the order in which they are used, according to the cosine-haversine formula.

Tables²⁴ may be constructed from which latitude and local sidereal time may be found directly from the altitudes of two stars. Such tables would eliminate all computations and even the use of the Nautical Almanac. Unfortunately, however, in order to reduce the tables to a practicable size, the altitudes can not be tabulated at closer intervals than a degree, or half a degree at the most. Double interpolations are thus necessary, and the advantages of the tables are nullified to a great extent.

A set of very simple tables has been proposed by Leick²⁵ for the determination of latitude by observations of Polaris. If the altitude (h) of Polaris be measured, the latitude (L) of the observer may be found by the equation

$$L = h + Dh,$$

where Dh is a correction depending on the time and place of observation. This correction can be obtained if the local sidereal time is known; but in order to avoid the difficulties of this method, Leick suggests the measurement of the altitude of any star near the prime vertical and determining the correction from this second altitude by tables. This second altitude demands no great care, since an error of half a degree, and in some cases even 1° or 2° , has no appreciable effect on the result. Table II contains values of Dh given in terms of the altitudes of a number of stars. The manner of using the tables is obvious. Table II is calculated for a latitude of 50° north. However, it may be used for all latitudes between 45° and 55° north with an error never greater than about $2'$ and in most cases less than $1'$ of arc. Similar tables for every 10° of latitude can readily be computed.

²⁴ H. E. Wimperis, loc. cit.

²⁵ Deutsche Luftfahrer-Zeitschrift, Vol. XVII, No. 7, April 2, 1913. "Über die Bestimmung der Geographischen Breite aus Polarnsternbeobachtungen." by Dr. W. Leick.

TABLE II

Altitude of star	Correction—add algebraically to altitude of Polaris											
	Arcturus		Betelgeux		Denebola		Pollux		Regulus		Sirius	
	East	West	East	West	East	West	East	West	East	West	East	West
6												
8												
10			-65	+61	-36	+24						
12			-67	+59	-32	+28						
14	+12		-67	+58	-29	+31						
16			-68	+56	-25	+35						
18	+16	-11	-69	+54	-22	+38	-69	+69	-45	+61		
20	+19	-8	-69	+51	-18	+41	-69	+69	-43	+62		
22	+23	-4	-69	+48	-15	+44	-69	+69	-39	+64		
24	+26	0	-69	+45	-11	+46	-69	+69	-36	+65		
26	+30	+4	-69	+42	-7	+49	-68	+69	-33	+66		
28	+33	+7	-69	+39	-3	+52	-68	+69	-30	+67	+16	-33
30	+37	+11	-68		0	+54	-67	+69	-26	+68	+12	-37
32	+40	+15	-67		+4	+57	-66	+68	-22	+69	+8	-40
34	+43	+19			+8	+59	-65	+67		+69	+4	-43
36	+45	+23					-64	+67			+1	-45
38												
40												
42												
44												
46												
48												
50												
52												
54												

Example:
 Altitude of Polaris..... $h=49^{\circ} 16'$
 Altitude of Regulus (in west)=15°..... $Dh= +60'$
 Latitude..... $L=50^{\circ} 16'$

3. SOLUTIONS BY MEANS OF NOMOGRAMS AND DIAGRAMS

The haversine formulas for zenith distance and azimuth may be written in the form of the straight line equation

$$y = b + mx$$

as follows:

$$\begin{aligned} \text{hav } z &= \text{hav } (L - D) + \{ \text{hav } (180^{\circ} - (L + D)) - \text{hav } (L - D) \} \text{hav } t \\ \text{hav } (90^{\circ} \pm D) &= \text{hav } (L - h) + \{ \text{hav } (180^{\circ} - (L + h)) - \text{hav } (L - h) \} \text{hav } A \end{aligned}$$

These formulas may be solved on a nomogram which was first published in 1899 by D'Ocagne in his "Traité de Nomographie."

Let the sides of a square (fig. 20) be divided according to the haversines of angles from 0° to 180° and the corresponding points on opposite sides be connected by straight lines. The left-hand side is numbered from bottom to top in degrees and the right-hand side in the reverse order, likewise in degrees. The upper and lower edges are numbered from left to right in degrees and in time units, respectively.

To find zenith distance, enter the diagram at the left with $L - D$ and at the right with $L + D$, and join these points by a straight line. Find the hour angle (t) at top or bottom and follow along the vertical to the straight line already determined. Then pass horizontally to the left-hand scale and read off the zenith distance.

To find the azimuth, the left and right hand scales are entered with $L - h$ and $L + h$, respectively, and the straight line drawn as before. The left-hand scale is then entered with $90^{\circ} - D$ and the horizontal followed to the straight line. The vertical from this point is followed to the top scale from which the azimuth is read.

If the altitude, or zenith distance, be known, the hour angle may be determined by reversing the last two steps in the procedure for finding the zenith distance.

The nomogram is simple and convenient, but unfortunately has one great disadvantage. If it be made about 15 inches square, an accuracy in zenith distance of about 7' of arc is possible. An accuracy of at least 2' or 3' of arc is desirable for aerial navigation, and for this accuracy the diagram would be inconveniently large. Furthermore, it can not be subdivided, but must be used as a whole. This nomogram has also been published by Wimperis under the name of "Spherical triangle nomogram,"²⁶ and by Littlehales as the "Altitude, azimuth, and hour-angle diagram."²⁷

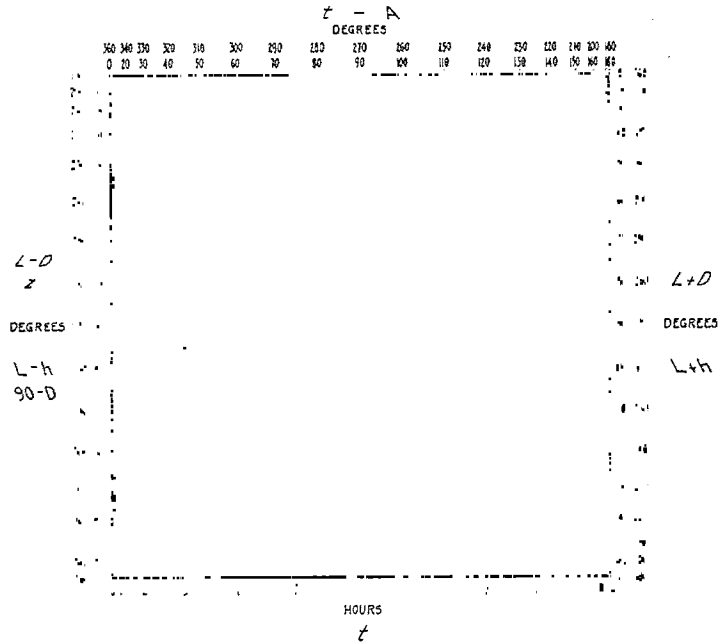

FIG. 20.—D'Ocagne nomogram

If the astronomical triangle be divided into two right triangles, as shown in Figure 19, the following formulas express the relations between the various parts:

$$\begin{aligned}\cos (90^{\circ} + D) &= \cos \beta \cos \alpha \\ \cot t &= \cot \alpha \sin \beta \\ \text{and } \cos A &= \cos \{(90^{\circ} - L) - \beta\} \cos \alpha \\ \cot z &= \cot \alpha \sin \{(90^{\circ} - L) - \beta\}\end{aligned}$$

It is evident that the two sets of equations are of the same form, and thus a graphical representation of the first set will also represent the second set. Taking β as abscissa and α as ordinate and plotting values of D and t , the diagram in Figure 21 will be obtained, by means of which the astronomical triangle can be solved in two steps. The procedure is as follows: Find the intersection of the curves corresponding to the given declination (D) and hour angle (t), and read the coordinates α and β of this point. Determine a new value of β according to the relation $\beta' = \{(90^{\circ} - L) - \beta\}$. Locate the point whose coordinates are α and β' . Find the azimuth (A) and zenith distance (z) corresponding to this point by means of the declination and hour-angle curves, respectively, interpolating between the curves if necessary. Since the diagram represents only an octant of a spherical surface, provision must be made for the solution of all astronomical triangles which may be met with in practice. This may be done in either of two ways. The diagram may be enlarged to show three octants, or additional graduations may be applied to the curves and scales, with appropriate rules for each case. The diagram was published by Favé and Rollet de L'Isle in 1892.²⁸

²⁶ H. F. Wimperis, loc. cit.

²⁷ Proceedings U. S. Naval Institute, November, 1917. "Altitude, azimuth, and hour-angle diagram," by G. W. Littlehales.

²⁸ Annales Hydrographiques, 1892. "Abaque pour la Détermination du Point à la Mer," by Favé and Rollet de L'Isle.

Numerical operations are reduced by the use of this diagram to a single addition or subtraction, and a complete solution can be obtained in two or three minutes' time. Deformations of the paper have no effect on the accuracy. A scale of 2 millimeters = 10' of arc is required for an accuracy of 1', which means a diagram about 40 inches square. This may be divided into sheets of convenient size, but the chances for error are thereby increased. The necessity for a set of rules to determine the procedure to be employed is also a disadvantage.

Consider a sphere on which are drawn the meridians and parallels properly numbered, and on this sphere draw the astronomical triangle ZPS. (See fig. 1.) Let this triangle be moved over the surface of the sphere in such a manner that the side ZP will always remain on the same meridian and until the vertex Z coincides with the original position of P. Or, in other words, rotate the triangle over the surface of the sphere about an axis through the equator and

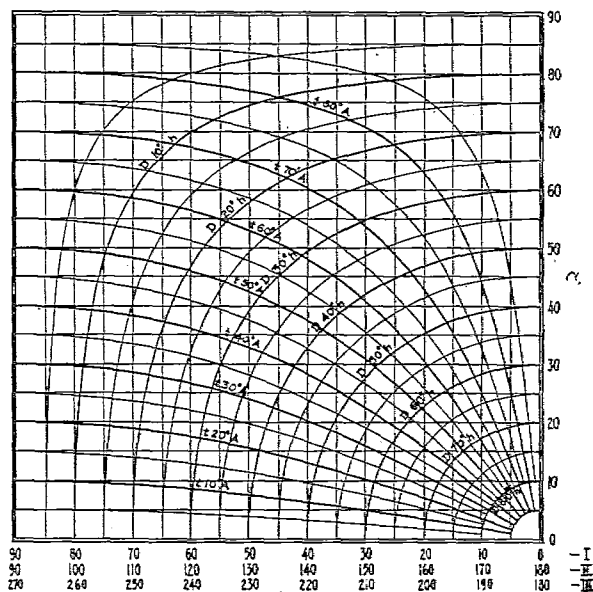

- $\beta' = \beta + (90^\circ - L)$
- Case 1. L and D same name - $t < 90^\circ$
Read β on scale II
Azimuth from upper pole, E or W as star is E or W of meridian
 - Case 2. L and D same name - $t > 90^\circ$
Read $(180^\circ - t)$ instead of t
Read β on scale I
Azimuth from upper pole, E or W as star is E or W of meridian
 - Case 3. L and D opposite names
Read β on scale I
Azimuth from lower pole, E or W as star is E or W of meridian

FIG. 21.—Favé diagram

perpendicular to the meridian ZP. The side ZS, which is the zenith distance, will now coincide with some meridian, and its length may be read off directly. The angle SZP, which is the azimuth, will have its vertex at P and its sides along two meridians. Its value may thus be determined directly from the graduated circles. If an accuracy of a minute of arc is required, such a sphere would be inconveniently large, but any true projection of the sphere could be used instead.

The stereographic meridian projection has been employed by Littlehales,²⁹ of the United States Hydrographic Office, for this purpose. The projection is for a 12-foot sphere and, since it is very large, has been subdivided into 368 overlapping sheets. These, together with a key diagram, are bound in one volume, which is rather bulky and not very convenient for aircraft use. An accuracy of about 1' or 2' of arc is obtainable in practically all cases, and the procedure is rapid and fairly simple.

²⁹ "Altitude, Azimuth, and Geographical Position," by G. W. Littlehales. Published by Lippincott.

The Mercator projection has been used in a similar manner by Commander Veater,³⁰ of the British Navy. The observer's meridian is taken as the equator of the projection, and rotation on the sphere becomes translation parallel to the observer's meridian on the projection. The projection is divided into sections of a convenient size and a key diagram is furnished.

The nomograms and diagrams which have thus far been described are perfectly general in application and may be used for observations of the sun or moon as well as the stars and planets. The changes in the right ascensions and declinations of the fixed stars are very small, and for the purposes of aerial navigation these stellar coordinates may be considered as constants for periods of several years. Thus a variety of diagrams is possible for the reduction of observations of the fixed stars. A few of these are here described for illustration and because under certain conditions they may prove to be of value to the navigator.

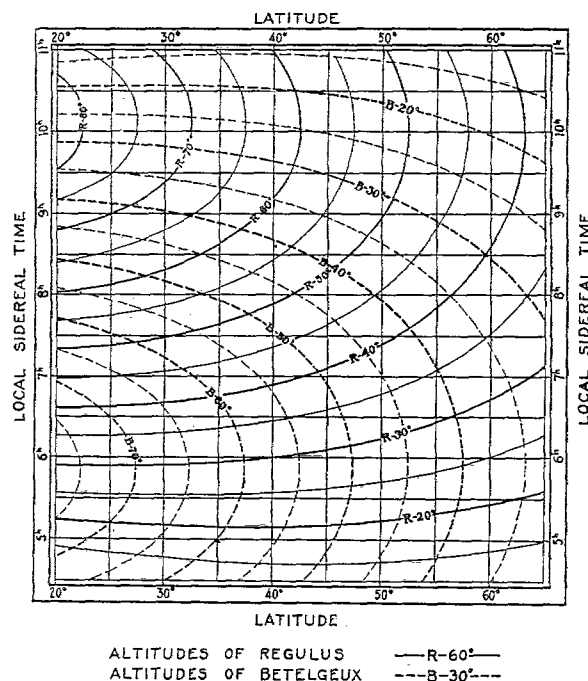

Fig. 22.—Two star diagram

Local sidereal time and latitude are completely determined by the simultaneous altitudes of two stars. If latitudes be taken as abscissæ and local sidereal times as ordinates, curves showing the simultaneous altitudes of two given stars may be constructed, as in Figure 22.³¹ From this diagram, and the Greenwich sidereal time as indicated by his chronometer, the navigator can determine his position. No tables are required; even the Nautical Almanac is unnecessary. All computations, including the calculation of hour angles, are eliminated, save the simple addition and subtraction required to find the longitude from the local and Greenwich sidereal times. Suppose, for example, that on a flight in the United States the following observations were made:

Altitude of Regulus, 47°.

Altitude of Betelgeux, 52°.

Greenwich sidereal time, 13 hours 20 minutes.

Find on the diagram the point corresponding to the given altitudes, interpolating between curves where necessary. Read the abscissa of this point giving a latitude of 39° (in round numbers), and the ordinate giving a local sidereal time of 7 hours 30 minutes. Then subtract the local from the Greenwich sidereal time, giving a longitude of 5 hours 50 minutes, or 87°

³⁰ H. E. Wimperis, loc. cit.

³¹ Proposed by the author.

30' west. The position, a point in southeastern Illinois, can now be plotted on the map. If the sky happens to be overcast, and only one star is visible, two latitudes (or local sidereal times) may be assumed and the corresponding coordinates found from the diagram. The two points thus found will determine a position line on which the aircraft must be located.

For practical purposes such diagrams should have an accuracy of 2' or 3' of arc. This may be attained by a scale of about 1 inch to 1° of latitude and correspondingly for the local sidereal time. Then a latitude range of 20° (covering practically all of the United States) would require a diagram 20 inches in width. Using five or six pairs of stars suitably chosen, diagrams would be available for all nights of the year over this latitude range. These might be conveniently placed on one sheet of paper placed on rollers in a case similar to the usual form of map case.

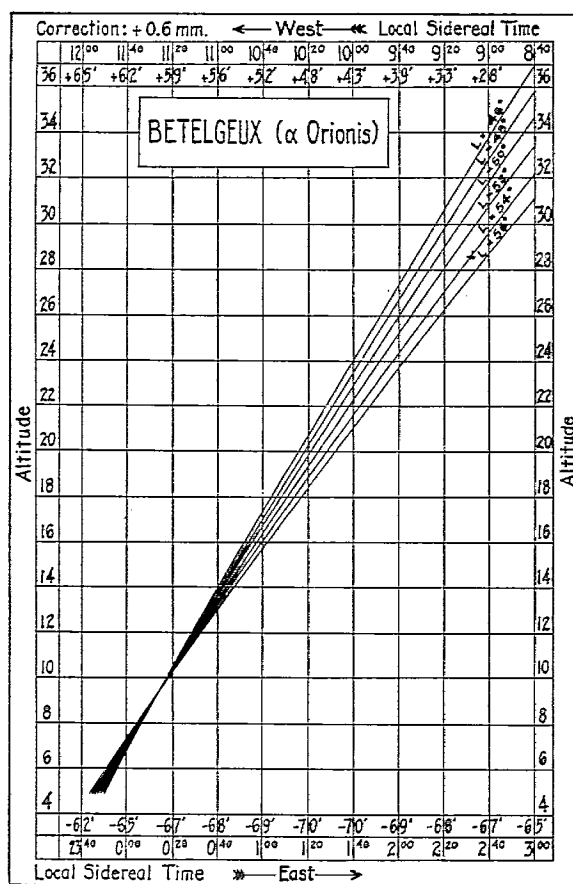

FIG. 23.—Leick diagram

The advantages of this form of diagram are the complete elimination of computations and supplementary tables, and the simple and very rapid procedure. The chief disadvantage lies in the fact that the diagram can be used only at night. Where space is limited, the diagram can be subdivided to cover a range of 10° of latitude in each roll, having a width of about 10 inches, which is not too large for even the smallest airplanes on which its use would be necessary or desirable.

The diagram shown in Figure 23 was published by Leick³² in 1911. Given the altitudes of Polaris and one other star, local sidereal time, and hence longitude and latitude may be determined. An example (given by Leick) will illustrate the use of the diagram.

³² Annalen der Hydrographie und Maritimen Meteorologie, Vol. 39, No. 6, June, 1911. "Ein Verfahren zur Auswertung astronomische Ortsbestimmungen im Ballon bei Nacht," by Dr. A. Leick.

Given:

Altitude of Polaris = $h_1 = 55^\circ 35'$.

Altitude of Betelgeux = $h_2 = 20^\circ 43'$ (east of meridian).

Greenwich sidereal time = 0 hours 19.8 minutes.

Along the left or right hand scales find $h_2 = 20^\circ 43'$. Follow the horizontal to the latitude curve $L = h_1 = 55^\circ 35'$, and from this point pass vertically downwards and find $Dh = -70'$. Then the latitude of the observer = $L = h_1 + Dh = 54^\circ 25'$. Now enter the left or right hand scales as before, with h_2 , and pass horizontally to the latitude curve $L = 54^\circ 25'$, and from this point downward to the time scale, from which find the local sidereal time $t_x = 1$ hour 32.8 minutes. Then the longitude of the observer = $\lambda = t_x - t_0 = 1$ hour 13 minutes or $18^\circ 15'$. It is to be noticed that readings of the upper scales require corrections. The point on the scale as found by the solution should be transferred 0.6 millimeter in the direction of the arrow, and the scale reading of this new point is the required result.

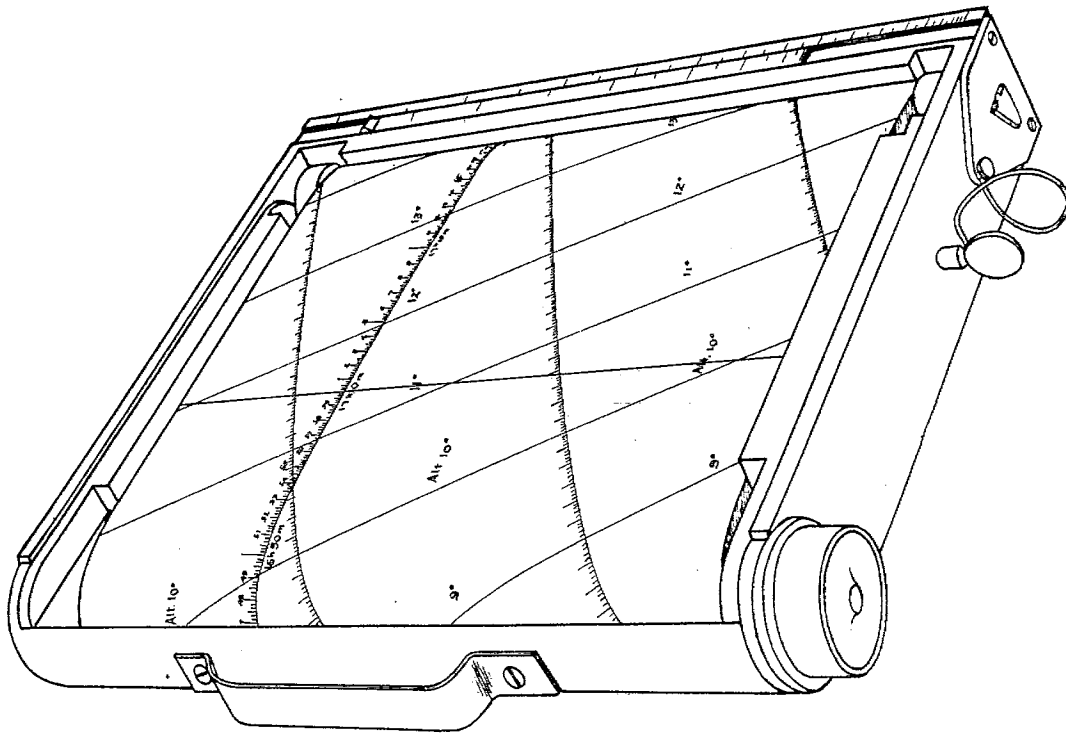

FIG. 24.—Baker navigating machine

4. GRAPHICAL SOLUTIONS.

At any instant the curves of equal altitude for a given star may be considered as a system of circles about the substellar point as center. These circles, together with their great circle orthogonals, may be imagined as a network moving over the surface of the earth from east to west with the change of time and slowly north or south according to the changes in declination of the star. Now if the navigator has a map and a transparent sheet on which are plotted the curves of equal altitude (to the same projection and scale as the map), he can locate the sheet of curves on the map according to the geographical position of the star, and the curve corresponding to his observed altitude will then be his position line. This principle has been used by Commander Baker³³ of the British Navy in the construction of the Baker navigating machine. (Fig. 24.) The navigating machine is composed of a case holding a Mercator map and a transparent diagram mounted on rollers in such a manner that it may be moved over the surface of

³³ Transactions of the Royal Aeronautical Society, No. 2, London. "Position fixing in aircraft during long-distance flights over the sea," by T. Y. Baker and L. N. G. Filon.

the map. On the diagram are drawn the curves of equal altitudes and their great circle orthogonals. The westward motion of these curves is reproduced by rolling the diagram over the map, a line on the diagram being made to follow a certain parallel on the map. A time scale on the diagram can be set against some meridian on the map, thus locating the diagram in the proper position. The north and south movement of the curves due to changes in the declination of the star can not be reproduced in this manner, since the spacing and shape of the curves would alter in the Mercator projection.

A single diagram suffices for a fixed star. A number of star diagrams are placed on the same sheet, such parts as do not allow of good cuts being omitted. Thirteen diagrams are furnished for the sun, constructed at 4° intervals in declination from 24° south to 24° north. The position line is obtained by inserting the proper diagram in the machine and setting the time scale against the proper meridian. Then the curve of altitude, or the necessary portion of it, corresponding to the observed altitude is transferred to the map by the use of a bit of carbon paper. If the declination of the star differs materially from that of the diagram, which in general is the case for observations of the sun, a correction must be made. If the difference is less than 2° , a first order correction is sufficient, as the error will never be more than a minute or two. This correction is computed with the aid of a special slide rule attached to the machine.

When the St. Hilaire method is used with Mercator charts, the intercept, or the distance between the assumed or dead reckoning position and the position line, must be small in order to avoid errors due to the form of projection. About 1901 Favé³⁴ developed a method which is essentially an extension of the St. Hilaire method, the restriction being avoided by the use of the stereographic projection. A map covering about 30° of the earth's surface is employed, the central point of the map being also the center of projection. (See fig. 25.) This central point is used in place of a dead reckoning or an assumed position. Tables of altitudes and azimuths, computed for the central point, are furnished to eliminate computations by the navigator.

The map is constructed on a transparent sheet of paper or celluloid. Meridians and parallels are shown at 10-minute intervals. (Figure 25 has been simplified for clearness.) A large circle about the central point is drawn and graduated in degrees to represent azimuths. On a separate sheet are plotted the curves of equal altitude, at intervals of degrees or convenient submultiples, the curves being shown as they would be projected at the center of the map. A straight line, the azimuth index, is drawn through the centers of the arcs.

If the observed altitude is the same as the tabulated altitude for the central point, the map is placed over the curves so that the curve corresponding to the altitude passes through the central point. The map is then turned until the azimuth index passes through the proper azimuth graduation as determined by the tables. The position line is now properly located and may be traced on the map.

In the general case the observed altitude will differ from the tabular altitude, and a slightly different procedure is necessary. The map is oriented over the sheet of curves according to the tabular azimuth and so placed that the curve corresponding to the tabular altitude passes through the map center. The curve corresponding to the observed altitude would be the required position line if there were no distortion in the projection. A correction is necessary, which may be determined by means of the nomogram in Figure 26. The tabular and observed altitudes are found in the corresponding scales, and the intersection of a straight line through these points with the third scale indicates the number of the curve of position to be used. The intersection of the curve corresponding to the observed altitude and the azimuth index is traced on the map, and then the map is moved along the azimuth index until the curve found by the nomogram passes through this point. This curve is the position line sought.

Altitudes and azimuths for the fixed stars may be tabulated for the central point. Since interpolations are necessary, Favé advocates the use of so called "graphical tables." A rec-

³⁴ III^e Congrès International d'Aéronautique, Vol. 3, 1906. "Recherches * * * Détermination du Point en Ballon," by Favé.

tangular net is drawn, the vertical lines being spaced according to minutes of time on a convenient scale. Two horizontal lines are drawn for each hour of sidereal time and graduated according to altitudes and azimuths, respectively. Thus the interpolation can be made graphically, and no numbers need be written down. A single page of convenient size is sufficient.

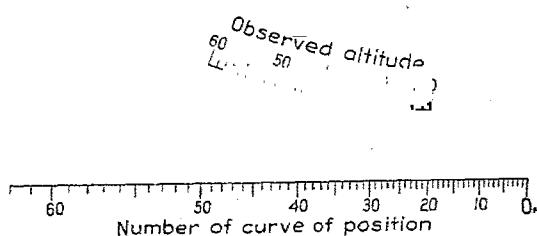
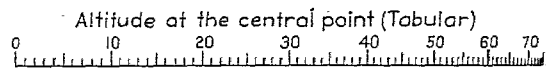
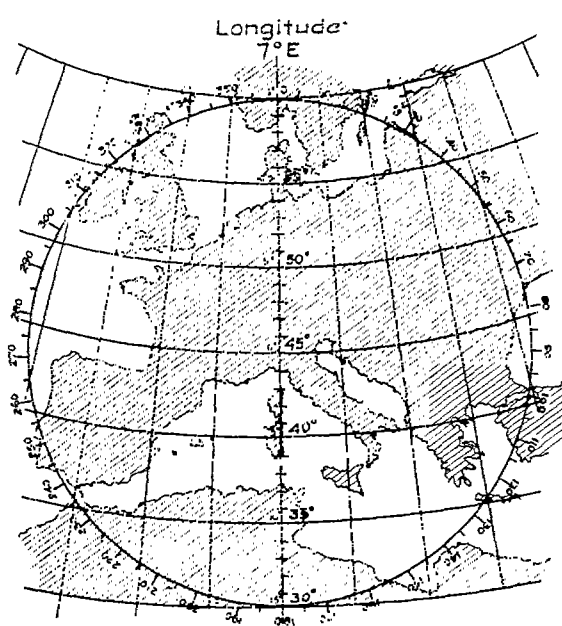

FIG. 26.—Favé nomogram



Section A-A

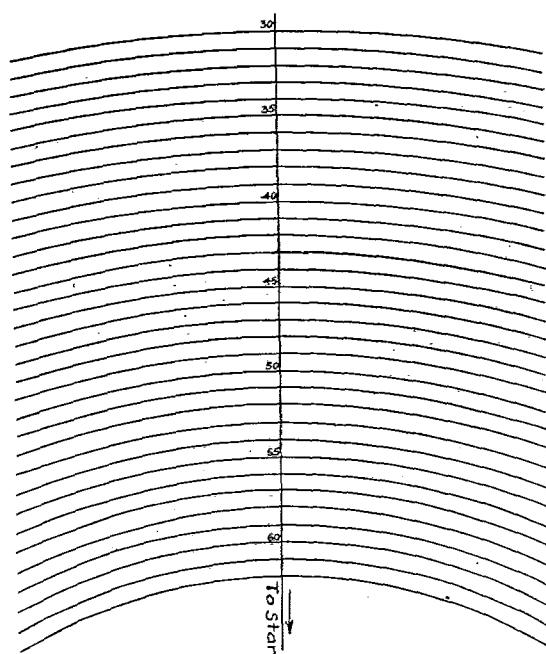

FIG. 25.—Favé chart

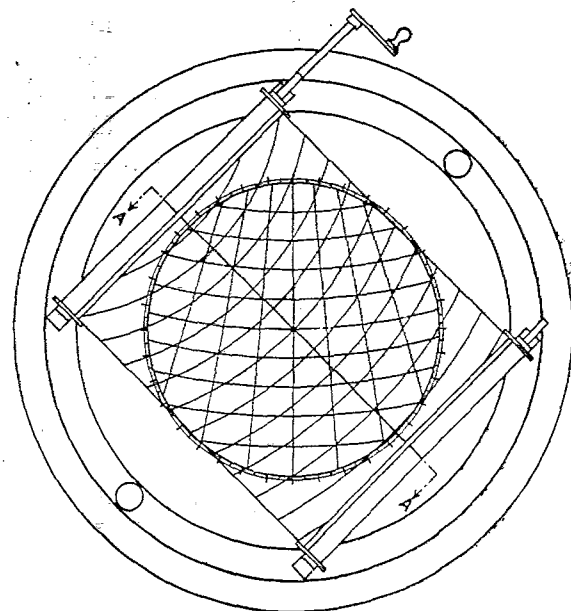

FIG. 27.—The Brill instrument

for any one star. Since the declination of the sun varies continuously, any tables of altitude and azimuth would be bulky and would require double interpolation. Therefore Favé suggests that the diagram (fig. 21) be used to determine the altitudes and azimuths of the sun and also of the moon and planets.

The map, curves, and tables may be used for any longitude provided the latitude of the central point remains unchanged. Favé recommends the use of five sets for latitudes of 0° , 30° , 45° , 75° , and 90° , respectively. Later, Favé improved his method by putting it into instrumental form. Instead of the sheet of curves, a special protractor and a curved ruler were devised by means of which the position lines could be located mechanically.

The principles of the Favé method have been utilized by Brill³⁵ in Germany in the construction of the navigating instrument shown in Figure 27. A circular map in zenithal projection covering about 10° of latitude is engraved on a sheet of transparent celluloid mounted in the frame of the instrument. Two sets of position line curves drawn on tracing linen are furnished. These are mounted, one above and the other below the map, on rollers, by means of which they may be moved across the map. The rollers are fixed to rings which can be rotated about the central point of the map, and the azimuth settings are made in this manner. Tables of altitudes and azimuths of suitable fixed stars computed for the central point of the map are given. The instrument is primarily intended for reducing the observations on fixed stars.

The Voigt³⁶ or "Orion" instrument, shown in Figure 28, was produced at the Motorluftschiff-Studien-Gesellschaft at Hamburg, in Germany. This instrument is also based on the same principles as the Favé method. The instrument consists of a rectangular metal frame, about $18\frac{1}{2}$ inches by $14\frac{1}{2}$ inches, on which is mounted the map and the mechanism for obtaining position lines. A circular map in azimuthal projection is engraved on a sheet of aluminum which is pivoted at its central point. Meridians and parallels are shown at one-half degree intervals. The central meridian is subdivided at two-minute intervals and graduated in degrees of latitude and also in degrees in both directions from the central point. A scale of azimuths is engraved around the circumference of the map, and an azimuth index fixed to the frame is provided. Three maps are furnished, each covering a latitude range of 10° , the central points being at latitudes 42° , 50° , and 55° , respectively. The position line mechanism is mounted on a bridge engaging by means of gears in two racks on the left and right hand edges of the frame. This bridge may be moved over the surface of the map and clamped in any desired position. On the bridge is a flexible metal ruler which may be set to the proper curvature by suitable gearing. The curvature for any position line is indicated by a circular scale graduated in degrees of altitude.

The procedure is rapid and simple. The altitude of a star is measured at a given time, and from the tables which are furnished the altitude and azimuth of the same star from the central point at the time of observation are found. The curvature of the ruler is adjusted by setting the altitude scale to the observed altitude. The map is set to read zero azimuth. Then the ruler is moved until its distance from the central point is equal to the difference between the observed and tabular altitudes, being north or south of the central point according as the observed altitude is less or greater than the tabular altitude. The map is rotated until the azimuth scale is set to the tabular azimuth. The ruler is now in position for drawing the position line. A similar procedure for a second star gives a second position line, and the intersection of the two is the observer's position.

The toposcope,³⁷ a recently proposed French instrument, is almost identical with that of Brill. A single sheet of curves is supplied, the curves being cut through the paper so that the position line may be marked directly on the map with a pencil.

Littlehales³⁸ of the United States Hydrographic Office has suggested the use of the American polyconic projection. At the center of the map, which may cover an extensive area, is drawn a compass diagram with radial lines to a graduated circle near the limits of the map. A series

³⁵ *Illustrierte Aeronautische Mitteilungen*, Vol. XIII, No. 22, Nov. 3, 1909. "Ein Verfahren zur Auswertung astronomische Positionsbestimmungen," by Dr. Alfred Brill

³⁶ *Zeitschrift für Flugtechnik und Motorluftschiffahrt*, Vol. II, No. 9, May 13, 1911. "Die mechanisch-graphische Lösung des Höhenproblems mit dem Voigtschen Instrument," by Hans Boykow.

³⁷ *Rapports du I^{er} Congrès International de la Navigation Aérienne*, Vol. II, Paris, December, 1921. "Le 'Toposcope,' (chercheur du Point)," by Vucetic.

³⁸ *Proceedings of the U. S. Naval Institute*, March, 1918. "The chart as a means of finding geographical position by observations of celestial bodies in aerial and marine navigation," by G. W. Littlehales.

of concentric circles spaced according to angular measure is also drawn. The difference between observed and tabular zenith distances is laid off in the proper direction and a straight line drawn perpendicular to the azimuth to represent the position line. Since the position line is in reality a curved line, there is an error due to the use of a straight line, which may reach a considerable value when the line is long, unless allowance is made for curvature. For the trans-Atlantic flight of the NC flying boats, Littlehales prepared a similar chart covering practically all of the North Atlantic Ocean.³⁹ This chart was drawn according to the Lambert zenithal projection. Tables of altitudes and azimuths and a protractor or template for drawing position lines conveniently and accurately were provided.

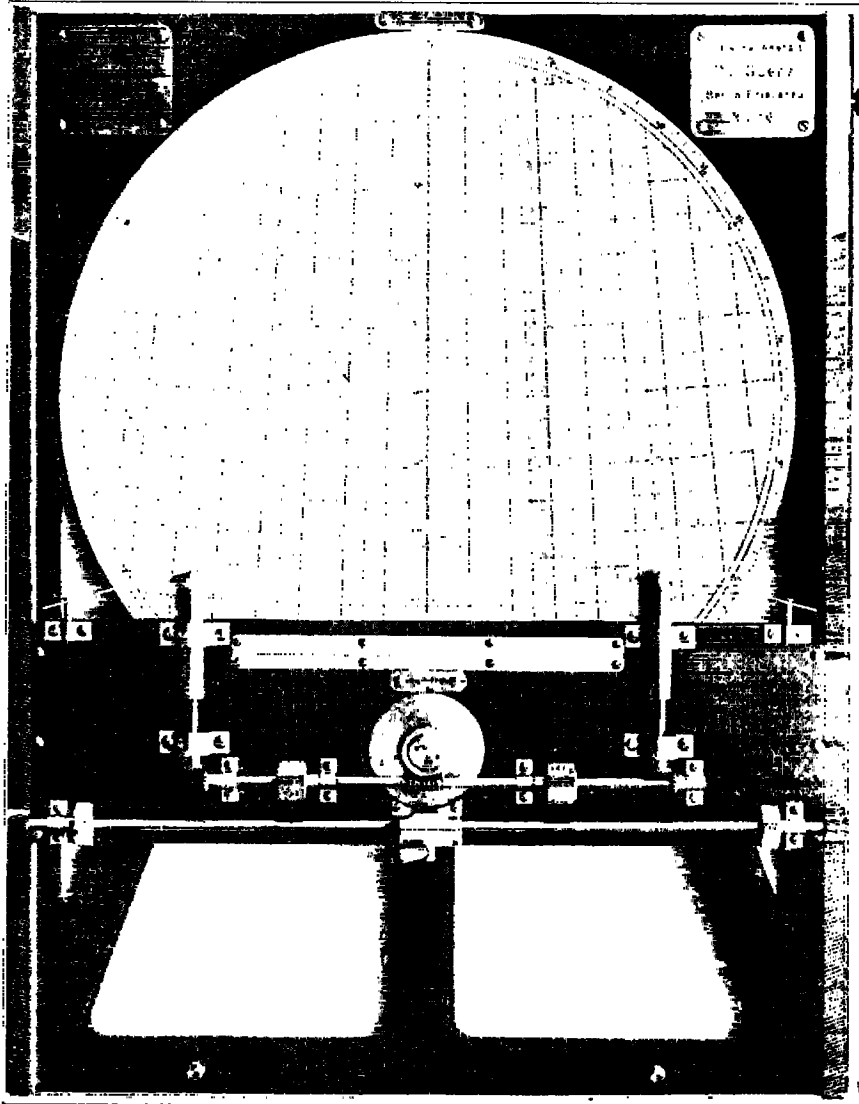

FIG. 28.—Voigt ("Orion") instrument

5. MECHANICAL SOLUTIONS

Several instruments for the mechanical solution of spherical triangles,⁴⁰ as well as a number of slide rules for calculating azimuths,⁴¹ have been devised. Most of these instruments are, for

³⁹ Aviation, July 1, 1920. "Some lessons of the trans-Atlantic flight," by Commodore H. C. Richardson, U. S. N.

⁴⁰ Wimperis and Horsley "Nomogram" Slide Rule. H. E. Wimperis, loc. cit.

⁴¹ Annalen der Hydrographie und Maritimen Meteorologie, Vol. 38, No. 10, October, 1910. "Der Azimutstab von R. Nelting," by Dr. E. Kohlschütter.

one reason or another, not suitable for the purposes of aerial navigation; and the discussion will be limited accordingly to those instruments which appear to be practicable.

The line-of-position computer ⁴² (fig. 29) was invented by Prof. Charles Lane Poor, of New York. The computer is a slide rule based on the cosine-haversine formula (Formula III, on page 28). Concentric circular scales are engraved on a metal disk about 15 inches in diameter. A circular sheet of transparent celluloid and an arm, each bearing a radial index line, are pivoted

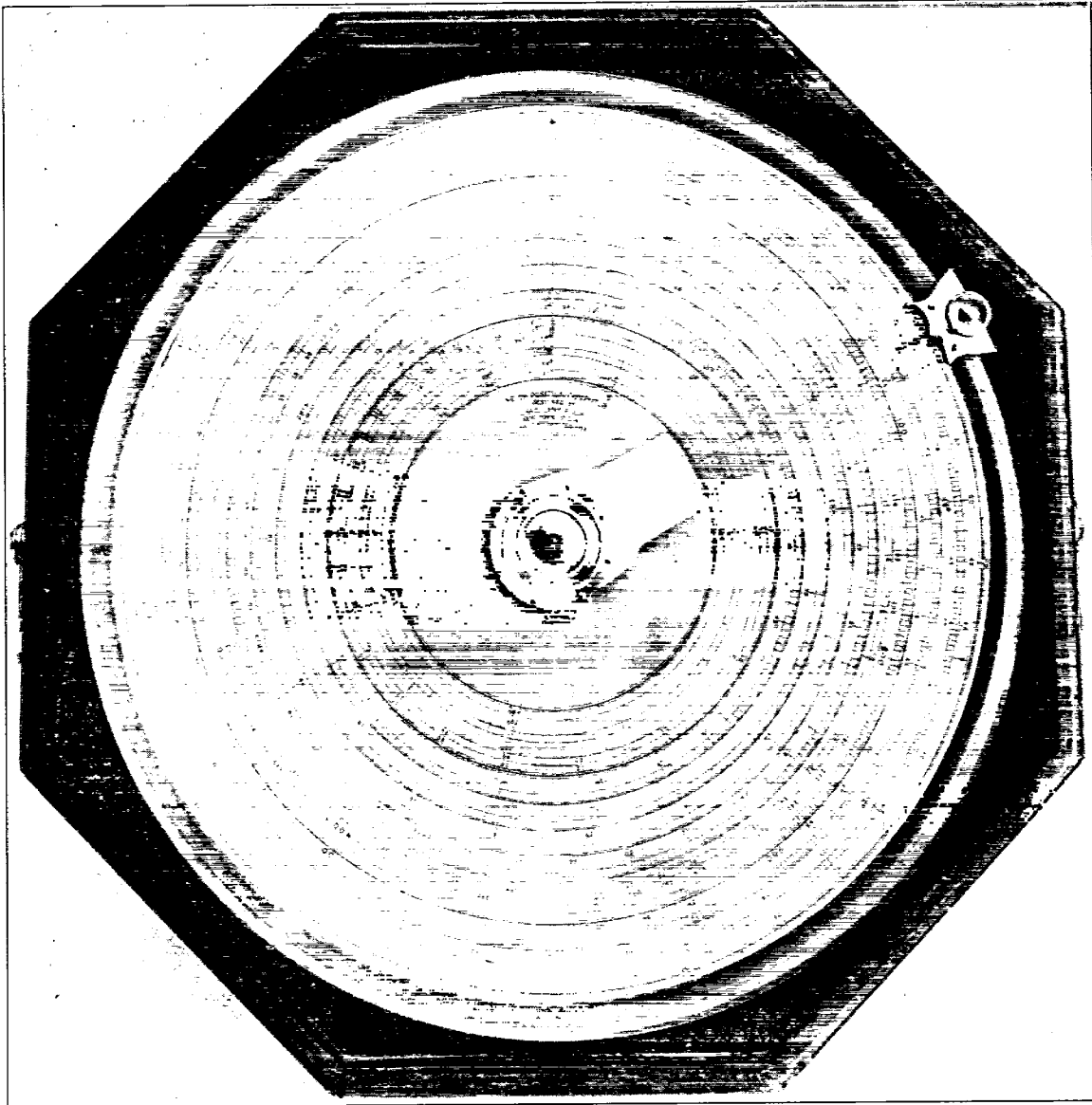

FIG. 29.—Line-of-position computer

at the center of the metal disk. The arm is furnished with a clamping screw so that it may be clamped to the celluloid sheet. There are eight graduated circles, of which the inner is used for determining azimuths and the remaining seven for determining altitudes. The altitude scale is graduated at 10' intervals, but the divisions are large enough so that single minutes may be estimated. The instrument is sufficiently accurate and rapid for aerial navigation, but the number of scales is confusing and several rules are necessary for determining the procedure to be

⁴² "Simplified Navigation," by Chas. Lane Poor. New York, 1918. The Century Co.

employed under certain conditions. It is also rather large and would be inconvenient in a restricted space.

If the astronomical triangle be divided into two right triangles, as in Figure 19, the following simple formulas may be used in solving for the altitude and azimuth:

$$\tan y = \frac{\tan d}{\cos H}$$

If l and d are the same name, $Y = (90^\circ - l) + y$.

If l and d are opposite names, $Y = (90^\circ - l) - y$.

$$\tan A = \frac{\cos y \tan H}{\cos Y}$$

$$\tan a = \cos A \tan Y,$$

where a = altitude.

A = azimuth.

l = latitude.

d = declination.

H = hour angle.

and y and Y are auxiliary angles.

The Bygrave slide rule⁴³ (fig. 30) is an English instrument which solves the astronomical triangle by the above formulas. (The notation is that used on the rule and is shown in fig. 30.) The rule consists of three concentric tubes. The inner bears a scale of logarithmic tangents, the intermediate tube a scale of logarithmic cosines, and the outer tube two pointers, one for each scale. Complete instructions are given on the instrument itself. The slide rule is about 9 inches in length and 2½ inches in diameter. An accuracy of 1' or 2' of arc is attainable in almost every case. The procedure is straightforward, simple, and rapid; and since there are but two scales, the chances for error are reduced to a minimum. The procedure must be changed when the azimuth lies between 85° and 95°, when the hour angle is less than 20' of arc, or when the declination is less than 30'. The rules for these exceptional cases are not involved and are printed on the instrument, so that no difficulties need be anticipated.

THE REDUCTION OF OBSERVATIONS ON BOARD AIRCRAFT

In marine navigation, a high degree of accuracy is essential in the reduction of astronomical observations. Other factors, however, are of equal or greater importance in aerial navigation. Since aircraft travel at great speeds, position must be fixed at

frequent intervals, at least every hour, and perhaps even more often. Also the aerial navigator must do all of the work of navigating himself, and he can spare but a few minutes of very valuable time for any one operation. Any method, therefore, which is to be of any use in aerial navigation must be rapid. The element of time is of prime importance.

Simplicity follows as a second essential. To be rapid, a method of computation must be as straightforward and direct as possible, with the number of operations reduced to a minimum. Furthermore, the same method and the same procedure should be applicable on all occasions; there is no time to choose between methods. Also the necessary equipment of maps, instruments, books of tables, and so on, must be reduced to the lowest terms.

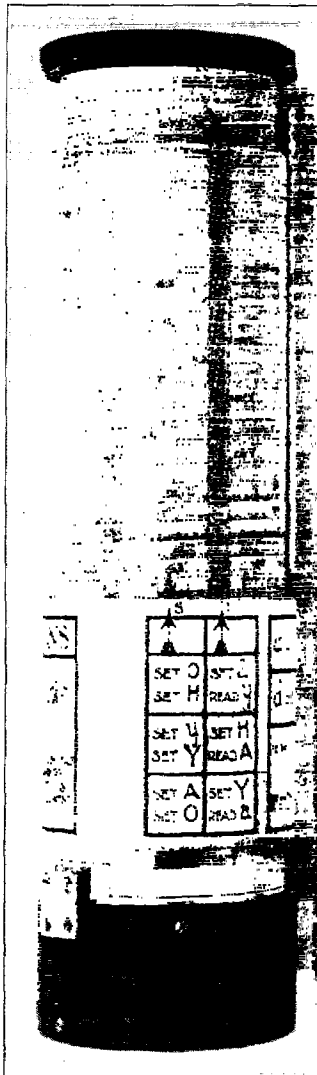

FIG. 30.—Bygrave slide-rule

⁴³The Engineer, Mar 3, 1922. "A Position Line Slide Rule."

Accuracy is required, although not to the same degree as at sea. If an observation has a possible error of 5' of arc and the reduction of the observation introduces another possible error of the same amount, the final result may be off 10'. An accuracy of 2' or 3' of arc is desirable in aerial navigation, and a higher degree of precision is warranted if the speed and simplicity of the work are not impaired.

A further requirement is that of convenience. When space and time are limited, the navigator can not handle cumbersome books of tables, inconveniently arranged and requiring interpolations for every quantity to be found. His tools, whether books, charts, or instruments, must not only be convenient in themselves but must be arranged in systematic order.

The above considerations apply most particularly to airplanes. Here the time factor is of greatest importance and the navigator works under the greatest disadvantages. Experience alone will demonstrate the most suitable method. It would seem, however, that the Bygrave slide rule is admirably adapted for the purpose, since it fulfills all the conditions of a practicable method. Printed forms for computation arranged to facilitate the work are a necessity. These forms after use may be kept as more or less permanent records of the work.

In airships, more space is available and consequently the navigator may provide himself with more equipment. It would seem that the Bygrave slide rule and printed computation forms would be advantageous for all ordinary purposes. However, supplementary methods may be provided for use on special occasions, if the value of these methods fully compensates for the added equipment required. Additional tables and the two-star diagrams, for example, may prove to be helpful.

IX. MAPS AND ACCESSORIES

The aerial navigator requires two distinct types of maps. His problem is somewhat similar to that confronting the marine navigator who has one set of charts covering rather large areas of the sea on which he lays out his route and plots his courses and position lines, and another set drawn to larger scales presenting the features of coast lines, bays, and straits, and harbors in more or less detail as may be necessary.

Thus for the purposes of piloting, or, in other words, the recognition of his position by the topographical features of the country over which he is flying, the aerial navigator employs route maps. These are usually in the form of long strips showing an area from 50 to 100 miles in width from the point of departure to the destination. The route map pictures the distinctive features of the land surface as completely as possible. On the one hand, the natural features, as rivers, lakes, coasts, and mountains, are clearly indicated, together with information regarding forests, the elevation of the ground surface, and terrain dangerous for landing. On the other, railroad lines, highways, cities, and towns, lighthouses and beacons, and landing fields of all kinds are indicated. In short, the route map must show features of the country which may aid the navigator in keeping to his course and help him to find safe landing fields for emergencies as well as those fields at which he wishes to land. The scales used vary; the most common are 1 to 200,000 and 1 to 500,000. Much work has been done with a view to the perfecting of the route map, but, although in everyday use, no generally recognized standard has as yet been produced.

For long-distance flights over the sea and over the land, in particular, regions devoid of distinctive landmarks, the route map is not sufficient in itself. General maps covering larger areas are required. These may serve several purposes; for example, by their aid the proper route may be selected; on them can be plotted the course pursued as determined by dead reckoning and the position lines found by radio bearings or astronomical observations. The route maps are not suitable for these purposes, as the areas shown are too limited, the scale is unnecessarily large, and the great amount of detail is confusing.

To be of service in the plotting of astronomical observations, the general map should have certain characteristics, and it so happens that these are convenient, if not essential, for the other uses to which the map may be put. The meridians should be straight lines, or very nearly so, in order to facilitate the plotting of azimuths. Furthermore, all great circles should be

represented by straight or nearly straight lines. This property is essential, as often the intercept between the dead reckoning or assumed position and the position line is comparatively large. Finally, all angles should be as nearly true as possible and the scale should be the same at all points of the map and in all directions. These requirements can not, of course, be realized except approximately. However, there are several forms of projection which are suitable, provided too great an area is not shown on one sheet, an example being the Lambert conformal conic projection.

The size of sheet will depend on the available space. Scales of 1 to 1,000,000 and 1 to 2,000,000 are suitable, the former being preferable for airships on which more accurate navigation is to be expected. Taking these scales for airships and airplanes, respectively, and including an extent of 10° of latitude and a corresponding extent in longitude, sheets about 44 inches and 22 inches square would be obtained. These are probably the maximum sizes which would ever be convenient, and ordinarily the area covered would have to be reduced to obtain a sheet of usable size.

The map case and plotting table are best combined in a case provided also with space for such equipment, other than observation instruments, as may be necessary in navigating. The case would consist of a shallow box hinged at one of the longer edges, each half being from 2 to 3 inches in depth and in length and breadth proportionate to the dimensions of the general map. This case should be fastened vertically in a convenient position, with the hinged side down, so that one section can be swung down toward the navigator to the horizontal, thus forming a plotting table.

When opened the horizontal section exposes the general map ready for use and, if found desirable, a parallel motion carrying protractor and straightedge (similar to the Universal drafting machine). Under the general map space may be allowed for extra maps. The vertical section may contain the Nautical Almanac and other tables, the Bygrave slide rule a pad of computation blanks, pencils, and plotting instruments, all in convenient order. Hooded lamps should be provided for night work.

The route map may be placed in the vertical section to be exposed when the case is opened or in the hinged section to show through a window when the case is closed. This form of combined navigating case and plotting table, properly arranged, can be made to fill all the requirements of navigation by dead reckoning and position finding by the radiocompass as well as by astronomical observations.

X. UTILITY AND APPLICATION OF THE ASTRONOMICAL METHOD

In order to be sure of reaching his objective the navigator must be able at all times during the flight to state his position and the direction in which to travel. Theoretically this is a simple matter; but in actual practice, especially in aviation, difficulties are continually encountered which require great skill and judgment on the part of the navigator. There is no one method of navigation which is applicable at all times and which is sufficient in itself. Each method available must be used as occasion demands. In general, navigation consists in the use of some method giving a more or less continuous record of position, supplemented by other methods furnishing independent determinations of position by means of which the results at hand may be checked or corrected. Thus the navigator proceeds by piloting or dead reckoning, checked by astronomical observations or radio bearings.

In piloting position is inferred by observations of prominent topographical features and landmarks. Even here the astronomical method may often be of great value, for the pilot may become confused and be unable to relocate himself, or the visibility may be poor and the identity of an important landmark doubtful. An incident related by Russell⁴⁴ will illustrate. "Another record of the same sort may be given in Mr. Ault's words: 'The first known instance of an airplane pilot being informed of his position by astronomical methods should be recorded here. During my flight to Washington from Langley Field, September 23, 1918, the visibility

⁴⁴ H. N. Russell, loc. cit.

was very poor. The pilot, Lieut. Charles Cleary, * * * asked if the river below was the Potomac. I had just completed drawing in position line No. 5, which intersected our track at the Potomac River, so I was able to inform him that my observations placed us at the Potomac River.' "

Dead reckoning is the fundamental method of navigation, but in aviation it is always uncertain because of the difficulties of ascertaining the true ground speed. Frequent checks and corrections are therefore necessary, and it is the function of the astronomical method to supply these. At night a complete determination of position can be made by observing two or more stars, and thus a complete check on the dead reckoning position is obtainable. During the daytime, however, only a position line can be found. But this position line will almost always give valuable information and often all that the navigator requires. Take, for example, the special case where the position line is parallel to the course of the aircraft. Then its distance from the course as laid down by dead reckoning will give the navigator an indication of the accuracy of his dead reckoning and perhaps warn him of a change in the direction or intensity of the wind. Similarly, if the position line is perpendicular to the course, the navigator can determine the approximate distance he has traveled. Indeed in this case the course plotted by dead reckoning may be regarded as a position line, and its intersection with the astronomical position line will be the most probable position of the aircraft. The nautical method of finding two position lines by observations of the sun at an interval of time sufficient to give the required azimuth difference and then shifting the first line according to the distance and direction traveled in the interim is of doubtful value in aerial navigation, and it will usually be more satisfactory to consider the position lines separately.

The astronomical position line may, of course, be combined with one found in any other manner to obtain a complete determination of position. The radio direction finder is one method which can be used this way, and it promises to be of very great value. It is already in constant use in marine navigation. At the present, however, this method has its own disadvantages and can not be said to have displaced astronomical observations. The obvious procedure is to use each method when most convenient and to supplement the other. In time of war there might be occasions when the radio would be of little use, due to interference by the enemy, and the astronomical method would then be of very great value.

XI. BIBLIOGRAPHY

1886

HORIZON GYROSCOPIQUE. Fleuriais. Revue Maritime, Dec., 1886, Jan., 1892, and Feb., 1892.

1892

ABAUQUE POUR LA DÉTERMINATION DU POINT À LA MER. Favé and Rollet de L'Isle. Annales Hydrographiques 1892. Also, Revue Maritime, Jan., 1893.

1894

ÉPHÉMÉRIDES GRAPHIQUES DONNANT LES COORDONNÉES DES ASTRES POUR LES USAGES DE LA NAVIGATION. Favé. Annales Hydrographiques, 1894.

1896

(FLEURIAIS SEXTANT.) Schwerer. Annales Hydrographiques, 1896.

1897

(BUBBLE SEXTANT CONSTRUCTED FOR ANDRÉE'S POLAR EXPEDITION, By EDV. JÄDERIN.) Kongl. Vetenskaps-Academiens Förhandlingar, Stockholm, 1897.

HORIZON GYROSCOPIQUE DANS LE VIDE DU CONTRE-AMIRAL FLEURIAIS. E. Caspari. Journal de Physique, 1897.

1899

TRAITÉ DE NOMOGRAPHIE. Maurice d'Ocagne. Paris, 1899.

DEVELOPMENT OF GREAT CIRCLE SAILING. G. W. Littlehales. U. S. Hydrographic Office, Publication No. 90, 1899.

1901

LES COURBES DE HAUTEUR. M. E. Guyou. Annales Hydrographiques, 1901.

INSTRUCTIONS COMPLIMENTAIRES POUR L'EMPLOI DE L'HORIZON GYROSCOPIQUE. FLEURIAIS. M. E. Guyou. Annales Hydrographiques, 1901.

1902

FLEURIAIS SEXTANT. U. S. Patent Specification No. 705702, 29 July, 1902.

1904

NOTICE SUR L'HORIZON GYROSCOPIQUE FLEURIAIS. Favé. Annales Hydrographiques, 1904.

NOTE SUR QUELQUES APPLICATIONS DE LA NOMOGRAPHIE À L'ASTRONOMIE NAUTIQUE. Perret. Annales Hydrographiques, 1904.

(TEST OF BUTENSCHÖN SEXTANT IN BALLOON, BAUMÉ-PLUVINEL.) Bulletin de la Société astronomique de France, Feb., 1904.

1905

(BUTENSCHÖN QUADRANT.) Ill. Aeronautische Mitteilungen, Apr., 1905.

MESSKARTE ZUR AUFLÖSUNG SPHÄRISCHER DREIECKE. Kohlschütter. Dietrich Reimer, Berlin, 1905.

HANDBUCH DER GEOGRAPHISCHEN ORTSBESTIMMUNG. A. Marcuse. F. Vierweg & Sohn, Braunschweig, 1905.

1906

ASTRONOMISCHE ORTSBESTIMMUNG IM BALLON. A. Wegener. Ill. Aeronautische Mitteilungen, Apr., 1906.

ASTRONOMISCHE ORTSBESTIMMUNGEN DES NACHTS BEI DER BALLONFAHRT VOM 5 BIS 7 APRIL, 1906. A. Wegener. Ill. Aeronautische Mitteilungen, June, 1906.

LE POINT EN BALLON. Guillaume. III^e Congrès International d'Aéronautique, Milan, 1906.

RECHERCHES SUR LES INSTRUMENTS ET LES MÉTHODES PROPRES POUR LA DÉTERMINATION DU POINT EN BALLON. Favé. III^e Congrès International d'Aéronautique, Milan, 1906.

ALTITUDE, AZIMUTH AND GEOGRAPHICAL POSITION. G. W. Littlehales. Lippincott, 1906.

1907

DIE ASTRONOMISCHE ORTSBESTIMMUNG IM BALLON UND IHRE BEDEUTUNG FÜR DIE LUFTSCHIFFFAHRT. A. Marcuse. Ill. Aeronautische Mitteilungen, Jan., 1907.

(TEST OF FLEURIAIS SEXTANT IN BALLOON, BALDIT.) L'Aérophile, June, 1907.

(REDUCTION OF OBSERVATIONS.) L'Aérophile, June, 1907.

1908

- (MIX BUBBLE SEXTANT.) L'Aérophile, May, 1908.
 ALTITUDE AND AZIMUTH TABLES FOR FACILITATING THE DETERMINATION OF LINES OF POSITION AND GEOGRAPHICAL POSITION AT SEA. R. de Aquino. Proceedings U. S. Naval Institute, 1908.
 THE AZIMUTH DIAGRAM AND ITS AVAILABILITY FOR THE SOLUTION OF VARIOUS PROBLEMS IN NAVIGATION. G. W. Logan. Proceedings U. S. Naval Institute, 1908.
 (TESTS OF FAVÉ PENDULUM SEXTANT AND MIX BUBBLE SEXTANT IN BALLOON, FAVÉ AND MIX.) L'Aérophile, Dec., 1908.

1909

- POSITION FINDING WITHOUT AN HORIZON. C. V. Boys. Nature, 22 July, 1909.
 POSITION FINDING WITHOUT AN HORIZON. C. V. Boys. Nature, 19 Aug., 1909.
 AZIMUTHSCHIEBER VON NELTING. Zeitschrift für Instrumentenkunde, Sept., 1909, and Sept., 1910.
 EINHEITLICHE METHODEN FÜR DIE ASTRONOMISCHE ORTSBESTIMMUNG IM BALLON. E. Kohlschütter. Annalen der Hydrographie und Maritimen Meteorologie, Oct., 1909.
 NEUER BEITRAG ZUR FRAGE DER ORTSBESTIMMUNG IM BALLON. A. Marcuse. Ill. Aeronautische Mitteilungen, 3 Nov., 1909.
 PRAXIS DER ORTSBESTIMMUNG IM BALLON. W. Leick. Ill. Aeronautische Mitteilungen, 3 Nov., 1909.
 DIE ASTRONOMISCHE ORTSBESTIMMUNG IM LUFTSCHIFF. J. Möller. Ill. Aeronautische Mitteilungen, 3 Nov. 1909.
 EIN VERFAHREN ZUR AUSWERTUNG ASTRONOMISCHER POSITIONS-BESTIMMUNGEN. A. Brill. Ill. Aeronautische Mitteilungen, 3 Nov. 1909. Also, Ilas-Wochenrundscha, No. 4.
 DER PEILKOMPASS IM FREIBALLON. H. H. Kritzing. Ill. Aeronautische Mitteilungen, 3 Nov. 1909.
 ÜBER DIE MAGNETISCHE ORTSBESTIMMUNG IM BALLON. Bidlingmaier. Ill. Aeronautische Mitteilungen, 3 Nov. 1909.
 WARRNEMINGEN MET DEN GYROSCOPISCHEN HORIZON FLEURIAIS. L. Roosenburg. De Zee, 1909.
 LA DETERMINATION DU POINT EN BALLON. Baumé-Pluvinel. IV^e Congrès International d'Aéronautique, Nancy, 1909.
 LES CARTES AÉRONAUTIQUES DE LA FÉDÉRATION ALLEMANDE. Moedebeck. IV^e Congrès International d'Aéronautique, Nancy, 1909.
 LES CARTES AÉRONAUTIQUES. Saunière. IV^e Congrès International d'Aéronautique, Nancy, 1909.
 ÉTUDE SUR L'ÉTABLISSEMENT DES CARTES AÉRONAUTIQUES. M. Gasser. IV^e Congrès International d'Aéronautique, Nancy, 1909.
 BESCHRIJVING EN ONDERZOEK VAN DEN GYROSCOPISCHEN HORIZON FLEURIAIS. L. Roosenburg. Korimklijk Nederlandsch Meteorologisch Institut, No. 102, Utrecht, 1909.
 ANLEITUNG ZUR ASTRONOMISCHEN ORTSBESTIMMUNG IM BALLON. A. Marcuse. G. Reimer, Berlin, 1909. Review by W. J. S. Lockyer in Nature, 29 Apr. 1909.

1910

- LE POINT SANS L'HORIZON DE LA MER. HORIZON GYROSCOPIQUE DE L'AMIRAL FLEURIAIS. Favé. Revue Maritime, Jan. 1910.
 ÜBER ORTSBESTIMMUNG BEI DER LUFTSCHIFFFAHRT. Nach Marcuse. Flug- und Motortechnik, 10 Mar. 1910.
 ÜBER ASTRONOMISCHE ORTSBESTIMMUNG IM LUFTSCHIFF. S. v. Kobbe. Annalen der Hydrographie und Maritimen Meteorologie, Mar. 1910.
 TRANSFORMATOR ZUR AUFLÖSUNG SPHÄRISCHER DREIECKE (ORTSBESTIMMUNG). Schwarzschild. Zeitschrift für Instrumentenkunde, Mar. 1910.
 BETRACHTUNGEN ÜBER HÖHENSTANDLINIEN, ETC. E. Kohlschütter. Annalen der Hydrographie und Maritimen Meteorologie, Mar. 1910.
 ASTRONOMISCHE ORTSBESTIMMUNG BEI UNBEKANNTEN LOGGEORT. R. Topp. Annalen der Hydrographie und Maritimen Meteorologie, June 1910.
 ASTRONOMISCHE ORTSBESTIMMUNG NACH HORIZONTALWINKELN. S. v. Kobbe. Annalen der Hydrographie und Maritimen Meteorologie, June 1910.
 DIE AZIMUTGLEICHEN UND DAS POTHENOTSCHES PROBLEM AUF DER KÜGEL. A. Wademeyer. Annalen der Hydrographie und Maritimen Meteorologie, Aug. 1910.
 DER AZIMUTSTAB, VON R. NELTING. Annalen der Hydrographie und Maritimen Meteorologie, Oct. 1910.
 INSTRUMENT ZUR GRAPHISCHEN DARSTELLUNG VON STANDLINIEN. O. Voigt. Annalen der Hydrographie und Maritimen Meteorologie, Nov. 1910.
 EIN PEILKOMPASS FÜR LUFTSCHIFFE. Flug- und Motortechnik, 10 Dec. 1910.
 KÜNSTLICHEN HORIZONT UND BALLONSEXTANT. Schwarzschild. Zeitschrift für Instrumentenkunde, Dec. 1910.
 EIN VERFAHREN ZUR AUSWERTUNG ASTRONOMISCHE ORTSBESTIMMUNGEN IM BALLON BEI NACHT. A. Leick. Deutsche Zeitschrift für Luftschiffahrt, 1910. Also, Annalen der Hydrographie und Maritimen Meteorologie, June 1911.

ÜBER EINE NEUE EINHEITLICHE METHODE ZUR NAUTISCHEN UND AERONAUTISCHEN ORTSBESTIMMUNG AUS GESTIRNSBEOBACHTUNGEN. A. Brill. Annalen der Hydrographie und Maritimen Meteorologie, Nov. and Dec. 1910 and Feb. 1911.

AERIAL NAVIGATION. D. S. Hatsch. Chicago, 1910.

1911

EIN BEITRAG ZUR ASTRONOMISCHEN ORTSBESTIMMUNG MIT DEM VOIGTSCHEN INSTRUMENT. W. Hormel. Deutsche Zeitschrift für Luftschiffahrt, 7 Mar. 1911.

"ORION," EIN NEUER AUSWERTUNGSAPPARAT FÜR ASTRONOMISCHE ORTSBESTIMMUNG IN DER LUFT UND AUF DER SEE. E. Wippich. Der Motorwagen, 10 Apr. 1911.

DIE ORIENTIERUNGSFRAGE. E. Wippich. Der Motorwagen, 10 April 1911.

DIE MECHANISCH-GRAPHISCHE LÖSUNG DES HÖHENPROBLEMS MIT DEM VOIGTSCHEN INSTRUMENT. Hans Boykow. Zeitschrift für Flugtechnik und Motorluftschiffahrt, 13 May 1911.

AERONAVIGATION. Hans Boykow. Oesterr. Flug-Zeitschrift, 25 July 1911.

ASTRONOMISCHE AERONAVIGATION. Oesterr. Flug-Zeitschrift, 10, 25 Aug. 1911.

INSTRUMENT ZUR GRAPHISCHEN AUSWERTUNG ASTRONOMISCHER POSITIONS-BESTIMMUNGEN NACH DER STANDLINIENMETHODE. A. Brill. Luftschiffahrt, Flugtechnik und Sport, 31 Aug. 1911. Also, Deutsche Zeitschrift für Luftschiffahrt, 23 Aug. 1911. Also, Hartmann & Braun, Frankfurt a. M., 1912.

LÖSUNG DES ZWEIHÖHENPROBLEMS IN DER KARTE. A. Wademeyer. Annalen der Hydrographie und Maritimen Meteorologie, Sept. 1911.

BEMERKUNGEN ZUR ASTRONOMISCHEN ORTSBESTIMMUNG IM LUFTFAHRZEUG. A. Marcuse. Deutsche Zeitschrift für Luftschiffahrt, 29 Nov. 1911.

HOCHSEENAVIGATION IM LUFTSCHIFF. Hans Boykow. Zeitschrift für Flugtechnik und Motorluftschiffahrt, 30 Dec. 1911.

HOHENAZIMUT-RECHENSTAB. E. Kohlschütter. Annalen der Hydrographie und Maritimen Meteorologie, Dec. 1911.

THE AERIAL AGE. Walter Wellman. A. R. Keller Co., New York, 1911.

1912

INSTRUMENT ZUR AUSWERTUNG VON GESTIRNSHÖHENBEOBACHTUNGEN IN DER KARTE. A. Wademeyer. Zeitschrift für Flugtechnik und Motorluftschiffahrt, 13 Jan. 1912.

ZUR FRAGE DER ORTSBESTIMMUNG NACH FIXSTERNEN MIT DEM LIBELLENQUADRANTEN. S. v. Kobbe. Deutsche Luftfahrer-Zeitschrift, 6 Mar. 1912.

BESTIMMUNG DER GEOGRAPHISCHEN LÄNGE AUS FIXSTERNBEOBACHTUNGEN. W. Leick. Deutsche Luftfahrer-Zeitschrift, 20 Mar. 1912.

EIN LIBELLENQUADRANT IN NEUER FORM FÜR ASTRONOMISCHE ORTSBESTIMMUNGEN. W. Lindt. Deutsche Luftfahrer-Zeitschrift, 29 May 1912. Also, Annalen der Hydrographie und Maritimen Meteorologie, Jan. 1912.

ASTRONOMISCHE ORTSBESTIMMUNGEN MIT HILFE VON NOMOGRAMMEN. W. Leick. Zeitschrift für Flugtechnik und Motorluftschiffahrt, 14 Sept. 1912.

EIN LIBELLENQUADRANT IN NEUER FORM FÜR ASTRONOMISCHE ORTSBESTIMMUNGEN (ZAHNBogen-HÖHENMESSER). E. Hartmann. Annalen der Hydrographie und Maritimen Meteorologie, Sept. 1912. Also, Deutsche Luftfahrer-Zeitschrift, 2 Oct. 1912.

ORIENTIERUNG UND NAVIGATION IM LUFTFAHRZEUG. Hans Boykow. Deutsche Luftfahrer-Zeitschrift, 24 Oct. 1912.

FAHRTBERICHT DES BALLON "BITTERFELD I." Erich Korn. Deutsche Luftfahrer-Zeitschrift, 24 Dec. 1912.

ASTRONOMISCHE ORTSBESTIMMUNGEN MIT BESONDERER BERÜCKSICHTIGUNG DER LUFTSCHIFFAHRT. W. Leick. Quelle & Mayer, Leipzig, 1912.

ÜBER EINEN NEUER KREISELKOMPASS. Th. Bruger. Jahrbuch der Wissenschaftliche Gesellschaft für Flugtechnik (bis 1914), 1., 1912-13. Berlin, 2. Lief., 1913, 125-129.

1913

LIBELLENHORIZONT UND LIBELLESEXTANT. K. Schwarzschild. Zeitschrift für Flugtechnik und Motorluftschiffahrt, 12 July 1913.

STERZEIT-TRANSFORMATOR. A. Schütze. Annalen der Hydrographie und Maritimen Meteorologie, Feb. 1913. Also, Deutsche Luftfahrer-Zeitschrift, 5 Feb. 1913.

ZUR THEORIE DES LIBELLENQUADRANTEN. H. H. Kritzinger. Deutsche Luftfahrer-Zeitschrift, 19 Feb. and 14 May 1913.

WISSENSCHAFTLICHE INSTRUMENTE. Deutsche Luftfahrer-Zeitschrift, 5 Mar. and 14 May 1913.

ÜBER DIE BESTIMMUNG DER GEOGRAPHISCHEN BREITE AUS POLARSTERNBEOBACHTUNGEN. W. Leick. Deutsche Luftfahrer-Zeitschrift, 2 Apr. 1913.

ORT- UND ZEITBESTIMMUNGEN. Grosse. Deutsche Luftfahrer-Zeitschrift, 14 May 1913.

ÄUSSERUNG ZU DEM AUFSATZ DES HERRN DR. H. H. KRITZINGER "ZUR THEORIE DES LIBELLENQUADRANTEN." S. v. Kobbe. Deutsche Luftfahrer-Zeitschrift, 14 May 1913.

BERICHT ÜBER ASTRONOMISCHE UND MAGNETISCHE ORTSBESTIMMUNGS-VERSUCHE AN BORD DES LUFTSCHIFFES "HANSA." J. Möller. Mitteilungen des Luftschiffbau Zeppelin IX, Zeitschrift für Flugtechnik und Motorluftschiffahrt, 27 Sept. 1913.

EINE AUSSTELLUNG VON MESSAPPARATEN. H. Wachsmuth. Jahrbuch der Wissenschaftliche Gesellschaft für Flugtechnik, 1913.

TAFELN ZUR ASTRONOMISCHEN ORTSBESTIMMUNG MIT EINER STERNKARTE. A. Kohlschütter. 1913.

1914

CONDENSATION OF THE TABLES OF THE AZIMUTH OF CELESTIAL BODIES. G. W. Littlehales. Journal Washington Academy of Sciences, 4 Oct. 1914.

A SPECIAL METHOD OF FINDING THE SUMNER LINE. G. W. Littlehales. Journal Washington Academy of Sciences, 4 Nov. 1914.

GYROSTATS AND GYROSTATIC ACTION. Andrew Gray. Smithsonian Report for 1914.

REPORT ON GYROSCOPIC THEORY. Greenhill. Advisory Committee for Aeronautics (Br.), Reports and Memos. No. 146, 1914.

1916

BEHAVIOR OF LEVELS WHEN SUBJECT TO VIBRATION. A. Mallock. Advisory Committee for Aeronautics (Br.). Report 1916-17.

1917

FINDING THE AZIMUTH FOR DETERMINING THE SUMNER LINE. G. W. Littlehales. Proceedings U. S. Naval Institute, Apr. 1917.

ALTITUDE, AZIMUTH, AND HOUR ANGLE DIAGRAM. G. W. Littlehales. Proceedings U. S. Naval Institute, Nov. 1917.

AIR NAVIGATION FOR FLIGHT OFFICERS. A. E. Dixie. London, 1917.

1918

DIAGRAM FOR GRAPHICAL CORRECTION TO BE APPLIED TO EX-MERIDIAN ALTITUDES. Comdr. E. B. Fenner. Proceedings U. S. Naval Institute, Jan. 1918.

THE CHART AS A MEANS OF FINDING GEOGRAPHICAL POSITION BY OBSERVATIONS OF CELESTIAL BODIES IN AERIAL AND MARINE NAVIGATION. G. W. Littlehales. Proceedings U. S. Naval Institute, Mar. 1918.

A NEW METHOD OF USING ALTITUDE AND AZIMUTH TABLES TO OBTAIN A SHIP'S POSITION AT SEA. Lieut. A. B. Clements. Proceedings U. S. Naval Institute, 1918.

THE SEARCH FOR INSTRUMENTAL MEANS TO ENABLE NAVIGATORS TO OBSERVE THE ALTITUDE OF A CELESTIAL BODY WHEN THE HORIZON IS NOT VISIBLE. G. W. Littlehales. Proceedings U. S. Naval Institute, Aug. 1918.

CAPT. WEIR'S AZIMUTH DIAGRAM. Lieut. E. R. McClung. Proceedings U. S. Naval Institute, 1918.

AN INTERPOLATING INSTRUMENT TO EXPEDITE THE USE OF AQUINO'S TABLES IN NAVIGATION. Lieut. A. Forbes. Proceedings U. S. Naval Institute, 1918.

THE NEW UTMARK CHART. Proceedings U. S. Naval Institute, 1918.

ALTITUDE OR POSITION LINE TABLES. Frederick Ball. J. D. Potter, London. (In 3 volumes.)

AZIMUTHS OF THE SUN. U. S. Hydrographic Office, Publication No. 71, 1918.

ALTITUDE, AZIMUTH, AND LINE OF POSITION TABLES. U. S. Hydrographic Office, Publication No. 200, 1918.

SIMPLIFIED NAVIGATION FOR SHIPS AND AIRCRAFT. Charles Lane Poor. Century Co., New York, 1918.

GYROSTATICS AND ROTATIONAL MOTION. Andrew Gray. MacMillan & Co., Ltd., London, 1918.

PRACTICAL TABLES FOR NAVIGATORS AND AVIATORS. Armistead Rust. Philadelphia, 1918.

NAVIGATION UND SEEMANSCHAFT IM SEEFLUGZEUG. Th. E. Sönnichson. R. C. Schmidt & Co., Berlin, 1918.

MAP READING FOR AVIATORS. Chas. B. Benson. New York, 1918.

1919

ZUR STÖRUNGSTHEORIE DES KREISELPENDELS. R. Gammel. Zeitschrift für Flugtechnik und Motor Luftschiffahrt, 25 Jan. 1919.

SUL PROBLEMA DELL' ORIENTAMENTO—UN NUOVO DIAGRAMMA AZIMUTALE. L'Aeronauta, Jan. 1919.

LIBELLENQUADRANT MIT SCHNELLABLESUNG. Zeitschrift für Feinmechanik, 5 May, 1919.

BEMERKUNGEN ZUM ARTIKEL: ZUR STÖRUNGSTHEORIE DES KREISELPENDELS VON R. GAMMEL. Hans Boykow.

ERWIDERUNG DAZU. R. Gammel. Zeitschrift für Flugtechnik und Motorluftschiffahrt, 28 June, 1919.

REPORT ON THE NAVIGATION OF AIRCRAFT BY SEXTANT OBSERVATIONS. H. N. Russell. Proceedings of the Astronomical Society of the Pacific, June, 1919.

THE BAKER AIR SEXTANT. T. Y. Baker. Transactions of the Optical Society (London), June, 1919.

AIR NAVIGATION. H. E. Wimperis. Aeronautical Journal, Aug., 1919 (with discussion). Also, Aeronautics, 8 May, 1919. Also, Flight, 8 May, 1919.

GENERAL METHODS OF AERIAL NAVIGATION. Thierry. Lecture, French Aerial Navigation Society 17 Dec., 1919.

- AIR NAVIGATION, NOTES AND EXAMPLES. S. F. Card. Edw. Arnold, London, 1919.
 AMERICAN PRACTICAL NAVIGATOR—BOWDITCH. U. S. Hydrographic Office.
 SIMULTANEOUS ALTITUDES AND AZIMUTHS OF CELESTIAL BODIES. U. S. Hydrographic Office, Publication No. 201, 1919.

1920

- (FRENCH GYRO-SEXTANT.) The Aeroplane, 21 Jan., 1920.
 AU SALON DE L'AÉRONAUTIQUE. L'Aéronautique, Jan., 1920.
 THE GYROSCOPIC COMPASS: A NON-MATHEMATICAL TREATMENT. The Engineer, 16 Jan. to 5 Mar., 1920.
 POSITION FIXING IN AIRCRAFT DURING LONG DISTANCE FLIGHTS OVER THE SEA. T. Y. Baker and L. N. G. Filon. Transactions of the Royal Aeronautical Society, London, Mar., 1920.
 HOW AIRMEN FIND THEIR WAY. H. E. Wimperis. Aeronautical Journal, Mar., 1920. Also, The Aeroplane, 14 Apr., 1920 (extracts).
 BAKER SEXTANT. U. S. Patent Specification No. 1337912, 20 Apr., 1920.
 NAVIGATIONAL REPORTS ON CERTAIN TRANS-ATLANTIC AND AFRICAN FLIGHTS IN 1919-20. Advisory Committee for Aeronautics (Br.), Apr., 1920.
 FORCED VIBRATIONS IN AEROPLANE INSTRUMENTS. H. E. Wimperis. Aeronautical Research Committee (Br.), Reports and Memos. No. 685, Apr., 1920.
 AERIAL NAVIGATION INSTRUCTIONS (PROVISIONAL). Air Service Information Circular Vol. 1, No. 82, 15 June, 1920.
 LES DOCUMENTS AÉRONAUTIQUES. Thierry. L'Aéronautique, June, 1920.
 SOME LESSONS OF THE TRANSATLANTIC FLIGHT. Comdr. H. C. Richardson. Aviation, 1 July, 1920.
 REPORT ON 1,000 MILE "HANDLEY PAGE" NAVIGATION FLIGHT. Instrument Design Establishment Royal Air Force, Aeronautical Research Committee (Br.), Sept., 1920.
 SOME TESTS ON NAVIGATION INSTRUMENTS DURING A FLIGHT OF RIGID AIRSHIP H. M. A. R-33. L. C. Bygrave. Aeronautical Research Committee (Br.), Reports and Memos. No. 702, Sept., 1920.
 T. S. F. ET NAVIGATION AÉRIENNE. Denielou. L'Aéronautique, Nov., 1920.
 DESIGN OF INSTRUMENTS FOR THE NAVIGATION OF AIRCRAFT. G. M. B. Dobson. Geographical Journal (London), Nov., 1920.
 THE PROSPECTIVE UTILIZATION OF VESSEL-TO-SHORE RADIO-COMPASS BEARINGS IN AERIAL AND TRANS-OCEANIC NAVIGATION. G. W. Littlehales. Journal of the American Society of Naval Engineers, 1920.
 AZIMUTHS OF CELESTIAL BODIES. U. S. Hydrographic Office, Publication No. 120, 1920.
 OUR ATLANTIC ATTEMPT. Grieve, 1920.
 A PRIMER OF AIR NAVIGATION. H. E. Wimperis. Constable & Co., Ltd., London, 1920.
 PRINCIPALS AND PRACTICE OF AERIAL NAVIGATION. J. E. Dumbleton. Crosby, Lockwood & Son, London, 1920.
 FLYING THE ATLANTIC IN SIXTEEN HOURS. Sir Arthur Whitten Brown. Frederick A. Stokes Co., New York, 1920.
 TRAITÉ PRATIQUE DE LA NAVIGATION AÉRIENNE. Hébrard and Duval. L'Aéronautique, 1920-21.

1921

- GRAPHIQUES POUR LA DÉTERMINATION DES ROUTES ORTHODROMIQUES SUR LA PROJECTION DE MERCATOR Favé. Compte-rendus de l'Académie des Sciences, 31 Jan., 1921.
 AIRSHIP PILOTING. G. H. Scott. Aeronautical Journal, Feb., 1921 (with discussion). Also, Aeronautics, 9 Dec., 1920.
 POSITION PLOTTING BY RADIO BEARINGS. E. B. Collins. Proceedings U. S. Naval Institute, Feb., 1921.
 TABLE À CARTE ET PORTE-CARTE. L'Aéronautique, Mar., 1921.
 AIR NAVIGATION INSTRUMENTS. Air Ministry, Directorate of Research, Air Publication 803, Apr., 1921.
 FISCHER SEXTANT. U. S. Patent Specifications No. 1376327, 26 Apr., 1921, No. 1386695, 9 Aug., 1921, and No. 1409938, 21 Mar. 1922.
 ANSCHÜTZ ARTIFICIAL HORIZON. A. Gradenwitz. Aeronautics, 2 June, 1921.
 NUOVA NAVIGAZIONE; ASTRONOMICA—LE RETTE DI POSIZIONE—TEORIA—APPLICAZIONE—TAVOLE. G. Pes. Review in Nature, Aug. 18, 1921.
 LES CARTES ET LES REPÈRES AÉRONAUTIQUES INTERNATIONAUX. Blondel la Rougery. Premier Congrès International de la Navigation Aérienne, Paris, Nov., 1921, tome 2, Rapports, p. 119.
 EFFECT OF TEMPERATURE AND PRESSURE ON WATCHES AND CHRONOMETERS. M. Leroy. Premier Congrès International de la Navigation Aérienne, Paris, Nov., 1921.
 (TESTS WITH FAVÉ SEXTANT ON DIRIGIBLES—CAPT. LAGNEAU). Premier Congrès International de la Navigation Aérienne, Paris, Nov., 1921, tome 3, pp. 328-329.
 APPAREILS PERMETTANT DE REPÉRAGE DE LA POSITION D'UN AÉRONEF. Volmerange. Rapports du Premier Congrès International de la Navigation Aérienne, Vol. I, Paris, Nov., 1921.
 LE "TOPOSCOPE" (CHERCHEUR DU POINT). Vucetic. Rapports du Premier Congrès International de la Navigation Aérienne, Vol. II, Paris, Nov., 1921.

NAVIGATIONAL FLIGHTS AND TESTS OF NAVIGATING INSTRUMENTS. Aeronautical Research Committee (Br.), Report for 1920-21, and supplement to the report for the year 1920-21.

NAVIGATIE IN Vliegtuigen. Luit. J. S. C. Olivier. Marineblad, 3, afev., 1921.

1922

METHODS OF AIR NAVIGATION. Herbert V. Thaden. Aviation, 27 Feb., 1922.

A POSITION LINE SLIDE RULE. The Engineer, 3 Mar., 1922.

MAPS AND NAVIGATION METHODS. A. Duval. Aerial Age Weekly, 8 May, 1922. (Translated from Premier Congrès International de la Navigation Aérienne, Paris, Nov., 1921, pp. 150-155.)

LE RAID—DE LISBONNE AU ROCHER DE STE. PAUL, COUTINHO ET SACADURA. L'Aérophile, 15 May, 1922.

GENERAL CLASSIFICATION OF INSTRUMENTS AND PROBLEMS INCLUDING BIBLIOGRAPHY. M. D. Hersey. National Advisory Committee for Aeronautics, Report No. 125, 1922.

ON THE APPLICATION OF THE GYROSCOPE TO THE SOLUTION OF THE "VERTICAL" PROBLEM OF AIRCRAFT. J. G. Gray. Proceedings Royal Society of Edinburgh, vol. 42, 1921-22, pp. 257-317.

AERIAL NAVIGATION AND NAVIGATING INSTRUMENTS. H. N. Eaton. National Advisory Committee for Aeronautics, Report No. 131, 1922.

1923

THE PROGRESS OF RESEARCH AND EXPERIMENT. W. G. H. Salmond. Third Air Conference, London, Feb. 1923. (Abstract in Flight, 23 Feb., 1923.)

AERONAUTIC INSTRUMENTS. F. L. Hunt. Bureau of Standards, Technologic Papers, No. 237, 16 May, 1923.

L'EMPLOI DES MÉTHODES DE NAVIGATION EST INDISPENSABLE AU SUCCÈS DES TRANSPORTS AÉRIENS COMMERCIAUX. A. B. Duval. International Air Congress, London, June, 1923.

LA NAVIGATION AÉRIENNE EN FRANCE. Volmerange. International Air Congress, London, June, 1923.

NAVIGATION EQUIPMENT FOR LONG-DISTANCE FLIGHTS. H. E. Wimperis. International Air Congress, London, June, 1923.

LA MÉTHODE DE NAVIGATION DE L'AMIRAL GAGO COUTINHO. Lecointe. L'Aérophile, 1-15 June and 1-15 July, 1923.

A NOVEL INSTRUMENT FOR NAVIGATORS. Scientific American, Sept., 1923, p. 173.

AERIAL NAVIGATION. A. P. Rowe. Journal of the Royal Aeronautical Society, Sept., 1923.

THE SUMNER LINE OF POSITION FURNISHED READY TO LAY DOWN UPON THE CHART BY MEANS OF TABLES OF SIMULTANEOUS HOUR ANGLE AND AZIMUTH OF CELESTIAL BODIES. U. S. Hydrographic Office, Publication No. 203, 1923.

1924

SOME RECENT DEVELOPMENTS IN AIRCRAFT INSTRUMENTS. H. E. Wimperis. Journal of the Royal Aeronautical Society, Jan., 1924.

ALTITUDE AND AZIMUTH TABLES. Radler de Aquino. Brazilian Centenary Edition, J. D. Potter, London, 1924.