

Pub. No. 9

AMERICAN PRACTICAL NAVIGATOR

AN EPITOME OF NAVIGATION

ORIGINALLY BY

NATHANIEL BOWDITCH, LL.D.

VOLUME I



2017 EDITION

Prepared and published by the
NATIONAL GEOSPATIAL-INTELLIGENCE AGENCY
Springfield, Virginia

© COPYRIGHT 2017 BY THE NATIONAL GEOSPATIAL-INTELLIGENCE AGENCY
NO DOMESTIC COPYRIGHT CLAIMED UNDER TITLE 17 U.S.C. ALL RIGHTS RESERVED.

CERTAIN SECTIONS ARE SUBJECT TO THIRD PARTY PROTECTION.



NSN 7642014014652

NGA REF. NO. NVPUB9V1

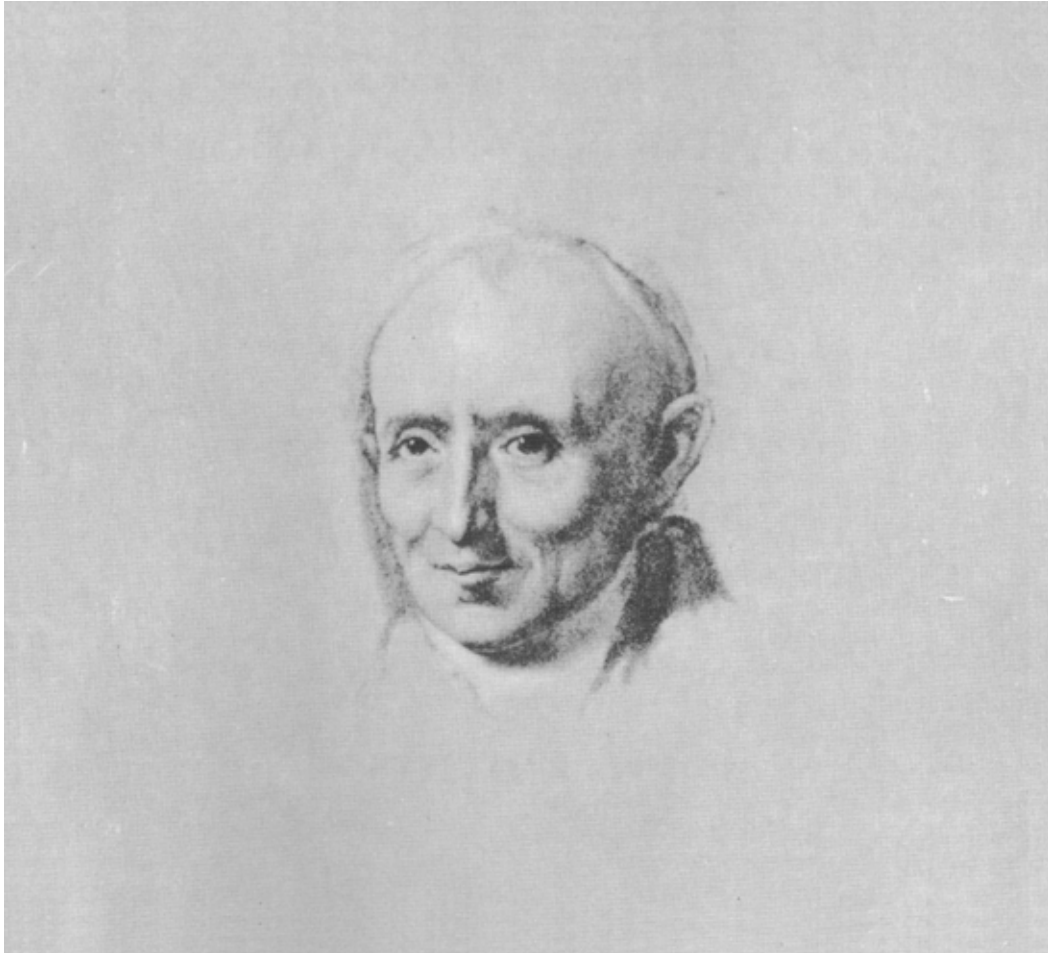

Last painting by Gilbert Stuart (1828). Considered by the family of Bowditch to be the best of various paintings made, although it was unfinished when the artist died.

FORWARD

I am honored to welcome you to the 2017 edition of *Publication No. 9, The American Practical Navigator*, or as most mariners refer to it, “Bowditch.” As a young Surface Warfare Officer serving in my first ship, I quickly learned Bowditch should be my first resource for all things related to navigation, oceanography and meteorology. I never imagined that 25 years later, I would be privileged to lead the team entrusted with updating this incredible document.

One can hardly imagine the time, effort, and pressure involved in undertaking such a task--this is *Bowditch*, after all. None of us alone can equal the talent, experience and skill of Nathaniel Bowditch, as expressed in his first edition of 1802. As a result, this edition is the outcome of countless hours of hard work by many dedicated, passionate, and skilled colleagues from a variety of disciplines. And it was this team of scientific and operational navigation experts, led by Dr. Jerry Clifford, which has created this contemporary edition that stands ready to address the challenges faced by today's navigators and mariners. Please take the time to read the long list of contributors to this edition, I know you will be impressed by the depth and quality of our team.

Since the last edition, there have been huge advancements in positioning methodologies and navigation systems. In some cases, what was old is new again, so we focused considerable effort into improving the celestial

navigation and piloting chapters. Hand-plotting latent fixes on paper charts has been overtaken by Electronic Chart Display and Information Systems that continuously tell you where you are, provide warnings when standing into danger, and display radar and Automatic Identification System information to heighten situational awareness. Older graphics have been replaced by newer, higher resolution images to better illustrate the purpose of the text. And, we have tried to make this document more accessible by creating it in an electronic format which allows easier updating and online publication.

I do understand the desire for a hard copy *Bowditch*, but publishing costs have served to actually decrease our ability to include all of the information we wanted to make available to the mariner (this electronic version has 2 full volumes!). Needless to say, we are justifiably proud of this 2017 edition and equally honored to continue such a noteworthy legacy of the navigational expertise first introduced by Nathaniel Bowditch 215 years ago. Wherever you may sail, I trust this fine resource will assure your safe passage. I wish you all fair winds and following seas.

CAPT Brian D. Connon, United States Navy
Director, Maritime Safety Office
National Geospatial-Intelligence Agency
Springfield, Virginia

NATHANIEL BOWDITCH

(1773-1838)

Nathaniel Bowditch was born on March 26, 1773, in Salem, Massachusetts, fourth of the seven children of shipmaster Habakkuk Bowditch and his wife, Mary.

From the time William Bowditch migrated from England in the 17th century, the Bowditch family resided in Salem. Most of its sons, like those of other families in this New England seaport, had gone to sea, and many of them became shipmasters. Nathaniel Bowditch himself sailed as master on his last voyage, and two of his brothers met untimely deaths while pursuing careers at sea.

Nathaniel Bowditch's father, Habakkuk, was said to have lost two ships at sea, and by late Revolutionary days he was forced to return to the cooper trade that he had learned in his youth. Although cooper products such as the cask and barrel containers used for shipping flour, gunpowder, tobacco and liquids were in very high demand, this work delivered an insufficient income to properly provide for the needs of this growing family, who were often hungry and cold.

For many years the nearly destitute family received an annual grant of 15 to 20 dollars from the Salem Marine Society. By the time Nathaniel had reached the age of 10, the family's poverty forced him to leave school and join his father in the cooperage trade to help support the family.

Nathaniel was unsuccessful as a cooper, and when he was about 12 years of age, he entered the first of two shipchandlery firms by which he was employed. It was during the nearly 10 years he was so employed that his great mind first attracted public attention. From the time he began school, Bowditch had an all-consuming interest in learning, particularly mathematics. By his middle teens he was recognized in Salem as an authority on that subject. Salem being primarily a shipping town, most of the inhabitants sooner or later found their way to the ship chandler, and news of the brilliant young clerk spread until eventually it came to the attention of the learned men of his day. Impressed by his desire to educate himself, they supplied him with books that he might learn of the discoveries of other men. Since many of the best books were written by Europeans, Bowditch first taught himself their languages, learning French, Spanish, Latin, Greek and German which were among the two dozen or more languages and dialects he studied during his life. At the age of 16 he began the study of Newton's *Principia*, translating parts of it from the Latin. He even found an error in that classic text, and though lacking the confidence to announce it at the time, he later published findings that were accepted by the scientific community.

During the Revolutionary War, a privateer out of Beverly, a neighboring town to Salem, had taken as one of its prizes an

English vessel which was carrying the philosophical library of a famed Irish scholar, Dr. Richard Kirwan. The books were brought to the Colonies and there bought by a group of educated Salem men who used them to found the Philosophical Library Company, reputed to have been the best library north of Philadelphia at the time. In 1791, when Bowditch was 18, two Harvard-educated ministers, Rev. John Prince and Rev. William Bentley, persuaded the Company to allow Bowditch the use of its library. Encouraged by these two men and a third, Nathan Read, an apothecary who was also a Harvard man, Bowditch studied the works of the great men who had preceded him, especially the mathematicians and the astronomers. By the time he reached adulthood, this knowledge, acquired when not working long hours at the chandlery, had made young Nathaniel the outstanding mathematician in the Commonwealth, and perhaps even the country.

In the seafaring town of Salem, Bowditch was drawn to navigation early, learning the subject at the age of 13 from an old British sailor. A year later he began studying surveying, and in 1794 he assisted in a survey of the town. At 15 he devised an almanac reputed to have been of great accuracy. His other youthful accomplishments included the construction of a crude barometer and a sundial.

When Bowditch went to sea at the age of 21, it was as captain's writer and nominal second mate, the officer's berth being offered him because of his reputation as a scholar. Under Captain Henry Prince, the ship *Henry* sailed from Salem in the winter of 1795 on what was to be a year-long voyage to the Ile de Bourbon (now called Reunion) in the Indian Ocean.

Bowditch began his seagoing career when accurate time was not available to the average naval or merchant ship. A reliable marine chronometer had been invented some 60 years before, but the prohibitive cost, plus the long voyages without opportunity to check the error of the timepiece, made the large investment impractical. A system of determining longitude by "lunar distance," a method which did not require an accurate timepiece, was known, but this product of the minds of mathematicians and astronomers was so involved as to be beyond the capabilities of the uneducated seamen of that day. Consequently, ships were navigated by a combination of dead reckoning and parallel sailing (a system of sailing north or south to the latitude of the destination and then east or west to the destination). The navigational routine of the time was "lead, log, and lookout."

To Bowditch, the mathematical genius, computation of lunar distances was no mystery, of course, but he recognized the need for an easier method of working them in order to navigate ships more safely and efficiently.

Through analysis and observation, he derived a new and simplified formula during his first voyage.

John Hamilton Moore's *The Practical Navigator* was the leading navigational text when Bowditch first went to sea, and had been for many years. Early in his first voyage, however, the captain's writer-second mate began turning up errors in Moore's book, and before long he found it necessary to recompute some of the tables he most often used in working his sights. Bowditch recorded the errors he found, and by the end of his second voyage, made in the higher capacity of supercargo, the news of his findings in *The New Practical Navigator* had reached Edmund Blunt, a printer at Newburyport, Mass. At Blunt's request, Bowditch agreed to participate with other learned men in the preparation of an American edition of the thirteenth (1798) edition of Moore's work. The first American edition was published at Newburyport by Blunt in 1799. This edition corrected many of the errors that Moore had introduced.

Although most of the errors were of little significance to practical navigation because they were errors in the fifth and sixth places of logarithm tables, some errors were significant. The most significant mistake was listing the year 1800 as a leap year in the table of the sun's declination. The consequence was that Moore gave the declination for March 1, 1800, as $7^{\circ}11'$. Since the actual value was $7^{\circ}33'$, the calculation of a meridian altitude would be in error by 22 minutes of latitude, or 22 nautical miles. This infamous mathematical error would result in loss of life and at least two vessels, and contributed to numerous other hazardous situations. An outcome that Bowditch personally considered to be criminal.

Bowditch's principal contribution to the first American edition was his chapter "The Method of Finding the Longitude at Sea," which discussed his new method for computing lunar distances. Following publication of the first American edition, Blunt obtained Bowditch's services in checking the American and English editions for further errors. Blunt then published a second American edition of Moore's thirteenth edition in 1800. When preparing a third American edition for the press, Blunt decided that Bowditch had revised Moore's work to such an extent that Bowditch should be named as author. The title was changed to *The New American Practical Navigator* and the book was published in 1802 as a first edition. Bowditch vowed while writing this edition to "put down in the book nothing I can't teach the crew," and it is said that every member of his crew including the cook could take a lunar observation and plot the ship's position.

Bowditch made a total of five trips to sea, over a period of about nine years, his last as master and part owner of the three-masted *Putnam*. Homeward bound from a 13-month voyage to Sumatra and the Ile de France (now called Mauritius), the *Putnam* approached Salem harbor on December 25, 1803, during a thick fog without having had a celestial observation since noon on the 24th. Relying upon

his dead reckoning, Bowditch conned his wooden-hulled ship to the entrance of the rocky harbor, where he had the good fortune to get a momentary glimpse of Eastern Point, Cape Ann, enough to confirm his position. The *Putnam* proceeded in, past such hazards as "Bowditch's Ledge" (named after a great-grandfather who had wrecked his ship on the rock more than a century before) and anchored safely at 1900 that evening. Word of the daring feat, performed when other masters were hove-to outside the harbor, spread along the coast and added greatly to Bowditch's reputation. He was, indeed, the "practical navigator."

His standing as a mathematician and successful shipmaster earned him a well-paid position ashore within a matter of weeks after his last voyage. He was installed as president of a Salem fire and marine insurance company at the age of 30, and during the 20 years he held that position the company prospered. In 1823 he left Salem to take a similar position with a Boston insurance firm, serving that company with equal success until his death.

From the time he finished the "*Navigator*" until 1814, Bowditch's mathematical and scientific pursuits consisted of studies and papers on the orbits of comets, applications of Napier's rules, magnetic variation, eclipses, calculations on tides, and the charting of Salem harbor. In that year, however, he turned to what he considered the greatest work of his life, the translation into English of *Mecanique Celeste*, by Pierre Laplace. *Mecanique Celeste* was a summary of all the then known facts about the workings of the heavens. Bowditch translated four of the five volumes before his death, and published them at his own expense. He gave many formula derivations which Laplace had not shown, and also included further discoveries following the time of publication. His work made this information available to American astronomers and enabled them to pursue their studies on the basis of that which was already known. Continuing his style of writing for the learner, Bowditch presented his English version of *Mecanique Celeste* in such a manner that the student of mathematics could easily trace the steps involved in reaching the most complicated conclusions.

Shortly after the publication of *The New American Practical Navigator*, Harvard College honored its author with the presentation of the honorary degree of Master of Arts, and in 1816 the college made him an honorary Doctor of Laws. From the time the Harvard graduates of Salem first assisted him in his studies, Bowditch had a great interest in that college, and in 1810 he was elected one of its Overseers, a position he held until 1826, when he was elected to the Corporation. During 1826-27 he was the leader of a small group of men who saved the school from financial disaster by forcing necessary economies on the college's reluctant president. At one time Bowditch was offered a Professorship in Mathematics at Harvard but this, as well as similar offers from West Point and the University of Virginia, he declined. In all his life he was never known to have made a public speech or to have addressed any large group of people.

Many other honors came to Bowditch in recognition of his astronomical, mathematical, and marine accomplishments. He became a member of the American Academy of Arts and Sciences, the East India Marine Society, the Royal Academy of Edinburgh, the Royal Society of London, the Royal Irish Academy, the American Philosophical Society, the Connecticut Academy of Arts and Sciences, the Boston Marine Society, the Royal Astronomical Society, the Palermo Academy of Science, and the Royal Academy of Berlin.

Nathaniel Bowditch outlived all of his brothers and sisters by nearly 30 years. He died on March 16, 1838, in his sixty-fifth year. The following eulogy by the Salem Marine Society indicates the regard in which this distinguished American was held by his contemporaries:

“In his death a public, a national, a human benefactor has departed. Not this community, nor our country only, but the whole world, has reason to do honor to his memory. When the voice of Eulogy shall be still, when the tear of Sorrow shall cease to flow, no monument will be needed to keep alive his memory among men; but as long as ships shall sail, the needle point to the north, and the stars go through their wonted courses in the heavens, the name of Dr. Bowditch will be revered as of one who helped his fellow-men in a time of need, who was and is a guide to them over the pathless ocean, and of one who forwarded the great interests of mankind.”

Bowditch is buried in historic Mount Auburn Cemetery in Cambridge, Massachusetts. There is a bronze statue of Nathaniel Bowditch within the cemetery that marks his life.

THE NEW AMERICAN
PRACTICAL NAVIGATOR;
BEING AN
EPITOME OF NAVIGATION;
CONTAINING ALL THE TABLES NECESSARY TO BE USED WITH THE
NAUTICAL ALMANAC,
IN DETERMINING THE
L A T I T U D E;
AND THE
LONGITUDE BY LUNAR OBSERVATIONS;
AND
KEEPING A COMPLETE RECKONING AT SEA:
ILLUSTRATED BY
PROPER RULES AND EXAMPLES:
THE WHOLE EXEMPLIFIED IN A
J O U R N A L,
KEPT FROM
BOSTON TO MADEIRA,
IN WHICH ALL THE RULES OF NAVIGATION ARE INTRODUCED:

A L S O
See Description of the most useful Rules of Trigonometry; With many useful Problems in Mensuration, Surveying,
and Gauging; And a Dictionary of Sea-Terms; with the Manner of performing the most common Evolutions at Sea,
TO WHICH ARE ADDED,
SOME GENERAL OBSERVATIONS and INFORMATION of MERCHANTS, MASTERS of VESSELS, and others concerned in Navigation,
relative to MARITIME LAWS and MANROVING CUSTOMS.

FROM THE BEST AUTHORITIES.

ENRICHED WITH A NUMBER OF
N E W T A B L E S,
WITH ORIGINAL IMPROVEMENTS AND ADDITIONS, AND A LARGE
VARIETY OF NEW AND IMPORTANT MATTER:
A L S O,
MANY THOUSAND ERRORS ARE CORRECTED,
WHICH HAVE APPEARED IN THE BEST SYSTEMS OF NAVIGATION YET PUBLISHED.

BY **NATHANIEL BOWDITCH,**
FELLOW OF THE AMERICAN ACADEMY OF ARTS AND SCIENCES.

ILLUSTRATED WITH COPPERPLATES.

First Edition.

PRINTED AT NEWBURYPORT, (Mass.) 1802,

BY
EDMUND M. BLUNT, (Proprietor)
FOR CUSHING & APPLETON, SALEM.

AND BY FIFTY BOOKSELLERS, STATIONERS, AND MATHEMATICAL INSTRUMENTMAKERS,
IN THE UNITED STATES AND WEST INDIES.

Original title page of *The New American Practical Navigator*, First Edition, published in 1802.

PREFACE

The Naval Observatory library in Washington, D.C., is unnaturally quiet. It is a large circular room, filled with thousands of books. Its acoustics are perfect; a mere whisper from the room's open circular balcony can be easily heard by those standing on the ground floor. A fountain in the center of the ground floor softly breaks the room's silence as its water stream gently splashes into a small pool. From this serene room, a library clerk will lead you into an antechamber, beyond which is a vault containing the Observatory's most rare books. In this vault, one can find an original 1802 first edition of the *New American Practical Navigator*.

One cannot hold this small, delicate, slipcovered book without being impressed by the nearly 200-year unbroken chain of publication that it has enjoyed. It sailed on U.S. merchantmen and Navy ships shortly after the quasi-war with France and during British impressment of merchant seamen that led to the War of 1812. It sailed on U.S. Naval vessels during operations against Mexico in the 1840's, on ships of both the Union and Confederate fleets during the Civil War, and with the U.S. Navy in Cuba in 1898. It went around the world with the Great White Fleet, across the North Atlantic to Europe during both World Wars, to Asia during the Korean and Vietnam Wars, and to the Middle East during Operation Desert Storm. It has circled the globe with countless thousands of merchant ships for 200 years.

As navigational requirements and procedures have changed throughout the years, *Bowditch* has changed with them. Originally devoted almost exclusively to celestial navigation, it now also covers a host of modern topics. It is as practical today as it was when Nathaniel Bowditch, master of the *Putnam*, gathered the crew on deck and taught them the mathematics involved in calculating lunar distances. It is that practicality that has been the publication's greatest strength, and that makes the publication as useful today as it was in the age of sail.

Seafarers have long memories. In no other profession is tradition more closely guarded. Even the oldest and most cynical acknowledge the special bond that connects those who have made their livelihood plying the sea. This bond is not comprised of a single strand; rather, it is a rich and varied tapestry that stretches from the present back to the birth of our nation and its seafaring culture. As this book is a part of that tapestry, it should not be lightly regarded; rather, it should be preserved, as much for its historical importance as for its practical utility.

Since antiquity, mariners have gathered available navigation information and put it into a text for others to follow. One of the first attempts at this involved volumes of

Spanish and Portuguese navigational manuals translated into English between about 1550 and 1750. Writers and translators of the time "borrowed" freely in compiling navigational texts, a practice which continues today with works such as *Sailing Directions* and *Pilots*.

Colonial and early American navigators depended exclusively on English navigation texts because there were no American editions. The first American navigational text, *Orthodoxal Navigation*, was completed by Benjamin Hubbard in 1656. The first American navigation text published in America was Captain Thomas Truxton's *Remarks, Instructions, and Examples Relating to the Latitude and Longitude; also the Variation of the Compass, Etc., Etc.*, published in 1794.

The most popular navigational text of the late 18th century was John Hamilton Moore's *The New Practical Navigator*. Edmund M. Blunt, a Newburyport publisher, decided to issue a revised copy of this work for American navigators. Blunt convinced Nathaniel Bowditch, a locally famous mariner and mathematician, to revise and update *The New Practical Navigator*. Several other learned men assisted in this revision. Blunt's *The New Practical Navigator* was published in 1799. Blunt also published a second American edition of Moore's book in 1800.

By 1802, when Blunt was ready to publish a third edition, Nathaniel Bowditch and others had corrected so many errors in Moore's work that Blunt decided to issue the work as a first edition of the *New American Practical Navigator*. It is to that 1802 work that the current edition of the *American Practical Navigator* traces its pedigree.

The *New American Practical Navigator* stayed in the Bowditch and Blunt family until the government bought the copyright in 1867. Edmund M. Blunt published the book until 1833; upon his retirement, his sons, Edmund and George, took over publication. The elder Blunt died in 1862; his son Edmund followed in 1866. The next year, 1867, George Blunt sold the copyright to the government for \$25,000. The government has published *Bowditch* ever since. George Blunt died in 1878.

Nathaniel Bowditch continued to correct and revise the book until his death in 1838. Upon his death, the editorial responsibility for the *American Practical Navigator* passed to his son, J. Ingersoll Bowditch. Ingersoll Bowditch continued editing the *Navigator* until George Blunt sold the copyright to the government. He outlived all of the principals involved in publishing and editing the *Navigator*, dying in 1889.

The U.S. government has published some 53 editions since acquiring the copyright to the book that has come to

be known simply by its original author's name, "*Bowditch*." Since the government began production, the book has been known by its year of publishing, instead of by the edition number. The extensively revised 2017 edition is a "digital" one with the official version in continuous maintenance and hosted on NGA's maritime safety information web portal. As with NGA's other nautical publication, the digital edition eliminates the need "to print" new editions in order to get new information out to the marine navigation community.

As much as it is a part of history, *Bowditch* is not a history book. In this edition, as in past editions, dated material was dropped and new methods, technologies and techniques added to keep pace with changes in the practice of navigation. The changes are intended to ensure *Bowditch* remains the premier reference work for modern, practical marine navigation. This edition replaces but does not cancel former editions, which may be retained and consulted as to historical navigation methods not discussed herein.

Due to critical feedback from academia, the 2017 edition reconstitutes several deleted or abridged chapters removed from the previous two editions. The additional text warranted the return of a two-volume format, with the useful tables and glossary of marine navigation located in volume II.

PART 1, FUNDAMENTALS, includes an overview of the topic of marine navigation and the organizations which develop, support and regulate it. These fundamentals include chapters relating to geodesy and chart datums; modern hydrography; the types, structure, use and limitations of nautical charts; electronic chart display and information systems; and finally a concise explanation and summary of the various navigational publications necessary for prudent marine navigation.

PART 2, PILOTING, mainly emphasizes the practical aspects of navigating a vessel in restricted waters, using both traditional and electronic methods. The closely related problem of finding the course & distance between one known point and another, and using The Sailings, is also discussed.

PART 3, CELESTIAL NAVIGATION, reflects the renewed interest in the age old art and science of navigation by the stars, planets, moon and sun. The update recognizes the trend to over rely on GPS and electronic navigation by offering the tried and true alternative method in the event of electronic failures.

PART 4, INERTIAL NAVIGATION, is often referred to as a sophisticated dead reckoning method. The topic is re-introduced in the 2017 edition.

PART 5, RF NAVIGATION TECHNIQUES, explains the nature of radio waves and electronic navigation systems. Chapters deal with several electronic methods of navigation--satellite, Loran, and Radar, with special emphasis on satellite navigation systems.

PART 6, ALTERNATIVE NAVIGATION TECHNIQUES, addresses the topic of bathymetric navigation. This comes in direct response to several *Bowditch* survey responses received by NGA. Doppler sonar navigation is also reintroduced.

PART 7, NAVIGATIONAL SAFETY, discusses recent developments in management of navigational resources, the changing role of the navigator, distress and safety communications, procedures for emergency navigation, and the increasingly complex web of navigation regulations.

PART 8, ICE & POLAR NAVIGATION, in the Arctic is of renewed interest to the navigator as ice-free conditions allow shorter sailing distances. That said, a chapter on polar navigation is reintroduced in the 2017 edition.

PART 9, OCEANOGRAPHY, has been updated to reflect the latest science and terminology.

PART 10, MARINE METEOROLOGY, incorporates updated weather information and many new graphics.

NGA seeks and encourages critical feedback on this publication. Suggestions and comments for changes and additions may be sent to:

MARITIME SAFETY OFFICE
MAIL STOP N64-SFH
NGA
7500 GEOINT DRIVE.
SPRINGFIELD, VIRGINIA, 22150-7500
UNITED STATES OF AMERICA
Email: mcdpubs@nga.mil

Summary of sections subject to third party protection include: Chapter 5 - ECDIS (content from IHO & IMO documents, standards and circulars cited), Chapter 23 - Radar Navigation (section 2317 - Parallel Indexing), Chapter 25 - Doppler Sonar Navigation (IEEE Proceeding articles cited), Chapter 26 - Bathymetric Navigation (U.S. Naval Institute publications cited), Chapter 38 - Weather Elements & Chapter 39 - Tropical Cyclones (images from UCAR/COMMET Program). See individual chapter reference sections for more details.

ACKNOWLEDGMENTS

This 2017 edition of *The American Practical Navigator (Bowditch)*, Pub No. 9, which, in this 53rd edition since 1802, exists to codify the latest body of marine navigation knowledge and practical application. Its publication success is a result of the dedicated efforts of many hands and voices from academia, science and seafaring experts. This edition has advanced from the judiciously shaped recommendations—some comprehensive, some minute, all indispensable—of a multitude of maritime and science professionals. At the same time, it was equally essential that those recommendations be compared, vetted, and applied in a consistent manner and with a clear vision, a challenging task performed in exemplary fashion by this edition's principal editor, **Dr. Gerard J. Clifford, Jr.**

Many institutions, organizations, groups and individuals directly contributed or assisted in the success of the publication of this 2017 edition of *Bowditch*. Of particular note, grateful acknowledgment of effort goes out to the following:

California State University Maritime Academy:

Captain Tuuli Messer-Bookman, Samuel R. Pecota, Captain Scott Powell

Carnegie Science/Observatory:

John Grula, Tina McDowell

Civilian mariners:

James Baldwin on board the HORIZON CONSUMER, Allan B. Campbell, John A. Graham on board the USNS ARCTIC, Michael J. Holliday on board the USNS SISLER, Christopher Moore, Jere M. St. Angelo

College of William and Mary:

Dr. Christopher M. Bailey

European Space Agency:

Dr. Avila Rodriguez

Hempstead Maritime Training LLC:

Christian Hempstead

Huntington Library:

Dr. Daniel Lewis

International Hydrographic Bureau/International Hydrographic Organization:

Tony Pharaoh, David Wyatt

International Maritime Organization:

Simone Leyers

Johns Hopkins University-Applied Physics Laboratory:

Mr. Ned A. Brokloff, Ms. Leah C. Campbell, Mr. Jeffrey L. Girsch, Ms. Michelle C. Greiner, Dr. Shannon M. Hall, Dr. Daniel G. Jablonski, Mr. George H. Klaus III, Mr. Bradford J. Lapsinsky, Mr. Andrew E. Love Jr., Dr. William R. Mar-

tin, Dr. David L. Porter, Mr. David R. Stark, Mr. Jonathan J. Thomas, Mr. Gregory L. Weaver

Maine Maritime Academy:

Captain Andy Chase, Captain Les Eadie, Captain Donald P. Eley, Captain Nathan D. Powers, Captain Adam Slazas, Captain Sam Teel

Maritime Institute of Technology and Graduate Studies:

Captain John Brennan, Mr. Glen Paine

Massachusetts Maritime Academy:

John L. Belle, Captain Michael R. Burns Jr., Captain Craig N. Dalton, Laurel Delong, David B. Mackey, Captain Patrick J. Modic, Linda Letourneau

NASA:

James White

Northrop Grumman Sperry Marine:

Michael R. Sawyer

Norwegian Coastal Administration:

Anne Grethe Nilson, John E. Hagen

Pennsylvania State University - Advanced Research Laboratory:

Mr. Lee R. Insley

State University of New York Maritime College:

James Rogin

Teledyne RDI:

Blair Brumley, Paul Wanis

Texas A&M Maritime Academy:

Captain James P. Cleary, Captain Scott Putty, Captain Augusta “Gussie” D. Roth

U. S. Army Transportation Command:

Robert H. Brockman

U. S. Coast Guard:

LCDR Lawrence F. Ahlin, Mr. Jorge Arroyo, BMC Doug Bullock, Thomas R. Casey, BMCS Scott Cichoracki, LT Nick Cichucki (USN), LT Andrew Dennelly, George H. Detweiler, LT Brennan P. Dougherty, Mr. Clay Diamond (USCG Ret.), Mr. Paul Eulitt, LT Trip Fernandes, LT Nick Forni, LT Curt Gookin, LTJG Clay Haywood, CDR Michael Hicks, LT Mike Higbie, LT Eric W. Johnson, LT Taylor Kellogg, Mr. Robert D. Lewald, Mr. Vernon L. Mann, C.B. Mauro, CDR Gabrielle G. McGrath, USCG (Ret.), Mr. David Merrill, Mr. Russ Levin, BMC John C. Lobherr, CDR Stephen A. Love, LT Dan Miller, ENS Nickolette A. Morin, MST2 Daniel M. Morrissey, CAPT Steven W. Nerheim USN (Ret), LT Nathan Neuhardt, LT Andrew Norberg, Mr. Frank L. Parker, LCDR Michael A. Patterson, LT Patrick R. Powers, LT Eric Quigley, LT Jackie D. Ramirez, ET2 Chelsea Rasmussen, Mr. Bruce R. Riley, LT Sarah K. Shveda, CAPT Scott J. Smith, CDR John M.

Stone, BMCM Tim Sullivan, E.J. Terminella, Mr. Robert M. Trainor, Mr. Steve Tucker, BOSN Tim Tully, CDR Michael A. Turdo, LCDR Matthew J. Walter, CDR William C. Woityra

U. S. Maritime Administration:

Kevin Kolhman, Kevin M. Tokerski

U. S. National Oceanic and Atmospheric Administration:

Dr. Benjamin Albright, Eric Blake, Johan Booth, Tyro Brown, Hugh Cobb, RADM Samuel De Bow, NOAA (Ret.), Patrick A. Dixon, James Franklin, Megan Greenaway, Mark Griffin, Colby A. Harmon, Robert Heeley, Craig Hodan, Paul Lee, Rick Lumpkin, John Brent Macek, CDR Gabrielle G McGrath (USCG), Martin Nelson, Richard Pasch, LT Joseph T. Phillips, Julia Powell, Dr. Scott D. Rudlosky, Paula Rychtar, Joseph Sienkiewics, Stacy Stewart, Dr. Rodney Viereck, LTJG Jason P. Wilson, Gregory Zwicker

U.S. National Geospatial-Intelligence Agency:

Mr. John A. Gandy, Ms. Dorthea Horne, LT Richard C. Johnson (USNR), Dr. J.N. (Nikki) Markiel, Mr. Dennis J. McCleary, Dr. Terry Monroe, Mr. Daniel F. Mullaney, Ms. Elizabeth Neise, CAPT Philip J. Saltzman (USNR), Ms. Carling R. Uhler, Mr. Muridith W. Winder

U. S. Naval Academy:

LCDR Andrew Storey, Royal Navy

U. S. Naval Institute:

Thomas J. Cutler

U. S. Naval Oceanographic Office:

Scott Davison, Susan Sebastian

U. S. Naval Observatory:

Jennifer Bartlett, James L. Hilton, George H. Kaplan, Demetrios Mataskis, Dr. Nancy A. Oliverson, OMC Tim Sheedy (USN), Susan G. Stewart, Mark S. Stollberg, Sean E. Urban

U. S. Navy COMPACFLT:

Daniel G. Morris, LCDR Mark H. Schaff

U. S. Navy Military Sealift Command:

Patrick T. Christian

U. S. Navy Space and Naval Warfare Systems

Command:

Robert A. Greer

U. S. Navy Surface Warfare Officer School:

QMC Robert P. Hoops, LT Andrew P. McCarthy, LT Kevin F. Mullins, LCDR Douglas E Raineault, QMCS David A. Rodriguez, Captain Bud Weeks

University Corporation for Atmospheric Research:

Christopher J. Kennedy

University of New Hampshire:

Dr. Lee Alexander, Colleen Mitchell, Tara Hicks Johnson

UrsaNav:

Chuck Schue

WR Systems Ltd:

CAPT Paul K. Heim, USN (Ret.)

Acknowledgment must also be extended to the following dedicated maritime navigation experts who examined the penultimate draft of this manuscript and meticulously analyzed, commented, proofread, edited and prepared it for publication:

Mr. Keith E. Alexander
Mr. David E. Allen
Mr. David W. Anderson
Ms. Jacqueline Barone
CAPT Anthony G. Bastidas
LCDR Daniel E. Butler, USN
QMCM Randy L. Bryant USN (Ret.)
Mr. Sebastian P. Carisio
Mr. Howard J. Cohen
Mr. Matthew M Cronin
Mr. Brian M. Drew
Mr. Peter M. Doherty
Mr. Keith E. Dominic
Mr. Patrick V. Dorr
QMC Philip Dorsainvil, USN (Ret.)
Mr. James D. Ford
Ms. Billie Jean Gooch
CAPT LeeAnne E. Gordon
Mr. Joseph A. Grzymkowski III
Ms. Misty R. Harris
Ms. Donna M. Harrison
Mr. John J. Haumann Jr.
Mr. Brian R. Heap
Mr. Walter D. Holtgren
Mr. Matthew C. Hume
Mr. Jerome Hyman
Mrs. Jennifer Kearns
Mr. Carl G. Kaempfer
Mr. Virgil (Buddy) R. Klepper, Jr.
Mr. Michael S. Kushla
Ms. Prasnee K. Luebke
Ms. Ann M. Luken
Mr. Christopher J. Lonergan
Mr. Michael W. Maucri
Ms. Sheryl L. McCash
Mr. Sean M. McGurgan
Mr. Philip Meeks
Mr. Ryan S. Milligan
Ms. Sara R. Mock
Mr. Eugene L. Moisan
ETC Robert J. Mueller, Jr., USN (Ret.)
Mr. Darryl R. Mulato
Mr. Mark E. Nueslein
Mr. Steven R. Offenback
Mr. Jason J. Otero-Torres
CAPT Geoffrey J. Phelps
Mr. Robert J. Raffles
Mr. James E. Rogers, Jr.
LCDR Douglas L. Roush, USN (Ret.)
Mr. Frederick R. Sanders

LCDR Jared B. Shorter, USNR
Mr. Christopher W. Sisson
Ms. DanaAnn T. Sisson
Mr. Jason D. Strom
Mr. Jamison N. Stubbs
Mr. Andrew M. Sullivan
Mr. Michael A. Theberge
Mr. Stuart Vick
Mr. John W. von Rosenberg
Mr. Brian S. Walker
QMC James F. Witts II, USN (Ret.)

Mr. Jeffrey M. Whittaker
QMC Shane T. Wilson, USN (Ret.)
Ms. Rachael C. Wold
Mr. Paul C. Youngs

QMCM Michael G. Harrison, U.S. Navy (Ret.)
Chief, Publications Branch
Maritime Safety Office
National Geospatial-Intelligence Agency
Springfield, Virginia

CHAPTER 1

INTRODUCTION TO MARINE NAVIGATION

DEFINITIONS

100. The Art and Science of Navigation

Marine navigation is a blend of both science and art. A key union between the knowledge of theory, the application of mathematics and the exercise of seafaring instincts that have proven to be the crucial elements behind successful maritime voyages for millennia.

A good navigator is one who plans each voyage carefully. As the vessel proceeds, he or she gathers navigation information from a variety of sources and then evaluates this information to determine the ship's position. The navigator then compares that position against the voyage plan, operational commitments, and their pre-determined "dead reckoning" position. A good navigator also anticipates dangerous situations well before they arise, and always stays "ahead of the vessel," ready to address navigational emergencies at any time. The navigator is increasingly a manager of a diverse assortment of resources—electronic, mechanical, and human. Navigation methods and techniques vary with the type of vessel, the conditions, and the navigator's experience. The navigator uses the methods and techniques best suited to the vessel, its equipment, and conditions at hand.

Some important elements of successful navigation cannot be acquired from any book or instructor. The science of navigation can be taught, but the art of navigation must be developed from experience.

101. Types of Navigation

Methods of navigation have changed throughout history. New methods often enhance the mariner's ability to complete their voyage safely and expeditiously, and make the job easier. One of the most important judgments the navigator must make involves choosing the best methods to use. Each method or type has advantages and disadvantages, while none is effective in all situations. Some commonly recognized types of navigation include:

- **Bathymetric navigation** uses the topography of the sea floor to acquire positioning data. A vessel's position is determined with respects to known locations of geographic features of the ocean bottom.
- **Celestial navigation** involves reducing celestial measurements taken with a sextant to lines of

position using calculators or computer programs, or by hand with almanacs and tables or using spherical trigonometry.

- **Dead reckoning (DR)** determines a predicted position by advancing a known position for courses and distances. A position so determined is called a dead reckoning (DR) position. It is generally accepted that only course and speed determine the DR position. Correcting the DR position for leeway, current effects, and steering error result in an **estimated position (EP)**.
- **Inertial navigation** is accomplished by integrating the output of a set of sensors to compute position, velocity and attitude. These sensors include gyros and accelerometers. Gyros measure angular rate with respect to inertial space and accelerometers measure linear acceleration with respect to an inertial frame.
- **Piloting** involves navigating in restricted waters with frequent or constant determination of position relative to nearby geographic and hydrographic features.
- **Radio navigation** uses radio waves to determine position through a variety of electronic devices.
- **Radar navigation** uses radar to determine the distance from or bearing to objects whose position is known. This process is separate from radar's use in collision avoidance.
- **Satellite navigation** uses radio signals from satellites for determining position.

Electronic systems and integrated bridge concepts are driving navigation system planning. Integrated systems take inputs from various ship sensors, electronically and automatically chart the position, and provide control signals required to maintain a vessel on a preset course. The navigator becomes a system manager, choosing system presets, interpreting system output, and monitoring vessel response.

In practice, a navigator synthesizes different methodologies into a single integrated system. He or she should never feel comfortable utilizing only one method when others are also available. Since each method has advantages

and disadvantages, the navigator must choose methods appropriate to each situation, and never rely completely on only one system.

With the advent of automated position fixing and electronic charts, modern navigation has become an almost completely electronic process. The mariner is constantly tempted to rely solely on electronic systems. But electronic navigation systems are always subject to potential failure, and the professional mariner must never forget that the safety of their ship and crew may depend on skills that differ little from those practiced generations ago. Proficiency in conventional piloting and celestial navigation remains essential.

102. Phases of Navigation

Four distinct phases define the navigation process. The mariner should choose the system mix that best meets the accuracy requirements of each phase.

- **Inland Waterway Phase:** Piloting in narrow canals, channels, rivers, and estuaries.
- **Harbor/Harbor Approach Phase:** Navigating to a harbor entrance through bays and sounds, and

negotiating harbor approach channels.

- **Coastal Phase:** Navigating within 50 miles of the coast or inshore of the 200 meter depth contour.
- **Ocean Phase:** Navigating outside the coastal area in the open sea.

The navigator's position accuracy requirements, fix intervals, and systems requirements differ in each phase. The following table can be used as a general guide for selecting the proper system(s).

	<i>Inland</i>	<i>Harbor/ Approach</i>	<i>Coastal</i>	<i>Ocean</i>
Bathy			X	X
Celestial			X	X
DR	X	X	X	X
Inertial			X	X
Piloting	X	X	X	
Radio		X	X	X
Radar	X	X	X	
Satellite	X*	X	X	X

*Table 102. The relationship of the types and phases of navigation. * With SA off and/or using DGPS.*

NAVIGATION TERMS AND CONVENTIONS

103. Important Conventions and Concepts

Throughout the history of navigation, numerous terms, techniques, and conventions have been established which enjoy worldwide recognition. The professional navigator, to gain a full understanding of this field, should understand the origin of certain terms, techniques, and conventions. The following section discusses some of these important factors.

Defining a **prime meridian** is a comparatively recent development. Until the beginning of the 19th century, there was little uniformity among cartographers as to the meridian from which to measure longitude. But it mattered little because there existed no method for determining longitude accurately.

Ptolemy, in the 2nd century AD, measured longitude eastward from a reference meridian 2 degrees west of the Canary Islands. In 1493, Pope Alexander VI established a line in the Atlantic west of the Azores to divide the territories of Spain and Portugal. For many years, cartographers of these two countries used this dividing line as the prime meridian. In 1570 the Dutch cartographer Ortelius used the easternmost of the Cape Verde Islands. John Davis, in his 1594 *The Seaman's Secrets*, used the Isle of Fez in the Canaries because there the magnetic variation was zero. Most mariners paid little attention to these conventions and often reckoned their longitude from several different capes and ports during a voyage.

The meridian of London was used as early as 1676, and

over the years its popularity grew as England's maritime interests increased. The system of measuring longitude both east and west through 180° may have first appeared in the middle of the 18th century. Toward the end of that century, as the Greenwich Observatory increased in prominence, English cartographers began using the meridian of that observatory as a reference. The publication by the Observatory of the first British *Nautical Almanac* in 1767 further entrenched Greenwich as the prime meridian. An unsuccessful attempt was made in 1810 to establish Washington, D.C. as the prime meridian for American navigators and cartographers. In 1884, the meridian of Greenwich was officially established as the prime meridian. Today, all maritime nations have designated the Greenwich meridian the prime meridian, except in a few cases where local references are used for certain harbor charts.

Charts are graphic representations of areas of the Earth, in digital or hard copy form, for use in marine or air navigation. Nautical charts, whether in digital or paper form, depict features of particular interest to the marine navigator. Charts probably existed as early as 600 B.C. Stereographic and orthographic projections date from the 2nd century B.C. In 1569 Gerardus Mercator published a chart using the mathematical principle which now bears his name. Some 30 years later, Edward Wright published corrected mathematical tables for this projection, enabling other cartographers to produce charts on the Mercator projection. This projection is still the most widely used.

Sailing Directions or **pilots** have existed since at least

the 6th century B.C. Continuous accumulation of navigational data, along with increased exploration and trade, led to increased production of volumes through the Middle Ages. “Routiers” were produced in France about 1500; the English referred to them as “rutters.” In 1584 Lucas Waghenauer published the *Spiegel der Zeevaerdt* (*The Mariner’s Mirror*), which became the model for such publications for several generations of navigators. They were known as “Waggoners” by most sailors.

The **compass** was developed more than 1000 years ago. The origin of the magnetic compass is uncertain, but Norsemen used it in the 11th century, and Chinese navigators used the magnetic compass at least that early and probably much earlier. It was not until the 1870s that Lord Kelvin developed a reliable dry card marine compass. The fluid-filled compass became standard in 1906.

Variation was not understood until the 18th century, when Edmond Halley led an expedition to map lines of variation in the South Atlantic. **Deviation** was understood at least as early as the early 1600s, but adequate correction of compass error was not possible until Matthew Flinders discovered that a vertical iron bar could reduce certain types of errors. After 1840, British Astronomer Royal Sir George Airy and later Lord Kelvin developed combinations of iron masses and small magnets to eliminate most magnetic compass error.

The **gyrocompass** was made necessary by iron and steel ships. Leon Foucault developed the basic gyroscope in 1852. An American (Elmer Sperry) and a German (Anshutz Kampfe) both developed electrical gyrocompasses in the early years of the 20th century. Ring laser gyrocompasses and digital flux gate compasses are gradually replacing traditional gyrocompasses, while the magnetic compass remains an important backup device.

The **log** is the mariner’s speedometer. Mariners originally measured speed by observing a chip of wood passing down the side of the vessel. Later developments included a wooden board attached to a reel of line. Mariners measured speed by noting how many knots in the line unreel as the ship moved a measured amount of time; hence the term **knot**. Mechanical logs using either a small paddle wheel or a rotating spinner arrived about the middle of the 17th century. The taffrail log still in limited use today was developed in 1878. Modern logs use electronic sensors or spinning devices that induce small electric fields proportional to a vessel’s speed. An engine revolution counter or shaft log often measures speed aboard large ships. Doppler speed logs are used on some vessels for very accurate speed readings. Inertial and satellite systems also provide highly accurate speed readings.

The common measure of distance at sea is the **nautical mile** which is now defined as exactly 1,852 meters. Nautical charts may show depths in meters, fathoms, or feet. The **fathom** as a unit of length or depth is of obscure origin. Posidonius reported a sounding of more than 1,000 fathoms in the 2nd century B.C. How old the unit was then

is unknown. A fathom is a unit of length equal to 6 feet.

Most National Oceanographic and Atmospheric Administration (NOAA) charts have depths recorded in feet or fathoms. About two dozen of NOAA’s 1,000 plus charts show depths in meters. The National Geospatial-Intelligence Agency (NGA) continues to produce and convert chart depths entirely to meters.

The sailings refer to various methods of mathematical determining course, distance, and position. They have a history almost as old as mathematics itself. Thales, Hipparchus, Napier, Wright, and others contributed the formulas that permit computation of course and distance by plane, traverse, parallel, middle latitude, Mercator, and great circle sailings.

104. The Earth

The Earth is an irregular oblate spheroid (a sphere flattened at the poles). Measurements of its dimensions and the amount of its flattening are subjects of geodesy. However, for most navigational purposes, assuming a spherical Earth introduces insignificant error. The Earth’s axis of rotation is the line connecting the north and south geographic poles.

A **great circle** is the line of intersection of a sphere and

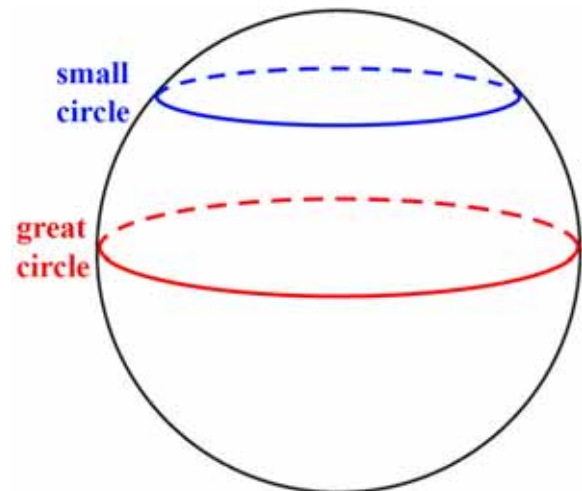

Figure 104a. Great and small circles.

a plane through its center. This is the largest circle that can be drawn on a sphere. The shortest line on the surface of a sphere between two points on the surface is part of a great circle. On the spheroidal Earth the shortest line is called a geodesic. A great circle is a near enough approximation to a geodesic for most problems of navigation. A **small circle** is the line of intersection of a sphere and a plane which does not pass through the center. See Figure 104a.

The term **meridian** is usually applied to the **upper branch** of the half-circle from pole to pole which passes through a given point. The opposite half is called the **lower branch**.

A **parallel** or parallel of latitude is a circle on the

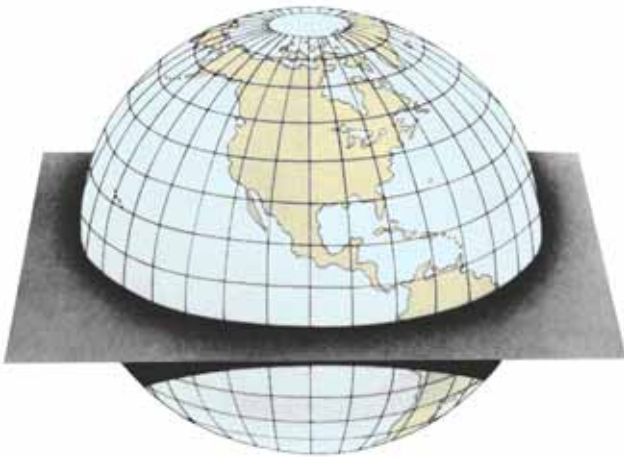

Figure 104b. The equator is a great circle midway between the poles.

surface of the Earth parallel to the plane of the equator. It connects all points of equal latitude. The **equator** is a great circle at latitude 0° that bisects the Northern and Southern Hemispheres. See Figure 104b. The poles are single points at latitude 90° . All other parallels are small circles.

105. Coordinates

Coordinates of latitude and longitude can define any position on Earth. **Latitude (L, lat.)** is the angular distance from the equator, measured northward or southward along a meridian from 0° at the equator to 90° at the poles. It is designated north (N) or south (S) to indicate the direction of measurement.

The **difference of latitude (l, DLat.)** between two places is the angular length of arc of any meridian between their parallels. It is the numerical difference of the latitudes if the places are on the same side of the equator; it is the sum of the latitudes if the places are on opposite sides of the equator. It may be designated north (N) or south (S) when appropriate. The middle or **mid-latitude (Lm)** between two places on the same side of the equator is half the sum of their latitudes. Mid-latitude is labeled N or S to indicate whether it is north or south of the equator.

The expression may refer to the mid-latitude of two places on opposite sides of the equator. In this case, it is equal to half the difference between the two latitudes and takes the name of the place farthest from the equator.

Longitude (l, long.) is the angular distance between the prime meridian and the meridian of a point on the Earth, measured eastward or westward from the prime meridian through 180° . It is designated east (E) or west (W) to indicate the direction of measurement.

The **difference of longitude (DLo)** between two places is the shorter arc of the parallel or the smaller angle

at the pole between the meridians of the two places. If both places are on the same side (east or west) of Greenwich, DLo is the numerical difference of the longitudes of the two places; if on opposite sides, DLo is the numerical sum unless this exceeds 180° , when it is 360° minus the sum.

The distance between two meridians at any parallel of latitude, expressed in distance units, usually nautical miles, is called **departure (p, Dep.)**. It represents distance made good east or west as a craft proceeds from one point to another. Its numerical value between any two meridians decreases with increased latitude, while DLo is numerically the same at any latitude. Either DLo or p may be designated east (E) or west (W) when appropriate.

106. Distance on the Earth

Distance, as used by the navigator, is the length of the **rhumb line** connecting two places. This is a line making the same angle with all meridians. Meridians and parallels which also maintain constant true directions may be considered special cases of the rhumb line. Any other rhumb line spirals toward the pole, forming a **loxodromic curve** or **loxodrome**. See Figure 106a below for image depicting

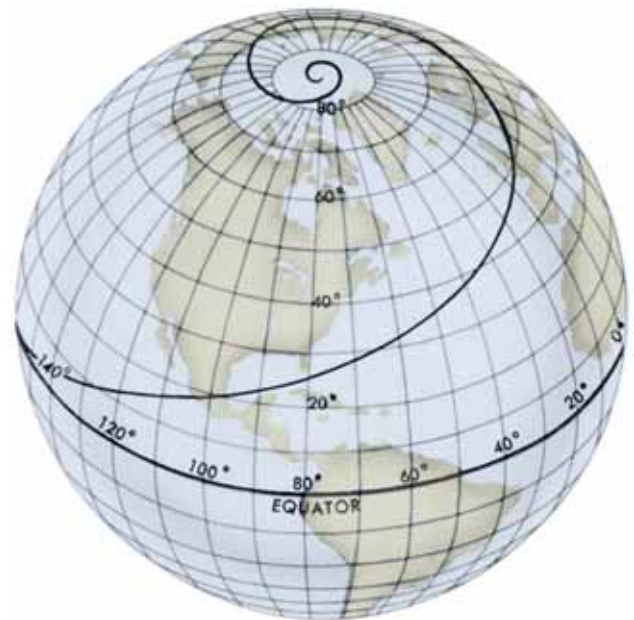

Figure 106a. A loxodrome.

a loxodrome curve.

Distance along the great circle connecting two points is customarily designated **great-circle distance**. For most purposes, considering the nautical mile the length of one minute of latitude introduces no significant error.

Speed (S) is rate of motion, or distance per unit of time. A **knot (kn.)**, the unit of speed commonly used in navigation, is a rate of 1 nautical mile per hour. The expression **speed of advance (SOA)** is used to indicate the speed to be made along the intended track. **Speed over the ground**

(SOG) is the actual speed of the vessel over the surface of the Earth at any given time. To calculate **speed made good (SMG)** between two positions, divide the distance between the two positions by the time elapsed between the two positions.



Figure 106b. For more information concerning loxodromes and projections go to: <http://www.progonos.com/furuti/MapProj/Normal/CartProp/Rhumb/rhumb.html>

107. Direction on the Earth

Direction is the position of one point relative to another. Navigators express direction as the angular difference in degrees from a reference direction, usually north or the ship's head. **Course (C, Cn)** is the horizontal direction in which a vessel is intended to be steered, expressed as angular distance from north clockwise through 360°. Strictly used, the term applies to direction through the water, not the direction intended to be made good over the ground. The course is often designated as true, magnetic, compass, or grid according to the reference direction.

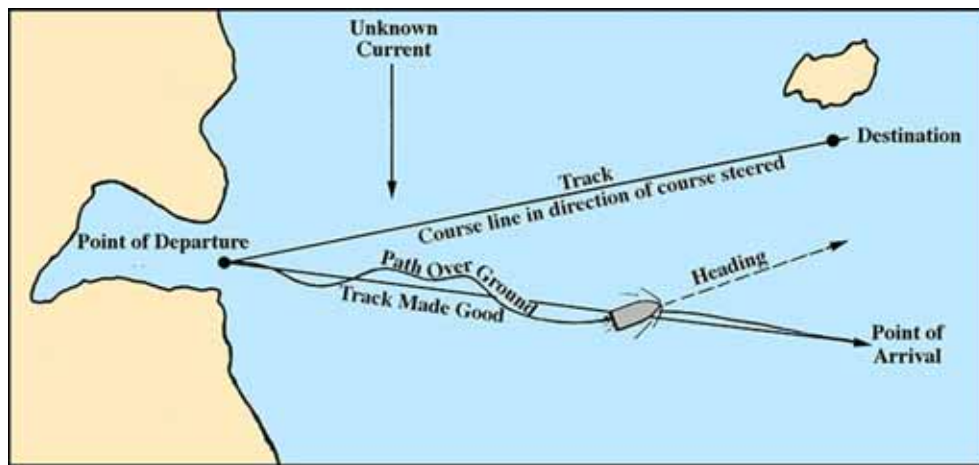

Figure 107a. Course line, track, track made good, and heading.

Track made good (TMG) is the single resultant direction from the point of departure to point of arrival at any given time. The use of this term is preferred to the use of the misnomer “course made good.” **Course of advance (COA)** is the direction intended to be made good over the ground, and **course over ground (COG)** is the direction between a vessel's last fix and an EP. A **course line** is a line drawn on a chart extending in the direction of a course. It is sometimes convenient to express a course as an angle from either north or south, through 90° or 180°. In this case it is designated course angle (C) and should be properly labeled to indicate the origin (prefix) and direction of measurement (suffix). Thus, C N35°E = Cn 035° (000° + 35°), C N155°W = Cn 205° (360° - 155°), C S47°E = Cn 133° (180° - 47°). But Cn 260° may be either C N100°W or C S80°W, depending upon the conditions of the problem.

Track (TR) is the intended horizontal direction of travel with respect to the Earth. The terms intended track and trackline are used to indicate the path of intended travel. See Figure 107a. The track consists of one or a series of course lines, from the point of departure to the destination, along

which one intends to proceed. A great circle which a vessel intends to follow is called a **great-circle track**, though it consists of a series of straight lines approximating a great circle

Heading (Hdg., SH) is the direction in which a vessel is pointed at any given moment, expressed as angular distance from 000° clockwise through 360°. It is easy to confuse heading and course. Heading constantly changes as a vessel yaws back and forth across the course due to sea, wind, and steering error.

Bearing (B, Brg.) is the direction of one terrestrial point from another, expressed as angular distance from 000° (North) clockwise through 360°. When measured through 90° or 180° from either north or south, it is called bearing angle (B). Bearing and azimuth are sometimes used interchangeably, but the latter more accurately refers to the horizontal direction of a point on the celestial sphere from a point on the Earth. A relative bearing is measured relative to the ship's heading from 000° (dead ahead) clockwise through 360°. However, it is sometimes conveniently measured right or left from 000° at the ship's head through 180°. This is particularly true when using the table for Dis-

tance of an Object by Two Bearings.

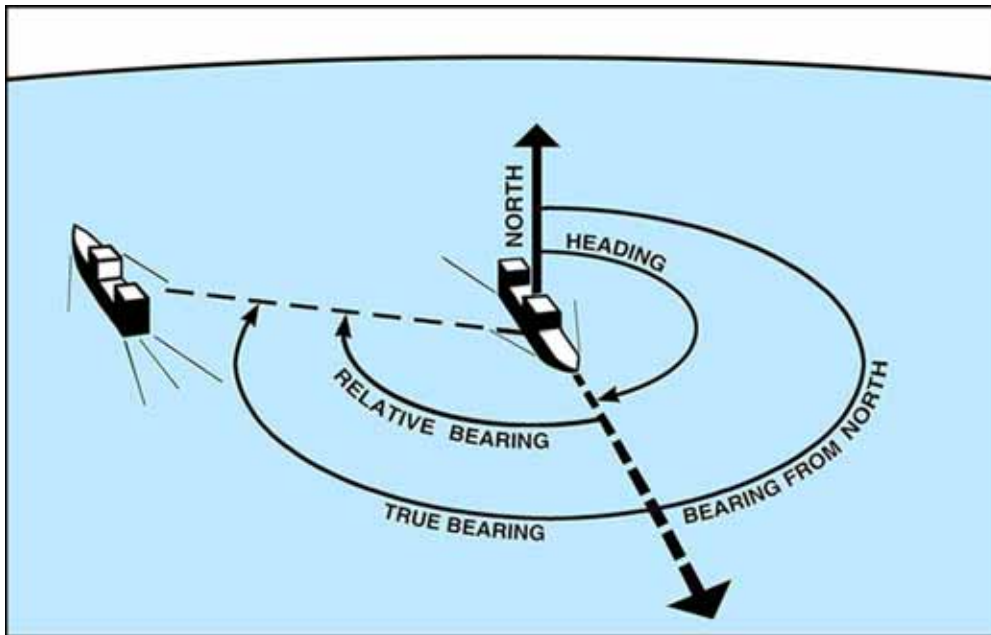

Figure 107b. Relative Bearing

To convert a relative bearing to a true bearing, add the true heading. See Figure 107b.

True Bearing = Relative Bearing + True Heading.
Relative Bearing = True Bearing - True Heading.

108. Finding Latitude and Longitude

Navigators have made latitude observations for thousands of years. Accurate declination tables for the Sun have been published for centuries, enabling ancient seamen to compute latitude to within 1 or 2 degrees. Those who today determine their latitude by measuring the Sun at their meridian and the altitude of Polaris are using methods well known to 15th century navigators.

A method of finding longitude eluded mariners for centuries. Several solutions independent of time proved too cumbersome. Finding longitude by magnetic variation was tried, but found too inaccurate. The lunar distance method, which determines GMT by observing the Moon's position among the stars, became popular in the 1800s. However, the mathematics required by most of these processes were far above the abilities of the average seaman. It was apparent that the solution lay in keeping accurate time at sea.

In 1714, the British Board of Longitude was formed, offering a small fortune in reward to anyone who could provide a solution to the problem.

An Englishman, John Harrison, responded to the challenge, developing four chronometers between 1735 and 1760. The most accurate of these timepieces lost only 15

seconds on a 156 day round trip between London and Barbados. The Board, however, paid him only half the promised reward. The King finally intervened on Harrison's behalf, and at the age of 80 years Harrison received his full reward of £20,000.

Rapid chronometer development led to the problem of determining **chronometer error** aboard ship. **Time balls**, large black spheres mounted in port in prominent locations, were dropped at the stroke of noon, enabling any ship in harbor which could see the ball to determine chronometer error. By the end of the U.S. Civil War, telegraph signals were being used to key time balls. Use of radio signals to send time ticks to ships well offshore began in 1904, and soon worldwide signals were available.

109. The Navigational Triangle

Modern celestial navigators reduce their celestial observations by solving a **navigational triangle** whose points are the elevated pole, the celestial body, and the zenith of the observer. The sides of this triangle are the polar distance of the body (**codeclination**), its zenith distance (**coaltitude**), and the polar distance of the zenith (**colatitude** of the observer).

A spherical triangle was first used at sea in solving **lunar distance** problems. Simultaneous observations were made of the altitudes of the Moon and the Sun or a star near the ecliptic and the angular distance between the Moon and the other body. The zenith of the observer and the two celestial bodies formed the vertices of a triangle whose sides were the two coaltitudes and the angular distance

between the bodies. Using a mathematical calculation the navigator “cleared” this distance of the effects of refraction and parallax applicable to each altitude. This corrected value was then used as an argument for entering the almanac. The almanac gave the true lunar distance from the Sun and several stars at 3 hour intervals. Previously, the navigator had set his or her watch or checked its error and rate with the local mean time determined by celestial observations. The local mean time of the watch, properly corrected, applied to the Greenwich mean time obtained from the lunar distance observation, gave the longitude.

The calculations involved were tedious. Few mariners could solve the triangle until Nathaniel Bowditch published his simplified method in 1802 in *The New American Practical Navigator*.

Reliable chronometers were available by 1800, but their high cost precluded their general use aboard most ships. However, most navigators could determine their longitude using Bowditch’s method. This eliminated the need for parallel sailing and the lost time associated with it. Tables for the lunar distance solution were carried in the American nautical almanac into the 20th century.

110. The Time Sight

The theory of the **time sight** had been known to mathematicians since the development of spherical trigonometry, but not until the chronometer was developed could it be used by mariners.

The time sight used the modern navigational triangle. The codeclination, or polar distance, of the body could be determined from the almanac. The zenith distance (coaltitude) was determined by observation. If the colatitude were known, three sides of the triangle were available. From these the meridian angle was computed. The comparison of this with the Greenwich hour angle from the almanac yielded the longitude.

The time sight was mathematically sound, but the navigator was not always aware that the longitude determined was only as accurate as the latitude, and together they merely formed a point on what is known today as a **line of position**. If the observed body was on the prime vertical, the line of position ran north and south and a small error in latitude generally had little effect on the longitude. But when the body was close to the meridian, a small error in latitude produced a large error in longitude.

The line of position by celestial observation was unknown until discovered in 1837 by 30-year-old Captain Thomas H. Sumner, a Harvard graduate and son of a United States congressman from Massachusetts. The discovery of the “**Sumner line**,” as it is sometimes called, was considered by Maury “the commencement of a new era in practical navigation.” This was the turning point in the development

of modern celestial navigation technique. In Sumner’s own words, the discovery took place in this manner:

Having sailed from Charleston, S. C., 25th November, 1837, bound to Greenock, a series of heavy gales from the Westward promised a quick passage; after passing the Azores, the wind prevailed from the Southward, with thick weather; after passing Longitude 21° W, no observation was had until near the land; but soundings were had not far, as was supposed, from the edge of the Bank. The weather was now more boisterous, and very thick; and the wind still Southerly; arriving about midnight, 17th December, within 40 miles, by dead reckoning, of Tusker light; the wind hauled SE, true, making the Irish coast a lee shore; the ship was then kept close to the wind, and several tacks made to preserve her position as nearly as possible until daylight; when nothing being in sight, she was kept on ENE under short sail, with heavy gales; at about 10 AM an altitude of the Sun was observed, and the Chronometer time noted; but, having run so far without any observation, it was plain the Latitude by dead reckoning was liable to error, and could not be entirely relied on. Using, however, this Latitude, in finding the Longitude by Chronometer, it was found to put the ship 15' of Longitude E from her position by dead reckoning; which in Latitude 52° N is 9 nautical miles; this seemed to agree tolerably well with the dead reckoning; but feeling doubtful of the Latitude, the observation was tried with a Latitude 10' further N, finding this placed the ship ENE 27 nautical miles, of the former position, it was tried again with a Latitude 20' N of the dead reckoning; this also placed the ship still further ENE, and still 27 nautical miles further; these three positions were then seen to lie in the direction of Small’s light. It then at once appeared that the observed altitude must have happened at all the three points, and at Small’s light, and at the ship, at the same instant of time; and it followed, that Small’s light must bear ENE, if the Chronometer was right. Having been convinced of this truth, the ship was kept on her course, ENE, the wind being still SE., and in less than an hour, Small’s light was made bearing ENE 1/2 E, and close aboard.

In 1843 Sumner published a book, *A New and Accurate Method of Finding a Ship’s Position at Sea by Projection on Mercator’s Chart*. He proposed solving a single time sight twice, using latitudes somewhat greater and somewhat less than that arrived at by dead reckoning, and joining the two positions obtained to form the line of position.

The Sumner method required the solution of two time sights to obtain each line of position. Many older navigators preferred not to draw the lines on their charts, but to fix their position mathematically by a method which Sumner had also devised and included in his book. This was a tedious

but popular procedure.

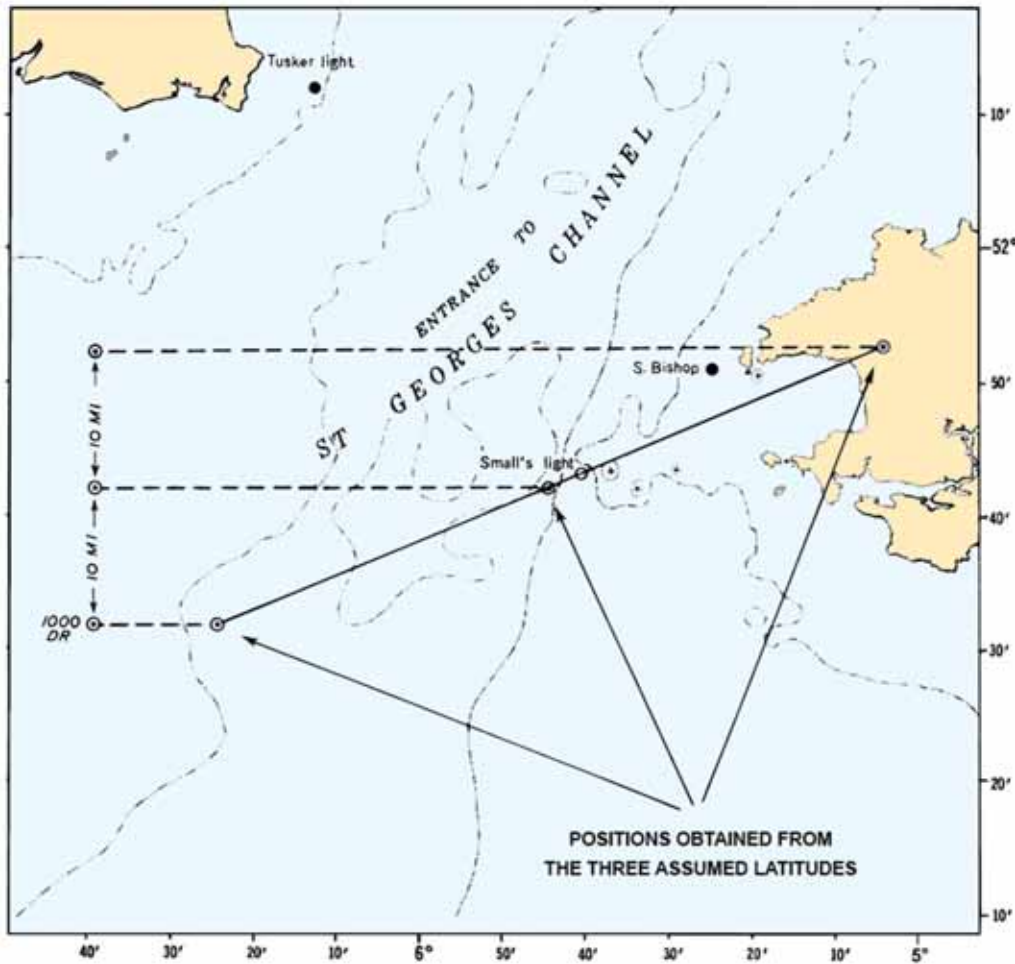

Figure 110. The first celestial line of position, obtained by Captain Thomas Sumner in 1837.

111. Navigational Tables

Spherical trigonometry is the basis for solving every navigational triangle, and until about 80 years ago the navigator had no choice but to solve each triangle by tedious, manual computations.

Lord Kelvin, generally considered the father of modern navigational methods, expressed interest in a book of tables with which a navigator could avoid tedious trigonometric solutions. However, solving the many thousands of triangles involved would have made the project too costly. Computers finally provided a practical means of preparing tables. In 1936 the first volume of *Pub. No. 214* was made available; later, *Pub. No. 229, Sight Reduction Tables for Marine Navigation*, has replaced *Pub. No. 214*. *Pub. No. 249* was provided for air navigators (*Pub. No. 249 Volume I* is now published as *UK Rapid Sight Reduction Table for Navigation NP 303/AP 3270*).

Today, electronic navigation calculators have mostly replaced navigation tables. Scientific calculators with trigonometric functions can easily solve the navigational triangle. Navigational calculators readily solve celestial

sights and perform a variety of voyage planning functions. Using a calculator generally gives more accurate lines of position because it eliminates the rounding errors inherent in tabular inspection and interpolation.

112. Development of Electronic Navigation

Perhaps the first application of electronics to navigation occurred in 1865, when were first used to check chronometer error. This was followed by the transmission of radio time signals for chronometer checks dates to 1904. Radio broadcasts providing navigational warnings, begun in 1907 by the U.S. Navy Hydrographic Office, helped increase the safety of navigation at sea.

By the latter part of World War I the directional properties of a loop antenna were successfully used in the radio direction finder. The first radiobeacon was installed in 1921. Early 20th century experiments by Behm and Langevin led to the U.S. Navy's development of the first practical echo sounder in 1922. Radar and hyperbolic systems grew out of WWII.

Today, electronics touches almost every aspect of navigation. Hyperbolic systems, satellite systems, and electronic charts all require an increasingly sophisticated electronics suite and the expertise to manage them. These systems' accuracy and ease of use make them invaluable assets to the navigator, but there is far more to using them than knowing which buttons to push.

113. Development of Radar

As early as 1904, German engineers were experimenting with reflected radio waves. In 1922 two American scientists, Dr. A. Hoyt Taylor and Leo C. Young, testing a communication system at the Naval Aircraft Radio Laboratory, noted fluctuations in the signals when ships passed between stations on opposite sides of the Potomac River. In 1935 the British began work on radar. In 1937 the USS Leary tested the first sea-going radar, and in 1940 United States and British scientists combined their efforts. When the British revealed the principle of the multicavity magnetron developed by J. T. Randall and H. A. H. Boot at the University of Birmingham in 1939, microwave radar became practical. In 1945, at the close of World War II, radar became available for commercial use.

114. Development of Hyperbolic Radio Aids

Various hyperbolic systems were developed beginning in World War II. These were outgrowths of the British GEE

system, developed to help bombers navigate to and from their missions over Europe. Loran A was developed as a long-range marine navigation system. This was replaced by the more accurate Loran C system, deployed throughout much of the world. Various short range and regional hyperbolic systems have been developed by private industry for hydrographic surveying, offshore facilities positioning, and general navigation.

115. Other Electronic Systems

The underlying concept that led to development of satellite navigation dates to 1957 and the first launch of an artificial satellite into orbit. The first system, NAVSAT, has been replaced by the far more accurate and widely available **Global Positioning System (GPS)**, which has revolutionized all aspects of navigation

The first **inertial navigation system** was developed in 1942 for use in the V2 missile by the Peenemunde group under the leadership of Dr. Wernher von Braun. This system used two 2-degree-of-freedom gyroscopes and an integrating accelerometer to determine the missile velocity. By the end of World War II, the Peenemunde group had developed a stable platform with three single-degree-of-freedom gyroscopes and an integrating accelerometer. In 1958 an inertial navigation system was used to navigate the USS *Nautilus* under the ice to the North Pole.

NAVIGATION ORGANIZATIONS

116. Governmental Role

Navigation only a generation ago was an independent process, carried out by the mariner without outside assistance. With compass and charts, sextant and chronometer, he or she can independently travel anywhere in the world. The increasing use of electronic navigation systems has made the navigator dependent on many factors outside their control. Government organizations fund, operate, and regulate satellites and other electronic systems. Governments are increasingly involved in regulation of vessel movements through traffic control systems and regulated areas. Understanding the governmental role in supporting and regulating navigation is vitally important to the mariner. In the United States, there are a number of official organizations which support the interests of navigators. Some have a policy-making role; others build and operate navigation systems. Many maritime nations have similar organizations performing similar functions. International organizations also play a significant role.

117. The Coast and Geodetic Survey

The **U.S. Coast and Geodetic Survey** was founded in 1807 when Congress passed a resolution authorizing a sur-

vey of the coast, harbors, outlying islands, and fishing banks of the United States. President Thomas Jefferson appointed Ferdinand Hassler, a Swiss immigrant and professor of mathematics at West Point, the first Director of the "Survey of the Coast." The name was changed to the "U.S. Coast Survey" in 1836.



Figure 117. <https://www.ngs.noaa.gov>

The approaches to New York were the first sections of the coast charted, and from there the work spread northward and southward along the eastern seaboard. In 1844 the work was expanded and arrangements made to simultaneously chart the gulf and east coasts. Investigation of tidal conditions began, and in 1855 the first tables of tide predictions were published. The California gold rush necessitated a survey of the west coast, which began in 1850, the year California became a state. *Coast Pilots*, or *Sailing Direc-*

tions, for the Atlantic coast of the United States were privately published in the first half of the 19th century. In 1850 the Survey began accumulating data that led to federally produced *Coast Pilots*. The 1889 *Pacific Coast Pilot* was an outstanding contribution to the safety of west coast shipping.

In 1878 the survey was renamed “Coast and Geodetic Survey.” In 1970 the survey became the “National Ocean Survey,” and in 1983 it became the “National Ocean Service” (NOS). Under NOS, the Office of Charting and Geodetic Services accomplished all charting and geodetic functions. In 1991 the name was changed back to the original “Coast and Geodetic Survey,” organized under the National Ocean Service along with several other environmental offices. In 1995 the topographic and hydrographic components of the Coast and Geodetic Survey were separated and became the “National Geodetic Survey” (NGS) and the “Office of Coast Survey,” (OCS). The Center for Operational Oceanographic Products and Services (CO-OPS) was also established. All three of these organizations are now part of NOS.

Today OCS supports safe and efficient navigation by maintaining over 1,000 nautical charts and Coast Pilots for U.S. coasts and the Great Lakes, covering 95,000 miles of shoreline and 3.4 million square nautical miles of waters. The charts are distributed in a variety of formats, which include electronic navigational charts (ENCs), raster navigational charts (RNCs), print on demand (POD) paper charts, and a digital chart tile service.

NGS provides shoreline surveys, which OCS compiles onto its nautical charts, and also maintains the National Geodetic Reference System. CO-OPS provides tides, water levels, currents and other oceanographic information that are used directly by mariners, as well as part of the hydrographic surveys and chart production processes that OCS carries out.

118. The National Geospatial-Intelligence Agency

In the first years of the newly formed United States of America, charts and instruments used by the Navy and merchant mariners were left over from colonial days or were obtained from European sources. In 1830 the U.S. Navy established a “Depot of Charts and Instruments” in Washington, D.C., as a storehouse from which available charts, pilots and sailing directions, and navigational instruments were issued to Naval ships. Lieutenant L. M. Goldsborough and one assistant, Passed Midshipman R. B. Hitchcock, constituted the entire staff.

The first chart published by the Depot was produced from data obtained in a survey made by Lieutenant Charles Wilkes, who had succeeded Goldsborough in 1834. Wilkes later earned fame as the leader of a United States expedition to Antarctica. From 1842 until 1861 Lieutenant Matthew Fontaine Maury served as Officer in Charge. Under his command the Depot rose to international prominence.

Maury decided upon an ambitious plan to increase the mariner’s knowledge of existing winds, weather, and currents. He began by making a detailed record of pertinent matter included in old log books stored at the Depot. He then inaugurated a hydrographic reporting program among ship masters, and the thousands of reports received, along with the log book data, were compiled into the “*Wind and Current Chart of the North Atlantic*” in 1847. This is the ancestor of today’s pilot chart.



Figure 118. <https://www.nga.mil>

The United States instigated an international conference in 1853 to interest other nations in a system of exchanging nautical information. The plan, which was Maury’s, was enthusiastically adopted by other maritime nations. In 1854 the Depot was redesignated the “U.S. Naval Observatory and Hydrographical Office.” At the outbreak of the American Civil War in 1861, Maury, a native of Virginia, resigned from the U.S. Navy and accepted a commission in the Confederate Navy. This effectively ended his career as a navigator, author, and oceanographer. At war’s end, he fled the country, his reputation suffering from his embrace of the Confederate cause.

After Maury’s return to the United States in 1868, he served as an instructor at the Virginia Military Institute. He continued at this position until his death in 1873. Since his death, his reputation as one of America’s greatest hydrographers has been restored.

In 1866 Congress separated the Observatory and the Hydrographic Office, broadly increasing the functions of the latter. The Hydrographic Office was authorized to carry out surveys, collect information, and print every kind of nautical chart and publication “for the benefit and use of navigators generally.”

The Hydrographic Office purchased the copyright of *The New American Practical Navigator* in 1867. The first *Notice to Mariners* appeared in 1869. Daily broadcast of navigational warnings was inaugurated in 1907. In 1912, following the sinking of the *Titanic*, the International Ice Patrol was established.

In 1962 the U.S. Navy Hydrographic Office was redesignated the U.S. Naval Oceanographic Office. In 1972 certain hydrographic functions of the latter office were transferred to the Defense Mapping Agency Hydrographic Center. In 1978 the Defense Mapping Agency Hydrographic/Topographic Center (DMAHTC) assumed hydrographic and topographic chart production functions. In 1996 the

National Imagery and Mapping Agency (NIMA) was formed from DMA and certain other elements of the Department of Defense. In 2003 NIMA changed its name to **National Geospatial-Intelligence Agency (NGA)** to reflect its changing primary GEOINT mission. NGA continues to produce charts and nautical publications and to disseminate maritime safety information in support of the U.S. military and navigators generally.

119. The United States Coast Guard

Alexander Hamilton established the **U.S. Coast Guard** as the Revenue Marine, later the Revenue Cutter Service, on August 4, 1790. It was charged with enforcing the customs laws of the new nation. A revenue cutter, the *Harriet Lane*, fired the first shot from a naval unit in the Civil War at Fort Sumter. The Revenue Cutter Service became the U.S. Coast Guard when combined with the Lifesaving Service in 1915. The Lighthouse Service was added in 1939, and the Bureau of Marine Inspection and Navigation was added in 1942. The Coast Guard was transferred from the Treasury Department to the Department of Transportation in 1967, and in March of 2003 transferred to the Department of Homeland Security.



Figure 119. <http://www.uscg.mil>

The primary functions of the Coast Guard include maritime search and rescue, law enforcement, and operation of the nation's aids to navigation system. In addition, the Coast Guard is responsible for port safety and security, merchant marine inspection, and marine pollution control. The Coast Guard operates a large and varied fleet of ships, boats, and aircraft in performing its widely ranging duties.

Navigation systems operated by the Coast Guard include the system of some 40,000 lighted and unlighted beacons, buoys, and ranges in U.S. and territorial waters; differential GPS (DGPS) services in the U.S.; and Vessel Traffic Services (VTS) in major ports and harbors of the U.S.

120. The United States Navy

The **U.S. Navy** was officially established in 1798. Its role in the development of navigational technology has been singular. From the founding of the Naval Observatory to the development of the most advanced electronics, the U.S. Navy has been a leader in developing devices and techniques

designed to make the navigator's job safer and easier.



Figure 120. <http://www.navy.mil>

The development of almost every device known to navigation science has been deeply influenced by Naval policy. Some systems are direct outgrowths of specific Naval needs; some are the result of technological improvements shared with other services and with commercial maritime industry.

121. The United States Naval Observatory

One of the first observatories in the United States was built in 1831-1832 at Chapel Hill, N.C. The Depot of Charts and Instruments, established in 1830, was the agency from which the U.S. Navy Hydrographic Office and the **U.S. Naval Observatory** evolved 36 years later. In about 1835, under Lieutenant Charles Wilkes, the second Officer in Charge, the Depot installed a small transit instrument for rating chronometers.



Figure 121. <http://www.usno.navy.mil/USNO>

The Mallery Act of 1842 provided for the establishment of a permanent observatory. The director was authorized to purchase everything necessary to continue astronomical study. The observatory was completed in 1844 and the results of its first observations were published two years later. Congress established the Naval Observatory as a separate agency in 1866. In 1873 a refracting telescope with a 26 inch aperture, then the world's largest, was installed. The observatory, located in Washington, D.C., has occupied its present site since 1893.

122. The Royal Greenwich Observatory

England had no early privately supported observatories such as those on the continent. The need for navigational advancement was ignored by Henry VIII and Elizabeth I, but in 1675 Charles II, at the urging of John Flamsteed, Jonas Moore, Le Sieur de Saint Pierre, and Christopher Wren,

established the **Greenwich Royal Observatory**. Charles limited construction costs to £500, and appointed Flamsteed the first Astronomer Royal, at an annual salary of £100. The equipment available in the early years of the observatory consisted of two clocks, a “sextant” of 7 foot radius, a quadrant of 3 foot radius, two telescopes, and the star catalog published almost a century before by Tycho Brahe. Thirteen years passed before Flamsteed had an instrument with which he could determine his latitude accurately.



Figure 122. <http://www.rmg.co.uk/royal-observatory>

In 1690 a transit instrument equipped with a telescope and vernier was invented by Romer; he later added a vertical circle to the device. This enabled the astronomer to determine declination and right ascension at the same time. One of these instruments was added to the equipment at Greenwich in 1721, replacing the huge quadrant previously used. The development and perfection of the chronometer in the next hundred years added to the accuracy of observations.

Other national observatories were constructed in the years that followed: at Berlin in 1705, St. Petersburg in 1725, Palermo in 1790, Cape of Good Hope in 1820, Parramatta in New South Wales in 1822, and Sydney in 1855.

123. The International Hydrographic Organization

The **International Hydrographic Organization (IHO)** was originally established in 1921 as the International Hydrographic Bureau (IHB). The present name was adopted in 1970 as a result of a revised international agreement among member nations. However, the former name, International Hydrographic Bureau, was retained for the IHO’s administrative body of three Directors and their staff at the organization’s headquarters in Monaco.



Figure 123. <https://www.iho.int>

The IHO sets forth hydrographic standards to be agreed upon by the member nations. All member states are

urged and encouraged to follow these standards in their surveys, nautical charts, and publications. As these standards are uniformly adopted, the products of the world’s hydrographic and oceanographic offices become more uniform. Much has been done in the field of standardization since the Bureau was founded.

The principal work undertaken by the IHO is:

- to bring about a close and permanent association between national hydrographic offices;
- to study matters relating to hydrography and allied sciences and techniques;
- to further the exchange of nautical charts and documents between hydrographic offices of member governments;
- to circulate the appropriate documents;
- to tender guidance and advice upon request, in particular to countries engaged in setting up or expanding their hydrographic service;
- to encourage coordination of hydrographic surveys with relevant oceanographic activities;
- to extend and facilitate the application of oceanographic knowledge for the benefit of navigators; and
- to cooperate with international organizations and scientific institutions which have related objectives.

During the 19th century, many maritime nations established hydrographic offices to provide means for improving the navigation of naval and merchant vessels by providing nautical publications, nautical charts, and other navigational services. There were substantial differences in hydrographic procedures, charts, and publications. In 1889, an International Marine Conference was held at Washington, D.C., and it was proposed to establish a “permanent international commission.” Similar proposals were made at the sessions of the International Congress of Navigation held at St. Petersburg in 1908 and again in 1912.

In 1919 the hydrographers of Great Britain and France cooperated in taking the necessary steps to convene an international conference of hydrographers. London was selected as the most suitable place for this conference, and on July 24, 1919, the First International Conference opened, attended by the hydrographers of 24 nations. The object of the conference was “To consider the advisability of all maritime nations adopting similar methods in the preparation, construction, and production of their charts and all hydrographic publications; of rendering the results in the most convenient form to enable them to be readily used; of instituting a prompt system of mutual exchange of hydrographic information between all countries; and of providing an opportunity to consultations and discussions to be carried out on hydrographic subjects generally by the hydrographic experts of the world.” This is still the major purpose of the International Hydrographic Organization.

As a result of the conference, a permanent organization was formed and statutes for its operations were prepared. The

International Hydrographic Bureau, now the International Hydrographic Organization, began its activities in 1921 with 18 nations as members. The Principality of Monaco was selected because of its easy communication with the rest of the world and also because of the generous offer of Prince Albert I of Monaco to provide suitable accommodations for the Bureau in the Principality. There are currently 59 member governments. Technical assistance with hydrographic matters is available through the IHO to member states requiring it.

Many IHO publications are available to the general public, such as the International Hydrographic Review, International Hydrographic Bulletin, Chart Specifications of the IHO, Hydrographic Dictionary, and others. Inquiries should be made to the International Hydrographic Bureau, 7 Avenue President J. F. Kennedy, B.P. 445, MC98011, Monaco, CEDEX.

124. The International Maritime Organization

The **International Maritime Organization (IMO)** was established by United Nations Convention in 1948. The Convention actually entered into force in 1959, although an international convention on marine pollution was adopted in 1954. (Until 1982 the official name of the organization was the Inter-Governmental Maritime Consultative Organization.) It is the only permanent body of the U. N. devoted to maritime matters, and the only special U. N. agency to have its headquarters in the UK.



Figure 124. <http://www.imo.org>

The governing body of the IMO is the **Assembly** of 137 member states, which meets every two years. Between Assembly sessions a Council, consisting of 32 member governments elected by the Assembly, governs the organization. Its work is carried out by the Maritime Safety Committee, with subcommittees for:

- Safety of Navigation
- Radiocommunications
- Life-saving
- Search and Rescue
- Training and Watchkeeping
- Carriage of Dangerous Goods
- Ship Design and Equipment
- Fire Protection
- Stability and Load Lines/Fishing Vessel Safety
- Containers and Cargoes
- Bulk Chemicals
- Marine Environment Protection Committee

- Legal Committee
- Technical Cooperation Committee
- Facilitation Committee

IMO is headed by the Secretary General, appointed by the council and approved by the Assembly. He or she is assisted by some 300 civil servants.

To achieve its objectives of coordinating international policy on marine matters, the IMO has adopted some 30 conventions and protocols, and adopted over 700 codes and recommendations. An issue to be adopted first is brought before a committee or subcommittee, which submits a draft to a conference. When the conference adopts the final text, it is submitted to member governments for ratification. Ratification by a specified number of countries is necessary for adoption; the more important the issue, the more countries must ratify. Adopted conventions are binding on member governments.

Codes and recommendations are not binding, but in most cases are supported by domestic legislation by the governments involved.

The first and most far-reaching convention adopted by the IMO was the International Convention for the **Safety of Life at Sea (SOLAS)** in 1960. This convention actually came into force in 1965, replacing a version first adopted in 1948. Because of the difficult process of bringing amendments into force internationally, none of subsequent amendments became binding. To remedy this situation, a new convention was adopted in 1974 and became binding in 1980. Among the regulations is V-20, requiring the carriage of up-to-date charts and publications sufficient for the intended voyage.

Other conventions and amendments were also adopted, such as the International Convention on Load Lines (adopted 1966, came into force 1968), a convention on the tonnage measurement of ships (adopted 1969, came into force 1982), The International Convention on Safe Containers (adopted 1972, came into force 1977), and the convention on **International Regulations for Preventing Collisions at Sea (COLREGS)** (adopted 1972, came into force 1977).

The 1972 COLREGS convention contained, among other provisions, a section devoted to Traffic Separation Schemes, which became binding on member states after having been adopted as recommendations in prior years.

One of the most important conventions is the **International Convention for the Prevention of Pollution from Ships (MARPOL 73/78)**, which was first adopted in 1973, amended by Protocol in 1978, and became binding in 1983. This convention built on a series of prior conventions and agreements dating from 1954, highlighted by several severe pollution disasters involving oil tankers. The MARPOL convention reduces the amount of oil discharged into the sea by ships, and bans discharges completely in certain areas. A related convention known as the London Dumping Convention regulates dumping of hazardous chemicals and other debris into the sea.

The IMO also develops minimum performance standards for a wide range of equipment relevant to safety at sea. Among such standards is one for the **Electronic Chart Display and Information System (ECDIS)**, the digital display deemed the operational and legal equivalent of the conventional paper chart.

Texts of the various conventions and recommendations, as well as a catalog and publications on other subjects, are available from the Publications Section of the IMO at 4 Albert Embankment, London SE1 7SR, United Kingdom.

125. The International Association of Marine Aids to Navigation and Lighthouse Authorities

The **International Association of Marine Aids to Navigation and Lighthouse Authorities (IALA)** brings together representatives of the aids to navigation services of more than 80 member countries for technical coordination, information sharing, and coordination of improvements to visual aids to navigation throughout the world. It was established in 1957 to provide a permanent organization to support the goals of the Technical Lighthouse Conferences, which had been convening since 1929. The General Assembly of IALA meets about every 4 years. The Council of 20 members meets twice a year to oversee the ongoing programs.



Figure 125. <http://www.iala-aism.org>

Five technical committees maintain the permanent programs:

- The Marine Marking Committee
- The Radionavigation Systems Committee
- The Vessel Traffic Services (VTS) Committee
- The Reliability Committee
- The Documentation Committee

IALA committees provide important documentation to the IHO and other international organizations, while the IALA Secretariat acts as a clearing house for the exchange of technical information, and organizes seminars and technical support for developing countries.

Its principle work since 1973 has been the implementation of the IALA Maritime Buoyage System described in [Chapter 7- Short Range Aids to Navigation](#). This system replaced some 30 dissimilar buoyage systems in use throughout the world with 2 major systems.

IALA is based near Paris, France in Saint-Germaine-en-Laye.

126. The Radio Technical Commission for Maritime Services (RTCM)

The **Radio Technical Commission for Maritime Services** is a non-profit organization which serves as a focal point for the exchange of information and the development of recommendations and standards related to all aspects of maritime radiocommunications and radionavigation.



Figure 126. <http://www.rtcn.org>

Specifically, RTCM:

- Promotes ideas and exchanges information on maritime radiocommunications and radionavigation.
- Facilitates the development and exchange of views among and between government and non-government interests both nationally and internationally.
- Conducts studies and prepares reports on maritime radiocommunications and radionavigation issues to improve efficiency and capabilities.

Both government and non-government organizations are members, coming from the U.S. and many other nations. The RTCM organization consists of a Board of Directors, and the Assembly consisting of all members, officers, staff, technical advisors, and working committees.

Working committees are formed as needed to develop official RTCM recommendations regarding technical standards and regulatory policies in the maritime field. Currently committees address such issues as maritime safety information, electronic charts, emergency position-indicating radiobeacons (EPIRB's), personal locator beacons, ship radars, differential GPS, GLONASS (Russia's version of GPS), and maritime survivor locator devices.

The RTCM headquarters office is in Alexandria, VA.

127. The National Marine Electronic Association

The **National Marine Electronic Association (NMEA)** is a professional trade association founded in 1957 whose purpose is to coordinate the efforts of marine electronics manufacturers, technicians, government agencies, ship and boat builders, and other interested groups. In addition to certifying marine electronics technicians and professionally recognizing outstanding achievements by corporate and individual members, the NMEA sets standards for the exchange of digital data by all manufacturers

of marine electronic equipment. This allows the configuration of integrated navigation system using equipment from different manufacturers.



Figure 127. <http://www.nmea.org>

NMEA works closely with RTCM and other private organizations and with government agencies to monitor the status of laws and regulations affecting the marine electronics industry.

It also sponsors conferences and seminars, and publishes a number of guides and periodicals for members and the general public.

128. International Electrotechnical Commission

The **International Electrotechnical Commission (IEC)** was founded in 1906 as an outgrowth of the International Electrical Congress held at St. Louis, Missouri in 1904. Some 60 countries are active members. Its mission is to develop and promote standardization in the technical specifications of electrical and electronic equipment among all nations. These technologies include electronics, magnetics, electromagnetics, electroacoustics, multimedia, telecommunications, electrical energy production and dis-

tribution, and associated fields such as terminology and symbology, compatibility, performance standards, safety, and environmental factors.



Figure 128. <http://www.iec.ch>

By standardizing in these areas, the IEC seeks to promote more efficient markets, improve the quality of products and standards of performance, promote interoperability, increase production efficiency, and contribute to human health and safety and environmental protection.

Standards are published by the IEC in the form of official IEC documents after debate and input from the national committees. Standards thus represent a consensus of the views of many different interests. Adoption of a standard by any country is entirely voluntary. However, failure to adopt a standard may result in a technical barrier to trade, as goods manufactured to a proprietary standard in one country may be incompatible with the systems of others.

IEC standards are vital to the success of ECDIS and other integrated navigation systems because they help to ensure that systems from various manufacturers in different countries will be compatible and meet required specifications.

CHAPTER 2

GEODESY AND DATUMS IN NAVIGATION

GEODESY, THE BASIS OF CARTOGRAPHY

200. Definition

Geodesy is the application of mathematics to model the size and shape of the physical earth, enabling us to describe its magnetic and gravitational fields and a coordinate referencing system to precisely position and navigate globally using one 3-dimensional coordinate system.

Today's modern Global Navigation Satellite Systems (GNSS), such as GPS, have made it possible to establish a truly global geocentric reference system which can be quickly adapted for precise positioning and navigation over long distances.

Thus, the precision of today's navigation systems and the global nature of satellite and other long-range positioning methods demand a more complete understanding of geodesy by the navigator than has ever before been required.

201. The Shape of the Earth

In geodetic applications, three primary reference surfaces for the Earth are used (See Table 201):

1. a **physical surface**,
2. an **ellipsoid of revolution**, which is a reference surface of purely mathematical nature, and
3. the **geoid** (an irregular surface, which has no complete mathematical expression).

A physical surface is tangible, it can be traversed and measurements can be made on it. The topography, ice caps, or sea surface area all physical surfaces.

An equipotential surface is one where the force of gravity is always equal and the direction of gravity is always perpendicular. The **geoid** is a particular equipotential surface that would coincide with the mean ocean surface of the Earth if the oceans and atmosphere were in equilibrium, at rest relative to the rotating Earth, and extended through the continents (such as with very narrow canals).

In common practice, an **ellipsoid height** is the distance a given point is above or below the ellipsoid surface, whereas a **geoid height** is the distance the geoid surface is above or below the ellipsoid surface. Determination of a "mean

sea level" is a difficult problem because of the many factors that affect sea level. Sea level varies considerably on several scales of time and distance and the extent of this variability is the result of seas that are in constant motion, affected by the solar and lunar tides, wind, atmospheric pressure, local gravitational differences, temperature, and salinity. In geodetic applications, the geoid is then used to serve as the vertical reference surface to approximate measure mean sea level (MSL) heights and a height measured from the geoid to a point is called an **orthometric height**. In areas where elevation data are not available from conventional geodetic leveling, an approximation of MSL heights using orthometric heights from the geoid can be obtained from the equation listed in Table 201. This equation

$H = h - N$
where
H = orthometric height (the height relative to the geoid)
h = ellipsoid (geodetic) height (the height relative to the ellipsoid)
N = geoid height (undulation)

Table 201. Relations between orthometric, ellipsoid and geoid heights.

illustrates the determination of the orthometric height (H) of a point as a subtraction of the geoid height (N) from the ellipsoid height (h).

202. Defining the Ellipsoid

An **ellipsoid** is uniquely defined by specifying two parameters. Geodesists, by convention, use the **semi-major axis** and either **eccentricity** or **flattening**. The size is represented by the radius at the equator, the semi-major axis. The shape of the ellipsoid is given by the flattening, which indicates how closely an ellipsoid approaches a spherical shape. The flattening (f) is the ratio of the difference between the semi-major (a) and semi-minor (b) axes of the ellipsoid and the semi-major axis.

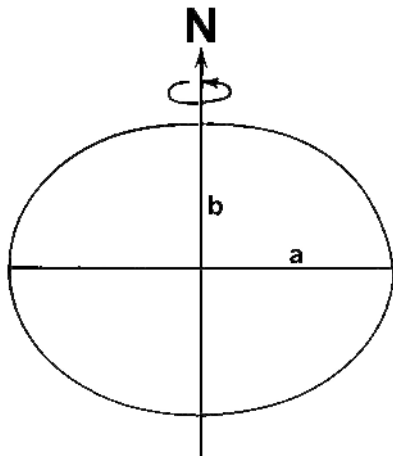

Figure 202. An ellipsoid of revolution, with semimajor axis (a), and semiminor axis (b).

$$f = \frac{a - b}{a}$$

The ellipsoidal Earth model has its minor axis parallel to the Earth's polar axis. Rotating the ellipse about the semi-minor axis gives the ellipsoid of revolution. See Figure 202.

203. Ellipsoids and the Geoid as Reference Surfaces

Since the surface of the geoid is irregular and the surface of an ellipsoid is regular, no ellipsoid can provide more than an approximation of part of the geoidal surface. Historically, ellipsoids that best fit the geoid regionally were employed. The widespread use of GNSS has facilitated the use of global, best fitting ellipsoids. The most common are the World Geodetic System 1984 (WGS 84) and the Geodetic Reference System of 1980 (GRS 80) ellipsoids. See

Parameter	Symbol	Value	Units
Semi-major Axis (Equatorial Radius of the Earth)	a	6378137.0	m
Flattening factor of the Earth	1/f	298.257223563	
Geocentric Gravitational Constant	GM	$3.986004418 \times 10^{14}$	m^3/s^2
Nominal Mean Angular Velocity of the Earth	ω	7.292115×10^{-5}	rads / s

Table 203. WGS 84 defining parameters.

Table 203 for WGS 84 defining parameters.

204. Coordinates

The **astronomic latitude** is the angle between a plumb line and the plane of the celestial equator. It is the latitude which results directly from observations of celestial bodies, uncorrected for deflection of the vertical component in the meridian (north-south) direction. Astronomic latitude applies only to positions on the Earth. It is reckoned from the astronomic equator (0°), north and south through 90°.

The **astronomic longitude** is the angle between the plane of the celestial meridian at a station and the plane of the celestial meridian at Greenwich. It is the longitude which results directly from observations of celestial bodies, uncorrected for deflection of the vertical component in the prime vertical (east-west) direction. These are the coordinates observed by the celestial navigator using a sextant and a very accurate clock based on the Earth's rotation.

Celestial observations by geodesists are made with

optical instruments (theodolite, zenith camera, prismatic astrolabe) which all contain leveling devices. When properly adjusted, the vertical axis of the instrument coincides with the direction of gravity, which may not coincide with the plane of the meridian. Thus, geodetically derived astronomic positions are referenced to the geoid. The difference, from a navigational standpoint, is too small to be of concern.

The **geodetic latitude** is the angle which the normal to the ellipsoid at a station makes with the plane of the geodetic equator. In recording a geodetic position, it is essential that the geodetic datum on which it is based also be stated. A geodetic latitude differs from the corresponding astronomic latitude by the amount of the meridian component of the local **deflection of the vertical**. See Figure 204.

The **geodetic longitude** is the angle between the plane of the geodetic meridian at a station and the plane of the geodetic meridian at Greenwich. A geodetic longitude differs from the corresponding astronomic longitude by the prime vertical component of the local deflection of the

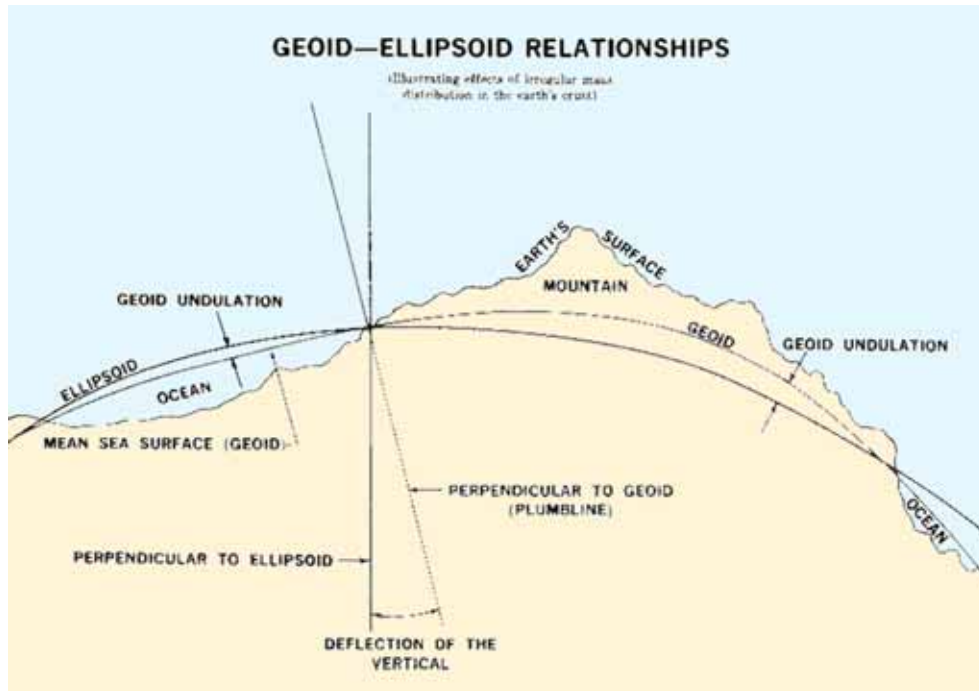

Figure 204. Geoid-ellipsoid relationships.

vertical divided by the cosine of the latitude. The geodetic coordinates are used for mapping.

The **geocentric latitude** is the angle at the center of the ellipsoid (used to represent the Earth) between the plane of the equator, and a straight line (or radius vector) to a point on the surface of the ellipsoid. This differs from geodetic latitude because the Earth is approximated more closely by a spheroid than a sphere and the meridians are ellipses, not perfect circles.

Both geocentric and geodetic latitudes refer to the reference ellipsoid and not the Earth. Since the parallels of latitude are considered to be circles, geodetic longitude is geocentric, and a separate expression is not used.

Because of the oblate shape of the ellipsoid, the length

of a degree of geodetic latitude is not everywhere the same, increasing from about 59.7 nautical miles at the equator to about 60.3 nautical miles at the poles.

A classic regional **horizontal geodetic datum** usually consists of the astronomic and geodetic latitude, and astronomic and geodetic longitude of an initial point (origin); an azimuth of a line (direction); the parameters (radius and flattening) of the ellipsoid selected for the computations; and the geoidal separation at the origin. A change in any of these quantities affects every point on the datum.

For this reason, while positions within a given datum are directly and accurately relatable, those from different datums must be transformed to a common datum for consistency.

TYPES OF GEODETIC SURVEY

205. Satellite Positioning

The use of artificial satellite signals allows positioning without the necessity of line-of-sight. Positions (including heights) determined in this manner are *directly* referred to the ellipsoid. Static precise positioning is commonly employed to determine or extend geodetic control.

Absolute positioning uses a single stationary receiver to determine a position with respect to the center of the Earth. Relative static positioning determines a position with respect to another station and involves multiple receivers

operating simultaneously. Specialized processing is required for these highly accurate survey methods.

The position of a moving receiver often depends on a reference receiver at a known point that broadcasts corrections in some fashion. The corrections are derived from the difference between the known position of the base and the position determined by the current constellation.

The electro-optical survey methods discussed following this section on satellite positioning must be *reduced* to the ellipsoid for computations.

206. Triangulation

The most common type of geodetic survey is known as **triangulation**. Triangulation consists of the measurement of the angles of a series of triangles. The principle of triangulation is based on plane trigonometry. If the distance along one side of the triangle and the angles at each end are accurately measured, the other two sides and the remaining angle can be computed. In practice, all of the angles of every triangle are measured to provide precise measurements. Also, the latitude and longitude of one end of the measured side along with the length and direction (azimuth) of the side provide sufficient data to compute the latitude and longitude of the other end of the side.

The measured side of the base triangle is called a **baseline**. Measurements are made as carefully and accurately as possible with specially calibrated tapes or wires of Invar, an alloy with a very low coefficient of expansion. The tape or wires are checked periodically against standard measures of length.

To establish an arc of triangulation between two widely separated locations, the baseline may be measured and longitude and latitude determined for the initial points at each location. The lines are then connected by a series of adjoining triangles forming quadrilaterals extending from each end. All angles of the triangles are measured repeatedly to reduce errors. With the longitude, latitude, and azimuth of the initial points, similar data is computed for each vertex of the triangles, thereby establishing triangulation stations, or geodetic control stations. The coordinates of each of the stations are defined as geodetic coordinates.

Triangulation is extended over large areas by connecting and extending series of arcs to form a network or triangulation system. The network is adjusted so as to reduce observational errors to a minimum. A denser distribution of geodetic control is achieved by subdividing or filling in with other surveys.

There are four general classes or orders of triangulation. **First-order** (primary) triangulation is the most precise and exact type. The most accurate instruments and rigorous computation methods are used. It is costly and time-consuming, and is usually used to provide the basic framework of control data for an area, and the determination of the figure of the Earth. The most accurate first-order surveys furnish control points which can be interrelated with an accuracy ranging from 1 part in 25,000 over short distances to approximately 1 part in 100,000 for long distances.

Second-order triangulation furnishes points closer together than in the primary network. While second-order surveys may cover quite extensive areas, they are usually tied to a primary system where possible. The procedures are less exacting and the proportional error is 1 part in 10,000.

Third-order triangulation is run between points in a secondary survey. It is used to densify local control nets and

position the topographic and hydrographic detail of the area. Error can amount to 1 part in 5,000.

The sole accuracy requirement for **fourth-order** triangulation is that the positions be located without any appreciable error on maps compiled on the basis of the control. Fourth-order control is done primarily as mapping control.

207. Trilateration, Traverse, And Vertical Surveying

Trilateration involves measuring the sides of a chain of triangles or other polygons. From them, the distance and direction from A to B can be computed. Figure 207 shows this process.

Traverse involves measuring distances and the angles between them without triangles for the purpose of computing the distance and direction from A to B. See Figure 207.

Vertical surveying is the process of determining elevations above mean sea-level. In geodetic surveys executed primarily for mapping, geodetic positions are referred to an ellipsoid, and the elevations of the positions are referred to the geoid. However, for satellite geodesy the geoidal heights must be considered to establish the correct height above the geoid.

Precise geodetic **leveling** is used to establish a basic network of vertical control points. From these, the height of other positions in the survey can be determined by supplementary methods. The mean sea-level surface used as a reference (vertical datum) is determined by averaging the hourly water heights for a specified period of time at specified tide gauges.

There are three leveling techniques: **differential**, **trigonometric**, and **barometric**. Differential leveling is the most accurate of the three methods. With the instrument locked in position, readings are made on two calibrated staffs held in an upright position ahead of and behind the instrument. The difference between readings is the difference in elevation between the points.

Trigonometric leveling involves measuring a vertical angle from a known distance with a theodolite and computing the elevation of the point. With this method, vertical measurement can be made at the same time horizontal angles are measured for triangulation. It is, therefore, a somewhat more economical method but less accurate than differential leveling. It is often the only mechanical method of establishing accurate elevation control in mountainous areas.

In barometric leveling, differences in height are determined by measuring the differences in atmospheric pressure at various elevations. Air pressure is measured by mercurial or aneroid barometer, or a boiling point thermometer. Although the accuracy of this method is not as great as either of the other two, it obtains relative heights very rapidly at points which are fairly far apart. It is used in reconnaissance and exploratory surveys where more accurate measurements will be made later or where a high degree of accuracy is not required.

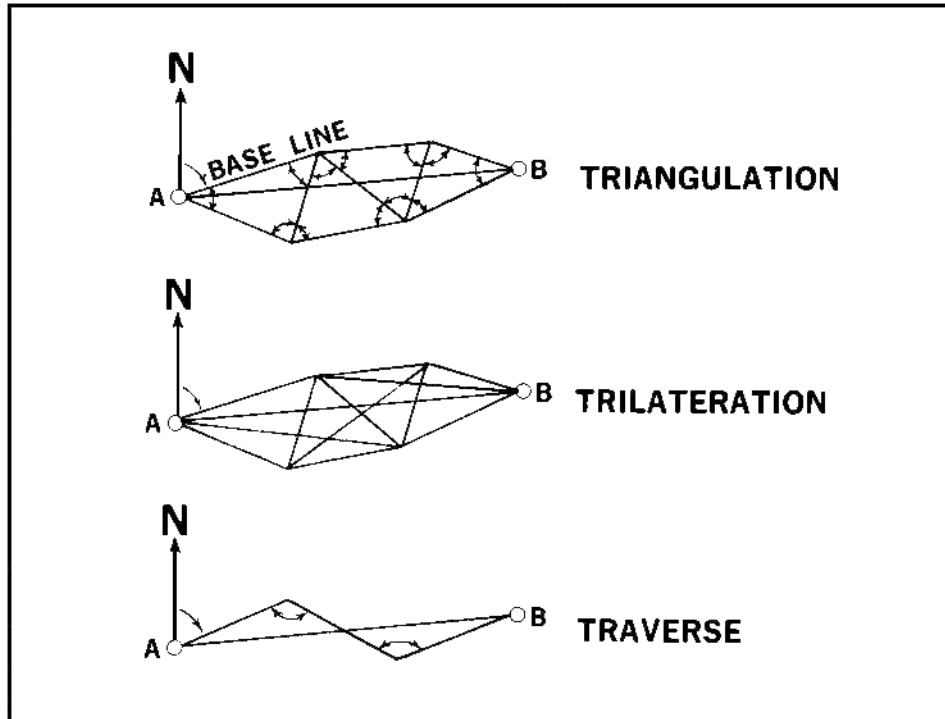

Figure 207. Triangulation, trilateration, and traverse.

MODERN GEODETIC SYSTEMS

208. Development of the World Geodetic System

By the late 1950's the increasing range and sophistication of weapons systems had rendered local or national datums inadequate for military purposes; these new weapons required datums at least continental, if not global, in scope. In response to these requirements, the U.S. Department of Defense generated a geocentric (earth-centered) reference system to which different geodetic networks could be referred, and established compatibility between the coordinate systems. Efforts of the Army, Navy, and Air Force were combined, leading to the development of the DoD **World Geodetic System of 1960 (WGS 60)**.

In January 1966, a World Geodetic System Committee was charged with the responsibility for developing an improved WGS needed to satisfy mapping, charting, and geodetic requirements. Additional surface gravity observations, results from the extension of triangulation and trilateration networks, and large amounts of Doppler and optical satellite data had become available since the development of WGS 60. Using the additional data and improved techniques, the Committee produced **WGS 66** which served DoD needs following its implementation in 1967.

The same World Geodetic System Committee began work in 1970 to develop a replacement for WGS 66. Since the

development of WGS 66, large quantities of additional data had become available from both Doppler and optical satellites, surface gravity surveys, triangulation and trilateration surveys, high precision traverses, and astronomic surveys.

In addition, improved capabilities had been developed in both computers and computer software. Continued research in computational procedures and error analyses had produced better methods and an improved facility for handling and combining data. After an extensive effort extending over a period of approximately three years, the Committee completed the development of the Department of Defense **World Geodetic System 1972 (WGS 72)**.

Further refinement of WGS 72 resulted in the new **World Geodetic System of 1984 (WGS 84)**, now referred to as simply WGS. For surface navigation, WGS 60, 66, 72 and the new WGS 84 are essentially the same, so that positions computed on any WGS coordinates can be plotted directly on the others without correction.

The WGS system is not based on a single point, but many points, fixed with extreme precision by satellite fixes and statistical methods. The result is an ellipsoid which fits the real surface of the Earth, or geoid, far more accurately than any other. The WGS system is applicable worldwide. All regional datums can be referenced to WGS once a survey tie has been made.

209. The North American Datum Of 1983

The Office of Coast Survey of the National Ocean Service (NOS), NOAA, is responsible for charting United States waters. From 1927 to 1987, U.S. charts were based on North American Datum 1927 (NAD 27), using the Clarke 1866 ellipsoid. In 1989, the U.S. officially switched to **NAD 83** (navigationally equivalent to WGS) for all mapping and charting purposes, and all new NOAA chart production is based on this new standard.

The grid of interconnected surveys which criss-crosses the United States consists of some 250,000 control points, each consisting of the latitude and longitude of the point, plus additional data such as elevation. Converting the NAD 27 coordinates to NAD 83 involved recomputing the position of each point based on the new NAD 83 datum. In addition to the 250,000 U.S. control points, several thousand more were added to tie in surveys from Canada, Mexico, and Central America.

Conversion of new edition charts to the new datums, either WGS 84 or NAD 83, involves converting reference points on each chart from the old datum to the new, and adjusting the latitude and longitude grid (known as the graticule) so that it reflects the newly plotted positions. This adjustment of the graticule is the only difference between charts which differ only in datum. All charted features remain in exactly the same relative positions.

The Global Positioning System (GPS) has transformed the science of surveying, enabling the establishment of precise ties to WGS in areas previously found to be too remote to survey to modern standards. As a result, new charts are increasingly precise as to position of features. The more recent a chart's date of publishing, the more likely it is that it will be accurate as to positions. Navigators should always refer to the title block of a chart to determine the date of the chart, the date of the surveys and sources used to compile it, and the datum on which it is based.

DATUMS AND NAVIGATION

210. Datum Shift

One of the most serious impacts of different datums on navigation occurs when a navigation system provides a fix based on a datum *different* from that used for the nautical chart. The resulting plotted position may be different from the actual location on that chart. This difference is known as a **datum shift**.

Modern electronic navigation systems have software installed that can output positions in a variety of datums, eliminating the necessity for applying corrections. All electronic charts produced by NGA are compiled on WGS and are not subject to datum shift problems as long as the GPS receiver is outputting WGS position data to the display system. The same is true for NOAA charts of the U.S., which are compiled on NAD 83 datum, very closely related to WGS. GPS receivers default to WGS, so that no action is necessary to use any U.S.-produced electronic charts.

To automate datum conversions, a number of datum transformation software programs have been written that will convert from any known datum to any other, in any location. MSPGEOTRANS is such a program. The amount of datum shift between two different datums is not linear. That is, the amount of shift is a function of the position of the observer, which must be specified for the shift to be computed. Varying differences of latitude and longitude between two different datums will be noted as one's location changes.

There are still a few NGA-produced paper charts, and a number of charts from other countries, based on datums other than WGS. If the datum of these charts is noted in the title block of the chart, most GPS receivers can be set to output position data in that datum, eliminating the datum shift

problem. If the datum is not listed, extreme caution is necessary. An offset can sometimes be established if the ship's actual position can be determined with sufficient accuracy, and this offset applied to GPS positions in the local area. But remember that since a datum shift is not linear, this offset is only applicable locally.

Another effect on navigation occurs when shifting between charts that have been compiled using different datums. If a position is replotted on a chart of another datum using latitude and longitude, the newly plotted position will not match with respect to other charted features. The datum shift may be avoided by transferring positions using bearings and ranges to common points. If datum shift conversion notes for the applicable datums are given on the charts, positions defined by latitude and longitude may be replotted after applying the noted correction.

The positions given for chart corrections in the *Notice to Mariners* reflect the proper datum for each specific chart and edition number. Due to conversion of charts based on old datums to more modern ones, and the use of many different datums throughout the world, chart corrections intended for one edition of a chart may not necessarily be safely plotted on any other.

As noted, datum shifts are not constant throughout a given region, but vary according to how the differing datums fit together. For example, the NAD 27 to NAD 83 conversion resulted in changes in latitude of 40 meters in Miami, 11 meters in New York, and 20 meters in Seattle. Longitude changes for this conversion amounted to 22 meters in Miami, 35 meters in New York, and 93 meters in Seattle.

Most charts produced by NGA and NOAA show a "datum note." This note is usually found in the title block

or in the upper left margin of the chart. According to the year of the chart edition, the scale, and policy at the time of production, the note may say “World Geodetic System 1972 (WGS-72)”, “World Geodetic System 1984 (WGS-84)”, or “World Geodetic System (WGS).” A datum note for a chart for which satellite positions can be plotted without correction will read: “Positions obtained from satellite navigation systems referred to (Reference Datum) can be plotted directly on this chart.”

NGA reproductions of foreign charts will usually be in the datum or reference system of the producing country. In these cases a conversion factor is given in the following format: “Positions obtained from satellite navigation systems referred to the (Reference Datum) must be moved X.XX minutes (Northward/Southward) and X.XX minutes (Eastward/ Westward) to agree with this chart.”

Some charts cannot be tied in to WGS because of lack of recent surveys. Currently issued charts of some areas are based on surveys or use data obtained in the Age of Sail. The lack of surveyed control points means that they cannot be properly referenced to modern geodetic systems. In this case there may be a note that says: “Adjustments to WGS cannot be determined for this chart.”

A few charts may have no datum note at all, but may carry a note which says: “From various sources to (year).” In these cases there is no way for the navigator to determine the mathematical difference between the local datum and WGS positions. However, if a radar or visual fix can be accurately determined, and an offset established as noted above. This offset can then be programmed into the GPS receiver.

To minimize problems caused by differing datums:

- Plot chart corrections only on the specific charts and editions for which they are intended. Each chart correction is specific to only one edition of a chart. When the same

correction is made on two charts based on different datums, the positions for the same feature may differ slightly. This difference is equal to the datum shift between the two datums for that area.

- Try to determine the source and datum of positions of temporary features, such as drill rigs. In general they are given in the datum used in the area in question. Since these are precisely positioned using satellites, WGS is the normal datum. A datum correction, if needed, might be found on a chart of the area.
- Remember that if the datum of a plotted feature is not known, position inaccuracies may result. It is wise to allow a margin of error if there is any doubt about the datum.
- Know how the datum of the positioning system you are using relates to your chart. GPS and other modern positioning systems use WGS datum. If your chart is on any other datum, you must program the system to use the chart’s datum, or apply a datum correction when plotting GPS positions on the chart.

For more information regarding geodetic datums visit the link provided in Figure 210.



Figure 210.

http://www.colorado.edu/geography/gcraft/notes/datum/datum_f.html

CHAPTER 3

HYDROGRAPHY

INTRODUCTION

300. Data for Charting

Hydrography is the science of the measurement and description of the features which affect marine navigation, including water depths, shorelines, tides, currents, bottom types, and undersea obstructions. **Cartography** transforms the scientific data collected by hydrographers into data useful to the mariner, and is the final step in a long process that converts raw data into a usable chart.

The mariner, in addition to being the primary user of

hydrographic data, is also an important source of data used in the production and correction of nautical charts. This chapter discusses the processes associated with the planning and execution of a hydrographic survey as well as hydrographic surveying methods, types of survey data, and standards for data validation. With this information, mariners can better understand the information presented on charts, and will be better prepared to report new hydrographic information that may be encountered while underway.

HYDROGRAPHIC SURVEYS

301. Depth Information

All nautical charts contain a foundation of depth information that supports navigation. Hydrographic offices gather this depth information from a wide variety of sources, ranging from ship reports and oceanographic measurements to academic or commercially collected SONAR data, previously compiled charts, and hydrographic surveys. While each of these sources play a critical role in chart compilation, only some hydrographic surveys are designed and executed with nautical charting in mind. It is critical for the mariner to understand how different data sources and survey techniques can impact the degree of seafloor coverage, feature detection, and quality of bathymetric information.

Most modern survey data is collected remotely, using sensors such as SONAR or bathymetric LIDAR (both of which are described in greater detail later in this chapter). This technology allows hydrographers to thoroughly and accurately map sections of the seafloor. However, the sensors that are used today have only been in existence for a few decades. Historical survey methods, which were used for hundreds of years before the invention of modern survey technology, consisted of collecting physical depth measurements with a sounding pole, lead line or wire drag. Although these measurements could be quite accurate, and lead lines and wire drags are still in use for some applications, they do not provide continuous maps of the seafloor, and some features may go undetected. The mariner should understand that in remote or infrequently trafficked areas, much of the information on a nautical chart

may still be reflective of surveys conducted using such antiquated techniques.

Even with the advent of modern technology, there are still many different kinds of surveys, collected for a wide variety of purposes, and not all are equally applicable to nautical charts. Oceanographic institutions and universities may conduct surveys of benthic (i.e. relating to, or occurring at the bottom of a body of water) regions for scientific study and/or oil and mineral exploration companies may collect data for resource identification. Marine archaeologists may survey an area to identify and preserve submerged cultural resources, while commercial fishermen may map the seafloor to identify profitable fishing grounds. Communications companies may create a detailed map of the seafloor to identify an appropriate location for cable deployment. While each of these surveys may be well-suited to their purpose, they may be of variable quality and utility for nautical charting. However, if these surveys are made publicly available, some of this information may be incorporated into nautical charts. Hydrographic offices simply do not have the resources to map the world's oceans using dedicated survey vessels, alone.

Understanding these differences in data sources and survey techniques enables the mariner to make informed voyage planning decisions. It is very important to remember that not all data that is used for chart compilation is of equal quality; the hydrographic office will use the best information available at the time of compilation, but the mariner must understand this variability in underlying data quality and coverage, and exercise prudence. **Source**

diagrams on nautical charts can provide valuable insight into the age and quality of data used in chart compilation.

HYDROGRAPHIC SURVEY PLANNING

302. Considerations

Many countries with hydrographic offices conduct periodic surveys of their national waters to collect data that will improve and update their own navigational products. Hydrographic surveys that are conducted in support of nautical charting gather information about bathymetric data, hazards to mariners, tides and water levels, shoreline, Aids to Navigation, and other oceanographic data that may be important for chart production. These surveys are usually very time and resource-intensive, and so require careful planning, execution, and analysis to ensure that the data collected is accurate and safe for navigation.

A hydrographic survey begins long before actual data collection starts. Hydrographers must identify an area to be surveyed, determine whether a reconnaissance or full scope survey is needed, and then calculate the amount of time needed to execute the survey. They must select the most appropriate survey methodology, locate a platform that is able to collect the data, and arrange logistics, obtain funding and permits, and form a team of qualified surveyors and support personnel.

Once these planning and preparation issues are decided, the hydrographer reviews all available information in the survey area to gather critical information for safely and effectively executing the survey. Satellite or aerial imagery, topographic maps, nautical charts, geodetic information, oceanographic data, past survey data and information from nautical publications are incorporated into a survey plan.

Tidal information is also thoroughly reviewed, and tide gauge locations identified.

With this information in hand, the hydrographer then plans the daily survey operations. When a survey vessel or plane collects data, it is usually collected in a pattern of lines which are predetermined before the survey begins. The scale of the survey, financial resources available, sensor technology, water depth, orientation to the shoreline, method of horizontal and vertical positioning, and the desired level of seafloor coverage all contribute to line planning. The line spacing determines the level of seafloor coverage that the survey will capture.

In an area of critical underkeel clearance, a hydrographer may elect to conduct a high-resolution multibeam sonar survey, with overlapping lines of coverage, to ensure that most significant features are detected. Alternatively, a hydrographer may also execute a combination of non-overlapping singlebeam sonar lines, augmented by full side scan sonar coverage, to image features. In deeper water, where underkeel clearance is less critical, survey data may be collected while the ship is in transit, or in a pattern of lines guided by feature investigation or general depiction of the seafloor, rather than full sea floor coverage.

While there is no “right” answer to survey planning, experienced hydrographers know which combination of sensors, survey plans and resources are best suited to obtaining the desired results in different situations.

HYDROGRAPHIC SURVEY TECHNIQUES

303. Introduction

The earliest depth measurements were collected from sailing vessels using lead lines or sounding poles deployed over the side of the ship. Nautical cartography, positioning, and marine timekeeping have improved greatly over the course of the last several hundred years. Although lead lines and sounding poles are still in limited use, there have been great advances in survey technology. Over the past one hundred years, developments in SONAR, advancements in remote sensing technology, precise positioning and computerized data processing have created a robust body of science dedicated to collecting and analyzing bathymetric information. It is important for the mariner to have a basic understanding of the different techniques employed for collecting depth and seafloor feature information, as any one of these techniques may contribute data to a modern chart.

304. Lead line

The Lead (pronounced *led*) or lead line is a device consisting of a marked line with a lead weight attached to one end. The user deploys the lead line over the side of the survey vessel, and measures the length of line paid out before the lead touches bottom. The line is marked at set intervals in such a way that the user can quickly determine the water depth by examining the amount of line that has been expended (see Table 304). Most lead lines have a hollow in the end of the lead, which can be filled with wax or some other tractive substance, designed to give the user information about the nature of the bottom. In a sandy or muddy area, the lead will return with sand grains or mud embedded in the wax; in a rocky area, nothing will be returned. The nature of the bottom can be depicted on nautical charts, and is helpful information for determining suitable anchoring areas.

Although the concept behind lead line deployment is

<i>Distance from lead in fathoms</i>	<i>Marking</i>	<i>Metric equivalent</i>
2	two strips of leather	3.66
3	three strips of leather	5.49
5	white rag (usually cotton)	9.14
7	red rag (usually wool)	12.80
10	leather with hole	18.29
13	same as three fathoms	23.77
15	same as five fathoms	27.43
17	same as seven fathoms	31.09
20	a line with two knots	36.58
25	a line with one knot	45.72
30	a line with 3 knots	54.86

Table 304. Example of traditional lead line markings.

simple, users should ensure that markings are applied to the line while it is wet, that the markings are periodically measured against a tape to ensure that the line has not stretched or warped (some lines have a wire core to prevent this), and depth measurements should be taken at slack tide to avoid line curvature from currents.

While the lead line is probably the oldest of all navigational aids, it is still a useful device for confirming depths alongside piers, determining the nature of the bottom, and checking the depths around a vessel in the event of grounding.

305. Wire Drag

The wire drag was designed to detect submerged features such as wrecks, rocks and obstructions in nearshore

areas where underkeel clearance is critical. This technique, like the lead line, has been in use for a very long time. The operating principle is simple; two vessels, a given distance apart, move in the same direction dragging a wire between them that has been set to a predetermined depth (see Figure 305). If an obstacle is encountered, it will strike the wire. The surveyors can then raise the wire to determine the least depth of the feature. In this manner, an area can be confidently verified, or 'swept' as free of hazards to a minimum depth. The exact nature and relief of the seafloor is not known, but the surveyors have physically verified that nothing exceeds the least depth of the wire. When a SONAR survey is performed, a post-survey using a wire drag may be conducted as a quality control measure, to ensure that an area is cleared to minimum depth.



Figure 305. Conducting a wire drag. Image courtesy of NOAA.

306. Singlebeam Echosounders

Single beam echo sounders were developed in the early 1920s, and compute the depth of water by measuring the

time it takes for a pulse of sound to travel from the source, to the seafloor, and then back to the source. A device called a transducer, usually mounted on the keel of a vessel, converts electrical energy into sound energy, which then

travels through the water column as a compression wave, reflects off the seafloor and is returned to the sensor. This basic SONAR technology is widely used by private and commercial vessels to verify underkeel clearance and water depth when operating in coastal areas. Survey vessels may also use this technology to collect depth information by following a prescribed pattern of survey lines and collecting measurements directly under the vessel.

Although singlebeam SONAR measurements can be very accurate, the sensors are limited in scope because they provide information about only a narrow footprint under the vessel. Because they do not fully ensonify the seafloor, it is possible - and even probable - that features will remain undetected between survey lines. To mitigate this, modern hydrographic surveyors often use singlebeam echosounders in tandem with Side Scan Sonar, a towed sensor that creates a photorealistic sonar image of a wide swath of seafloor on either side of the survey vessel. Side scan sonar records can be used for feature identification, but provide only limited depth information. If the two sensors are used in tandem, the hydrographer obtains tracklines of depth information, with sonar images between them. Any hazardous features that are identified in the sidescan record can then be further investigated and developed with the echosounder to obtain a least depth for charting.

307. Multibeam Echosounders

Multibeam echosounders operate on similar principles to singlebeam echosounders, except that they send out many individual sonar pings, at a rate of many pulses per second, in a wide swath on either side of the vessel. This rapid and dense ensonification of the seafloor can produce a very high-resolution three dimensional reproduction of the surface of the seafloor. These data can be made even more accurate by the application of corrections for changes in sound velocity due to water depth, temperature and salinity, and by applying compensation for vessel motion. Precise horizontal positioning from GPS and vertical corrections for tidal variations in coastal waters can also be applied to the data, either in real-time or during data processing. The width of the multibeam sonar swath, and the resolution of the data it collects varies based on the frequency of the sonar and the water depth (see Figure 307). In general, high-frequency, high-resolution sonars are better suited to coastal waters, while lower-frequency, lower-resolution sonars have an extended range that can map the deepest ocean depths. Multibeam sonar may be installed permanently on a vessel, deployed on an ROV, AUV or towed sensor, or may be temporarily operated from a small craft.

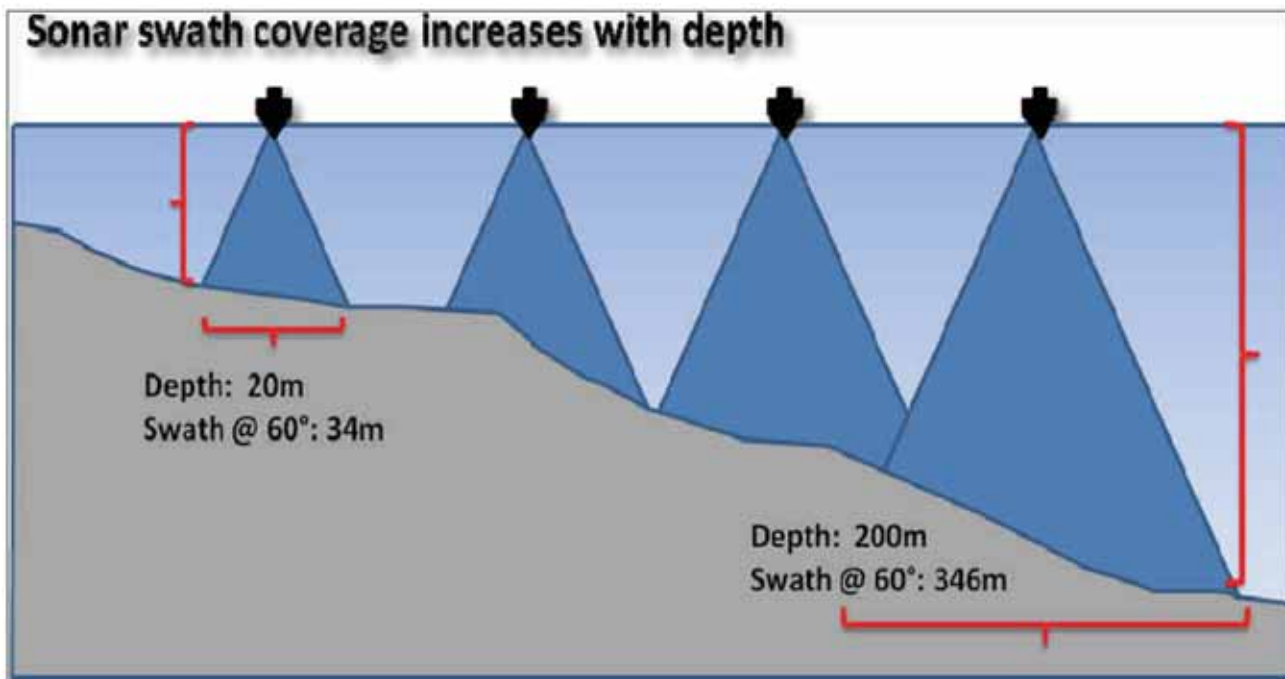

Figure 307. Comparison of sonar swath coverage at different water depths.

308. Bathymetric LIDAR

Airborne Laser Hydrography (ALH), or Bathymetric Light Detection and Ranging (LIDAR), uses laser transmitters to conduct hydrographic surveys from aircraft.

It is useful in areas of complex hydrography where rocks, shoals and obstructions pose a danger to traditional survey vessels, and under ideal conditions it can create a high-resolution map of the seafloor (see Figure 308).

Bathymetric LIDAR sensors are mounted on the

bottom of an aircraft and usually transmit lasers in two bands of the electromagnetic spectrum: a green laser that penetrates the water column and collects depth measurements, and an infrared laser for sea surface detection. The difference in time between the transmittal of the green laser to its reflected reception is a function of the water depth. These data are correlated with position data obtained from GPS and adjusted for tides and atmospheric conditions.

As with all survey techniques, LIDAR has some limitations. Water penetration is limited by the strength of the laser signal and the clarity of the water. Under ideal

conditions, depth measurements have been collected in up to 60 meters of water depth, but in most cases the laser extinction depth is closer to 20m. Feature detection is limited by the footprint of the laser beam when it enters the water, so, as with SONAR, in some cases features may be missed. Very smooth sea surface conditions can prevent data collection because the surface becomes mirror-like, reflecting pulses off the surface instead of penetrating the water column. Conversely, patches of surf, or very rough water, can cause the laser pulse to scatter. Kelp or dense vegetation can also prevent data collection using this method.

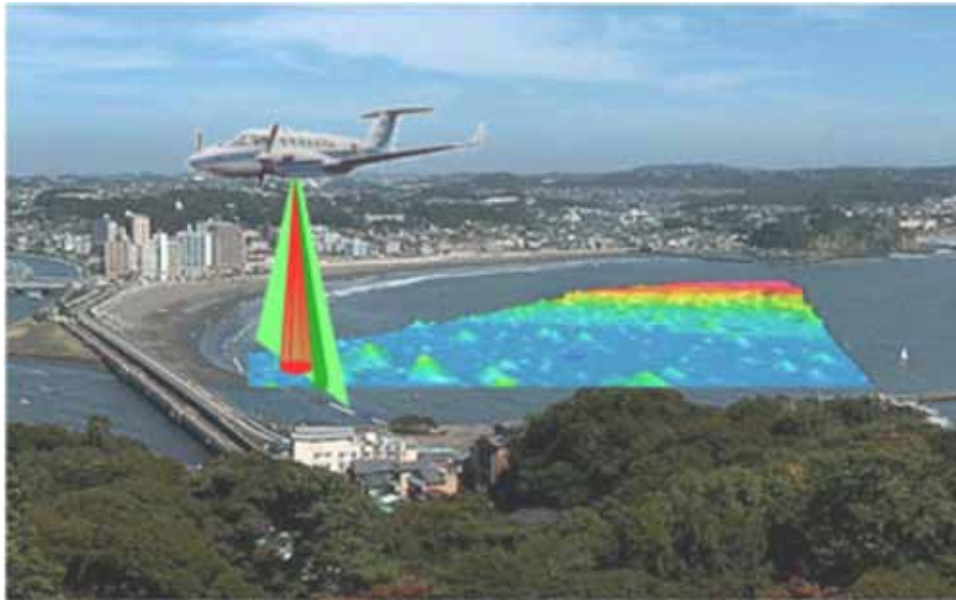

Figure 308. Collecting bathymetric LIDAR data. Image courtesy of NOAA.

PROCESSING HYDROGRAPHIC DATA

309. Introduction

In the past, sounding selection and survey data compilation required creating hardcopy plots of depth information and conducting extensive manual review. Today, hydrographers and bathymetrists use dedicated survey data processing software to model data in *three dimensions*, identify errors in the data, apply corrections and create finished products. Hydrographic offices keep databases of survey data, which are incorporated into nautical charts. Survey data is thoroughly evaluated to determine the degree of accuracy or uncertainty in measurements, the level of confidence in the data, and the area of seafloor coverage. This data quality information can then be relayed to the mariner through a source diagram, chart note, **Zone of Confidence (ZOC) diagram**, or as a layer in digital charts. As previously noted, the degree of seafloor coverage varies widely, based on the technology available and the type of survey technique used (see Figure 309).

310. Zones of Confidence

Category Zones of Confidence (CATZOC) were developed through the efforts of member nations within the International Hydrographic Organization, and they provide information about the quality and coverage of cartographic data in an area. The four criteria based for making assessments include position accuracy, depth accuracy, seafloor coverage and survey characteristics.

There are currently six CATZOC types, ranging from full seafloor coverage with significant feature detection to poor, or unassessed categories. If a nautical chart includes a ZOC diagram or if an ENC has a CATZOC layer, it can help the mariner make informed navigation decisions by highlighting areas that have denser bathymetric data coverage, as well as areas where information may be thinner or of uncertain quality.

In areas of uncertain data quality, mariners should proceed with an extra level of caution. Source diagrams and

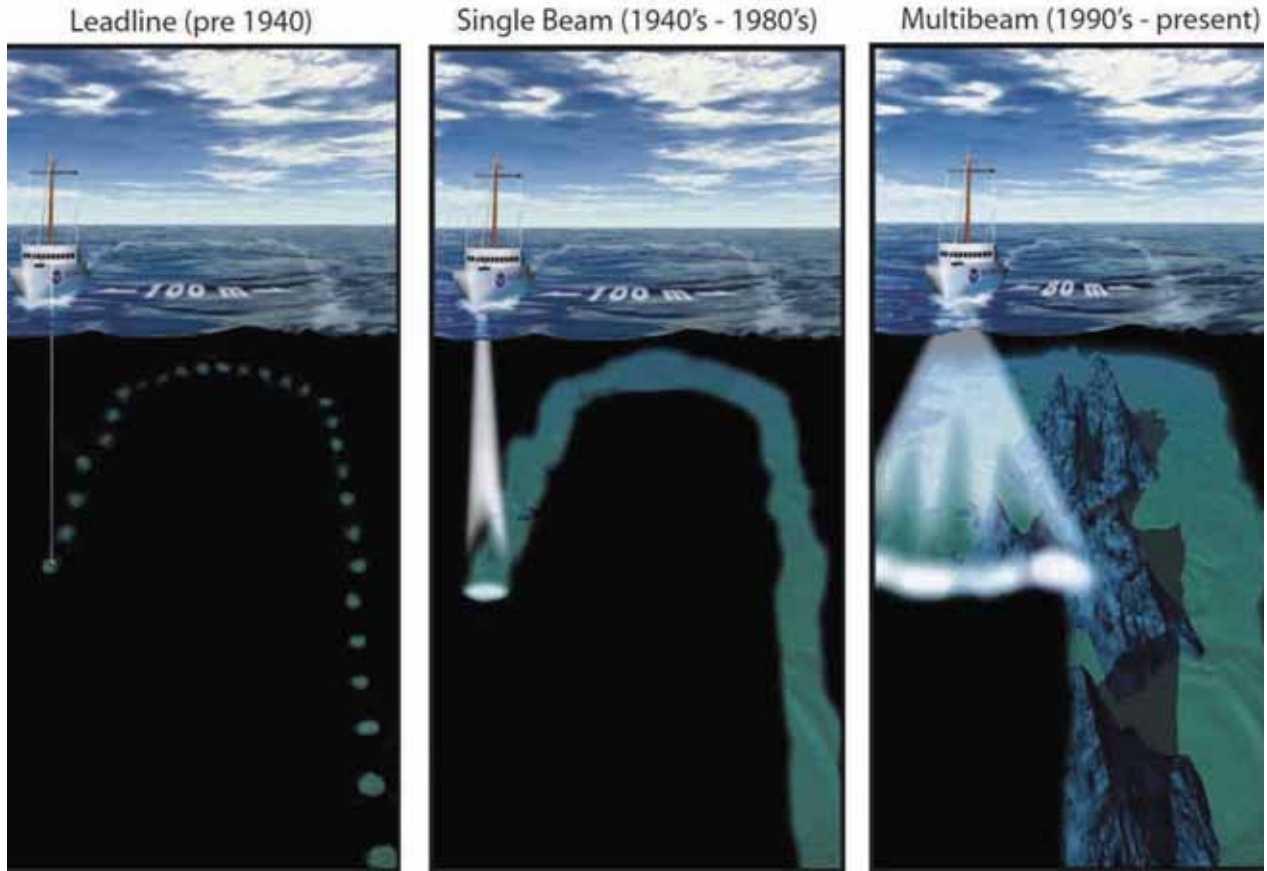

Figure 309. Differences in coverage between hydrographic techniques. Image courtesy of NOAA.

zones of confidence are discussed in greater detail in the next chapter (see Section 428).

OTHER SOURCES OF BATHYMETRIC DATA

311. Limited Resources Drive Survey Priorities

Hydrographic surveys are expensive and time-consuming to conduct, and even after hundreds of years of seafloor mapping, the vast majority of the Earth's oceans remain a mystery. The extent of the seafloor is simply too vast, and current resources are too limited, to fully image every meter of submerged real estate. For that reason, most high-resolution, dedicated hydrographic surveys are conducted in coastal areas, where dangers to surface navigation is the greatest. In deeper water, scientific surveys, oil and gas exploration, and other surveys of opportunity have also yielded some data. However, even in open ocean areas dangers to navigation exist. Newly forming submerged volcanoes or uncharted seamounts have caused maritime accidents in the past. To mitigate these uncharted hazards, hydrographers have sought alternative methods of data collection, to supplement what is already known.

312. Satellite Altimetry

In some areas of the open ocean there are vertical variations in the sea surface that can provide hydrographers and geodesists with critical information about seafloor features. The presence of massive seamounts or submarine canyons deflects the directional pull of gravity from the vertical, which creates a corresponding bulge or depression of water on the sea surface (see Figure 312). These anomalies can be detected with satellite-mounted radar altimeters. The altimeter sends a radar pulse through the atmosphere to the ocean surface, and the amount of time it takes for the reflected pulse to return to the altimeter provides a measurement of variations in sea surface. These sea surface measurements are translated into a quantification of the “deflection of the vertical” pull of gravity, which in turn is used to create a model of the geoid, or approximate surface of the Earth. For several decades, hydrographers have used these altimetry-derived geoid models to identify large seafloor ridges, seamounts and canyons.

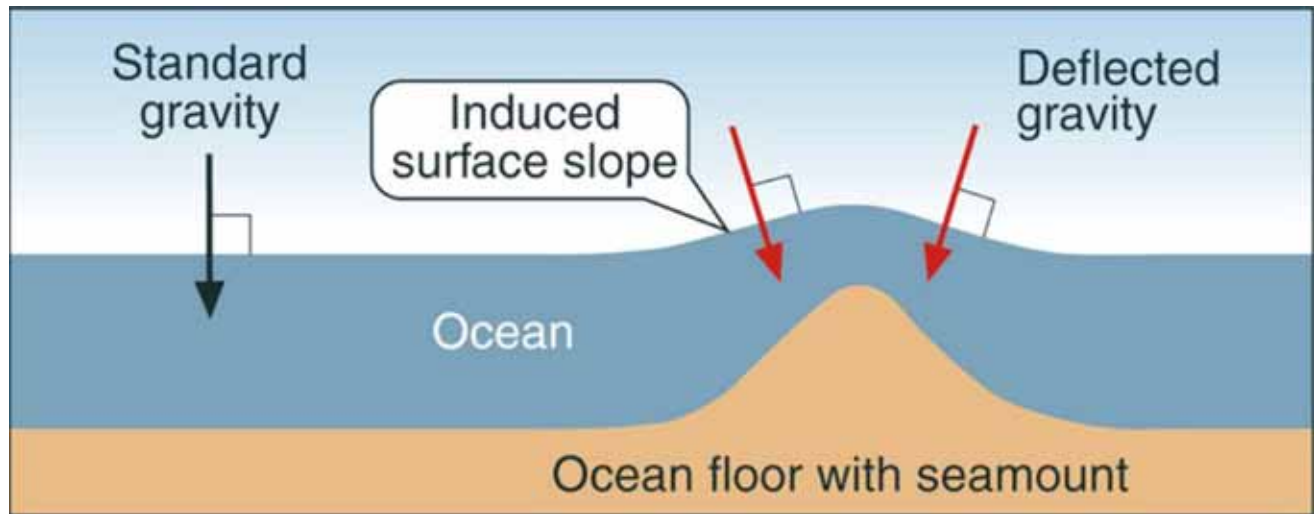

Figure 312. A rise in the ocean surface caused by a large seamount. Image courtesy of NOAA.

313. Marine Gravity

Early shipboard marine gravity measurements were collected in the late 1920s by submariners using pendulum-based apparatus to measure changes in gravitational pull that might indicate a submerged feature. In the 1950's, mariners began collecting gravity measurements from surface vessels as well. Although the technology behind these sensors vary from primitive to highly advanced, they all operate under the basic principle that local variations in gravity can provide information about seafloor features such as seamounts and ridges.

314. Satellite Imagery Derived Bathymetry

Recently, hydrographers have begun exploring the use of satellite-mounted, multispectral optical sensors for deriving remotely detected bathymetry estimates. Satellite sensors have the ability to rapidly image a large area of the seafloor at relatively low cost, which gives them a distinct advantage over traditional survey techniques. Using sunlight as a natural source of illumination, these optical sensors passively measure the wavelength of light that is reflected off the seafloor and back to the sensor. By applying algorithms to the data, relative seafloor depth estimates can be obtained. This technology has been explored by both commercial interests and international hydrographic offices, and although this technology is still developing, it holds promising potential for tracking migrating shoals, identifying uncharted features, and evaluating the need for updated nautical charts in an area. However, the quality of depth measurements are

constrained by water depth, bottom type, water clarity and atmospheric conditions. In addition, more research is needed to determine the limitations of different algorithms, and the level of uncertainty in the measurements.

315. Crowd Sourced Bathymetry

For hundreds of years, mariners have contributed information to nautical charts by providing eyewitness reports, depth measurements, chart discrepancies and other information to charting offices. To this day, ship reports from mariners continue to provide hydrographic offices with vital information on emerging hazards, uncharted obstacles and depth discrepancies. This symbiosis between mariner and cartographer is essentially a form of crowd-sourcing nautical information. Crowd-sourced bathymetry is recent initiative that follows in the footsteps of traditional ship reports, but takes it a step further by encouraging mariners to log data directly from their echosounders while underway, and to contribute these data to a publicly available central data repository.

An international group of hydrographers, working under the auspices of the International Hydrographic Organization (IHO), are currently creating a central repository for mariner-contributed data and developing a guidance document for mariners willing to voluntarily collect and contribute their data. It is hoped that this crowd-sourced data could be a key provider of information that will contribute to a better understanding of the seafloor. Mariners interested in participating in this effort can find more information at the International Hydrographic Organization's website.

LOOKING FORWARD

316. New Technology and Approaches

History has taught us to expect that the future will bring many changes and advances in hydrographic survey techniques and technology. If the current trend holds true, surveys of the future will be conducted faster, more accurately, and at a lower cost than in the past, and sensors will become more capable. **Autonomous platforms**, remote sensing, and other technologies are already in play in the world of hydrography, and this technology can only improve. Hydrographers are considering new approaches to data quality analysis, and are seeking better ways to improve global data sharing, leading to the development of a high-resolution global bathymetric surface and improve

existing interpolated models. Surveys of the future could be referenced to the ellipsoid, instead of local chart datums, enabling bathymetric surfaces to be vertically linked together in a manner that is currently difficult or impossible on a global scale. Perhaps one day navigation surfaces will be incorporated directly into electronic charting software, allowing the mariner to see seafloor relief directly.

Such advances will benefit the mariner, and the prudent mariner should stay informed of developments in the world of nautical charting and hydrographic surveying. As technology marches on, hydrographic offices will adapt, and will continue to strive to provide the mariner with the most up-to-date information on data quality and data sources in support of safe navigation.

CHAPTER 4

NAUTICAL CHARTS

CHART FUNDAMENTALS

400. Definitions

A **nautical chart** represents part of the spherical earth on a plane surface. It shows water depth, the shoreline of adjacent land, prominent topographic features, aids to navigation, and other navigational information. It is a work area on which the navigator plots courses, ascertains positions, and views the relationship of the ship to the surrounding area. It assists navigators in avoiding dangers and arriving safely at their destination.

Should a marine accident occur, the nautical chart in use at the time takes on legal significance. In cases of grounding, collision, and other accidents, charts become critical records for reconstructing the event and assigning liability. Charts used in reconstructing the incident can also have tremendous training value.

Originally hand-drawn on sheepskin, traditional nautical charts have for generations been printed on paper. **Electronic Charts** consisting of a digital data base and a display system are commonly in use today and are replacing paper charts aboard many vessels. An electronic chart is not simply a digital version of a paper chart; it introduces a new navigation methodology with capabilities and limitations very different from paper charts. The electronic chart is the legal equivalent of the paper chart if it meets certain International Maritime Organization specifications. See Chapter 5 - ECDIS for a detailed information regarding electronic charts.

401. Projections

Because a cartographer cannot transfer a sphere to a flat surface without distortion, he or she must project the surface of a sphere onto a **developable surface**. A developable surface is one that can be flattened to form a plane. This process is known as **chart projection**. If points on the surface of a sphere are projected from a single point, the projection is said to be **perspective** or **geometric**.

As the use of electronic charts becomes increasingly widespread, it is important to remember that the same cartographic principles that apply to paper charts apply to their depiction on video screens.

402. Selecting a Projection

Each projection has certain preferable features. However, as the area covered by the chart becomes smaller, the differences between various projections become less noticeable. On the largest scale chart, such as that of a harbor, projections are practically identical. Some desirable properties of a projection are:

1. True shape of physical features
2. Correct angular relationships
3. Equal area (Represents areas in proper proportions)
4. Constant scale values
5. Great circles represented as straight lines
6. Rhumb lines represented as straight lines

Some of these properties are mutually exclusive. For example, a single projection cannot be both conformal and equal area. Similarly, both great circles and rhumb lines cannot be represented on a single projection as straight lines.

403. Types of Projections

The type of developable surface to which the spherical surface is transferred determines the projection's classification. Further classification depends on whether the projection is centered on the equator (equatorial), a pole (polar), or some point or line between (oblique). The name of a projection indicates its type and its principal features.

The **Mercator projection** is classified as a **cylindrical projection** upon a plane, the cylinder tangent along the equator. Similarly, a projection based upon a cylinder tangent along a meridian is called **transverse** (or inverse) **Mercator** or **transverse** (or inverse) **orthomorphic**. The Mercator is the most common projection used in maritime navigation, primarily because rhumb lines plot as straight lines.

In a **simple conic projection**, points on the surface of the earth are transferred to a tangent cone. In the **Lambert conformal projection**, the cone intersects the earth (a secant cone) at two small circles. In a **polyconic projection**, a series of tangent cones is used.

In an **azimuthal** or **zenithal projection**, points on the earth are transferred directly to a plane. If the origin of the projecting rays is the center of the earth, a **gnomonic pro-**

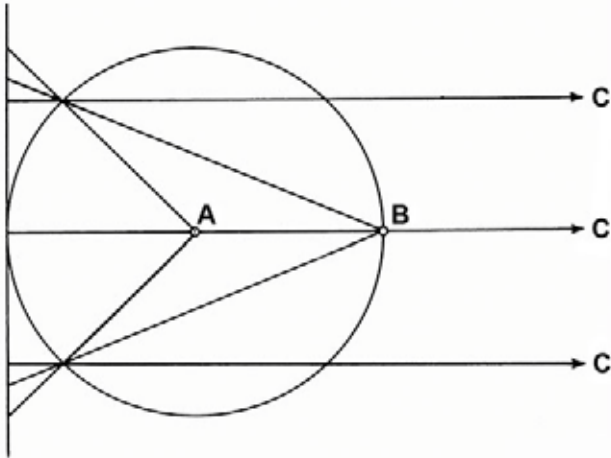

Figure 403. Azimuthal projections: A, gnomonic; B, stereographic; C, (at infinity) orthographic.

jection results; if it is the point opposite the plane's point of tangency, a **stereographic projection**; and if at infinity (the projecting lines being parallel to each other), an **orthographic projection**. The gnomonic, stereographic, and orthographic are **perspective projections**. In an **azimuthal equidistant projection**, which is not perspective, the scale of distances is constant along any radial line from the point of tangency. See Figure 403.

Cylindrical and plane projections are special conical projections, using heights infinity and zero, respectively.

A **graticule** is the network of latitude and longitude lines laid out in accordance with the principles of any projection.

404. Cylindrical Projections

If a cylinder is placed around the earth, tangent along the equator, and the planes of the meridians are extended, they intersect the cylinder in a number of vertical lines. See Figure 404. These parallel lines of projection are equidistant from each other, unlike the terrestrial meridians from which they are derived which converge as the latitude increases. On the earth, parallels of latitude are perpendicular to the meridians, forming circles of progressively smaller diameter as the latitude increases. On the cylinder they are shown perpendicular to the projected meridians, but because a cylinder is everywhere of the same diameter, the projected parallels are all the same size.

If the cylinder is cut along a vertical line (a meridian) and spread out flat, the meridians appear as equally spaced vertical lines; and the parallels appear as horizontal lines. The parallels' relative spacing differs in the various types of cylindrical projections.

If the cylinder is tangent along some great circle other than the equator, the projected pattern of latitude and longitude lines appears quite different from that described above, since the line of tangency and the equator no longer coin-

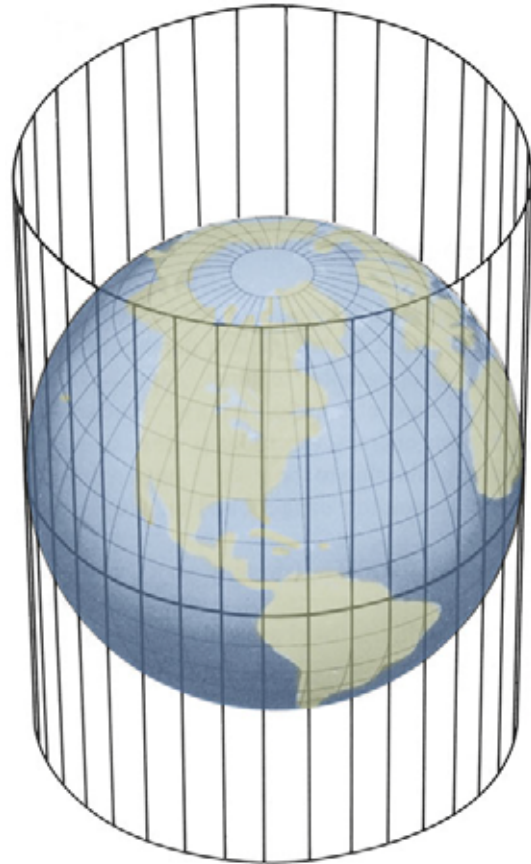

Figure 404. A cylindrical projection.

cide. These projections are classified as **oblique** or **transverse projections**.

405. Mercator Projection

Navigators most often use the plane conformal projection known as the **Mercator projection**. The Mercator projection is not perspective, and its parallels can be derived mathematically as well as projected geometrically. Its distinguishing feature is that both the meridians and parallels are expanded at the same ratio with increased latitude. The expansion is equal to the secant of the latitude, with a small correction for the ellipticity of the earth. Since the secant of 90° is infinity, the projection cannot include the poles. Since the projection is conformal, expansion is the same in all directions and angles are correctly shown. Rhumb lines appear as straight lines, the directions of which can be measured directly on the chart. Distances can also be measured directly if the spread of latitude is small. Great circles, except meridians and the equator, appear as curved lines concave to the equator. Small areas appear in their correct shape but of increased size unless they are near the equator.

406. Meridional Parts

At the equator a degree of longitude is approximately

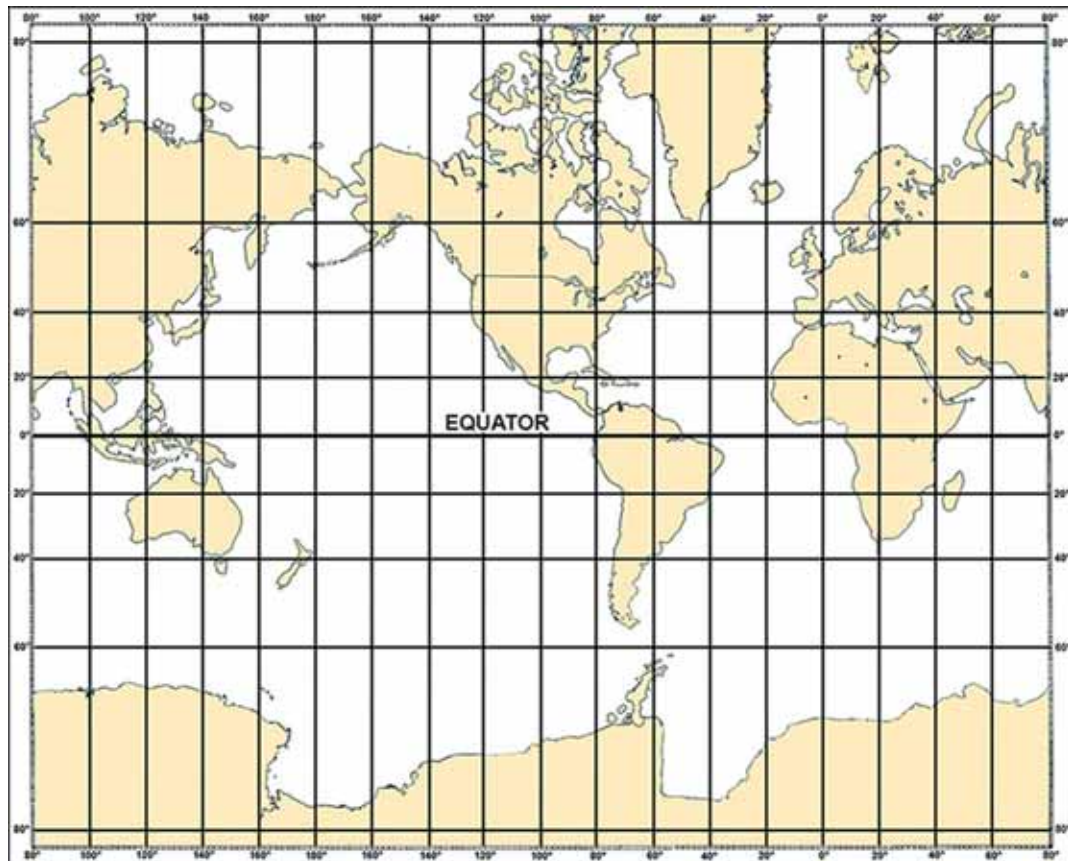

Figure 405. A Mercator map of the world.

equal in length to a degree of latitude. As the distance from the equator increases, degrees of latitude remain approximately the same, while degrees of longitude become progressively shorter. Since degrees of longitude appear everywhere the same length in the Mercator projection, it is necessary to increase the length of the meridians if the expansion is to be equal in all directions. Thus, to maintain the correct proportions between degrees of latitude and degrees of longitude, the degrees of latitude must be progressively longer as the distance from the equator increases. This is illustrated in Figure 405.

The length of a meridian, increased between the equator and any given latitude, expressed in minutes of arc at the equator as a unit, constitutes the number of meridional parts (M) corresponding to that latitude. Meridional parts, given in Table 6 for every minute of latitude from the equator to the pole, make it possible to construct a Mercator chart and to solve problems in Mercator sailing. These values are for the World Geodetic System (WGS) ellipsoid of 1984.

407. Transverse Mercator Projections

Constructing a chart using Mercator principles, but with the cylinder tangent along a meridian, results in a **transverse Mercator** or **transverse orthomorphic projection**. The word “inverse” is used interchangeably with

“transverse.” These projections use a fictitious graticule similar to, but offset from, the familiar network of meridians and parallels. The tangent great circle is the fictitious equator. Ninety degrees from it are two fictitious poles. A group of great circles through these poles and perpendicular to the tangent great circle are the fictitious meridians, while a series of circles parallel to the plane of the tangent great circle form the fictitious parallels. The actual meridians and parallels appear as curved lines.

A straight line on the transverse or oblique Mercator projection makes the same angle with all fictitious meridians, but not with the terrestrial meridians. It is therefore a fictitious rhumb line. Near the tangent great circle, a straight line closely approximates a great circle. The projection is most useful in this area. Since the area of minimum distortion is near a meridian, this projection is useful for charts covering a large band of latitude and extending a relatively short distance on each side of the tangent meridian. It is sometimes used for star charts showing the evening sky at various seasons of the year. See Figure 407.

408. Universal Transverse Mercator (UTM) Grid

The **Universal Transverse Mercator (UTM)** grid is a military grid superimposed upon a transverse Mercator grati-

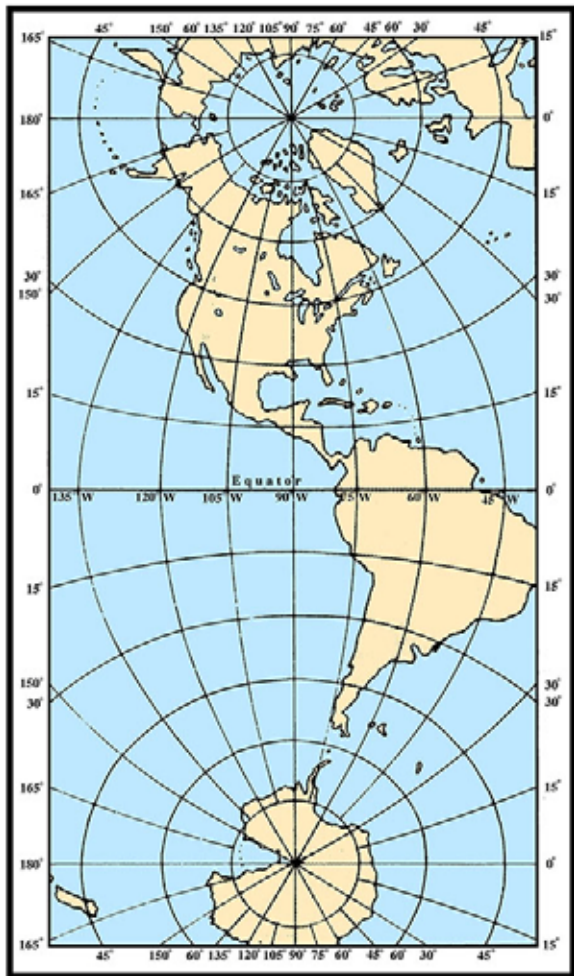

Figure 407. A transverse Mercator map of the Western Hemisphere.

cule, or the representation of these grid lines upon any graticule. This grid system and these projections are often used for large-scale (harbor) nautical charts and military charts.

409. Oblique Mercator Projections

A Mercator projection in which the cylinder is tangent along a great circle other than the equator or a meridian is called an **oblique Mercator** or **oblique orthomorphic projection**. See Figure 409a and Figure 409b. This projection is used principally to depict an area in the near vicinity of an oblique great circle. Figure 410, for example, shows the great circle joining Washington and Moscow. Figure 409c shows an oblique Mercator map with the great circle between these two centers as the tangent great circle or fictitious equator. The limits of the chart of Figure 410 are indicated in Figure 409c. Note the large variation in scale as the latitude changes.

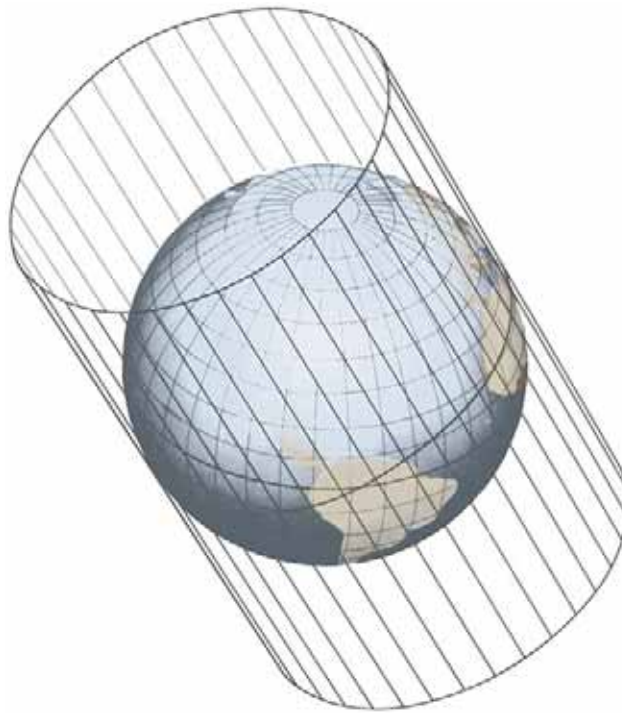

Figure 409a. An oblique Mercator projection.

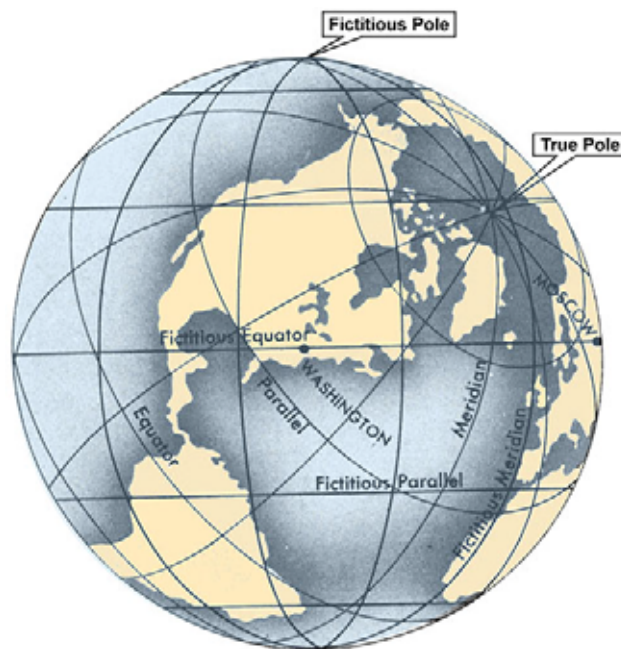

Figure 409b. An oblique Orthomorphic projection.

410. Rectangular Projection

A cylindrical projection similar to the Mercator, but with uniform spacing of the parallels, is called a **rectangular projection**. It is convenient for graphically depicting information where distortion is not important. The principal



Figure 409c. An oblique Mercator map based upon a cylinder tangent along the great circle through Washington and Moscow. The map includes an area 500 miles on each side of the great circle. The limits of this map are indicated on the Mercator map of Figure 410.

navigation use of this projection is for the star chart of the Air Almanac, where positions of stars are plotted by rectangular coordinates representing declination (ordinate) and

sidereal hour angle (abscissa). Since the meridians are parallel, the parallels of latitude (including the equator and the poles) are all represented by lines of equal length.



Figure 410. The great circle between Washington and Moscow as it appears on a Mercator map.

411. Conic Projections

A **conic projection** is produced by transferring points from the surface of the earth to a cone or series of cones. This cone is then cut along an element and spread out flat to form the chart. When the axis of the cone coincides with the axis of the earth, then the parallels appear as arcs of circles, and the meridians appear as either straight or curved lines converging toward the nearer pole. Limiting the area covered to that part of the cone near the surface of the earth limits distortion. A parallel along which there is no distortion is called a **standard parallel**. Neither the transverse conic projection, in which the axis of the cone is in the equatorial plane, nor the oblique conic projection, in which the axis of the cone is oblique to the plane of the equator, is ordinarily used for navigation. They are typically used for

illustrative maps.

Using cones tangent at various parallels, a secant (intersecting) cone, or a series of cones varies the appearance and features of a conic projection.

412. Simple Conic Projection

A conic projection using a single tangent cone is a **simple conic projection** (Figure 412a). The height of the cone increases as the latitude of the tangent parallel decreases. At the equator, the height reaches infinity and the cone becomes a cylinder. At the pole, its height is zero, and the cone becomes a plane. Similar to the Mercator projection, the simple conic projection is not perspective since only the meridians are projected geometrically, each becoming an element of the cone. When this projection is spread out flat

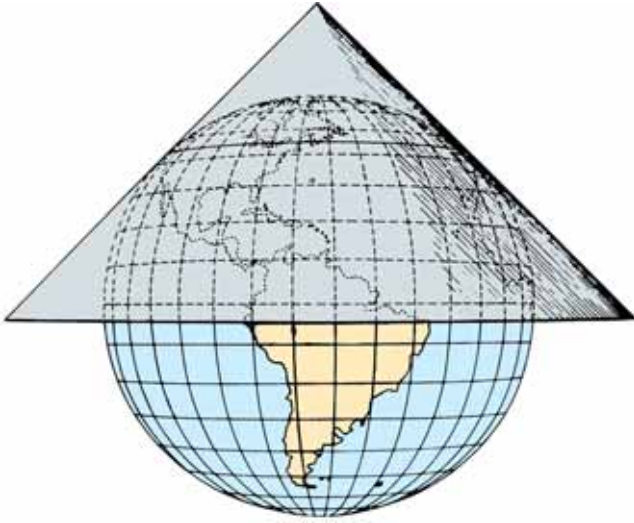

Figure 412a. A simple conic projection.

to form a map, the meridians appear as straight lines converging at the apex of the cone. The standard parallel,

where the cone is tangent to the earth, appears as the arc of a circle with its center at the apex of the cone. The other parallels are concentric circles. The distance along any meridian between consecutive parallels is in correct relation to the distance on the earth, and, therefore, can be derived mathematically. The pole is represented by a circle (Figure 412b). The scale is correct along any meridian and along the standard parallel. All other parallels are too great in length, with the error increasing with increased distance from the standard parallel. Since the scale is not the same in all directions about every point, the projection is neither a conformal nor equal-area projection. Its non-conformal nature is its principal disadvantage for navigation.

Since the scale is correct along the standard parallel and varies uniformly on each side, with comparatively little distortion near the standard parallel, this projection is useful for mapping an area covering a large spread of longitude and a comparatively narrow band of latitude. It was developed by Claudius Ptolemy in the second century A.D. to map just such an area: the Mediterranean Sea.

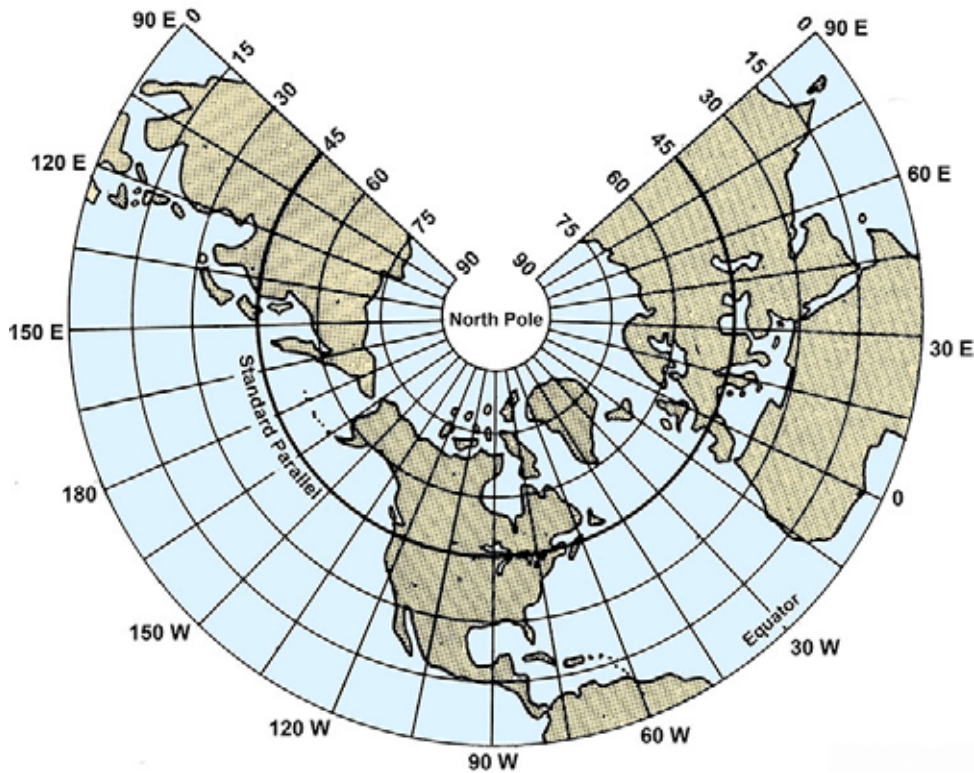

Figure 412b. A simple conic map of the Northern Hemisphere.

413. Lambert Conformal Projection

The useful latitude range of the simple conic projection can be increased by using a secant cone intersecting the earth at two standard parallels (see Figure 413). The area between the two standard parallels is compressed, and that beyond is

expanded. Such a projection is called either a **secant conic** or **conic projection with two standard parallels**.

If in such a projection the spacing of the parallels is altered, such that the distortion is the same along them as along the meridians, the projection becomes conformal. This modification produces the **Lambert conformal pro-**

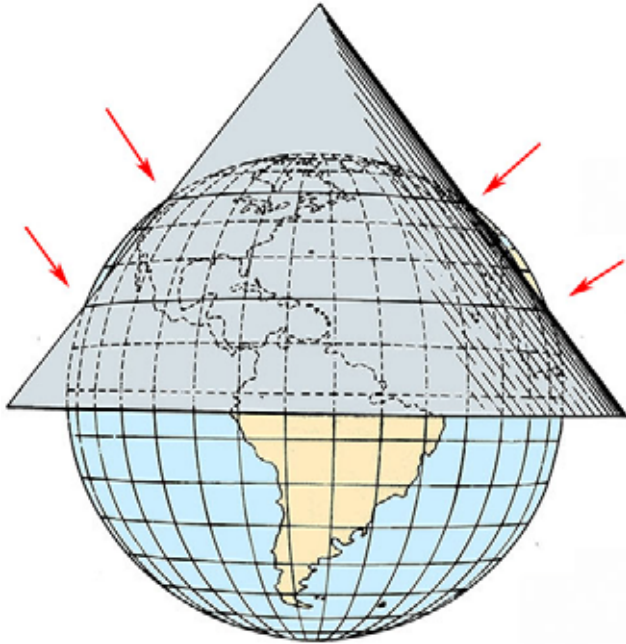

Figure 413. A secant cone for a conic projection with two standard parallels.

jection. If the chart is not carried far beyond the standard parallels, and if these are not a great distance apart, the distortion over the entire chart is small.

A straight line on this projection so nearly approximates a great circle that the two are nearly identical. Radio beacon signals travel great circles; thus, they can be plotted on this projection without correction. This feature, gained without sacrificing conformality, has made this projection popular for aeronautical charts because aircraft make wide use of radio aids to navigation. Except in high latitudes, where a slightly modified form of this projection has been used for polar charts, it has not replaced the Mercator projection for marine navigation.

414. Polyconic Projection

The latitude limitations of the secant conic projection can be minimized by using a series of cones. This results in a **polyconic projection**. In this projection, each parallel is the base of a tangent cone. At the edges of the chart, the area between parallels is expanded to eliminate gaps. The scale is correct along any parallel and along the central meridian of the projection. Along other meridians the scale increases with increased difference of longitude from the central meridian. Parallels appear as nonconcentric circles, meridians appear as curved lines converging toward the pole and concave to the central meridian.

The polyconic projection is widely used in atlases, particularly for areas of large range in latitude and reasonably large range in longitude, such as continents. However, since it is not conformal, this projection is not traditionally used in navigation.

415. Azimuthal Projections

If points on the earth are projected directly to a plane surface, a map is formed at once, without cutting and flattening, or “developing.” This can be considered a special case of a conic projection in which the cone has zero height.

The simplest case of the **azimuthal projection** is one in which the plane is tangent at one of the poles. The meridians are straight lines intersecting at the pole, and the parallels are concentric circles with their common center at the pole. Their spacing depends upon the method used to transfer points from the earth to the plane.

If the plane is tangent at some point other than a pole, straight lines through the point of tangency are great circles, and concentric circles with their common center at the point of tangency connect points of equal distance from that point. Distortion, which is zero at the point of tangency, increases along any great circle through this point. Along any circle whose center is the point of tangency, the distortion is constant. The bearing of any point from the point of tangency is correctly represented. It is for this reason that these projections are called **azimuthal**. They are also called **zenithal**. Several of the common azimuthal projections are perspective.

416. Gnomonic Projection

If a plane is tangent to the earth, and points are projected geometrically from the center of the earth, the result is a **gnomonic projection** (see Figure 416a). Since the projec-

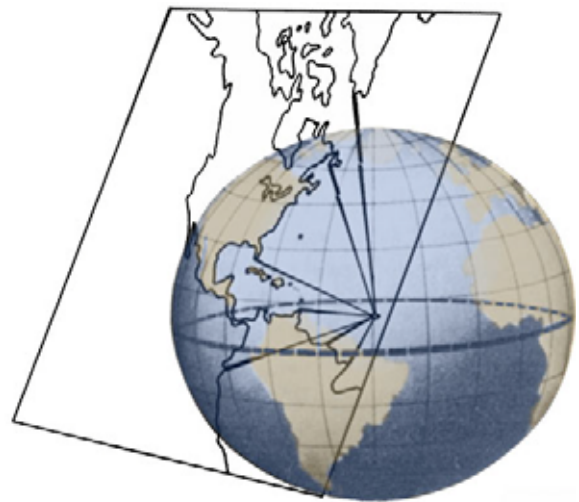

Figure 416a. An oblique gnomonic projection.

tion is perspective, it can be demonstrated by placing a light at the center of a transparent terrestrial globe and holding a flat surface tangent to the sphere.

In an **oblique gnomonic projection** the meridians appear as straight lines converging toward the nearer pole. The parallels, except the equator, appear as curves (Figure 416b).

As in all azimuthal projections, bearings from the point of tangency are correctly represented. The distance scale, however, changes rapidly. The projection is neither conformal nor equal area. Distortion is so great that shapes, as well as distances and areas, are very poorly represented, except near the point of tangency.

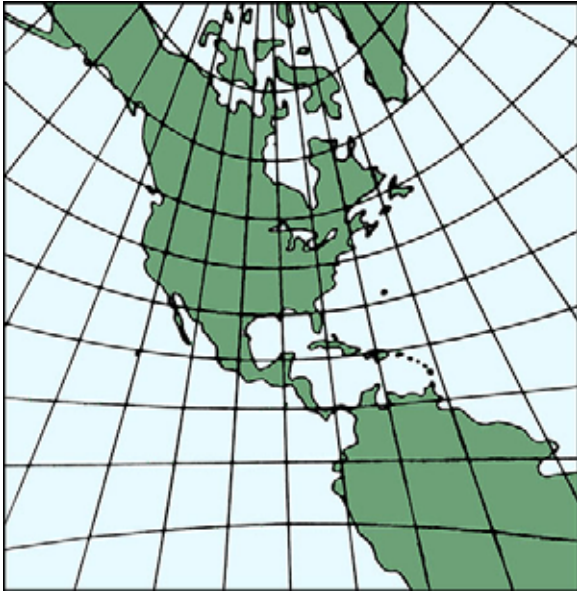

Figure 416b. An oblique gnomonic map with point of tangency at latitude 30°N, longitude 90°W.

The usefulness of this projection rests upon the fact that any great circle appears on the map as a straight line, giving charts made on this projection the common name **great-circle charts**.

Gnomonic charts are most often used for planning the great-circle track between points. Points along the determined track are then transferred to a Mercator projection. The great circle is then tracked by following the rhumb lines from one point to the next. Computer programs which automatically calculate great circle routes between points and provide latitude and longitude of corresponding rhumb line endpoints are quickly making this use of the gnomonic chart obsolete.

417. Stereographic Projection

A **stereographic projection** results from projecting points on the surface of the earth onto a tangent plane, from a point on the surface of the earth opposite the point of tangency (see Figure 417a). This projection is also called an **azimuthal orthomorphic projection**.

The scale of the stereographic projection increases with distance from the point of tangency, but it increases more slowly than in the gnomonic projection. The stereographic projection can show an entire hemisphere without excessive distortion (see Figure 417b). As in other azimuthal

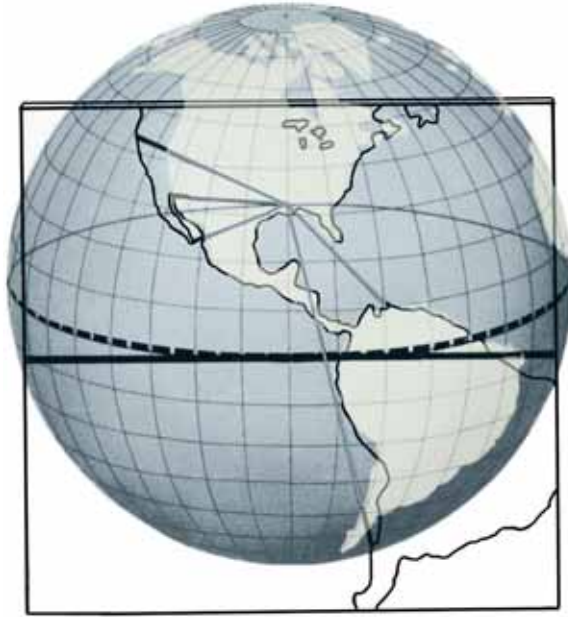

Figure 417a. An equatorial stereographic projection.

al projections, great circles through the point of tangency appear as straight lines. Other circles such as meridians and parallels appear as either circles or arcs of circles.

The principal navigational use of the stereographic projection is for charts of the polar regions and devices for mechanical or graphical solution of the navigational triangle. A **Universal Polar Stereographic (UPS)** grid, mathematically adjusted to the graticule, is used as a reference system.

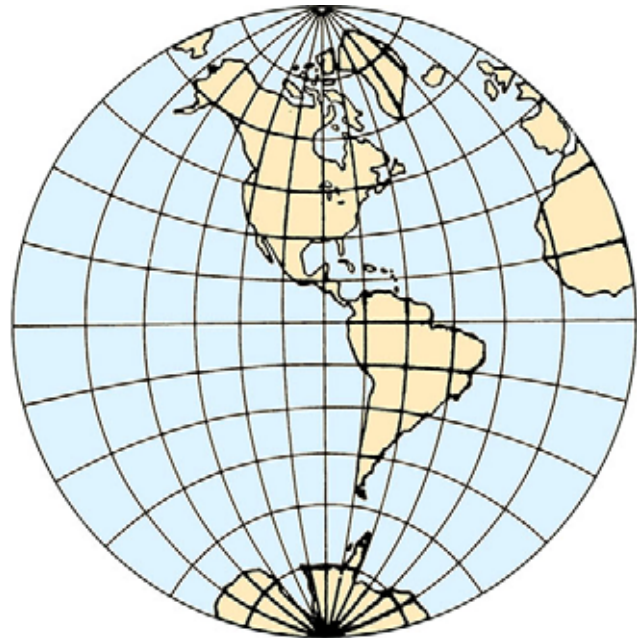

Figure 417b. A stereographic map of the Western Hemisphere.

418. Orthographic Projection

If terrestrial points are projected geometrically from in-

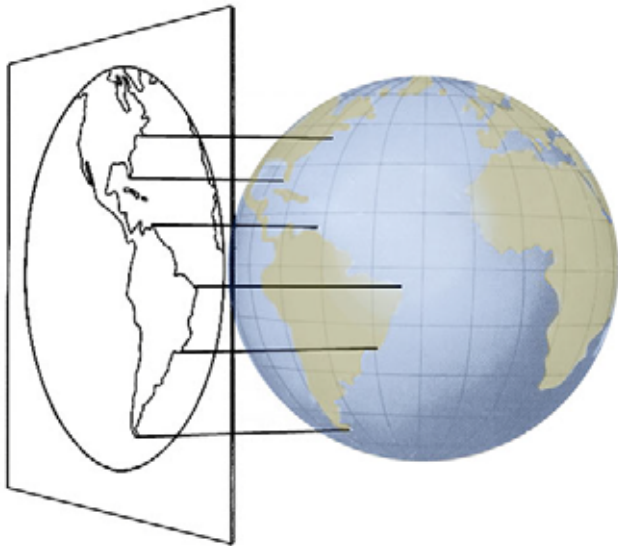

Figure 418a. An equatorial orthographic projection.



Figure 418b. An orthographic map of the Western Hemisphere.

finity to a tangent plane, an **orthographic projection** results (see Figure 418a). This projection is not conformal, nor does it result in an equal area representation. Its principal use is in navigational astronomy because it is useful for illustrating and solving the navigational triangle. It is also useful for illustrating celestial coordinates. If the plane is tangent at a point on the equator, the parallels (including the

equator) appear as straight lines. The meridians would appear as ellipses, except that the meridian through the point of tangency would appear as a straight line and the one 90° away would appear as a circle (see Figure 418b).

419. Azimuthal Equidistant Projection

An **azimuthal equidistant projection** is an azimuthal projection in which the distance scale along any great circle through the point of tangency is constant. If a pole is the point of tangency, the meridians appear as straight radial lines and the parallels as equally spaced concentric circles. If the plane is tangent at some point other than a pole, the concentric circles represent distances from the point of tangency. In this case, meridians and parallels appear as curves.

The projection can be used to portray the entire earth, the point 180° from the point of tangency appearing as the largest of the concentric circles. The projection is not conformal, equal area, or perspective. Near the point of tangency distortion is small, increasing with distance until shapes near the opposite side of the earth are unrecognizable (Figure 419).

The projection is useful because it combines the three

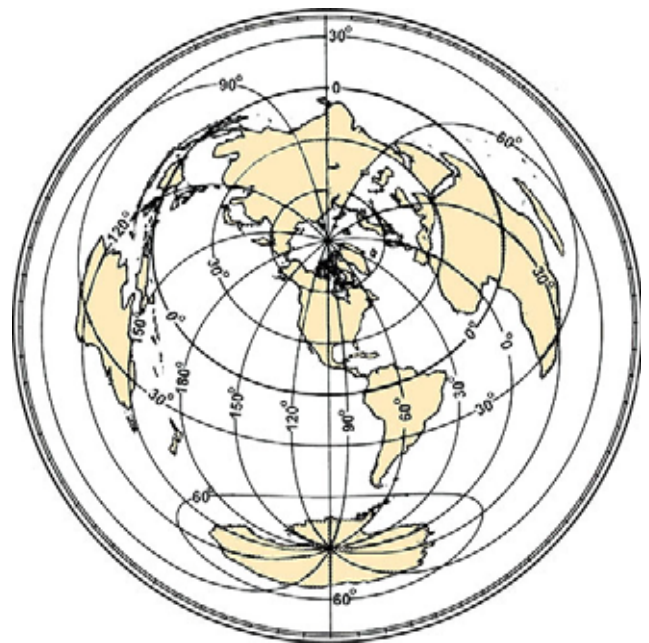

Figure 419. An azimuthal equidistant map of the world with the point of tangency latitude 40°N , longitude 100°W .

features of being azimuthal, having a constant distance scale from the point of tangency, and permitting the entire earth to be shown on one map. Thus, if an important harbor or airport is selected as the point of tangency, the great-circle course, distance, and track from that point to any other point on the earth are quickly and accurately determined. For communication work with the station at the point of tangency, the path of an incoming signal is at once apparent if the direction of arrival has been determined and

the direction to train a directional antenna can be determined easily. The projection is also used for polar

charts and for the star finder, No. 2102D.

POLAR CHARTS

420. Polar Projections

Special consideration is given to the selection of projections for polar charts because the familiar projections become special cases with unique features.

In the case of cylindrical projections in which the axis of the cylinder is parallel to the polar axis of the earth, distortion becomes excessive and the scale changes rapidly. Such projections cannot be carried to the poles. However, both the transverse and oblique Mercator projections are used.

Conic projections with their axes parallel to the earth's polar axis are limited in their usefulness for polar charts because parallels of latitude extending through a full 360° of longitude appear as arcs of circles rather than full circles. This is because a cone, when cut along an element and flattened, does not extend through a full 360° without stretching or resuming its former conical shape. The usefulness of such projections is also limited by the fact that the pole appears as an arc of a circle instead of a point. However, by using a parallel very near the pole as the higher standard parallel, a conic projection with two standard parallels can be made. This requires little stretching to complete the circles of the parallels and eliminate that of the pole. Such a projection, called a **modified Lambert conformal** or **Ney's projection**, is useful for polar charts. It is particularly familiar to those accustomed to using the ordinary Lambert conformal charts in lower latitudes.

Azimuthal projections are in their simplest form when

tangent at a pole. This is because the meridians are straight lines intersecting at the pole, and parallels are concentric circles with their common center at the pole. Within a few degrees of latitude of the pole they all look similar; however, as the distance becomes greater, the spacing of the parallels becomes distinctive in each projection. In the polar azimuthal equidistant it is uniform; in the polar stereographic it increases with distance from the pole until the equator is shown at a distance from the pole equal to twice the length of the radius of the earth; in the polar gnomonic the increase is considerably greater, becoming infinity at the equator; in the polar orthographic it decreases with distance from the pole (Figure 420). All of these but the last are used for polar charts.

421. Selection of a Polar Projection

The principal considerations in the choice of a suitable projection for polar navigation are:

1. Conformality: When the projection represents angles correctly, the navigator can plot directly on the chart.
2. Great circle representation: Because great circles are more useful than rhumb lines at high altitudes, the projection should represent great circles as straight lines.
3. Scale variation: The projection should have a constant scale over the entire chart.
4. Meridian representation: The projection should show straight meridians to facilitate plotting and grid navigation.
5. Limits: Wide limits reduce the number of projections needed to a minimum.

The projections commonly used for polar charts are the modified Lambert conformal, gnomonic, stereographic, and azimuthal equidistant. All of these projections are similar near the pole. All are essentially conformal, and a great circle on each is nearly a straight line.

As the distance from the pole increases, however, the distinctive features of each projection become important. The modified Lambert conformal projection is virtually conformal over its entire extent. The amount of its scale distortion is comparatively little if it is carried only to about 25° or 30° from the pole. Beyond this, the distortion increases rapidly. A great circle is very nearly a straight line anywhere on the chart. Distances and directions can be measured directly on the chart in the same manner as on a Lambert conformal chart. However, because this projection is not strictly conformal, and on it great circles are not exactly represented by straight lines, it is not suited for highly

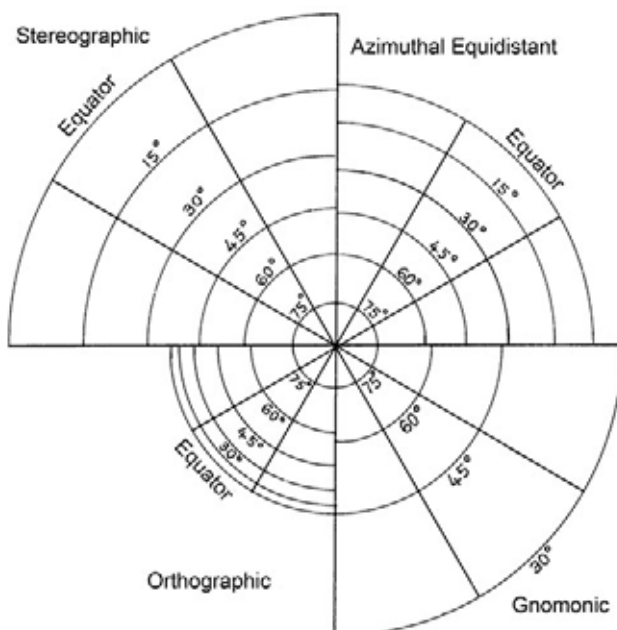

Figure 420. Expansion of polar azimuthal projections.

accurate work.

The polar gnomonic projection is the one polar projection on which great circles are exactly straight lines. However, a complete hemisphere cannot be represented upon a plane because the radius of 90° from the center would become infinity.

The polar stereographic projection is conformal over its entire extent, and a straight line closely approximates a great circle (see Figure 421). The scale distortion is not excessive for a considerable distance from the pole, but it is greater than that of the modified Lambert conformal projection.

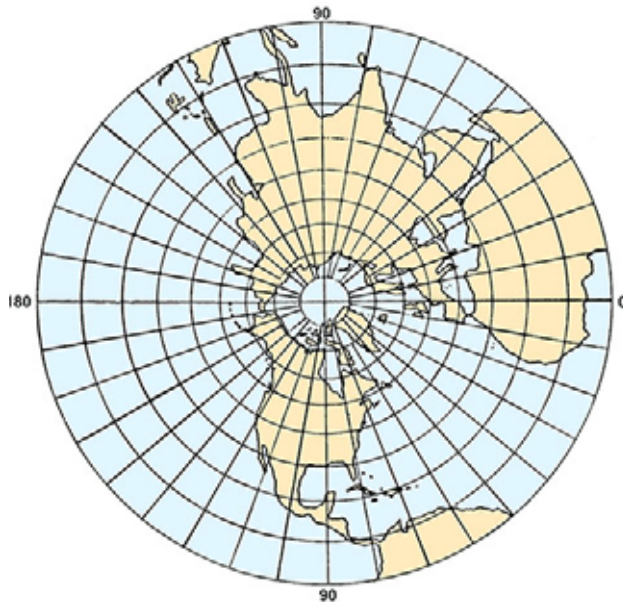

Figure 421. Polar stereographic projection.

The polar azimuthal equidistant projection is useful for showing a large area such as a hemisphere because there is no expansion along the meridians. However, the projection is not conformal and distances cannot be measured accurately in any but a north-south direction. Great circles other than the meridians differ somewhat from straight lines. The equator is a circle centered at the pole.

The two projections most commonly used for polar charts are the modified Lambert conformal and the polar stereographic. When a directional gyro is used as a directional reference, the track of the craft is approximately a great circle. A desirable chart is one on which a great circle is represented as a straight line with a constant scale and with angles correctly represented. These requirements are not met entirely by any single projection, but they are approximated by both the modified Lambert conformal and the polar stereographic. The scale is more nearly constant on the former, but the projection is not strictly conformal. The polar stereographic is conformal, and its maximum scale variation can be reduced by using a plane which intersects the earth at some parallel intermediate between the pole and the lowest parallel. The portion within this standard parallel is compressed, and that portion outside is expanded.

The selection of a suitable projection for use in polar regions depends upon mission requirements. These requirements establish the relative importance of various features. For a relatively small area, any of several projections is suitable. For a large area, however, the choice is more difficult. If grid directions are to be used, it is important that all units in related operations use charts on the same projection, with the same standard parallels, so that a single grid direction exists between any two points.

SPECIAL CHARTS

422. Plotting Sheets

Position plotting sheets are "charts" designed primarily for open ocean navigation, where land, visual aids to navigation, and depth of water are not factors in navigation. They have a latitude and longitude graticule, and they may have one or more compass roses. The meridians are usually unlabeled, so a plotting sheet can be used for any longitude. Plotting sheets on Mercator projection are specific to latitude, and the navigator should have enough aboard for all latitudes for their voyage. Plotting sheets are less expensive than charts.

A plotting sheet may be used in an emergency when charts have been lost or destroyed. Directions on how to construct plotting sheets suitable for emergency purposes are given in Chapter 26 - Emergency Navigation.

423. Grids

No system exists for showing the surface of the earth on a plane without distortion. Moreover, the appearance of the surface varies with the projection and with the relation of that surface area to the point of tangency. One may want to identify a location or area simply by alpha-numeric rectangular coordinates. This is accomplished with a **grid**. In its usual form this consists of two series of lines drawn perpendicularly on the chart, marked by suitable alpha-numeric designations.

A grid may use the rectangular graticule of the Mercator projection or a set of arbitrary lines on a particular projection. **The World Geodetic Reference System (GEOREF)** is a method of designating latitude and longitude by a system of letters and numbers instead of by angular measure. It is not, therefore, strictly a grid. It is use-

ful for operations extending over a wide area. Examples of the second type of grid are the **Universal Transverse Mercator (UTM)** grid, the **Universal Polar Stereographic (UPS)** grid, and the **Temporary Geographic Grid (TGG)**. Since these systems are used primarily by military forces, they are sometimes called military grids.

For more information on chart projections see The Map Projections Catalog. The catalog offers examples of a broad range of publicly available projection types.



Figure 423. Map Projections Catalog.
<http://www.csis.org/map-projections>.

CHART SCALES

424. Types Of Scales

The **scale** of a chart is the ratio of a given distance on the chart to the actual distance which it represents on the earth. It may be expressed in various ways. The most common are:

1. A simple ratio or fraction, known as the **representative fraction**. For example, 1:80,000 or 1/80,000 means that one unit (such as a meter) on the chart represents 80,000 of the same unit on the surface of the earth. This scale is sometimes called the **natural** or **fractional** scale.
2. A **statement** that a given distance on the earth equals a given measure on the chart, or vice versa. For example, “30 miles to the inch” means that 1 inch on the chart represents 30 miles of the earth’s surface. Similarly, “2 inches to a mile” indicates that 2 inches on the chart represent 1 mile on the earth. This is sometimes called the **numerical scale**.
3. A line or bar called a **graphic scale** may be drawn at a convenient place on the chart and subdivided into nautical miles, meters, etc. All charts vary somewhat in scale from point to point, and in some projections the scale is not the same in all directions about a single point. A single subdivided line or bar for use over an entire chart is shown only when the chart is of such scale and projection that the scale varies a negligible amount over the chart, usually one of about 1:75,000 or larger. Since 1 minute of latitude is very nearly equal to 1 nautical mile, the latitude scale serves as an approximate graphic scale. On most nautical charts the east and west borders are subdivided to facilitate distance measurements.

On a Mercator chart the scale varies with the latitude. This is noticeable on a chart covering a relatively large distance in a north-south direction. On such a chart the border scale nearest the latitude in question should be used for measuring distances.

Of the various methods of indicating scale, the graphical method is normally available in some form on the chart. In addition, the scale is customarily stated on charts on

which the scale does not change appreciably over the chart.

The ways of expressing the scale of a chart are readily interchangeable. For instance, in a nautical mile there are about 72,913.39 inches. If the natural scale of a chart is 1:80,000, one inch of the chart represents 80,000 inches of the earth, or a little more than a mile. To find the exact amount, divide the scale by the number of inches in a mile, or $80,000/72,913.39 = 1.097$. Thus, a scale of 1:80,000 is the same as a scale of 1.097 (or approximately 1.1) miles to an inch. Stated another way, there are: $72,913.39/80,000 = 0.911$ (approximately 0.9) inch to a mile. Similarly, if the scale is 60 nautical miles to an inch, the representative fraction is $1:(60 \times 72,913.39) = 1:4,374,803$.

A chart covering a relatively large area is called a **small-scale chart** and one covering a relatively small area is called a **large-scale chart**. Since the terms are relative, there is no sharp division between the two. Thus, a chart of scale 1:100,000 is large scale when compared with a chart of 1:1,000,000 but small scale when compared with one of 1:25,000.

As scale decreases, the amount of detail which can be shown decreases also. Cartographers selectively decrease the detail in a process called **generalization** when producing small scale charts using large scale charts as sources. The amount of detail shown depends on several factors, among them the coverage of the area at larger scales and the intended use of the chart.

425. Chart Classification by Scale

Charts are constructed on many different scales, ranging from about 1:2,500 to 1:14,000,000. Small-scale charts covering large areas are used for route planning and for off-shore navigation. Charts of larger scale, covering smaller areas, are used as the vessel approaches land. Several methods of classifying charts according to scale are used in various nations. The following classifications of nautical charts are used by the National Ocean Service (NOS).

Sailing charts are the smallest scale charts used for planning, fixing position at sea, and for plotting the dead reckoning while proceeding on a long voyage. The scale is generally smaller than 1:600,000. The shoreline and topog-

raphy are generalized and only offshore soundings, principal navigational lights, outer buoys, and landmarks visible at considerable distances are shown.

General charts are intended for coastwise navigation outside of outlying reefs and shoals. The scales range from about 1:150,000 to 1:600,000.

Coastal charts are intended for inshore coastwise navigation, for entering or leaving bays and harbors of considerable width, and for navigating large inland waterways. The scales range from about 1:50,000 to 1:150,000.

Harbor charts are intended for navigation and anchorage in harbors and small waterways. The scale is generally larger than 1:50,000.

In the classification system used by the National Geospatial-Intelligence Agency (NGA), the sailing charts are incorporated in the general charts classification (smaller than about 1:150,000); those coastal charts especially useful for approaching more confined waters (bays, harbors) are classified as approach charts. There is considerable overlap in these designations, and the classification of a chart is best determined by its purpose and its relationship to other charts of the area. The use of insets complicates the placement of charts into rigid classifications.

426. Small-Craft Charts

NOS publishes a series of small craft charts sometimes called “strip charts.” These charts depict segments of the Atlantic Intracoastal Waterway, the Gulf Intracoastal Waterway and other inland routes used by yachtsmen, fishermen, and small commercial vessels for coastal travel. They are not “north-up” in presentation, but are aligned with the waterway they depict, whatever its orientation is. Most often they are used as a piloting aid for “eyeball” navigation and placed “course-up” in front of the helmsman, because the routes they show are too confined for taking and plotting fixes.

Although NOS small-craft charts are designed primarily for use aboard yachts, fishing vessels and other small craft, these charts, at scales of 1:80,000 and larger, are in some cases the only charts available depicting inland waters transited by large vessels. In other cases the small-craft charts may provide a better presentation of navigational hazards than the standard nautical chart because of better scale and more detail. Therefore, navigators should use these charts in areas where they provide the best coverage.

CHART ACCURACY

427. Factors Relating to Accuracy

The accuracy of a chart depends upon the accuracy of the hydrographic surveys and other data sources used to compile it and the suitability of its scale for its intended use.

One can sometimes estimate the accuracy of a chart’s surveys from the source notes given in the title of the chart. If the chart is based upon very old surveys, use it with caution. Many early surveys were inaccurate because of the technological limitations of the surveyor.

The number of soundings and their spacing indicates the completeness of the survey. Only a small fraction of the soundings taken in a thorough survey are shown on the chart, but sparse or unevenly distributed soundings indicate that the survey was probably not made in detail. See Figure 427a and Figure 427b. Large blank areas or absence of depth contours generally indicate lack of soundings in the area. Operate in an area with sparse sounding data only if required and then only with extreme caution. Run the echo sounder continuously and operate at a reduced speed. Sparse sounding information does not necessarily indicate an incomplete survey. Relatively few soundings are shown when there is a large number of depth contours, or where the bottom is flat, or gently and evenly sloping. Additional soundings are shown when they are helpful in indicating the uneven character of a rough bottom.

Even a detailed survey may fail to locate every rock or pinnacle. In waters where they might be located, the best method for finding them is a wire drag survey. Areas that

have been dragged may be indicated on the chart by limiting lines and green or purple tint and a note added to show the effective depth at which the drag was operated.

Changes in bottom contours are relatively rapid in areas such as entrances to harbors where there are strong currents or heavy surf. Similarly, there is sometimes a tendency for dredged channels to shoal, especially if they are surrounded by sand or mud, and cross currents exist. Charts often contain notes indicating the bottom contours are known to change rapidly.

The same detail cannot be shown on a small-scale chart as on a large scale chart. On small-scale charts, detailed information is omitted or “generalized” in the areas covered by larger scale charts. The navigator should use the largest scale chart available for the area in which he or she is operating, especially when operating in the vicinity of hazards.

Charting agencies continually evaluate both the detail and the presentation of data appearing on a chart. Development of a new navigational aid may render previous charts inadequate. The development of radar, for example, required upgrading charts which lacked the detail required for reliable identification of radar targets.

After receiving a chart, the user is responsible for keeping it updated. Mariner’s reports of errors, changes, and suggestions are useful to charting agencies. Even with modern automated data collection techniques, there is no substitute for on-sight observation of hydrographic conditions by experienced mariners. This holds true especially in

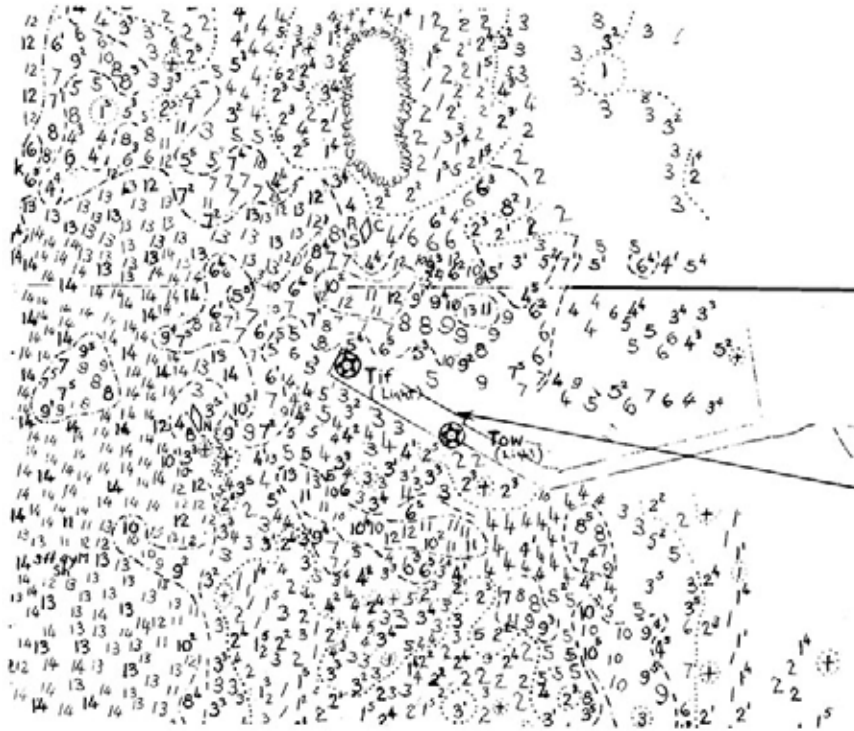

Figure 427a. Part of a "boat sheet," showing the soundings obtained in a survey.

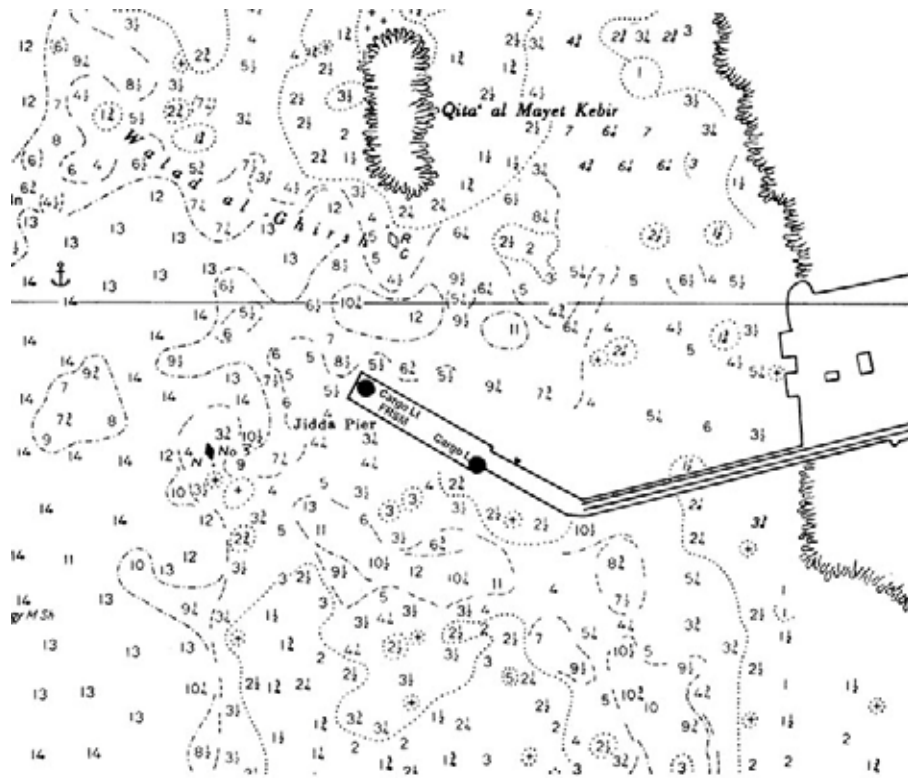

Figure 427b. Part of a nautical chart made from the boat sheet of Figure 427a. Compare the number of soundings in the two figures.

less frequently traveled areas of the world.

428. Source Diagrams and Zones of Confidence

All charts, whether paper or electronic, contain data which varies in quality due to the age and accuracy of individual surveys. A chart can be considered as a patchwork of individual surveys pieced together to form a single image. A **source diagram** only shows who supplied a survey, and possibly how old that survey is, but provides nothing about the quality of the survey. Where source diagrams are based on inexact and sometimes subjective parameters, a new **zone of confidence (ZOC)** system (exclusive to electronic charts in the United States) is derived more consistently, using a combination of survey data, position accuracy, depth accuracy, and sea floor coverage.

The ZOC assessments within each chart enable mariners to assess the limitation of the hydrographic data from which the chart was compiled and to assess the associated level of risk to navigate in a particular area. In ENC the various assessment areas and ratings appear across the entirety of the ENC and are therefore embedded in their true posi-

tions, rather than in a small diagram. This information layer can be displayed or hidden as planning and route monitoring requirements change.

Assessments are made based upon four criteria, following which a single ZOC rating is derived for each area of differing quality, based upon the lowest individually assessed criteria for that area. Individual criteria are:

1. Position accuracy.
2. Depth accuracy (in reference to what has been detected, not what might or might not have been missed).
3. Seafloor coverage, i.e. the certainty of feature detection (this is not related to depth accuracy, but relates only to what might or might not have been missed).
4. Typical survey characteristics.

Of these, the most important is the assessment of sea-floor coverage, as this determines how much clearance should be maintained between a ship's keel and the seabed in most areas, and where any additional precautions may need to be taken.

Each surveyed area will be assigned to one of five

<i>ZOC</i>	<i>Position Accuracy</i>	<i>Depth Accuracy</i>		<i>Seafloor Coverage</i>	<i>Typical Survey Characteristics</i>
A1	± 5 m	= 0.50 + 1% d		Full area search undertaken. All significant seafloor features detected and depths measured.	Controlled, systematic survey high position and depth accuracy achieved using DGPS or a minimum three high quality lines of position (LOP) and a multibeam, channel or mechanical sweep system.
		Depth (m)	Accuracy (m)		
		10	± 0.6		
		30	± 0.8		
		1000	± 10.5		
A2	± 20 m	= 1.00 + 2% d		Full area search undertaken. All significant seafloor features detected and depths measured.	Controlled, systematic survey high position and depth accuracy achieved less than ZOC A1 and using a modern survey echosounder and a sonar or mechanical system.
		Depth (m)	Accuracy (m)		
		10	± 1.2		
		30	± 1.6		
		1000	± 21.0		
B	± 50 m	= 1.00 + 2% d		Full area search not achieved; uncharted features, hazardous to surface navigation are not expected but may exist.	Controlled systematic survey achieving similar depth but lesser position accuracies than ZOC A2, using modern survey echosounder, but no sonar or mechanical sweep system.
		Depth (m)	Accuracy (m)		
		10	± 1.2		
		30	± 1.6		
		1000	± 21.0		

Table 428. Zones of Confidence category explanations.

<i>ZOC</i>	<i>Position Accuracy</i>	<i>Depth Accuracy</i>		<i>Seafloor Coverage</i>	<i>Typical Survey Characteristics</i>
C	± 500 m	= 2.00 + 5% d		Full area search not achieved, depth anomalies may be expected.	Low accuracy survey or data collected on an opportunity basis such as soundings on passage.
		Depth (m)	Accuracy (m)		
		10	± 2.5		
		30	± 3.5		
		100	± 7.0		
		1000	± 52.0		
D	Worse than ZOC	Worse than ZOC C		Full area search not achieved, large depth	Poor quality data or data that cannot be quality assessed due
U	Unassessed - The quality of the bathymetric data has yet to be assessed				

Table 428. Zones of Confidence category explanations.

quality categories for assessed data (ZOC A1, A2, B, C, D), with a sixth category used for data which has not been assessed (ZOC U). See Table 428 for an explanation of each

category. The standard is detailed in the International Hydrographic Organization (IHO) S-57 Edition 3.1 Supplement 2, publication.

CHART READING

429. Chart Dates

NOAA charts have two dates. At the top center of the chart is the date of the first edition of the chart. In the lower left corner of the chart is the current edition number and date. This date shows the latest date through which *Notice to Mariners* were applied to the chart. Any subsequent change will be published in the *Notice to Mariners*. Any notices which accumulate between the chart date and the announcement date in the *Notice to Mariners* will be given with the announcement. Comparing the dates of the first and current editions gives an indication of how often the chart is updated. Charts of busy areas are updated more frequently than those of less traveled areas. This interval may vary from 6 months to more than ten years for NOAA charts, and may be much longer for certain NGA charts in remote areas.

New editions of charts are both demand and source driven. Receiving significant new information may or may not initiate a new edition of a chart, depending on the demand for that chart. If it is in a sparsely-traveled area, production priorities may delay a new edition for several years. Conversely, a new edition may be printed without the receipt of significant new data if demand for the chart is high and stock levels are low. *Notice to Mariners* corrections are always included on new editions.

NGA charts have the same two dates as the NOAA charts, the current chart edition number and date are given in the lower left corner. Certain NGA charts are reproduc-

tions of foreign charts produced under joint agreements with a number of other countries. These charts, even though of recent date, may be based on foreign charts of a considerably earlier date. Further, new editions of the foreign chart will not necessarily result in a new edition of the NGA reproduction, especially in cases where the foreign chart is the better chart to use.

430. Title Block

The chart title block should be the first thing a navigator looks at when receiving a new edition chart (refer to Figure 430). The title itself tells what area the chart covers. The chart's scale and projection appear below the title. The chart will give both vertical and horizontal datums and, if necessary, a datum conversion note. Source notes or diagrams will list the date of surveys and other charts used in compilation.

431. Shoreline

The shoreline shown on nautical charts represents the line of contact between the land and water at a selected vertical datum. In areas affected by tidal fluctuations, this is usually the mean high-water line. In confined coastal waters of diminished tidal influence, a mean water level line may be used. The shoreline of interior waters (rivers, lakes) is usually a line representing a specified elevation above a selected datum. A shoreline is symbolized by a heavy line.

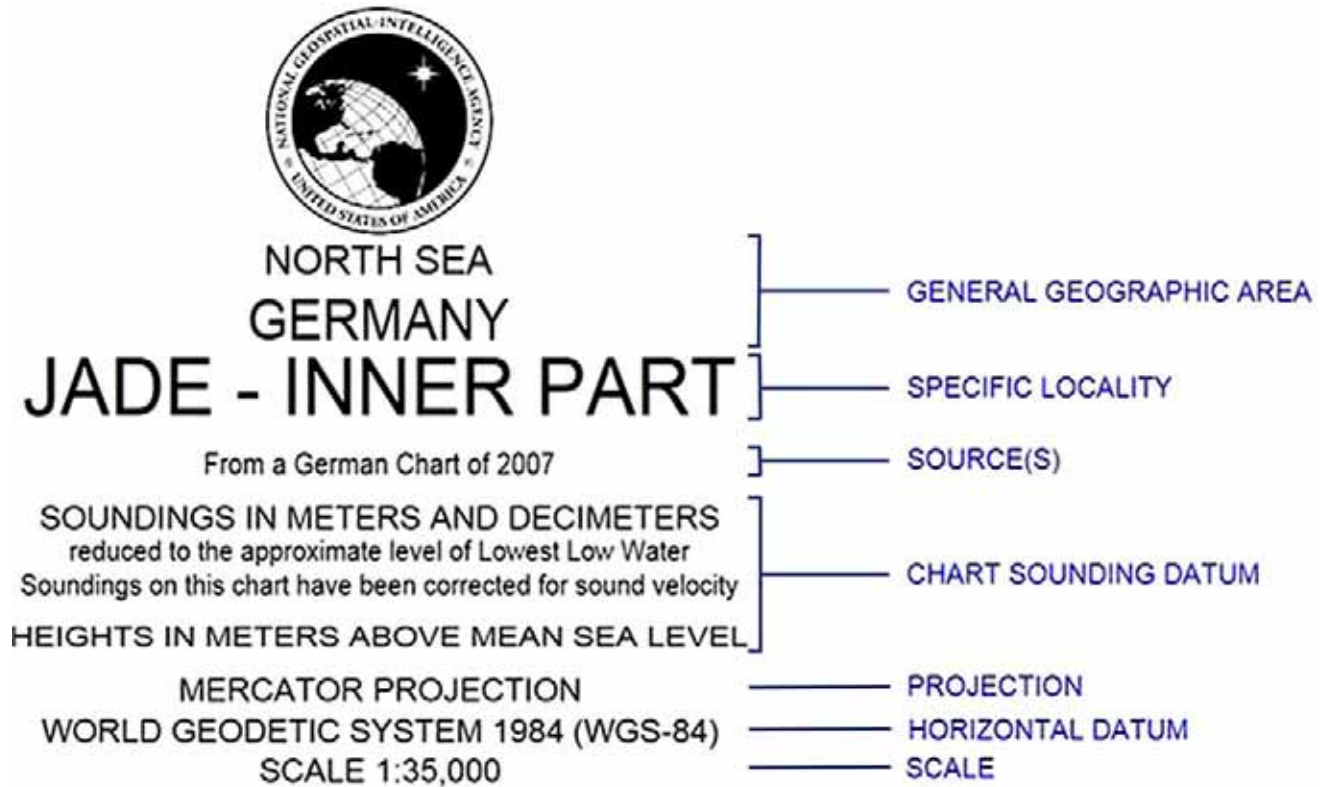

Figure 430. A chart title block.

A broken line indicates that the charted position is approximate only. The nature of the shore may be indicated.

If the low water line differs considerably from the high water line, then a dotted line represents the low water line. If the bottom in this area is composed of mud, sand, gravel or stones, the type of material will be indicated. If the bottom is composed of coral or rock, then the appropriate symbol will be used. The area alternately covered and uncovered may be shown by a tint which is usually a combination of the land and water tint.

The apparent shoreline shows the outer edge of marine vegetation where that limit would appear as shoreline to the mariner. It is also used to indicate where marine vegetation prevents the mariner from defining the shoreline. A light line symbolizes this shoreline. A broken line marks the inner edge when no other symbol (such as a cliff or levee) furnishes such a limit. The combined land-water tint or the land tint marks the area between inner and outer limits.

432. Chart Symbols

Much of the information contained on charts is shown by symbols. These symbols are not shown to scale, but they indicate the correct position of the feature to which they refer. The standard symbols and abbreviations used on charts published by the United States of

America are shown in *Chart No. 1, Nautical Chart Symbols and Abbreviations*. See Figure 432 for link.



Figure 432. Link to Chart No. 1.

https://msi.nga.mil/NGAPortal/MSIpo.rtal?_nfpb=true&_pageLabel=msi_portal_page_62&pubCode=0004

Electronic chart symbols are, within programming and display limits, much the same as printed ones. The less expensive electronic charts have less extensive symbol libraries, and the screen's resolution may affect the presentation detail.

Most of the symbols and abbreviations shown in U.S. *Chart No. 1* agree with recommendations of the International Hydrographic Organization (IHO). The layout is explained in the general remarks section of *Chart No. 1*.

The symbols and abbreviations on any given chart may differ somewhat from those shown in *Chart No. 1*. In

addition, foreign charts may use different symbology. When using a foreign chart, the navigator should have available the *Chart No. 1* from the country which pro-

duced the chart.

Section Key

A		Chart Number, Title and Marginal Notes	INT 500 412 Mercator Projection Scale 1:100,000 (2.4 UK 59'30") 7th Ed., Mar. 5/09 DEPTHS IN METERS
B		Positions, Distances, Directions and Compass	 ±15° Magnetic Variation 4°30' W 2011 (W/E) LOCAL MAGNETIC ANOMALY (see note)
C		Natural Features	
D		Cultural Features	
E		Landmarks	
F		Ports	
H		Tides and Currents	
I		Depths	
J		Nature of the Seabed	
K		Rocks, Wrecks and Obstructions	
L		Offshore Installations	
M		Tracks and Routes	
N		Areas and Limits	
P		Lights	
Q		Buoys and Beacons	
R		Fog Signals	
S		Radar, Radio and Satellite Navigation Systems	
T		Services	
U		Small Craft (Leisure) Facilities	

Figure 432. Contents of U.S. Chart No. 1.

Chart No. 1 is organized according to subject matter, with each specific subject given a letter designator. The general subject areas are General, Topography, Hydrography, Aids and Services, and Indexes. Under each heading, letter designators further define subject areas, and individual numbers refer to specific symbols.

Information in *Chart No. 1* is arranged in columns. The first column contains the IHO number code for the symbol in question. The next two columns show the symbol itself, in NOS and NGA formats. If the formats are the same, the two columns are combined into one. The next column is a text description of the symbol, term, or abbreviation. The next three columns contain the IHO standard symbolized on charts produced by NOAA or NGA. The last column contains the symbol used on electronic charts displayed on an ECDIS with a text description to the right of the symbol.

433. Lettering

Except on some modified reproductions of foreign charts, cartographers have adopted certain lettering standards. Vertical type is used for features which are dry at high water and not affected by movement of the water; slanting type is used for underwater and floating features.

There are two important exceptions to the two general rules listed above. Vertical type is not used to represent heights above the waterline, and slanting type is not used to indicate soundings, except on metric charts. Section 434 discusses the conventions for indicating soundings.

Evaluating the type of lettering used to denote a feature, one can determine whether a feature is visible at high tide. For instance, a rock might bear the title "Rock" whether or not it extends above the surface. If the name is given in vertical letters, the rock constitutes a small islet; if in slanting type, the rock constitutes a reef, covered at high water.

434. Soundings

Charts show soundings in several ways. Numbers denote individual soundings. These numbers may be either vertical or slanting; both may be used on the same chart, distinguishing between data based upon different U.S. and foreign surveys, different datums, or smaller scale charts.

Large block letters at the top and bottom of the chart indicate the unit of measurement used for soundings. SOUNDINGS IN FATHOMS indicates soundings are in fathoms or fathoms and fractions. SOUNDINGS IN FATHOMS AND FEET indicates the soundings are in fathoms and feet. A similar convention is followed when the soundings are in meters or meters and tenths.

A **depth conversion scale** is placed outside the neat-line on the chart for use in converting charted depths to feet, meters, or fathoms. "No bottom" soundings are indicated by a number with a line over the top and a dot over the line. This indicates that the spot was sounded to the depth indicated without reaching the bottom. Areas which have been wire dragged are shown by a broken limiting line, and the clear effective depth is indicated, with a characteristic symbol under the numbers. On NGA charts a purple or green tint is shown within the swept area.

Soundings are supplemented by **depth contours**, lines connecting points of equal depth. These lines present a picture of the bottom. The types of lines used for various depths are shown in Section I of *Chart No. 1*. On some charts depth contours are shown in solid lines; the depth represented by each line is shown by numbers placed in breaks in the lines, as with land contours. Solid line depth contours are derived from intensively developed hydrographic surveys. A broken or indefinite contour is substituted for a solid depth contour whenever the reliability of the contour is questionable.

Depth contours are labeled with numerals in the unit of measurement of the soundings. A chart presenting a more detailed indication of the bottom configuration with fewer numerical soundings is useful when bottom contour navigating. Such a chart can be made only for areas which have undergone a detailed survey.

Shoal areas often are given a blue tint. Charts designed to give maximum emphasis to the configuration of the bottom show depths beyond the 100-fathom curve over the entire chart by depth contours similar to the contours shown on land areas to indicate graduations in height. These are called **bottom contour** or **bathymetric charts**.

On electronic charts, a variety of other color schemes may be used, according to the manufacturer of the system. Color perception studies are being used to determine the best presentation.

The side limits of dredged channels are indicated by broken lines. The project depth and the date of dredging, if known, are shown by a statement in or along the channel. The possibility of silting is always present. Local authorities should be consulted for the controlling depth. NOS charts frequently show controlling depths in a table, which is kept current by the *Notice to Mariners*.

The chart scale is generally too small to permit all soundings to be shown. In the selection of soundings, least depths are shown first. This conservative sounding pattern provides safety and ensures an uncluttered chart appearance. Steep changes in depth may be indicated by more dense soundings in the area. The limits of shoal water indicated on the chart may be in error, and nearby areas of undetected shallow water may not be included on the chart. Given this possibility, areas where shoal water is known to exist should be avoided. If the navigator must enter an area containing shoals, they must exercise extreme caution in avoiding shallow areas which may have escaped detection. By constructing a "safety range" around known shoals and ensuring their vessel does not approach the shoal any closer than the safety range, the navigator can increase their chances of successfully navigating through shoal water. Constant use of the echo sounder is also important.

Abbreviations listed in Section J of *Chart No. 1* are used to indicate what substance forms the bottom. The meaning of these terms can be found in the Glossary of this volume. While in ages past navigators might actually navigate by knowing the bottom characteristics of certain local areas, today knowing the characteristic of the bottom is most important when anchoring.

435. Depths and Datums

Depths are indicated by soundings or explanatory notes. Only a small percentage of the soundings obtained in a hydrographic survey can be shown on a nautical chart. The least depths are generally selected first, and a pattern built around them to provide a representative indication of bottom relief. In shallow water, soundings may be spaced 0.2 to 0.4 inch apart. The spacing is gradually increased as water deepens, until a spacing of 0.8 to 1.0 inch is reached in deeper waters offshore. Where a sufficient number of soundings are available to permit adequate interpretation, depth curves are drawn in at selected intervals.

All depths indicated on charts are reckoned from a selected level of the water, called the **sounding datum**, (sometimes referred to as the **reference plane** to distinguish this term from the geodetic datum). The various sounding datums are explained in Chapter 35- Tides and Tidal Currents. On charts produced from U.S. surveys, the sounding datum is selected with regard to the tides of the region. Depths shown are the least depths to be expected under average conditions. On charts compiled from foreign charts and surveys the sounding datum is that of the original authority. When it is known, the sounding datum used is stated on the chart. In some cases where the chart is based upon old surveys, particularly in areas where the range of tide is not great, the sounding datum may not be known.

For most NOAA charts of the United States and Puerto Rico, the sounding datum is indicated as Mean Lower Low Water (MLLW). Most NGA charts are based upon mean low water, mean lower low water, or mean low water springs. The sounding datum for charts published by other countries

varies greatly, but is usually lower than mean low water. On charts of the Baltic Sea, Black Sea, the Great Lakes, and other areas where tidal effects are small or without significance, the sounding datum adopted is an arbitrary height approximating the mean water level.

The sounding datum of the largest scale chart of an area is generally the same as the reference level from which height of tide is tabulated in the tide tables.

The chart datum is usually only an approximation of the actual mean value, because determination of the actual mean height usually requires a longer series of tidal observations than is normally available to the cartographer. In addition, the heights of the tide vary over time.

Since the chart datum is generally a computed mean or average height at some state of the tide, the depth of water at any particular moment may be less than shown on the chart. For example, if the chart datum is mean lower low water, the depth of water at lower low water will be less than the charted depth about as often as it is greater. A lower depth is indicated in the tide tables by a minus sign (-).

436. Heights

The shoreline shown on charts is generally mean high water. A light's height is usually reckoned from mean sea level. The heights of overhanging obstructions (bridges, power cables, etc.) are usually reckoned from mean high water. A high water reference gives the mariner the minimum clearance expected.

Since heights are usually reckoned from high water and depths from some form of low water, the reference levels are seldom the same. Except where the range of tide is very large, this is of little practical significance.

437. Dangers

Dangers are shown by appropriate symbols, as indicated in Section K of *Chart No. 1*.

A rock uncovered at mean high water may be shown as an islet. If an isolated, offlying rock is known to uncover at the sounding datum but to be covered at high water, the chart shows the appropriate symbol for a rock and gives the height above the sounding datum. The chart can give this height one of two ways. It can use a statement such as "Uncov 2 ft.," or it can indicate the number of feet the rock protrudes above the sounding datum, underline this value, and enclose it in parentheses (i.e. (2)). A rock which does not uncover is shown by an enclosed figure approximating its dimensions and filled with land tint. It may be enclosed by a dotted depth curve for emphasis.

A tinted, irregular-line figure of approximately true dimensions is used to show a detached coral reef which uncovers at the chart datum. For a coral or rocky reef which is submerged at chart datum, the sunken rock symbol or an appropriate statement is used, enclosed by a dotted or broken line if the limits have been determined.

Several different symbols mark wrecks. The nature of the wreck or scale of the chart determines the correct symbol. A sunken wreck with less than 30 meters of water over it is considered dangerous and its symbol is surrounded by a dotted curve. The curve is omitted if the wreck is deeper than 30 meters. The safe clearance over a wreck, if known, is indicated by a standard sounding number placed at the wreck. If this depth was determined by a wire drag, the sounding is underscored by the wire drag symbol. An unsurveyed wreck over which the exact depth is unknown but a safe clearance depth is known is depicted with a solid line above the symbol.

Tide rips, eddies, and kelp are shown by symbol or legend. Piles, dolphins (clusters of piles), snags, and stumps are shown by small circles and a label identifying the type of obstruction. If such dangers are submerged, the letters "Subm" precede the label. Fish stakes and traps are shown when known to be permanent or hazardous to navigation.

438. Aids to Navigation

Aids to navigation are shown by symbols listed in Sections P through S of *Chart No. 1*. Abbreviations and additional descriptive text supplement these symbols. In order to make the symbols conspicuous, the chart shows them in size greatly exaggerated relative to the scale of the chart. "Position approximate" circles are used on floating aids to indicate that they have no exact position because they move around their moorings. For most floating aids, the position circle in the symbol marks the approximate location of the anchor or sinker. The actual aid may be displaced from this location by the scope of its mooring.

The type and number of aids to navigation shown on a chart and the amount of information given in their legends varies with the scale of the chart. Smaller scale charts may have fewer aids indicated and less information than larger scale charts of the same area.

Lighthouses and other navigation lights are shown as black dots with purple disks or as black dots with purple flare symbols. The center of the dot is the position of the light. Some modified facsimile foreign charts use a small star instead of a dot.

On large-scale charts the legend elements of lights are shown in the following order:

<i>Legend</i>	<i>Example</i>	<i>Meaning</i>
Designation	"6"	Light number 6
Characteristic	F1(2)	group flashing; 2 flashes
Color	R	red
Period	10s	2 flashes in 10 seconds
Height	80m	80 meters
Range	19M	19 nautical miles

The legend characteristics for this light would appear on the chart:

“6” Fl(2) R 10s 80m 19M

As chart scale decreases, information in the legend is selectively deleted to avoid clutter. The order of deletion is usually height first, followed by period, group repetition interval (e.g. (2)), designation, and range. Characteristic and color will almost always be shown.

Small triangles mark red daybeacons; small squares mark all others. On NGA charts, pictorial beacons are used when the IALA buoyage system has been implemented. The center of the triangle marks the position of the aid. Except on Intracoastal Waterway charts and charts of state waterways, the abbreviation “Bn” is shown beside the symbol, along with the appropriate abbreviation for color if known. For black beacons the triangle is solid black and there is no color abbreviation. All beacon abbreviations are in vertical lettering.

Radiobeacons are indicated on the chart by a purple circle accompanied by the appropriate abbreviation indicating an ordinary radiobeacon (R Bn) or a radar beacon (Rmark or Racon, for example).

A variety of symbols, determined by both the charting agency and the types of buoys, indicate navigation buoys. IALA buoys (see Chapter 7- Short Range Aids to Navigation) in foreign areas are depicted by various styles of symbols with proper topmarks and colors; the position circle which shows the approximate location of the sinker is at the base of the symbol.

A mooring buoy is shown by one of several symbols as indicated in *Chart No. 1*. It may be labeled with a berth number or other information.

A buoy symbol with a horizontal line indicates the buoy has horizontal bands. A vertical line indicates vertical stripes; crossed lines indicate a checked pattern. There is no significance to the angle at which the buoy symbol appears on the chart. The symbol is placed so as to avoid interference with other features.

Lighted buoys are indicated by a purple flare from the buoy symbol or by a small purple disk centered on the position circle.

Abbreviations for light legends, type and color of buoy, designation, and any other pertinent information given near the symbol are in slanted type. The letter C, N, or S indicates a can, nun, or spar, respectively. Other buoys are assumed to be pillar buoys, except for special buoys such as spherical, barrel, etc. The number or letter designation of the buoy is given in quotation marks on NOS charts. On other charts they may be given without quotation marks or other punctuation.

Aeronautical lights included in the light lists are shown by the lighthouse symbol, accompanied by the abbreviation “AERO.” The characteristics shown depend principally upon the effective range of other navigational lights in the vicinity and the usefulness of the light for marine navigation.

Directional ranges are indicated by a broken or solid line. The solid line, indicating that part of the range intended for navigation, may be broken at irregular intervals to avoid being drawn through soundings. That part of the range line drawn only to guide the eye to the objects to be kept in range is broken at regular intervals. The direction, if given, is expressed in degrees, clockwise from true north.

Sound signals are indicated by the appropriate word in capital letters (HORN, BELL, GONG, or WHIS) or an abbreviation indicating the type of sound. Sound signals of any type except submarine sound signals may be represented by three purple 45° arcs of concentric circles near the top of the aid. These are not shown if the type of signal is listed. The location of a sound signal which does not accompany a visual aid, either lighted or unlighted, is shown by a small circle and the appropriate word in vertical block letters.

Private aids, when shown, are marked “Priv” on NOS charts. Some privately maintained unlighted fixed aids are indicated by a small circle accompanied by the word “Marker,” or a larger circle with a dot in the center and the word “MARKER.” A privately maintained lighted aid has a light symbol and is accompanied by the characteristics and the usual indication of its private nature. Private aids should be used with caution.

A light sector is the sector or area bounded by two radii and the arc of a circle in which a light is visible or in which it has a distinctive color different from that of adjoining sectors. The limiting radii are indicated on the chart by dotted or dashed lines. Sector colors are indicated by words spelled out if space permits, or by abbreviations (W, R, etc.) if it does not. Limits of light sectors and arcs of visibility as observed from a vessel are given in the light lists, in clockwise order.

439. Land Areas

The amount of detail shown on the land areas of nautical charts depends upon the scale and the intended purpose of the chart. Contours, form lines, and shading indicate relief.

Contours are lines connecting points of equal elevation. Heights are usually expressed in feet (or in meters with means for conversion to feet). The interval between contours is uniform over any one chart, except that certain intermediate contours are sometimes shown by broken line. When contours are broken, their locations are approximate.

Form lines are approximations of contours used for the purpose of indicating relative elevations. They are used in areas where accurate information is not available in sufficient detail to permit exact location of contours. Elevations of individual form lines are not indicated on the chart.

Spot elevations are generally given only for summits or for tops of conspicuous landmarks. The heights of spot elevations and contours are given with reference to mean high water when this information is available.

When there is insufficient space to show the heights of islets or rocks, they are indicated by slanting figures en-

closed in parentheses in the water area nearby.

440. Cities and Roads

Cities are shown in a generalized pattern that approximates their extent and shape. Street names are generally not charted except those along the waterfront on the largest scale charts. In general, only the main arteries and thoroughfares or major coastal highways are shown on smaller scale charts. Occasionally, highway numbers are given. When shown, trails are indicated by a light broken line. Buildings along the waterfront or individual ones back from the waterfront but of special interest to the mariner are shown on large-scale charts. Special symbols from *Chart No. 1* are used for certain kinds of buildings. A single line with cross marks indicates both single and double track railroads. City electric railways are usually not charted. Airports are shown on small-scale charts by symbol and on large-scale charts by the shape of runways. The scale of the chart determines if single or double lines show breakwaters and jetties; broken lines show the submerged portion of these features.

441. Landmarks

Landmarks are shown by symbols in *Chart No. 1*.

A large circle with a dot at its center is used to indicate that the position is precise and may be used without reservation for plotting bearings. A small circle without a dot is used for landmarks not accurately located. Capital and lower case letters are used to identify an approximate landmark: “Mon,” “Cup,” or “Dome.” The abbreviation “PA” (position approximate) may also appear. An accurate landmark is identified by all capital type (“MON,” “CUP,” “DOME”).

When only one object of a group is charted, its name is followed by a descriptive legend in parenthesis, including the number of objects in the group, for example “(TALLEST OF FOUR)” or “(NORTHEAST OF THREE).”

442. Miscellaneous Chart Features

A measured nautical mile indicated on a chart is accurate to within 6 feet of the correct length. Most measured miles in the United States were made before 1959, when the United States adopted the International Nautical Mile. The new value is within 6 feet of the previous standard length of 6,080.20 feet. If the measured distance differs from the standard value by more than 6 feet, the actual measured distance is stated and the words “measured mile” are omitted. Periods after abbreviations in water areas are omitted

TIDAL INFORMATION						
Place	Position		Height above datum of soundings			
			Mean High Water		Mean Low Water	
	N. Lat.	E. Long.	Higher	Lower	Lower	Higher
			meters	meters	meters	meters
Olongapo	14°49'	120°17'	. . . 0.9 0.4 0.0 0.3 . . .

Figure 442a. Tidal box.

because these might be mistaken for rocks. However, a lower case i or j is dotted.

Commercial radio broadcasting stations are shown on charts when they are of value to the mariner either as landmarks or sources of direction-finding bearings.

Lines of demarcation between the areas in which international and inland navigation rules apply are shown only when they cannot be adequately described in notes on the chart.

Compass roses are placed at convenient locations on Mercator charts to facilitate the plotting of bearings and courses. The outer circle is graduated in degrees with zero at true north. The inner circle indicates magnetic north.

On many NGA charts magnetic variation is given to the nearest 1' by notes in the centers of compass roses. the annual change is given to the nearest 1' to permit correction of the given value at a later date. On NOS charts, variation is to the nearest 15', updated at each new edition if over

three years old. The current practice of NGA is to give the magnetic variation to the nearest 1', but the magnetic information on new editions is only updated to conform with the latest five year epoch. Whenever a chart is reprinted, the magnetic information is updated to the latest epoch. On some smaller scale charts, the variation is given by isogonic lines connecting points of equal variation; usually a separate line represents each degree of variation. The line of zero variation is called the agonic line. Many plans and insets show neither compass roses nor isogonic lines, but indicate magnetic information by note. A local magnetic disturbance of sufficient force to cause noticeable deflection of the magnetic compass, called local attraction, is indicated by a note on the chart.

Currents are sometimes shown on charts with arrows giving the directions and figures showing speeds. The information refers to the usual or average conditions. According to tides and weather, conditions at any given

time may differ considerably from those shown.

Review chart notes carefully because they provide important information. Several types of notes are used. Those in the margin give such information as chart number, publication notes, and identification of adjoining charts. Notes in connection with the chart title include information on scale, sources of data, tidal information, soundings, and cautions. Another class of notes covers such topics as local magnetic disturbance, controlling depths of channels, hazards to navigation, and anchorages.

A datum note will show the geodetic datum of the chart

(Do not confuse with the sounding datum. See Chapter 2 - Geodesy and Datums in Navigation). It may also contain instructions on plotting positions from the WGS 84 or NAD 83 datums on the chart if such a conversion is needed.

Anchorage areas are labeled with a variety of magenta, black, or green lines depending on the status of the area. Anchorage berths are shown as purple circles, with the number or letter assigned to the berth inscribed within the circle. Caution notes are sometimes shown when there are specific anchoring regulations.

Spoil areas are shown within short broken black lines. Spoil

NANTUCKET HARBOR							
Tabulated from surveys by the Corps of Engineers - report of June 1972 and surveys of Nov. 1971							
Controlling depths in channels entering from seaward in feet at Mean Low Water					Project Dimensions		
Name of Channel	Left outside quarter	Middle half of channel	Right outside quarter	Date of Survey	Width (feet)	Length (naut. miles)	Depth M. L. W. (feet)
Entrance Channel	11.1	15.0	15.0	11 - 71	300	1.2	15

Note.-The Corps of Engineers should be consulted for changing conditions subsequent to the above.

Figure 442b. Tabulations of controlling depths.

areas are tinted blue on NOS charts and labeled. These areas contain no soundings and should be avoided.

Firing and bombing practice areas in the United States territorial and adjacent waters are shown on NOS and NGA charts of the same area and comparable scale.

Danger areas established for short periods of time are not charted but are announced locally. Most military commands charged with supervision of gunnery and missile firing areas promulgate a weekly schedule listing activated danger areas. This schedule is subjected to frequent change; the mariner should always ensure they have the latest schedule prior to proceeding into a gunnery or missile firing area. Danger areas in effect for longer periods are published in the *Notice to Mariners*. Any aid to navigation established to

mark a danger area or a fixed or floating target is shown on charts.

Traffic separation schemes are shown on standard nautical charts of scale 1:600,000 and larger and are printed in magenta.

A logarithmic time-speed-distance nomogram with an explanation of its application is shown on harbor charts.

Tidal information boxes are shown on charts of scales 1:200,000 and larger for NOS charts, and various scales on NGA charts, according to the source. See Figure 442a.

Tabulations of controlling depths are shown on some NOS harbor and coastal charts. See Figure 442b.

Study *Chart No. 1* thoroughly to become familiar with all the symbols used to depict the wide variety of features on nautical charts.

REPRODUCTIONS OF FOREIGN CHARTS

443. Modified Facsimiles

Modified facsimile charts are modified reproductions of foreign charts produced in accordance with bilateral international agreements. These reproductions provide the mariner with up-to-date charts of foreign waters. Modified facsimile charts published by NGA are, in general, reproduced with minimal changes, as listed below:

1. The original name of the chart may be removed and replaced by an anglicized version.
2. English language equivalents of names and terms

on the original chart are printed in a suitable glossary on the reproduction, as appropriate.

3. All hydrographic information, except bottom characteristics, is shown as depicted on the original chart.
4. Bottom characteristics are as depicted in *Chart No. 1*, or as on the original with a glossary.
5. The unit of measurement used for soundings is shown in block letters outside the upper and lower neatlines.
6. A scale for converting charted depth to feet, meters, or fathoms is added.
7. Blue tint is shown from a significant depth curve to

- the shoreline.
8. Blue tint is added to all dangers enclosed by a dotted danger curve, dangerous wrecks, foul areas, obstructions, rocks awash, sunken rocks, and swept wrecks.
 9. Caution notes are shown in purple and enclosed in a box.
 10. Restricted, danger, and prohibited areas are usually

- outlined in purple and labeled appropriately.
11. Traffic separation schemes are shown in purple.
12. A note on traffic separation schemes, printed in black, is added to the chart.
13. Wire dragged (swept) areas are shown in purple or green.
14. Corrections are provided to shift the horizontal datum to the WGS (1984).

INTERNATIONAL CHARTS

444. International Chart Standards

The need for mariners and chart makers to understand and use nautical charts of different nations became increasingly apparent as the maritime nations of the world developed their own establishments for the compilation and publication of nautical charts from hydrographic surveys. Representatives of twenty-two nations formed a Hydrographic Conference in London in 1919. That conference resulted in the establishment of the **International Hydrographic Bureau (IHB)** in Monaco in 1921. Today, the IHB's successor, the **International Hydrographic Organization (IHO)** continues to provide international standards for the cartographers of its member nations. (See Chapter 1 - Introduction to Marine Navigation, for a description of the IHO.)

Recognizing the considerable duplication of effort by member states, the IHO in 1967 moved to introduce the first **international chart**. It formed a committee of six member states to formulate specifications for two series of international charts. Eighty-three small-scale charts were approved; responsibility for compiling these charts has subsequently been accepted by the member states' Hydrographic Offices.

Once a Member State publishes an international chart, reproduction material is made available to any other Member State which may wish to print the chart for its own purposes.

International charts can be identified by the letters INT before the chart number and the IHO seal in addition to other national seals which may appear.

PRINT ON DEMAND CHARTS

445. NOAA Print-on-Demand Paper Charts

NOAA's paper nautical charts are available as "print-on-demand," up-to-date to the time of purchase. Coast Survey reviews charts weekly, and applies all critical corrections specified in Notices to Mariners. NOAA print-on-demand paper charts must be printed by NOAA-certified agents to meet the requirements for the mandatory carriage of nautical charts.



Figure 445. NOAA Print-on-Demand charts.

<https://www.nauticalcharts.noaa.gov/pod/index.html>

446. NOAA PDF Nautical Charts

NOAA provides about a thousand high-resolution printable nautical charts - almost the entire NOAA suite of

charts - as PDF files. The PDF nautical charts are exact images of NOAA's traditional nautical charts. Coast Survey checks each chart weekly, and applies all critical corrections. Most charts can be printed from any plotter capable of plotting 36" width to achieve 1:1 scale. (NOTE: Mariners using paper charts to meet chart carriage requirements under federal regulations should use printed charts provided by NOAA-certified print-on-demand vendors).



Figure 446. NOAA PDF charts.

<https://www.nauticalcharts.noaa.gov/pdfcharts/>

447. NGA Enterprise Print on Demand Service (ePODs)

The Enterprise Print on Demand Service (ePODs) is NGA's effort to expedite and modernize the creation of leg-

acy chart formats based on geospatially enabled database information. ePODs is a revolutionary concept that utilizes evolutionary methods to provide hardcopy charts built from digital data to the customer. ePODs are print-ready nautical chart files generated directly from existing vector data sets

of foundation feature data. The system produces print-ready files that can be delivered directly to DoD and other authorized customers, or stored at a Remote Replication Service (RSS) sites for printing products “on demand.”

CHART NUMBERING

448. The Chart Numbering System

NGA and NOS use a system in which numbers are assigned in accordance with both the scale and geographical area of coverage of a chart. With the exception of certain charts produced for military use only, one- to five-digit numbers are used. With the exception of one-digit numbers, the first digit identifies the area; the number of digits establishes the scale range. The one-digit numbers are used for certain products in the chart system

which are not actually charts.

<i>Number of Digits</i>	<i>Scale</i>
1	No Scale
2	1:9 million and smaller
3	1:2 million to 1:9 million
4	Special Purpose
5	1:2 million and larger

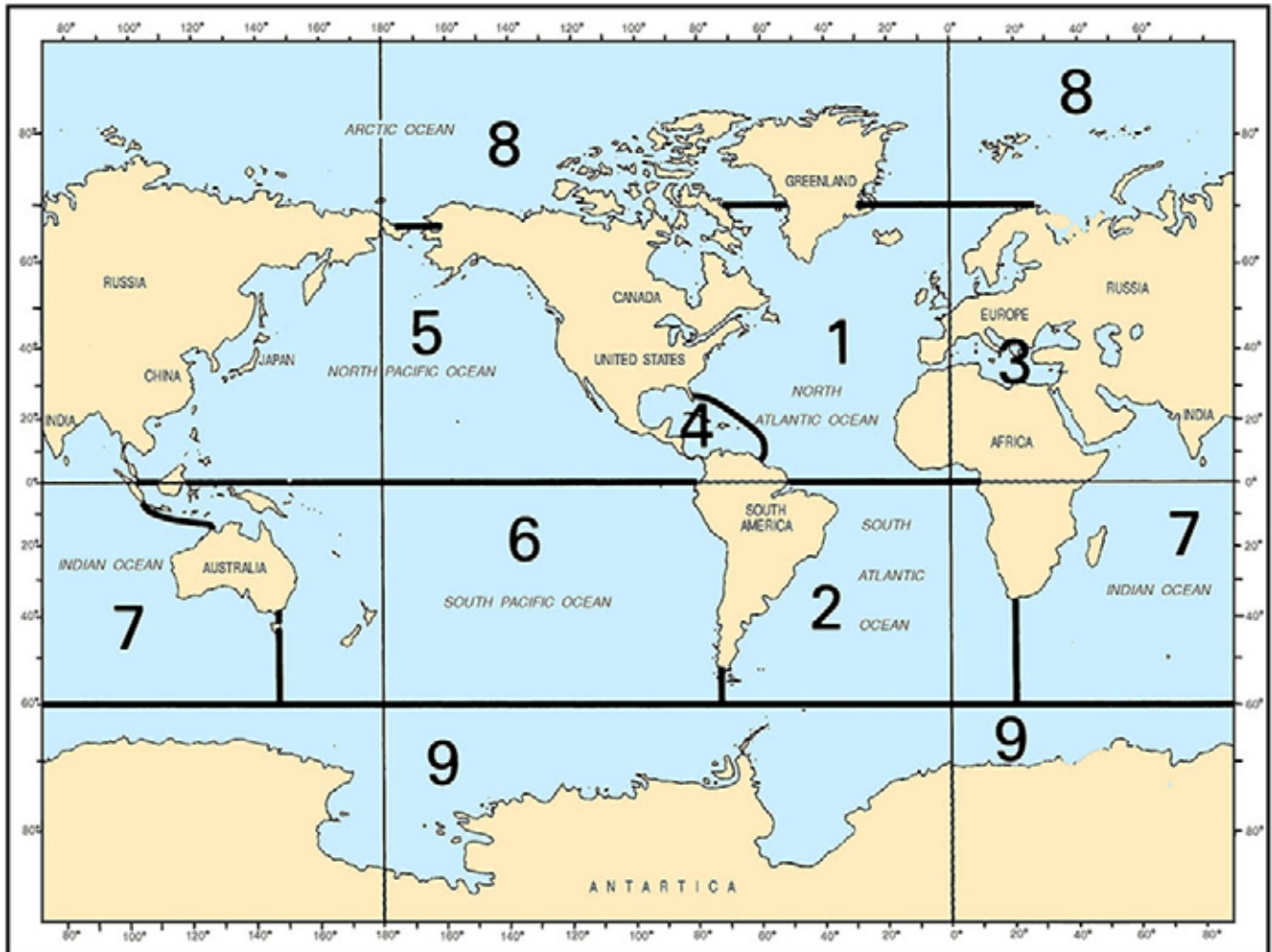

Figure 448a. Ocean basins with region numbers.

Two- and three-digit numbers are assigned to those small-scale charts which depict a major portion of an ocean basin or a large area. The first digit identifies the applicable ocean basin. See Figure 448a. Two-digit numbers are used for charts of scale 1:9,000,000 and smaller. Three-digit numbers are used for charts of scale 1:2,000,000 to 1:9,000,000.

Due to the limited sizes of certain ocean basins, no charts for navigational use at scales of 1:9,000,000 and smaller are published to cover these basins. The otherwise unused two-digit numbers (30 to 49 and 70 to 79) are assigned to special world charts.

One exception to the scale range criteria for three-digit numbers is the use of three-digit numbers for a series of position plotting sheets. They are of larger scale than 1:2,000,000 because they have application in ocean basins and can be used in all longitudes.

Four-digit numbers are used for non-navigational and special purpose charts, such as chart 5090, *Maneuvering Board*.

Five-digit numbers are assigned to those charts of scale 1:2,000,000 and larger that cover portions of the coastline rather than significant portions of ocean basins. These charts are based on the regions of the nautical chart index. See Figure 448b.

The first of the five digits indicates the region; the second digit indicates the subregion; the last three digits indicate the geographical sequence of the chart within the subregion. Many numbers have been left unused so that any future charts may be placed in their proper geographical sequence.

In order to establish a logical numbering system within the geographical subregions (for the 1:2,000,000 and larger-scale charts), a worldwide skeleton framework of coastal charts was laid out at a scale 1:250,000. This series was used as basic coverage except in areas where a coordinated series at about this scale already existed (such as the coast of Norway where a coordinated series of 1:200,000 charts was available).

Within each region, the geographical subregions are numbered counterclockwise around the continents, and within each subregion the basic series also is numbered counterclockwise around the continents. The basic coverage is assigned generally every 20th digit, except that the first 40 numbers in each subregion are reserved for smaller-scale coverage. Charts with scales larger than the basic coverage are assigned one of the 19 numbers following the number assigned to the sheet

within which it falls. Figure 448c shows the numbering sequence in Iceland. Note the sequence of numbers around the coast, the direction of numbering, and the numbering of larger scale charts within the limits of smaller scales.

Five-digit numbers are also assigned to the charts produced by other hydrographic offices. This numbering system is applied to foreign charts so that they can be filed in logical sequence with the charts produced by the NGA and the NOS.

Certain exceptions to the standard numbering system have been made for charts intended for the military. Bottom contour charts depict parts of ocean basins. They are identified with a letter plus four digits according to a scheme best shown in the catalog, and are not available to civilian navigators. Combat charts have 6-digit numbers beginning with an "8." Neither is available to civilian navigators.

449. Catalogs and Stock Numbers

The *NGA/DLIS Catalog of Maps, Charts and Related Products* is available on CD only. It is reserved for military and government agencies, which possess access to limited distribution data. New versions of the catalog are released every six months with corrections published in the weekly *Notice to Mariners*. The standalone CD is interactive with a robust Table of Contents. The digital catalog has the ability to pan across the Pacific Ocean. Military navigators receive their nautical charts and publications automatically; civilian navigators purchase them from chart sales agents.

NOAA charts are available digitally through its *Nautical Products Catalog* or by selecting one of the five regional chart catalogs. There is also a print-at-home option for NOAA chart catalogs. By visiting the NOAA nautical charts and publications website, users can select their region of interest and download a PDF. The *Nautical Product Catalog* provides access to paper charts (RNC & PDF) as well as Electronic Charts (ENC). See Figure 449 for a link to the NOAA chart catalog.

The stock number and bar code are generally found in the lower left corner of a NGA chart. The first two digits of the stock number refer to the region and subregion. These are followed by three letters, the first of which refers to the portfolio to which the chart belongs; the second two denote the type of chart: CO for coastal, HA for harbor and approach, and OA for military operating area charts. The last five digits are the actual chart number.

INDEX OF REGIONS AND SUBREGIONS

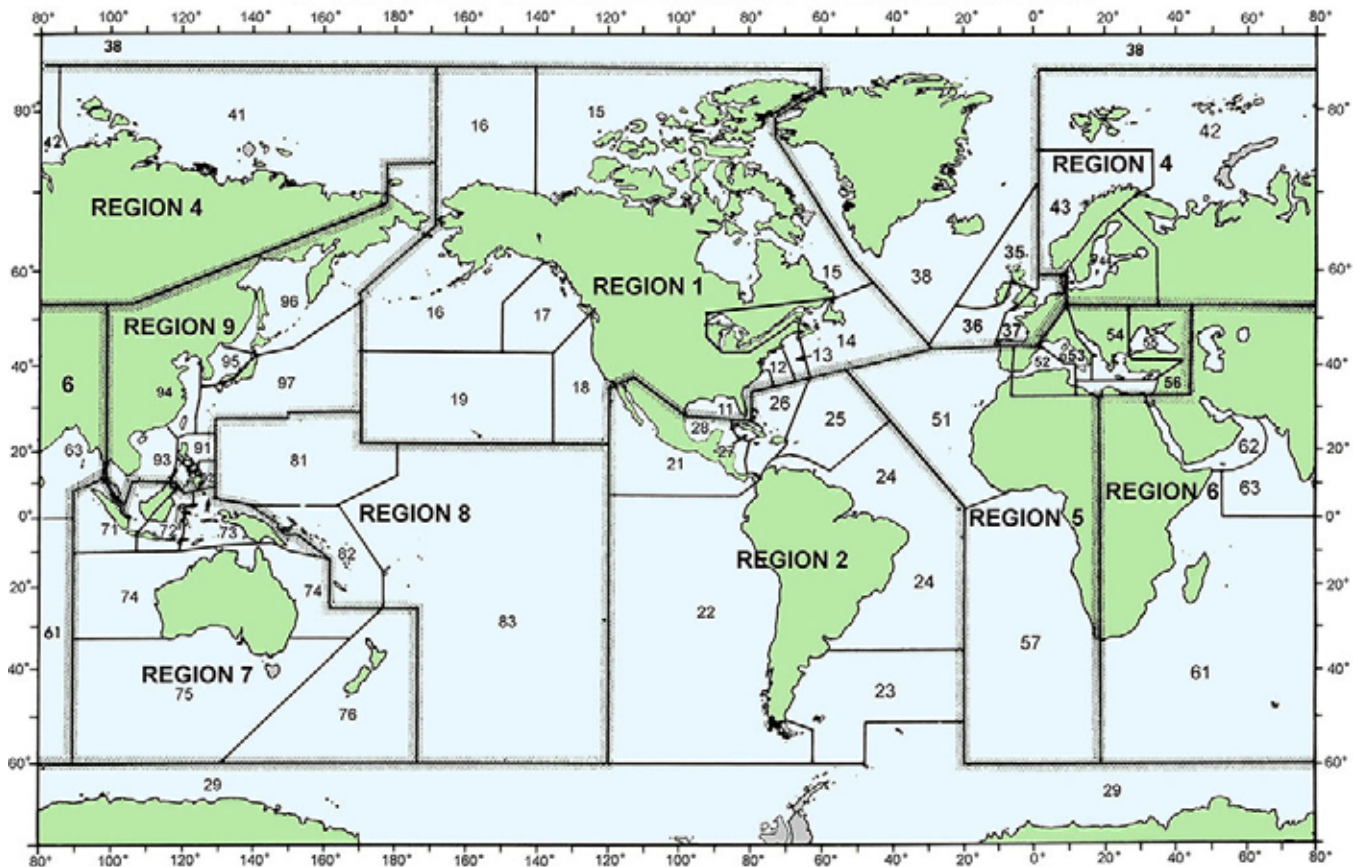

Figure 448b. Regions and subregions of the nautical chart index.

USING CHARTS

450. Preliminary Steps

Before using a new edition of a chart, verify its announcement in the *Notice to Mariners* and correct it with all applicable corrections. Read all the chart's notes; there should be no question about the meanings of symbols or the units in which depths are given. Since the latitude and longitude scales differ considerably on various charts, carefully note those on the chart to be used.

Place additional information on the chart as required. Arcs of circles might be drawn around navigational lights to indicate the limit of visibility at the height of eye of an observer on the bridge. Notes regarding other information from the light lists, tide tables, tidal current tables, and sailing directions might prove helpful.

451. Maintaining Charts

A mariner navigating on an uncorrected chart is courting disaster. The chart's print date reflects the latest *Notice to Mariners* used to update the chart; responsibility for maintaining it after this date lies with the user. The weekly *Notice*

to Mariners contains information needed for maintaining charts. Radio broadcasts give advance notice of urgent corrections. Local *Notice to Mariners* should be consulted for inshore areas. The navigator must develop a system to keep track of chart corrections and to ensure that the chart they are using is updated with the latest correction.

For vessels still using paper charts a convenient way of keeping this record is with a **Chart/Publication Correction Record Card** system. Using this system, navigators do not immediately update every chart in their portfolio when they receive the *Notice to Mariners*. Instead, they construct a card for every chart in their portfolio and notes the corrections on this card. When the time comes to use the chart, they pull the chart and the chart's card, and they makes the indicated corrections on the chart. This system ensures that every paper chart is properly corrected prior to use.

Electronic and printed chart correction card forms are available through the NGA Maritime Safety Information web portal under the miscellaneous products tab. See Figure 451 for the link.

With *Notice to Mariners* available on the internet, mari-

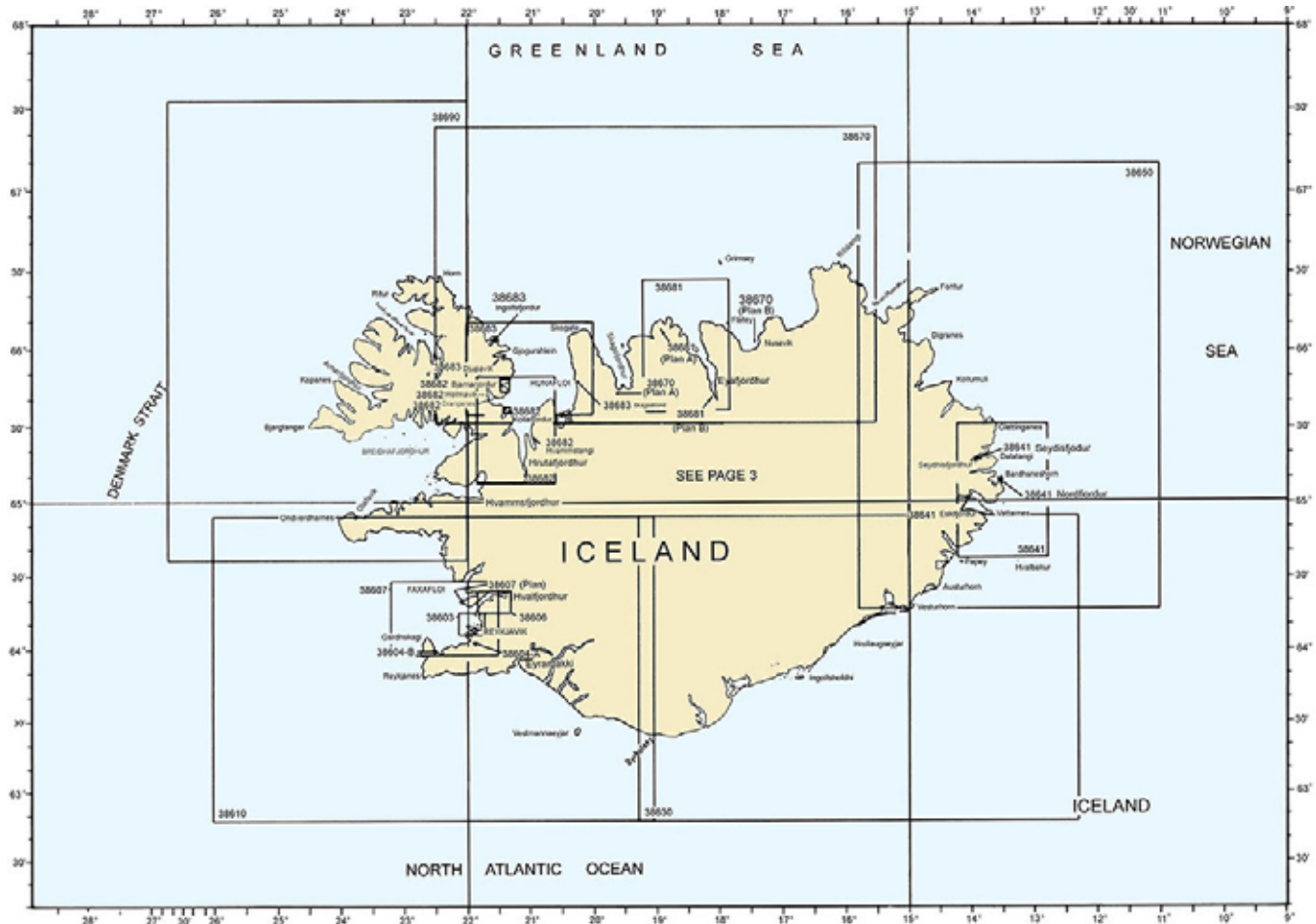

Figure 448c. Chart coverage of Iceland, illustrating the sequence and direction of the U.S. chart numbering system.



Figure 449. NOAA Nautical Chart Catalogs.

<https://www.nauticalcharts.noaa.gov/staff/charts.htm>

ners have the ability to see all applicable corrections to a chart by a specified date range, all corrections and also for multiple charts at a time. A Summary of Corrections, containing a cumulative listing of previously published *Notice to Mariners* corrections, is published annually in 5 volumes by NGA. Thus, to fully correct a chart whose edition date is several years old, the navigator needs only the *Summary of Corrections* for that region and the notices from that Summary forward; the navigator does not need to obtain notices all the way back to the edition date. See Chapter 6, Nautical



Figure 451. Chart correction forms.

https://msi.nga.mil/NGAPortal/MSI.portal?_nfpb=true&_st=&_pageLabel=msi_portal_page_69&prodCode=03

Publications, for a description of the Summaries and *Notice to Mariners*.

When a new edition of a chart is published, it is normally furnished automatically to U.S. Government vessels. It should not be used until it is announced as ready for use in the *Notice to Mariners*. Until that time, corrections in the Notice apply to the old edition and should not be applied to the new one. When it is announced, a new edition of a chart replaces an older one.

Commercial users and others who don't automatically

receive new editions should obtain new editions from their sales agent. Occasionally, charts may be received or purchased several weeks in advance of their announcement in the *Notice to Mariners*. This is usually due to extensive re-scheming of a chart region and the need to announce groups of charts together to avoid lapses in coverage. The mariner bears the responsibility for ensuring that their charts are the current edition. The fact that a new edition has been compiled and published often indicates that there have been extensive changes that cannot be made by hand corrections.

452. Using and Stowing Charts

Use and stow charts carefully. This is especially true with digital charts contained on electronic media. Keep optical and magnetic media containing chart data out of the sun, inside dust covers, and away from magnetic influences. Placing a disk in an inhospitable environment may destroy the data.

Make permanent corrections to paper charts in ink so that they will not be inadvertently erased. Pencil in all other markings so that they can be easily erased without damaging the chart. Lay out and label tracks on charts of frequently-traveled ports in ink. Draw lines and labels no larger than necessary. Do not obscure sounding data or other information when labeling a chart. When a voyage is completed, carefully erase the charts unless there has been

a grounding or collision. In this case, preserve the charts without change because they will play a critical role in the investigation.

When not in use, stow charts flat in their proper portfolio. Minimize their folding and properly index them for easy retrieval.

453. Chart Lighting

Mariners often work in a red light environment because red light is least disturbing to night adapted vision. Such lighting can significantly affect the appearance of a chart. Before using a chart in red light, test the effect red light has on its markings. Do not outline or otherwise indicate navigational hazards in red pencil because red markings disappear under red light.

454. Port Maury Sample Chart

U.S. Chart No. 9999 - Port Maury (Wilkes Island, North Pacific) is produced by NGA and NOAA for training purposes. This fictitious sample of a nautical chart depicts a typical harbor area. The chart symbology is annotated to include references to U.S. Chart No. 1 and is meant to be a beginners guide and teaching reference to students of marine navigation.

SOUNDINGS IN METERS

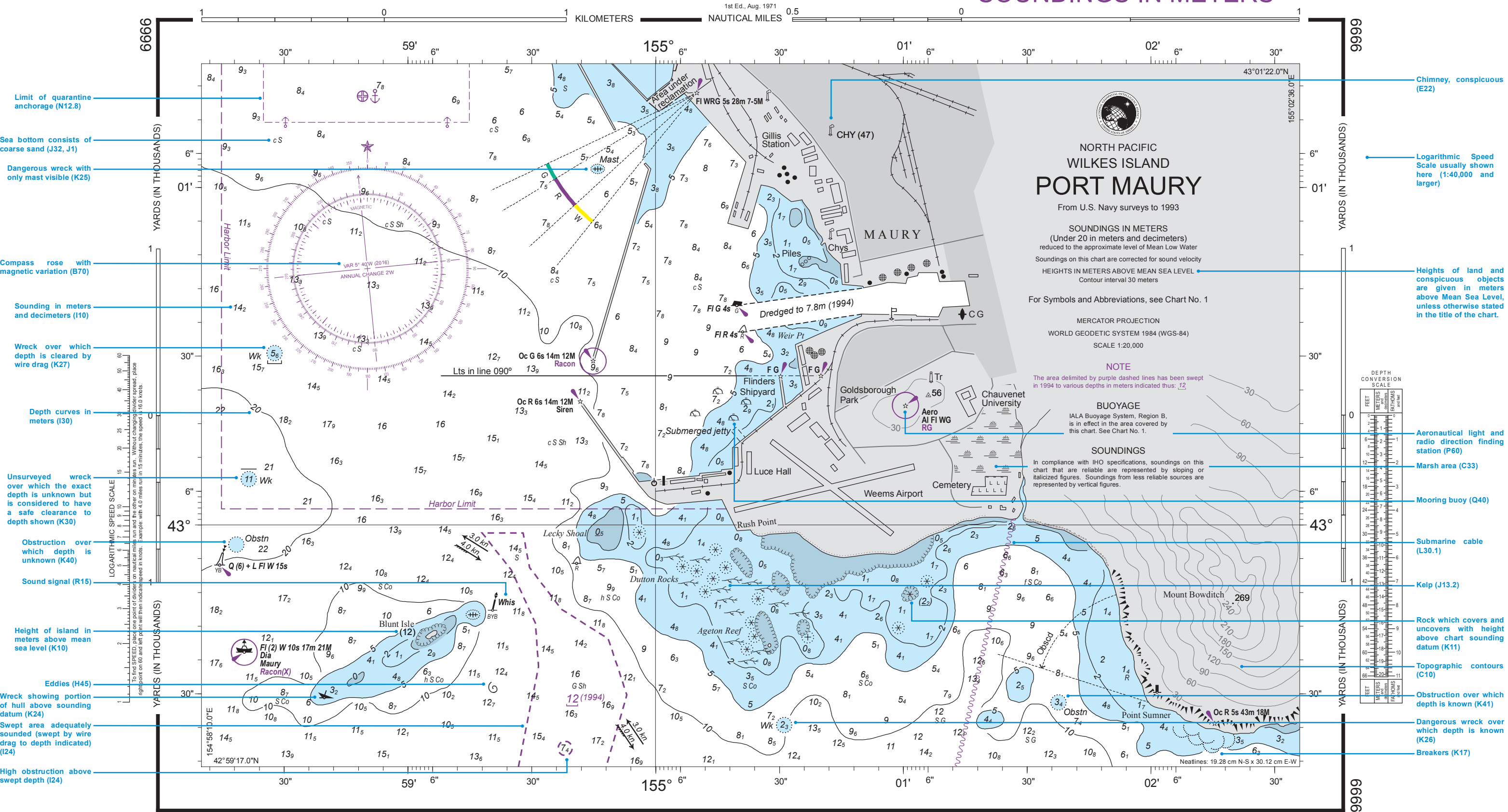

- Limit of quarantine anchorage (N12.8)
- Sea bottom consists of coarse sand (J32, J1)
- Dangerous wreck with only mast visible (K25)
- Compass rose with magnetic variation (B70)
- Sounding in meters and decimeters (I10)
- Wreck over which depth is cleared by wire drag (K27)
- Depth curves in meters (I30)
- Unsurveyed wreck over which the exact depth is unknown but is considered to have a safe clearance to depth shown (K30)
- Obstruction over which depth is unknown (K40)
- Sound signal (R15)
- Height of island in meters above mean sea level (K10)
- Eddies (H45)
- Wreck showing portion of hull above sounding datum (K24)
- Swept area adequately sounded (swept by wire drag to depth indicated) (I24)
- High obstruction above swept depth (I24)

- Chimney, conspicuous (E22)
- Logarithmic Speed Scale usually shown here (1:40,000 and larger)
- Heights of land and conspicuous objects are given in meters above Mean Sea Level, unless otherwise stated in the title of the chart.
- Aeronautical light and radio direction finding station (P60)
- Marsh area (C33)
- Mooring buoy (Q40)
- Submarine cable (L30.1)
- Kelp (J13.2)
- Rock which covers and uncovers with height above chart sounding datum (K11)
- Topographic contours (C10)
- Obstruction over which depth is known (K41)
- Dangerous wreck over which depth is known (K26)
- Breakers (K17)

8th Ed., Sept. 3, 2016 (Correct through NM 36/16)
9999
NSN 7642019999999
NGA Ref No. W0XZC9999

SOUNDINGS IN METERS

Prepared and published by the
NATIONAL GEOSPATIAL-INTELLIGENCE AGENCY
© Copyright 2016 by the United States Government

WARNING
The prudent mariner will not rely solely on any single aid to navigation, particularly on floating aids. See paragraph No. 1 of Notice to Mariners No. 1 or Sailing Directions Planning Guides for information relative to NGA Charts.

Port Maury
SOUNDINGS IN METERS - SCALE 1:20,000

USERS SHOULD REFER CORRECTIONS, ADDITIONS, AND COMMENTS TO NGA'S MARITIME OPERATIONS DESK; TOLL FREE: 1-800-362-6289; COMMERCIAL: 571-557-5455; DSN: 547-5455. SEND EMAIL TO NAVSAFETY@NGA.MIL; USE CONTACT LINKS FOR DNC AND MARITIME WEBSITES LOCATED AT <http://msi.nga.mil/NGAPortMaury.html>; OR WRITE TO OFFICE OF MARITIME SAFETY, NATIONAL GEOSPATIAL-INTELLIGENCE AGENCY, MAIL STOP N65, 7500 GEORGE DRIVE, SPRINGFIELD VA 22150-7500.

References to U.S. Chart No. 1 are shown in parentheses.

NOAA encourages users to submit inquiries discrepancies or comments about this chart at <http://www.nauticalcharts.noaa.gov/staff/contact.htm>.

SOUNDINGS IN FATHOMS

(FATHOMS & FEET TO 11 FATHOMS)

Formerly C&GS 4196, 1st Ed., Aug. 1971

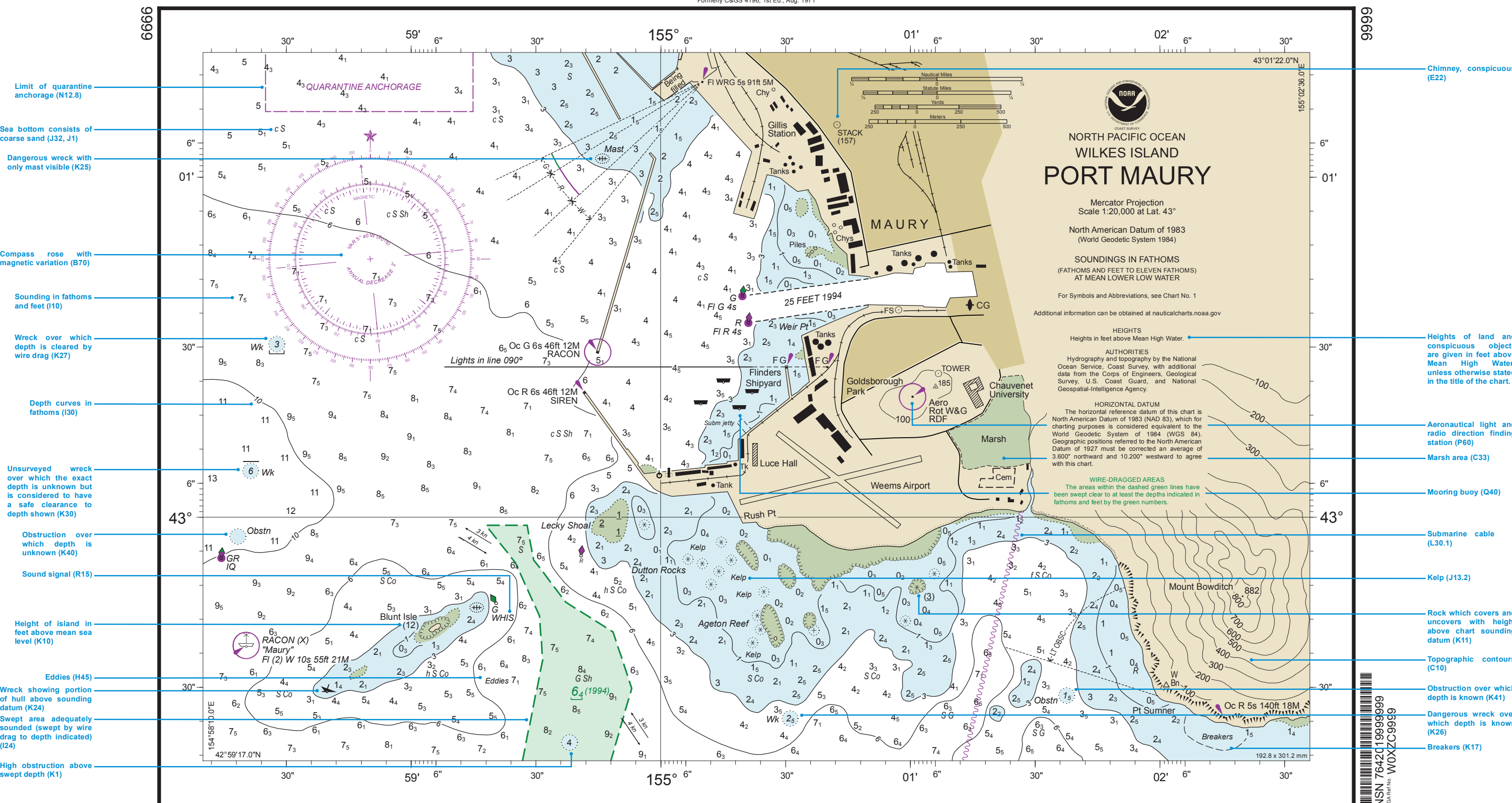

- Limit of quarantine anchorage (N12.8)
- Sea bottom consists of coarse sand (J32, J1)
- Dangerous wreck with only mast visible (K25)
- Compass rose with magnetic variation (B70)
- Sounding in fathoms and feet (I10)
- Wreck over which depth is cleared by wire drag (K27)
- Depth curves in fathoms (I30)
- Unsurveyed wreck over which the exact depth is unknown but is considered to have a safe clearance to depth shown (K30)
- Obstruction over which depth is unknown (K40)
- Sound signal (R15)
- Height of island in feet above mean sea level (K10)
- Eddies (H45)
- Wreck showing portion of hull above sounding datum (K24)
- Swept area adequately sounded (swept by wire drag to depth indicated) (I24)
- High obstruction above swept depth (K1)

- Chimney, conspicuous (E22)
- Heights of land and conspicuous objects are given in feet above Mean High Water, unless otherwise stated in the title of the chart.
- Aeronautical light and radio direction finding station (P60)
- Marsh area (C33)
- Mooring buoy (Q40)
- Submarine cable (L30.1)
- Kelp (J13.2)
- Rock which covers and uncovers with height above chart sounding datum (K11)
- Topographic contours (C10)
- Obstruction over which depth is known (K41)
- Dangerous wreck over which depth is known (K26)
- Breakers (K17)

8th Ed., Sep. 2016
 9999
 Last Correction: 9/3/2016. Cleared through:
 LNM: , NM: 3616 (9/3/2016)

References to U.S. Chart No. 1 are shown in parentheses.

CAUTION
 This chart has been corrected from the Notice to Mariners (NM) published weekly by the National Geospatial-Intelligence Agency and the Local Notice to Mariners (LNM) issued periodically by each U.S. Coast Guard district to the dates shown in the lower left hand corner. Chart updates corrected from Notice to Mariners published after the dates shown in the lower left hand corner are available at nauticalcharts.noaa.gov.

Published at Washington, D.C.
 U.S. DEPARTMENT OF COMMERCE
 NATIONAL OCEANIC AND ATMOSPHERIC ADMINISTRATION
 NATIONAL OCEAN SERVICE
 COAST SURVEY

WARNING
 The prudent mariner will not rely solely on any single aid to navigation, particularly on floating aids. See U.S. Coast Guard Light List and U.S. Coast Pilot for details.

Port Maury
 SOUNDINGS IN FATHOMS - SCALE 1:20,000

FATHOMS	1	2	3	4	5	6	7	8	9	10	11	12	13	14	15	16	17
FEET	6	12	18	24	30	36	42	48	54	60	66	72	78	84	90	96	102
METERS	1	2	3	4	5	6	7	8	9	10	11	12	13	14	15	16	17

NSN 7642019999999
 NGA Ref No. W0XZC9999

CHAPTER 5

ECDIS

ELECTRONIC CHART DISPLAY AND INFORMATION SYSTEMS

500. The Importance of Electronic Charts

From the very beginning of the human quest to travel by water, the core desire of the navigator has always been to answer the fundamental question, “Where, exactly, is my vessel?” As navigators labored to answer this question through the ages, increasingly more sophisticated fix positioning methods were developed. Techniques matured from the simple use of plotting by visually observing objects ashore, to understanding how to mathematically translate the observed altitudes of celestial bodies, and eventually fix in a position using radio and satellite signals. Regardless the method, until the development of electronic charting technologies, the end result was always the same: calculate latitude and longitude, then plot the vessel’s position on a paper chart. Only then could they begin to assess the safety of the ship and its progress toward its destination. Far more time was spent taking fixes, working out solutions, and plotting the results than on making assessments; and the fix only indicated where the ship was at the time the fix was taken, not where the vessel was in real time. The navigator was always “behind the vessel.” On the high seas this may be of little importance, but near shore, it becomes vitally essential.

Electronic charts automate the process of integrating real-time positions with the chart display and allow the navigator to continuously assess the position and safety of the vessel. Further, the GPS/DGPS fixes are far more accurate and taken far more often than any navigator ever could using manual methods. A good piloting team is expected to take and plot a fix every three minutes. An electronic chart system can do it once per second to a standard of accuracy at least an order of magnitude better.

An Electronic Chart Display and Information System (ECDIS) allows the integration of other operational data, such as ship’s course and speed, depth soundings, automatic identification systems (AIS) information, and radar data into the display. Further, ECDIS allows automation of alarm systems to alert the navigator to potentially dangerous situations. Navigation with an ECDIS can also provide enhanced situational awareness of important events.

Finally, the navigator has a complete instantaneous picture of the instantaneous situation of the vessel and all charted dangers in the area. With a radar overlay, the tactical situation with respect to other vessels is clear as

well. This chapter will discuss the various types of electronic charts, the requirements for using them, and their characteristics, capabilities and limitations.

501. Terminology

Before understanding what an electronic chart is and what it does, one must learn a number of terms and definitions. We must first make a distinction between official and unofficial charts. Official charts are those, and only those, issued officially by, or on the authority of, a Government authorized Hydrographic Office (HO), or other relevant government institution, and are designed to meet the requirements of marine navigation. Unofficial charts are produced by a variety of private companies and may or may not meet the same standards used by HOs for data accuracy, currency, and completeness.

An **electronic chart system (ECS)** is a computer assisted navigation system capable of displaying electronic nautical charts and the vessel’s position in near real time. An ECS does not meet all the input, display and functionality of an Electronic Chart Display and Information System.

An **electronic chart display and information system (ECDIS)** is a navigation information system which with adequate back-up arrangements can be accepted as complying with the up-to-date chart required by the 1974 SOLAS Convention, by displaying selected information from a system electronic navigational chart (SENC) with positional information from navigation sensors to assist the mariner in route planning and route monitoring, and if required display additional navigation-related information.

An **electronic chart (EC)** is any digitized chart intended for display on a computerized navigation system.

An **electronic chart data base (ECDB)** is the digital database from which electronic charts are produced.

An **electronic navigational chart (ENC)** is the database, standardized as to content, structure and format, issued for use with ECDIS on the authority of government authorized hydrographic offices. The ENC contains all the chart information necessary for safe navigation and may contain supplementary information in addition to that contained in the paper chart (e.g. sailing directions) which may be considered necessary for safe navigation.

The **system electronic navigation chart (SENC)** means a database resulting from the transformation of the

ENC by ECDIS for appropriate use, updates to the ENC by appropriate means and other data added by the mariner. It is this database that is actually accessed by ECDIS for the display generation and other navigational functions, and is the equivalent to an up-to-date paper chart. The SENC may also contain information from other sources.

A **raster navigation chart (RNC)** is a raster-formatted chart produced by a national hydrographic office.

A **raster chart display system (RCDS)** is a system which displays official raster-formatted charts on an ECDIS system. Raster charts cannot take the place of paper charts because they lack key features required by the IMO, so that when an ECDIS uses raster charts it operates in the ECS mode.

Overscale and **underscale** refer to the display of electronic chart data at too large and too small a scale, respectively. In the case of overscale, the display is “zoomed in” too close, beyond the standard of accuracy to which the data was digitized. Underscale indicates that larger scale data is available for the area in question. ECDIS provides a warning in either case.

Raster chart data is a digitized image of a chart comprised of millions of pixels. All data is in one layer and one format. The video display simply reproduces the picture from its digitized data file. With raster data, it is difficult to change individual elements of the chart since they are not separated in the data file. Raster data files tend to be large, since a data point with associated color and intensity values must be entered for every pixel on the chart.

Vector chart data is data that is organized into many separate files or layers. It contains graphics files and programs to produce certain symbols, points, lines, and areas with associated colors, text, and other chart elements. The navigator can selectively display vector data, adjusting the display according to voyage needs. Vector data supports the computation of precise distances between features and can provide warnings when hazardous situations arise.

502. Components of ECS and ECDIS

The terms ECS and ECDIS encompasses many possible combinations of equipment and software designed for a variety of navigational purposes. In general, the following components comprise an ECS or ECDIS.

- **Computer processor, software, and network:** These subsystems control the processing of information from the vessel's navigation sensors and the flow of information between various system components. Electronic positioning information from GPS or DGPS, contact information from radar, and digital compass data, for example, can be integrated with the electronic chart data.

- **Chart database:** At the heart of any ECS lies a database of digital charts. It is this dataset, or a portion of it, that produces the chart seen on the display screen.

- **System display:** This unit displays the electronic chart and indicates the vessel's position on it, and provides other information such as heading, speed, distance to the next waypoint or destination, soundings, etc. There are two modes of display, **relative** and **true**. In the relative mode the ship remains fixed in the center of the screen and the chart moves past it. This requires a lot of computer power, as all the screen data must be updated and re-drawn at each fix. In true mode, the chart remains fixed and the ship moves across it. The display may also be north-up or course-up, according to the availability of data from a heading sensor such as a digital compass.

- **User interface:** This is the user's link to the system. It allows the navigator to change system parameters, enter data, control the display, and operate the various functions of the system. Radar may be integrated with the ECDIS or ECS for navigation or collision avoidance, but is not required by SOLAS regulations.

503. Legal Aspects of Using Electronic Charts

Requirements for carriage of charts are found in SOLAS Chapter V, which states in part: “All ships shall carry adequate and up-to-date charts... necessary for the intended voyage.” As electronic charts have developed and the supporting technology has matured, regulations have been adopted internationally to set standards for what constitutes a “chart” in the electronic sense, and under what conditions such a chart will satisfy the chart carriage requirement.



Figure 503. USCG (NVIC 01-16) - Use of Electronic Charts and Publications in Lieu of Paper Charts, Maps and Publications.

https://www.uscg.mil/hq/cg5/nvic/pdf/2016/NVIC_01-16_electronic_charts_and_publications.pdf

An extensive body of rules and regulations controls the production of ECDIS equipment, which must meet certain high standards of reliability and performance. Only those systems identified by the U.S. Coast Guard can relieve the navigator of the responsibility of maintaining a corrected paper chart. Certain U.S. flagged vessels are subject to do-

mestic chart and publication carriage requirements codified in Titles 33 and 46 of the Code of Federal Regulations (C.F.R.). In February 2016, the U.S. Coast Guard issued Navigation and Vessel Inspection Circular (NVIC) 01-16, which states SOLAS-compliant equipment, three specific Radio Technical Commission for Maritime Services (RT-CM) classes of ECS, and certain publications, will be accepted as the equivalent of the requirements described in the aforementioned C.F.R.s. NVIC 01-16 can be found at the link provided in Figure 503.

The presence of an electronic chart system is not, how-

ever, a substitute for good judgment, sea sense, and taking all reasonable precautions to ensure the safety of the vessel and crew.

An electronic chart system should be considered a navigational aid, one of many navigators might have at their disposal to help ensure a safe passage. While possessing revolutionary capabilities, it must be considered as a tool, not an infallible answer to all navigational problems. The rule for the use of electronic charts is the same as for all other navigational aids: The prudent navigator will never rely completely on any single one.

CAPABILITIES AND PERFORMANCE STANDARDS

504. ECDIS Performance Standards

The specifications for ECDIS consist of a set of inter-related standards from three organizations, the International Maritime Organization (IMO), the International Hydrographic Organization (IHO), and the International Electrotechnical Commission (IEC). The IMO published a resolution in November 1995 to establish performance standards for the general functionality of ECDIS, and to define the conditions for its replacement of paper charts. It consisted of a 15-section annex and 5 original appendices. Appendix 6 was adopted in 1996 to define the backup requirements for ECDIS. Appendix 7 was adopted in 1998 to define the operation of ECDIS in a raster chart mode. Previous standards related only to vector data.

The IMO performance standards refer to IHO Special Publication S-52 for specification of technical details pertaining to the ECDIS display. Produced in 2014, the 6th edition of S-52 includes appendices includes the Presentation Library and specifies updating, display, color, and symbology of official electronic navigational charts (ENC), as well as a revised glossary of ECDIS-related terms. The IMO performance standards also refer to IEC International Standard 61174 for the requirements of type approval of an ECDIS. Published in 1998, the IEC standard defines the testing methods and required results for an ECDIS to be certified as compliant with IMO standards. Accordingly, the first ECDIS was given type approval by Germany's classification society (BSH) in 1999. Since then, multiple other makes of ECDIS have gained type approval by various classification societies.

The IMO performance standards specify the following general requirements: Display of government-authorized vector chart data including an updating capability; enable route planning, route monitoring, manual positioning, and continuous plotting of the ship's position; have a presentation as reliable and available as an official paper chart; provide appropriate alarms or indications regarding displayed information or malfunctions; and permit a mode of operation with raster charts similar to the above standards.

The performance standards also specify additional functions, summarized as follows:

- Display of system information in three selectable levels of detail
- Means to ensure correct loading of ENC data and updates
- Apply updates automatically to system display
- Protect chart data from any alteration
- Permit display of update content
- Store updates separately and keep records of application in system
- Indicate when user zooms too far in or out on a chart (over- or under-scale) or when a larger scale chart is available in memory
- Permit the overlay of radar image and ARPA information onto the display
- Require north-up orientation and true motion mode, but permit other combinations
- Use IHO-specified resolution, colors and symbols
- Use IEC-specified navigational elements and parameters (range & bearing marker, position fix, own ship's track and vector, waypoint, tidal information, etc.)
- Use specified size of symbols, letters and figures at scale specified in chart data
- Permit display of ship as symbol or in true scale
- Display route planning and other tasks
- Display route monitoring
- Permit display to be clearly viewed by more than one user in day or night conditions
- Permit route planning in straight and curved segments and adjustment of waypoints
- Display a route plan in addition to the route selected for monitoring
- Permit track limit selection and display an indication if track limit crosses a safety contour or a selected prohibited area
- Permit display of an area away from ship while

continuing to monitor selected route

- Give an alarm at a selectable time prior to ship crossing a selected safety contour or prohibited area
- Plot ship's position using a continuous positioning system with an accuracy consistent with the requirements of safe navigation
- Identify selectable discrepancy between primary and secondary positioning system
- Provide an alarm when positioning system input is lost
- Provide an alarm when positioning system and chart are based on different geodetic datums
- Store and provide for replay the elements necessary to reconstruct navigation and verify chart data in use during previous 12 hours
- Record the track for entire voyage with at least four hour time marks
- Permit accurate drawing of ranges and bearings not limited by display resolution
- Require system connection to continuous position-fixing, heading and speed information
- Neither degrade nor be degraded by connection to other sensors
- Conduct on-board tests of major functions with alarm or indication of malfunction
- Permit normal functions on emergency power circuit
- Permit power interruptions of up to 45 seconds without system failure or need to reboot
- Enable takeover by backup unit to continue navigation if master unit fails,

Before an IMO-compliant ECDIS can replace paper charts on vessels governed by SOLAS regulations, the route of the intended voyage must be covered completely by ENC data, that ENC data must include the latest updates, the ECDIS installation must be IMO-compliant including the master-slave network with full sensor feed to both units, and the national authority of the transited waters must allow for paperless navigation through published regulations. Certified training in the operational use of ECDIS is required as per STCW 2010 when an ECDIS is installed. The U.S. Coast Guard also requires training for ECS-A in U.S. waters. Certification may include alternate forms of the same ECDIS family, such as Multifunction Display, chart administration and route planning application, electronic logbook functionality, radar overlay functionality, VDR via Ethernet, and AIS keyboard plus display function.

The certifying agency issues a certificate valid for five years. For renewal, a survey is conducted to ensure that systems, software versions, components and materials used comply with type-approved documents and to review pos-

sible changes in design of systems, software versions, components, materials performance, and make sure that such changes do not affect the type approval granted.

Manufacturers have been willing to provide type-approved ECDIS to vessel operators, but in a non-compliant installation. Without the geographical coverage of ENC data, the expensive dual-network installation required by ECDIS will not eliminate the requirement to carry a corrected portfolio of paper charts. These partial installations range from approved ECDIS software in a single PC, to ECDIS with its IEC-approved hardware. In these instances, plotting on paper charts continues to be the primary means of navigation. NOAA has been providing an ENC data sets for all US waters since 2014; NGA supplies ENC data sets where NGA is the prime charting authority (See Section 517). In June 2009, IMO SOLAS Chapter V was approved and states ships engaged in international voyages must be fitted with ECDIS by July 2018. This is driving the need for readily available ENCs worldwide. As governments regulate paperless transits, vessel operators are upgrading their installations to meet full IMO compliance, making ECDIS the primary means of navigation.

505. ECS Standards

Although the IMO has declined to issue guidelines on ECS, in the United States the Radio Technical Commission for Maritime Services (RTCM) developed a voluntary, industry-wide standard for ECS. At the time of publication, the RTCM Standard recognized three classes of ECS that have varying levels of navigation functionality. This construct provided greater flexibility for manufacturers and provided the U.S. Coast Guard with the opportunity to allow an ECS, which meets the RTCM standard, to replace the paper charts (Navigation and Vessel Inspection Circular 01-16). The RTCM ECS standard follows the international standards for either raster or vector data display, and includes the requirement for simple and reliable updating of information, or an indication that the electronic chart information has changed. The three classes of ECS recognized by the U.S. Coast Guard are described in Table 505.

The term ECS, however, includes a multitude of systems, including highly complex charting systems that display vector charts issued by an authorized hydrographic office on an environmentally hardened box, to a software system displaying propriety charts on a user-selected hardware. Those ECS not adhering to the RTCM standard identified by U.S. Coast Guard policy to replace paper charts must be considered a navigational aid, and should always be used with a corrected chart from a government authorized hydrographic office.

Some classes of RTCM ECS do not meet the performance standards of either ECDIS or RCDS. But an ECDIS can operate in ECS mode when using raster charts or when using unofficial vector charts. When a type-approved ECDIS is installed without being networked to a backup

USCG Recognized Classes of Electronic Chart Systems		
Class	Description/Purpose	Training
A	System is very similar to full ECDIS but does not meet full requirements. With required equipment interface (e.g. position fixing system, AIS, heading device, etc.), it can be primary means of navigation for non-SOLAS vessels.	Watch stander must have successful completion certificate from Coast Guard approved ECDIS course and endorsement on MMC.
B	Typically has less functionality than ECS 'A.' With required equipment interface (e.g. position fixing system, AIS, heading device, etc.), it can be primary means of navigation for non-SOLAS vessels operating within 12NM of territorial sea baseline.	Familiar with system prior to assuming watch duties.
C	Primarily designed as navigational aid to plot and monitor vessels position. With required equipment interface (e.g. position fixing system, AIS, heading device, etc.), it can be primary means of navigation for non-SOLAS vessels operating within 12NM of territorial sea baseline.	Familiar with system prior to assuming watch duties.

Table 505. RTCM ECS class type and description.

ECDIS, or when it is using unofficial ENC data, or ENC data without updates, it can be said to be operating in an ECS mode. In this configuration, the system cannot be substituted for official, corrected paper charts.

506. Display Characteristics

While manufacturers of electronic chart systems have designed their own proprietary colors and symbols, the IMO Performance Standard requires that all IMO approved ECDIS and some RTCM ECS follow the International Hydrographic Organization (IHO) S-52 publication, Specifications for Chart Content and Display Aspects of ECDIS. These specifications are embodied in Annex A of S-52, the ECDIS Presentation Library, most recently updated in 2014. Their development was a joint effort between Germany, Canada, and Australia during the 1990s. In order for ECDIS to enhance the safety of navigation, every detail of the display should be clearly visible, unambiguous in its meaning, and uncluttered by superfluous information. Some ECS continue to be free to develop independent of IHO control. In general, they seek to emulate the look of the traditional paper chart.

To reduce clutter, the IMO Standard lays down a permanent display base of essentials such as depths, aids to navigation, shoreline, etc., making the remaining information selectable. The navigator may then select only what is essential for the navigational task at hand. A black background display for night use provides good color contrast

without compromising the mariner's night vision. Similarly, a "bright sun" color table is designed to output maximum luminance in order to be daylight visible, and the colors for details such as buoys are made as contrasting as possible.

The symbols for ENCs are based on the familiar paper chart symbols, with some optional extras such as simplified buoy symbols that show up better at night. Since ECDIS and ECS can be customized to each ship's requirements, new symbols were added such as a highlighted, mariner selectable, safety contour and a prominent isolated danger symbol. See Figure 506a and Figure 506b for an examples.

The Presentation Library is a set of colors and symbols together with rules relating them to the digital data of the ENC, and procedures for handling special cases, such as priorities for the display of overlapping objects. Every feature in the ENC is first passed through the look-up table of the Presentation Library that either assigns a symbol or line style immediately, or, for complex cases, passes the object to a symbology procedure. Such procedures are used for objects like lights, which have so many variations that a look-up table for their symbolization would be too long. The Presentation Library includes a Chart 1, illustrating the symbology. Given the IHO S-57 data standards and S-52 display specifications, a waterway should look the same no matter which hydrographic office produced the ENC, and no matter which manufacturer built the ECDIS.

The overwhelming advantage of the vector-based ECDIS or ECS display is its ability to remove cluttering

information not needed at a given time. By comparison, the paper chart and its raster equivalent is an unchangeable diagram. A second advantage is the ability to orient the display course-up when this is convenient, while the text remains screen-up.

Taking advantage of affordable yet high-powered computers, some ECDIS and ECS now permit a split screen display, where mode of motion, orientation and scale are individually selectable on each panel. This permits, for example, a north-up small-scale overview in true motion alongside a course-up large-scale view in relative motion. Yet another display advantage occurs with zooming, in that symbols and text describing areas center themselves automatically in whatever part of the area appears on the screen. None of these functions are possible with raster charts.

The display operates by a set of rules, and data is arranged hierarchically. For example, where lines overlap, the less important line is not drawn. A more complex rule always places text at the same position relative to the object it applies to, no matter what else may be there. Since a long name or light description will often over-write another object, the only solution is to zoom in until the objects separate from each other. Text is written automatically when the object it refers to is on the display. Because it causes so much clutter, and is seldom vital for safe navigation, it, text portrayal is an option under the “all other information” display level.

Flexibility in display scale requires some indication of distance to objects seen on the display. Some manufacturers use the rather restrictive but familiar radar range rings to provide this, while another uses a line symbol keyed to data's original scale. The ECDIS design also includes a one-mile scalebar at the side of the display, and an optionally displayed course and speed-made-good vector for own ship. There may be a heading line leading from the vessel's position indicating her future track for one minute, three minutes, or some other selectable time.

To provide the option of creating manual chart corrections, ECDIS includes a means of drawing lines, adding text and inserting stored objects on the display. These may be saved as user files, called up from a subdirectory, and edited on the display. Once loaded into the SENC, the objects may be selected or de-selected just as with other objects of the SENC.

Display options for ECDIS and ECS include transfer of ARPA-acquired targets and radar image overlay. IMO standards for ECDIS require that the operator be able to deselect the radar picture from the chart with a single operator action for fast “uncluttering” of the chart presentation.

In the 2014 Presentation Library update, several changes were made to include:

- A new “Detection and Notification of Navigational Hazard” section: For each ENC feature and its associated attributes, ECDIS will define the priority of an alert to be raised when a navigational hazard is detected.
- A new “Detection of Areas, for which Special

Conditions Exist” section: This lists the ENC features and attributes that will raise an indication or alert in the ECDIS as defined by the mariner.

- The ability to turn on and off isolated dangers in shallow water.
- New standardized symbols to identify where automatic ENC updates have been applied and indicate where features with temporal attributes are located.
- Display names of anchorage areas and fairways.
- A means for the mariner to insert a date or date range within the ECDIS to display date dependent features.

507. Units, Data Layers and Calculations

ECDIS uses the following units of measure:

- **Position:** Latitude and longitude will be shown in degrees, minutes, and decimal minutes, normally based on WGS-84 datum.
- **Depth:** Depths will be indicated in meters and decimeters.
- **Height:** Meters
- **Distance:** Nautical miles and tenths, or meters
- **Speed:** Knots and tenths

ECDIS requires data layers to establish a priority of data displayed. The minimum number of information categories required and their relative priority from highest to lowest are listed below:

- ECDIS warnings and messages
- Hydrographic office data
- *Notice to Mariners* information
- Hydrographic office cautions
- Hydrographic office color-fill area data
- Hydrographic office on demand data
- Radar information
- User's data
- Manufacturer's data
- User's color-fill area data
- Manufacturer's color-fill area data

As a minimum, an ECDIS system must be able to perform the following calculations and conversions:

- Geographical coordinates to display coordinates, and display coordinates to geographical coordinates.
- Transformation from local datum to WGS-84.
- True distance and azimuth between two geographical positions.
- Geographic position from a known position given distance and azimuth.
- Projection calculations such as great circle and rhumb line courses and distances.

508. Alerts and Indications

Knowledge and ability to interpret and react to the









ENC Symbol	Explanation	Additional Information
	Generic isolated danger symbol – with less depth than user-selected safety contour or where the depth is unknown	Wreck, rock or obstruction
	Sounding of low accuracy	Equates to sounding of doubtful depth
	6 stars A1 All significant seafloor features detected; very high accuracy survey 5 stars A2 All significant seafloor features detected; high accuracy survey 4 stars B Uncharted features dangerous to navigation are not expected but may exist; medium accuracy survey 3 stars C Depth anomalies may be expected; low accuracy survey or passage soundings 2 stars D Large depth anomalies may be expected; poor quality data U Quality of bathymetry yet to be assessed	
	Caution area where a specific caution note applies	Refer to cursor enquiry to access additional information Refer to ECDIS Chart I for more examples
	Dredged area deeper than safety contour Darker blue indicates water shoaler than safety contour	Refer to cursor enquiry for more information
	Vertical lines indicate areas of charted data at significantly smaller scale than main display	Zoom out until vertical lines disappear to view at scale appropriate to data
	Indicates boundary between IALA A and B buoyage systems	
	Isolated query indicates insufficient information to symbolise the feature Query associated with symbol indicates absence of a mandatory attribute, such as beacon shape, direction or orientation	Query may appear alone at a point, on a line or in a defined area. Further information may be obtained from cursor enquiry of the query
	Limit between area of unofficial vector data and official ENC data, marked by orange pecked line – pecks angled towards unofficial vector data	May be shown the other way around on older ECDIS. Within areas of non-ENC data, an alternative, official chart must be used for navigation

Figure 506a. Example of ENC symbology.

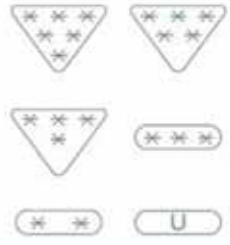
ECDIS alarms requires the understanding the conditions that trigger alarms or indications. Appendix 5 of the IMO Performance Standard specifies that ECDIS must monitor the status of its systems continuously, and must provide alarms and indications for certain functions if a condition

occurs that requires immediate attention. Indications may be either visual or audible. An alarm must be audible and may be visual as well (It is important to note significant changes are coming to this crucial functionality in new ECDIS on August 1, 2017 and not currently reflected here).























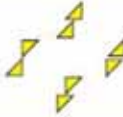

ENC Symbol		Explanation	Additional Information
		Indicates that an additional information note or picture file is available	The information, note or graphic can be found using cursor enquiry
		Non-tidal current direction	
		Spring tide - Ebb	
		Flood	
		Light vessel/lightfloat	
		Daymarks	
		New Object - Point New Object - Line New Object - Area	New type of feature not yet known to ECDIS - further information available by cursor enquiry
Symbol setting on ECDIS		For details of the IALA Maritime Buoyage System.	
Simplified	Traditional		
		Lateral beacons - red/green	IALA applicable system
		Lateral conical buoys - red/green, according to applicable IALA system	IALA applicable system
		Lateral can buoys - red/green	IALA applicable system
		Cardinal marks north/east/south/west (Cardinal mark north shown for Traditional)	
		Isolated danger marks	
		Safe water buoy	
		Special marks	Shape/topmarks are optional - colour yellow
		Special purpose buoys, for example; TSS lane markers	Shape/topmarks optional - colour yellow
		Buoy - mooring	

Figure 506b. Example of ENC symbology.

An alarm is required for the following:

- Exceeding cross-track limits
- Crossing selected safety contour
- Deviation from route
- Position system failure
- Approaching a critical point
- Chart on different geodetic datum from positioning system

An alarm or indication is required for the following:

- Largest scale for alarm (indicates that presently loaded chart is too small a scale to activate anti-grounding feature)
- Area with special conditions (means a special type of chart is within a time or distance setting)
- Malfunction of ECDIS (means the master unit in a master-backup network has failed)

An indication is required for the following:

- Chart overscale (zoomed in too close)
- Larger scale ENC available
- Different reference units (charted depths not in meters)
- Route crosses safety contour
- Route crosses specified area activated for alarms
- System test failure

As these lists reveal, ECDIS has been programmed to constantly “know” what the navigation team should know, and to help the team to apply its experience and judgment through the adjustment of operational settings.

This automation in ECDIS has two important consequences: First, route or track monitoring does not replace situational awareness; it only enhances it. The alarm functions, while useful, are partial and have the potential to be in error, misinterpreted, ignored, or overlooked.

Secondly, situational awareness must now include, especially when ECDIS is used as the primary means of navigation, the processes and status of the electronic components of the system. This includes all attached sensors, the serial connections and communication ports and data interfaces, the computer processor and operating system, navigation and chart software, data storage devices, and power supply. Furthermore, these new responsibilities must still be balanced with the traditional matters of keeping a vigilant navigational watch.

ECDIS or not, the windows in the pilothouse are still the best tool for situational awareness. Paradoxically, ECDIS makes the navigator’s job both simpler and more complex.

It is expected the **new ECDIS standards** when released and implemented (August 1, 2017) will provide better alarm management. Reducing alarm fatigue, the ECDIS will produce audible alarms for only three conditions: Anti-grounding, anti-route, and anti-collision. Visual alerts and indications will display in four categories: Warning, Caution, Indication, and Permanent. Aiding the mariner with alarm privatization, the new ECDIS will use a color coding system:

- Red - visible and audible alarm that will require immediate action
- Orange - visual indication that needs attention

- Yellow - visual indication that needs to be addressed in time

Orange and yellow indications can be upgraded to red if not addressed.

509. ECDIS Outputs

During the past 12 hours of the voyage, ECDIS must be able to reconstruct the navigation and verify the official database used. Recorded at one minute intervals, the information includes:

- Own ship’s past track including time, position, heading, and speed
- A record of official ENC used including source, edition, date, cell and update history

It is important to note that if ECDIS is turned off, such as for chart management or through malfunction, voyage recording ceases, unless a networked backup system takes over the functions of the master ECDIS. In that case, the voyage recording will continue, including an entry in the electronic log for all the alarms that were activated and reset during the switchover. Voyage files consist of logbook files, track files and target files. The file structure is based on the date and is automatically created at midnight for the time reference in use. If the computer system time is used for that purpose, the possibility exists for overwriting voyage files if the system time is manually set back. Allowing GPS time as the system reference avoids this pitfall.

In addition, ECDIS must be able to record the complete track for the entire voyage with time marks at least once every four hours. ECDIS should also have the capability to preserve the record of the previous 12 hours of the voyage. It is a requirement that the recorded information be inaccessible to alteration. Preserving voyage files should follow procedures for archiving data. Unless radar overlay data is being recorded, voyage files tend to be relatively small, permitting backup onto low-capacity media, and purging from system memory at regular intervals. (This form of backing up should not be confused with the network master-slave backup system.)

Adequate backup arrangements must be provided to ensure safe navigation in case of ECDIS failure. This includes provisions to take over ECDIS functions so that an ECDIS failure does not develop into a critical situation, and a means of safe navigation for the remaining part of the voyage in case of complete failure.

510. Voyage Data Recorder (VDR)

The purpose of the voyage data recorder (VDR) is to provide accurate historical navigational data in the investigation of maritime incidents. It is additionally useful for system performance monitoring. A certified VDR configuration records all data points, as per IMO Resolution A.861(20) & EC Directive 1999/35/EC. Some of the voy-

age data can be relayed through ECDIS. A fully IEC compliant data capsule passes fire and immersion tests.

SOLAS chapter V, regulation 20 affects ships more than 3,000 gross tons sailing internationally. As of 2010, these ships are required to properly install a VDR or simplified Voyage Data Recorder (s-VDR). Ship owners may apply for an exemption through their Administration.

VDR features include:

- Navigation information recording: ship's position, date and time, current chart, last chart update, speed heading, radar data, Automatic Identification System data, echo depth sounder.
- Internal conditions recording: bridge audio, ship's alarm system, rudder order and response, engine order and response, hull openings (door) status,

watertight and fire door status, accelerations and hull stress.

- External conditions recording: communications audio, wind speed and direction.
- Uninterruptible power supply (UPS): provided through battery operated UPS or through ship's emergency electrical power supply.
- Hardened fixed data capsule.
- Remote data recovery and shoreside playback: Options available in several systems.
- Annual system certification: The IMO requires that the VDR system, including all sensors, be subjected to an annual performance test for certification.

DATA FORMATS

511. Official Vector Data

How ECDIS and ECS operate depends on what type of chart data is used. ENC's (electronic navigational charts) and RNC's (raster navigational charts) are approved for use in ECDIS. By definition both ENC's and RNC's are issued under the authority of national hydrographic offices (HO's). ECDIS functions as a true ECDIS when used with corrected ENC data, but ECDIS operates in the less functional raster chart display system (RCDS) mode when using corrected RNC data. When ECDIS is used with non-official vector chart data (corrected or not), it operates in the ECS mode.

In vector charts, hydrographic data is comprised of a series of files in which different layers of information are stored or displayed. This form of "intelligent" spatial data is obtained by digitizing information from existing paper charts or by storing a list of instructions that define various position-referenced features or objects (e.g., buoys, lighthouses, etc.). In displaying vector chart data on ECDIS, the user has considerable flexibility and discretion regarding the amount of information that is displayed.

An ENC is vector data conforming to the IHO S-57 ENC product specification in terms of content, structure and format. An ENC contains all the chart information necessary for safe navigation and may contain supplementary information in addition to that contained in the paper chart. In general, an S-57 ENC is a structurally layered data set designed for a range of hydrographic applications. As defined in IHO S-57 Edition 3, the data is comprised of a series of points, lines, areas, features, and objects. The minimum size of a data set is a cell, which is a spherical rectangle (i.e., bordered by meridians and latitudes). Adjacent cells do not overlap. The scale of the data contained in the cell is dependent upon the navigational purpose (e.g., general, coastal, approach, harbor).

Under S-57, cells have a standard format but do not

have a standard coverage size. Instead, cells are limited to 5mb of data. S-57 cells are normally copy protected and therefore require a permit before use is allowed. These permits are delivered as either a file containing the chart permits or as a code. In both cases the first step is to install the chart permit into the ECDIS. Some hydrographic offices deliver S-57 cells without copy protection and therefore permits are not required.

Any regional agency responsible for collecting and distributing S-57 data, such as PRIMAR and IC-ENC, will also maintain data consistency. National hydrographic offices are responsible for producing S-57 data for their own country area. Throughout the world, hydrographic offices have been slow to produce sufficient quantities of ENC data. This is the result of standards that have been evolving over several years, and that vector data is much harder to collect than raster data.

Several commercial manufacturers have developed non S-57 vector databases beyond those that have been issued by official hydrographic offices. These companies are typically manufacturers of ECDIS or ECS equipment or have direct relationships with companies that do, and typically have developed data in proprietary format in order to provide options to raster charts in the absence of ENC data. HO-issued paper charts provide the source data for these formats, although in some cases non-official paper charts are used. In some cases, ECS manufacturers provide a regular updating and maintenance service for their vector data, resulting in added confidence and satisfaction among users. The manufacturer's source of the updates is through the HO. Hence, these two particular non-official formats allow for a very high degree of confidence and satisfaction among mariners using this data.

ECS sometimes apply rules of presentation similar to officially specified rules. Thus information is displayed or removed automatically according to scale level to manage

clutter. The same indications pertinent to overscaling ENC apply to private vector data. Since the chart data is not ENC, the systems must display that nonofficial status when used in an ECDIS.

512. IHO S-100

S-57, the current IHO Transfer Standard for Digital Hydrographic Data, adopted in 1992, was created to support multiple hydrographic data types and associated software. It is an encapsulation and encoding specification guide used for ENC and ECDIS. The S-57 limitations in flexibility stem not from updating the specifications, but from the manufacturer and shipping company update cycles; this potential time gap puts the mariner to sea with systems in non-compliance with current specification. In 2001, S-100, the IHO Universal Hydrographic Data Model, was put into the work plan of the IHO Transfer Standards Maintenance and Applications Development (TSMAD) Working Group. In 2010, it was adopted by the IHO and became an active international encapsulation standard. In order to ensure the mariner has the most up to date information that can be displayed properly, S-100 aligns with international geospatial standards, in particular ISO19100. This will allow easier integration of data and applications into GIS based solutions. S-100 will eventually replace the encapsulation segment S-57 while S-101 will replace the encoding segment of S-57.

S-100 supports a broader base of data sources, such as imagery, gridded data, high-density bathymetry, 3-D, and data with time variances. S-57 is limited with its fixed maintenance system and it cannot support future requirements without manufacturer development. One of the new features of S-100 will be the addition of the portrayal catalog, a rule set for depicting encoded features as graphics. This eliminates the dependency of updates to the specifications on manufacturer development. This allows the mariner access to the latest specification updates outside of bridge maintenance cycles. As geospatial information has become more and more prevalent in the maritime world, S-100 allows for a common encapsulation for the various data streams including charts, bathymetry, messages, and aids to navigation. Improvements and extensions will be developed with the help of the GIS domain, instead of isolated from it. S-100 will also allow government and commercial organizations to better support the applications, bringing the cost of upkeep lower and reaching a broader spectrum of clients and allow for data sharing. It will be well-suited for use with web-based applications to better acquire, process, analyze and present data.

Benefits of S -100 include:

- Portrayal catalogs
- Feature catalogs
- Flexible version control

- Improved metadata storage
- Spatial geometry
- Use of imagery and gridded data
- Multiple encodings
- Standardized product specifications
- Continuous maintenance

From the S-100 framework, the S-101 ENC Product Specification is being developed. It will take several years before S-100 and S-101 are fully implemented; development of the S-101 test bed, ECDIS on-shore and sea trials, Original equipment manufacturer (OEM) development of ENC Production Systems are still in work. After S-101 is released for operational use, projected for 2019, conversion of data from S-57 to S-101 data will need to take place as well as Electro-optical multifunction system (EOMS) executing S-100 based ECDIS for use.

Additional information about S-100 is available for download from the web via the link provided in Figure 512.



Figure 512. IHO information on the S-100 Universal Hydrographic Data Model.

https://www.iho.int/srv1/index.php?option=com_content&view=article&id=586&Itemid=1011&lang=en

513. Raster Data

Raster navigational chart (RNC) data is stored as picture elements (pixels). Each pixel is a minute component of the chart image with a defined color and brightness level. Many new RNC are created from the vector data used for ENC and DNC. However, raster-scanned images are derived by scanning paper charts to produce a digital photograph of the chart. In either case, raster data may appear more familiar, but it presents many limitations to the user.

The official raster chart formats are:

- ARCS (British Admiralty)
- Seafarer (Australia)
- BSB (U.S., NOAA)

These charts are accurate representations of the paper

chart with every pixel geographically referenced. Where applicable, horizontal datum shifts are included with each chart to enable referencing to WGS84. This permits compatibility with information overlaid on the chart. *Note: Not all available charts have WGS84 shift information.* Extreme caution is necessary if the datum shift cannot be determined exactly.

Raster nautical charts require significantly more computer memory than do vector charts to be displayed. Whereas a world portfolio of more than 7500 vector charts may occupy about 500mb, a typical coastal region in raster format may consist of just 40 charts and occupy more than 1000mb of memory. For practical reasons, most of a portfolio of raster charts should not be loaded into the ECDIS hard drive unless one is route planning or actually sailing in a given region. To update RNC the user typically must load a new version of the chart.

Certain non-official raster charts are produced that cover European and some South American waters. These are scanned from local paper charts. Additionally, some ECDIS and ECS manufacturers also produce raster charts in proprietary formats.

In 1998 the IMO's Maritime Safety Committee (MSC 70) adopted the Raster Chart Display System (RCDS) as Appendix 7 to the IMO Performance Standards. The IMO-IHO Harmonization Group on ECDIS (HGE) considered this issue for over three years. Where IHO S-57 Ed. 3 ENC data coverage is not available, raster data provided by official HO's can be used as an interim solution. But this RCDS mode does not have the full functionality of an otherwise IMO-compliant ECDIS using ENC data. Therefore, RCDS does not meet SOLAS requirements for carriage of paper

charts, meaning that when ECDIS equipment is operated in the RCDS mode, it must be used together with an appropriate portfolio of corrected paper charts.

Some of the limitations of RCDS compared to ECDIS include:

- Chart features cannot be simplified or removed to suit a particular navigational circumstance or task.
- Orientation of the RCDS display to course-up may affect the readability of the chart text and symbols since these are fixed to the chart image in a north-up orientation.
- Depending on the source of the raster chart data, different colors may be used to show similar chart information, and there may be differences between colors used during day and night time.
- The accuracy of the raster chart data may be less than that of the position-fixing system being used.
- Unlike vector data, charted objects on raster charts do not support any underlying information.
- RNC data will not trigger automatic alarms. (However, some alarms can be generated by the RCDS from user-inserted information.).
- Soundings on raster charts may be in fathoms and feet, rather than meters.

The use of ECDIS in RCDS mode can only be considered as long as there is a backup folio of appropriate up-to-date paper charts.

INTEGRATED BRIDGE SYSTEMS

514. Description

An Integrated Bridge System (IBS) is a combination of equipment and software that use interconnected controls and displays to present a comprehensive suite of navigational information to the mariner. Rules from classification societies such as Det Norske Veritas (DNV) specify design criteria for bridge workstations. Their rules define tasks to be performed, and specify how and where equipment should be sited to enable those tasks to be performed. Equipment carriage requirements are specified for ships according to the requested class certification or notation. Publication IEC 61029 defines operational and performance requirements, methods of testing, and required test results for IBS.

Classification society rules address the total bridge system in four parts: technical system, human operator, man/machine interface, and operational procedures. The DNV classifies IBS with three certifications: NAUT-C covers bridge design; W1-OC covers bridge design; instrumentation and bridge procedures; W1 augments cer-

tain portions of W1-OC.

An IBS generally consists of at least:

- Dual ECDIS installation – one serving master and the other as backup and route planning station
- Dual radar/ARPA installation
- Conning display with a concentrated presentation of navigational information (the master ECDIS)
- DGPS positioning
- Ship's speed measuring system
- Auto-pilot and gyrocompass system
- Full GMDSS functionality

Some systems include full internal communications, and a means of monitoring fire control, shipboard status alarms, and machinery control. Additionally, functions for the loading and discharge of cargo may also be provided.

An IBS is designed to centralize the functions of monitoring collision and grounding risks, and to automate navigation and ship control. Control and display of compo-

ment systems are not simply interconnected, but often share a proprietary language or code. Several instruments and indicators are considered essential for safe and efficient performance of tasks, and are easily readable at the navigation workstation, such as heading, rudder angle, depth, propeller speed or pitch, thruster azimuth and force, and speed and distance log.

Type approval by Det Norske Veritas for the DNV-W1-ANTS (Automatic Navigation and Track-Keeping System) certification is given to ship bridge systems designed for one-man watch (W1) in an unbounded sea area. DNV also provides for the other two class notations, NAUT-C and W1-OC. The W1 specifications require the integration of:

- CDIS (providing the functions of safety-contour checks and alarms during voyage planning and execution)
- Manual and automatic steering system (including software for calculation, execution and adjustments to maintain a pre-planned route, and including rate of turn indicator)
- Automatic Navigation and Track-keeping System (ANTS)
- Conning information display
- Differential GPS (redundant)
- Gyrocompass (redundant)
- Radar (redundant) and ARPA
- Central alarm panel
- Wind measuring system

- Internal communications systems
- GMDSS
- Speed over ground (SOG) and speed through water (STW or Doppler log)
- Depth sounder (dual transducer >250m)
- Course alteration warnings and acknowledgment
- Provision to digitize paper charts for areas not covered by ENC data

The W1 classification requires that maneuvering information be made available on the bridge and presented as a pilot card, wheelhouse poster, and maneuvering booklet. The information should include characteristics of speed, stopping, turning, course change, low-speed steering, course stability, trials with the auxiliary maneuvering device, and man-overboard rescue maneuvers.

The W1-OC and W1 classifications specify responsibilities of ship owner and ship operator, qualifications, bridge procedures, and particular to W1, a requirement for operational safety standards. The W1 operational safety manual requires compliance with guidelines on bridge organization, navigational watch routines, operation and maintenance of navigational equipment, procedures for arrival and departure, navigational procedures for various conditions of confinement and visibility, and system fallback procedures. Both classifications also require compliance with a contingency and emergency manual, including organization, accident, security, evacuation, and other related issues.

MILITARY ECDIS

515. ECDIS-N

In 1998, the U.S. Navy issued a policy letter for a naval version of ECDIS, called ECDIS-N, and included a performance standard that not only conforms to the IMO Performance Standards, but extends it to meet unique requirements of the U.S. Department of Defense.

A major difference from an IMO-compliant ECDIS is the requirement that the ECDIS-N SENC must be the Digital Nautical Chart (DNC) issued by the National Geospatial-Intelligence Agency (NGA). The DNC conforms to the U.S. DoD standard Vector Product Format (VPF), an implementation of the NATO DIGEST C Vector Relational Format..

The U.S. Navy uses the Voyage Management System (VMS) software as the ECDIS-N compliant system. Greater than 95% of the fleet is certified to operate without paper charts. VMS was selected for use by the Navy in 2002, based on the large presence of VMS in the surface fleet Integrate Bridge Systems and in the submarine fleet BPS radar system. The current series of VMS software, the 9.x

series, is being fielded in 2017. This will replace the 6.x, 7.x and 8.x versions in the fleet and reduce the number of fielded variants of VMS. In addition to VMS, many ships and combatant craft use the Common Geospatial Extensible Navigation Toolkit (COGENT) 2.4 software for electronic chart navigation situational awareness and mission support.

The Navy plans to replace the ECDIS-N with a new program of record called **Navy ECDIS**. Navy ECDIS will be based on the NATO Warship ECDIS (WECDIS) standard and also on a U.S. Navy specific Software Requirements Document (SRD). The Navy ECDIS software is being procured competitively and is expected to start fielding in 2019.

516. The Digital Nautical Chart

NGA produces DNC, a vector-based digital product housed in a global database designed to support marine navigation and Geographic Information Systems (GIS) applications. This product contains vector data and feature content thematically layered and relationally structured to

support ECDIS. DNC is produced in the standard VPF, a non s-57 data format, and conforms to DNC (MIL-PRF-80923) specifications, which allows for modeling real world features in digital geographic databases. The database underlying the DNC portfolio uses a table-based georelational data model containing significant maritime features considered essential for safe marine navigation. It is designed to conform to the IMO Performance Standard and IHO specifications for ECDIS.

The DNC database is based on and developed with feature content from traditional paper charts produced by NGA and NOS. This content is updated regularly with both for-

oreign partner charts and NOS charts to reflect the latest information from the various charting authorities. Although the majority of the DNC portfolio is unclassified, a significant portion is labeled Limited Distribution (LIMDIS) to protect the copyrights and sensitive feature data provided by NGA's foreign partners, therefore, DNC is primarily developed and maintained for use by Department of Defense (DoD) agencies and departments including, the U.S. Navy, U.S. Coast Guard, government agencies, and government/US military sponsored contractors. DNC data for U.S. waters is generally available for public use and is available for download from NGA's website.

DNC Library Categories		
Library Category	Scale	Purpose
General	> 1:500K	The smallest scale charts used for planning, fixing position at sea, and for plotting while proceeding on an ocean voyage. The shoreline and topography are generalized and only offshore soundings, the principal navigational lights, outer buoys, and land-marks visible at considerable distances are shown.
Coastal	1:75K - 1:500K	Intended for inshore coastwise navigation where the course may lie inside outlying reefs and shoals, for entering or leaving bays and harbors of considerable width, and for navigating large inland waterways.
Approach	1:25K - 1:75K	Intended for approaching more confined waters such as bays or harbors.
Harbor	1 < 1:50K	Intended for navigation and anchorage in harbors and small waterways
Browse Index	1:3,1000,000	Provides a global overview of the DNC coverage displaying geographical boundaries.

Table 516a. DNC library categories according to scale.

The DNC database consists of 29 DNC geographic regions that provide a worldwide footprint containing over 5,000 charts of varying scales resulting in global coverage between 84 degrees N and 81 degrees S. The 29 regions are further broken down by libraries. The DNC portfolio comprises some 3,800 or more DNC libraries created from over 8,600 Standard Nautical Charts (SNC). Each DNC library represents a different geographic area of interest and level of detail (i.e. scale). The libraries are organized as tiles according to the World Geodetic Reference System (GEOREF) tiling scheme. The libraries have been designed to support various navigation and piloting maneuvers as well as GIS applications.

The Horizontal datum in DNC is WGS 84 (considered equivalent to NAD 83 in the U.S.). There are three vertical datums within the DNC database; two vertical datums related are topographic and the third is hydrographic. Topographic features are referenced to Mean Sea Level,

and the shoreline is referenced to Mean High Water. Hydrography is referenced to a low water level most suitable for the region being charted. All measurements are metric.

The DNC data is stored in libraries; each library represents a different geographic area of interest and level of detail (i.e. scale). The libraries are as tiles according to the World Geodetic Reference System (GEOREF) tiling scheme. The DNC contains four library categories: Harbor, Approach, Coastal, and General, based on scale (from largest to smallest scale, respectively) and purpose. A Browse Index provides library names and footprints.

The DNC data is grouped and stored in the following five library scales in Table 516a. For voyage planning NGA provides a DNC Regions graphic, which is available on the DNC website (see Figure 516a).

The naming convention used for Harbor and Approach libraries are the same (e.g., H0145820 or A1708470). The first character signifies the category type (Harbor or Ap-

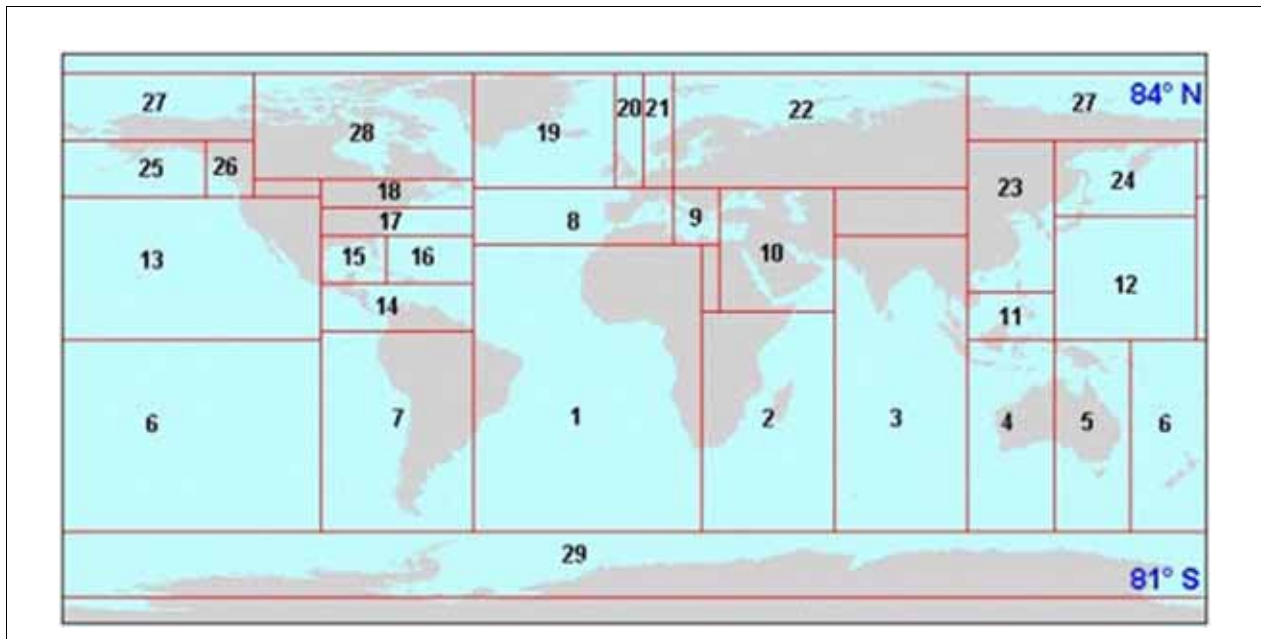

Figure 516a. DNC Regions graphic.

proach). The next two characters are the DNC geographic region number (e.g., 17 is the East Coast of the United States). The last five characters are the five-digit World Port Index (WPI) number.

The naming convention used for Coastal and General libraries start with a three letter code (COA or GEN) followed by the two-digit disc/geographic region number and a letter if the disc includes more than one library of that type (e.g., GEN1720a and GEN20b). The World Port Index reference is not included in the Coastal and General library naming convention.

DNC data is classified into and layered in 12 related feature class thematic layers:

- Cultural Landmarks (CUL)
- Data Quality (DQY)
- Earth Cover (ECR)
- Environment (ENV)
- Hydrography (HYD)
- Inland Waterways (IWY)
- Landcover (LCR)
- Limits (LIM)
- Aids to Navigation (NAV)
- Obstructions (OBS)
- Port Facilities (POR)
- Relief (REL)

Also, there are two additional layers found within the DNC data structure called Library Reference (LIBREF) and Tile Reference (TILEREF). These layers are used within the ECDIS-N to find the stored DNC data. DNC content is generally aligned to mirror what is found on a Standard Nautical Chart (SNC) printed on paper. However, one of

the advantages of a digital product is the ability to provide the mariner with additional information when necessary to help them augment their understanding of the navigation space.

The publicly releasable DNC data is available for download at the following web location:

WWW: <https://dnc.nga.mil>

The full set of DNC data, to include the Limited Distribution information, is available via the following web locations:

NIPRNET:

<https://dnc.geo.nga.mil/NGAPortal/DNC.portal>

SIPRNET:

<http://dnc.nga.smil.mil/NGAPortal/DNC.portal>

JWICS:

<http://dnc.nga.ic.gov/NGAPortal/DNC.portal>

Tactical Ocean Data (TOD) is an overlay to DNC. TOD data is bathymetric in nature and intended to support naval operations. Original TOD specifications provide for a total of six levels as outlined below:

Level 0 - OPAREA, Range, and Naval Exercise Areas (NAVEX) charts

Level 1 - Bottom Contour Charts (BC)

Level 2 - Bathymetric Navigation Planning Charts (BNPC)

Level 3 - Shallow Water Charts

Level 4 - Hull Integrity Test Charts

Level 5 - Strategic Straits Charts

In recent years, change in policy resulted in the combination of TOD levels 1, 3 and 5 into TOD Level 2. The

current TOD Levels are referenced below:

Level 0 - OPAREA, Range, and Naval Exercise Areas (NAVEX) charts

- TOD0 provides worldwide databases of nautical information in Vector Product Format (VPF). The data content and coverage is intended to closely replicate NGA's Naval Operating Area (OPAREA) Chart, Range Chart, and Naval Exercise Area (NAVEX) Chart series.

Level 2- Bathymetric Navigation Planning Charts (BNPC)

- TOD2 provides worldwide databases of nautical information in Vector Product Format (VPF). The data content and coverage is intended to closely replicate NGA's Bathymetric Navigation Planning Chart (BNPC) series. includes data from:
 - Bottom Contour Charts (BC)
 - Shallow Water Charts
 - Strategic Straights Charts

Level 4- - Hull Integrity Test Charts (HITS)

- TOD4 is a vector-based digital product that portrays detailed bathymetric data for submarine Hull Integrity Test Sites (HITS) in a format suitable for computerized subsurface navigation. TOD4 data is designed for use during submarine hull integrity tests conducted as a part of builder's trials and after submarine hull maintenance. TOD4 data is provided primarily to support deep submergence rescue vessel operations and to enhance coordination between units during escorted test dives.

517. Differences Between NOAA ENC and DNC

The NOAA ENC is based on the International Hydrographic Organization Transfer Standard for Digital Hydrographic Data, Publication S-57 and is approved by the International Maritime Organization for SOLAS class vessels to use for navigation in an ECDIS. NOAA and the U.S. Army Corps of Engineers (USACE) are producing ENCs for the coastal and inland waters of the U.S. Most hydrographic offices throughout the world are producing vector charts in ENC format.

NGA produces ENC cells over areas where NGA is considered the charting authority such as Haiti, the Pacific Islands, and parts of Antarctica. In these areas, NGA is responsible for civilian shipping and is required to provide ENC to facilitate the International Maritime Organization (IMO) mandate for electronic charting. NGA ENC cells are available for download through the NOAA website.

DNC produced by the NGA, is unclassified, vector-based, digital database containing maritime significant features essential for safe marine navigation. The

DNC uses the Vector Product Format, which is a NATO standard for digital military map and chart data. NGA produces DNCs for worldwide coverage.

ENC was developed for civil navigation, with an initial emphasis on commercial navigation. DNC was developed for the military user for multiple roles; it can be combined with land, air and tactical data layers for various military uses such as littoral warfare.

During the creation of a NOAA ENC, high-resolution source information was used in portraying channels, aids to navigation, and other important features. Today, NOAA ENC data is updated by incorporating high resolution source information from a variety of sources. DNCs covering U.S. waters were created by digitizing paper NOAA charts.

The NOAA ENC files are updated using weekly USCG Local Notice to Mariners and NGA Notice to Mariners. DNCs are updated on a monthly basis using NGA Notice to Mariners. For US Waters, NGA updates the data inside the 12' contour by using USCG local notices.

518. Warship ECDIS (WECDIS)

WECDIS is defined by NATO Standard ANP-4564. WECDIS is a system which takes inputs from and provides information to disparate tactical sources (including the Command System), providing the user with a controllable set of information additions to overlay onto electronic charting and position displays for safety of navigation and enhanced tactical awareness. WECDIS is delivered via a dedicated user interface and chart display. When required by the user (for example in a benign tactical environment) WECDIS shall be capable of operation as an IMO compliant ECDIS. The primary function of WECDIS is to enhance military mission effectiveness by supporting safe and efficient navigation.

The IMO Performance Standards for ECDIS define the minimum requirements for functionality with respect to route planning, monitoring, alarms and voyage recording. However, warships can be operated under circumstances not anticipated by IMO, to include the core WECDIS capabilities of dived navigation, high speed navigation, waterspace management, integration of Additional Military Layers (AML) and the transfer of NATO User Defined Layers (NUDL) between NATO units. These circumstances impose additional requirements on WECDIS beyond those mandated by IMO.

WECDIS based solely on IMO specifications will not achieve the functionality required in a wartime scenario. Therefore NATO adds its own requirements in this WECDIS standard; these can be further expanded based on national requirements.

Although warships, naval auxiliaries, other ships owned or operated by a contracting government and used

only on governmental non-commercial service are exempt from the provisions of SOLAS Chapter V Regulations 18 and 19 (Ref A). WECDIS shall have the capability to be functionally compliant with the requirements of the latest IMO ECDIS performance and IHO chart presentation standards when selected by the user. Nations shall ensure that appropriate verification is completed to ensure functional compliance with IMO performance standards when operating in this mode.

Two operational modes, WECDIS mode and IMO

compliant mode, categorize the requirements listed in this standard:

WECDIS mode: the system is operating in this mode when any of the currently activated system functionalities render it non ECDIS IMO compliant.

IMO compliant mode: the system is operating in this mode when all the currently activated system functionalities do not compromise ECDIS IMO regulations compliance.

CORRECTING ELECTRONIC CHARTS

519. ECDIS Correction Systems

ECDIS software creates a database from the ENC data called the SENC and from this selects information for display. The ECDIS software meanwhile receives and processes serial data from navigational sensors and displays that textual and graphical information simultaneously with the SENC information.

It is the SENC that is equivalent to up-to-date charts, as stated by the Performance Standards. As originally conceived, ECDIS was designed to use internationally standardized and officially produced vector data called the ENC (electronic navigational chart). Only when using ENC data can ECDIS create a SENC, and thereby function in the ECDIS mode.

Updates for ENC are installed into the ECDIS separate from the ENC data itself. For the mariner, this involves activating a special utility accompanying the ECDIS and following the on-screen prompts. Within this same utility, update content and update log files in textual form can be viewed. Once the ECDIS software itself is reactivated, the update information is accessed in conjunction with the ENC data and the SENC database is created.

Just as ENC and updates are transformed into the SENC, so too are other data types accessed and combined. The user has the option to add lines, objects, text and links to other files supported by application. Referred to in the Performance Standards as data added by the mariner, these notes function as layers on the displayed chart. The user can select all or parts of the layers for display to keep clutter to a minimum. The mariner's own layers, however, must be called into the SENC from stored memory. As a practical matter, not only must the mariner take care to associate file names with actual content, such as with manually created chart corrections, but also must realize that the files themselves do not have the tamper-proof status that ENC and official updates have. Special care should be given when cells are canceled in the SENC database. These cells will not be subject to further updates and the cell will become out-of-date. The mariner should remove the ENC from the SENC when prompted to avoid accidental future use.

Within the SENC resides all the information available for the display. The Presentation Library rules such as Stan-

dard Display and Display Base define what levels of information from the SENC can be shown. An ENC updating profile is contained within the IHO S-57 Edition 3.0 specification. This enables the efficient addition, removal or replacement of any line, feature, object or area contained within the ENC dataset. Guidance on the means and process for ENC updating is provided in IHO S- 52, Appendix 1. In terms of what is called for in the IMO Performance Standards, an ENC dataset being used in an ECDIS must also have an ENC updating service providing the most current information. The service permits the ENC and the SENC to be corrected for the intended voyage, and thus achieves an important component of SOLAS compliance..

An ENC updating profile is contained within the IHO S-57 Edition 3.0 specification. This enables the efficient addition, removal or replacement of any line, feature, object or area contained within the ENC dataset. Guidance on the means and process for ENC updating is provided in IHO S-52, Appendix 1. In terms of what is called for in the IMO Performance Standards, an ENC dataset being used in an ECDIS must also have an ENC updating service. This permits the ENC and the SENC to be corrected for the intended voyage, and thus achieves an important component of SOLAS compliance.

Within the SENC resides all the information available for the display. The Presentation Library rules such as Standard Display and Display Base define what levels of information from the SENC can be shown. An ENC updating profile is contained within the IHO S-57 Edition 3.0 specification. This enables the efficient addition, removal or replacement of any line, feature, object or area contained within the ENC dataset. Guidance on the means and process for ENC updating is provided in IHO S- 52, Appendix 1. In terms of what is called for in the IMO Performance Standards, an ENC dataset being used in an ECDIS must also have an ENC updating service providing the most current information. The service permits the ENC and the SENC to be corrected for the intended voyage, and thus achieves an important component of SOLAS compliance.

Accordingly, ECDIS must be capable of accepting official updates to the ENC data provided in conformity with IHO standard. Updated cells are stored in a file and transmitted by e-mail, floppy disk or CD-ROM, or satellite. For

example, PRIMAR charts and updates are delivered on two CDs: the Base CD contains the PRIMAR database at the time indicated on the label and the second CD contains the updates for those charts. However, the update CD also contains new charts issued since the base CD was printed. Since the operator must acquire the files and then initiate the update functions of the ECDIS software, this form of updating is referred to as semi-automatic. The two other types of updates include manual and automatic. Manual updating consists of the mariner entering printed NTMs, verbal communication or any other unformatted information. This method requires special attention to the reference-ellipsoid conformity and to conformity of the measurement units and the correction text. Automatic updating consists of updating the SENC through files obtained through electronic data communication lines, such as satellite.

ECDIS will reject updates if the update issuing authority is different from the cell issuing authority. It will also reject corrupted update files and files with an incorrect extension. ECDIS checks that updates are applied in the right sequence. If one update is missing the next update is rejected. An update CD-ROM should contain all available updates for all S-57 cells. Under normal circumstances, ECDIS will automatically run all updates in the right order for all cells.

For S-57 data, the content of updates in text form can be viewed from within the utility that permits the management of chart data. The utility can only be run when ECDIS is terminated. ECDIS is also capable of showing or hiding S-57 updates on a given chart or cell. The update should run via the chart utility. After restarting ECDIS, and after loading into the display the selected chart with the correction, the correction should be manually accepted. That enables the function in S-57 chart options to show or hide the symbol indicating the location of the correction.

NGA DNC Corrections

NGA produces the DNC Vector Product Format Database Update (VDU) to support worldwide DNC navigation requirements of the U.S. Navy, the Military Sealift Command (MSC), the U.S. Coast Guard, and certain foreign partners. Outside US Waters NGA does not distribute DNC to other than U.S. government agencies and foreign governments having data exchange agreements with NGA. The DNC maintenance system is able to apply new source materials such as bathymetry, imagery, Notice to Mariners, local notices, new foreign chart sources, etc. for inclusion in the DNC database. These updates are then provided to the mariner via the VDU process.

The VDU system works by performing a binary comparison of the corrected chart library with the previous latest released baseline edition version. The differences are then written to a binary "patch" file with instructions as to its exact location. The user then applies this patch file by specifying the proper path and filename to their DNC on the

ships ECDIS-N and the data is updated with the VDU patch file. These VDU patch files are cumulative so every new change incorporates all previous changes, so navigators are assured that, having received the latest change, they have all the changes issued to date. The mariner is not required to do weekly incremental updates to apply all the previous update information.

The VDU patch file sizes are small enough to support the bandwidth limitations of ships at sea, and require only one-way communication. The updated patch files are posted every four weeks in groups of seven to eight DNCs per week. The VDU patch files are available as either an individual library patch file, or a full edition patch file to update the whole DNC from the previous edition to the current edition. The DNC VDU patch files are available via the following web locations:

WWW: <https://dnc.nga.mil>

NIPRNET: <https://dnc.geo.nga.mil/NGAPortal/DNC.portal>

SIPRNET: <http://dnc.nga.smil.mil/NGAPortal/DNC.portal>

JWICS: <http://dnc.nga.ic.gov/NGAPortal/DNC.portal>

See Figure 519a for a screen capture from the VDU patch web portal.

A separate layer within DNC provides the user with identification of where changes have been made during the updating process.

British Admiralty Raster and Vector Chart Corrections

The Admiralty Raster Chart Service (ARCS) is the UKHO's paper chart portfolio presented in a digital format. The Admiralty Vector Chart Service (AVCS) is composed of official ENC delivered to industry standards (S-63/S-57) formats and compatible with ECDIS. All ENCs in AVCS satisfy the mandatory chart carriage requirements of SOLAS Chapter V. Both ARCS and AVCS provide worldwide coverage and have weekly online updating services. AN interface guides users through the process of selecting and downloading updates, which can then be transferred to an ECS or ECDIS on CD, DVD or USB memory stick. IN addition to the online update service, weekly CD and DVD update disks provide all the latest *Notice to Mariner* corrections.

NOAA Corrections

In the U.S., NOAA provides updates based on information from USCG, NGA, Canadian Hydrographic Service (CHS) notice to mariners and information that is ready for publication from other sources such as NOAA hydrographic surveys, NOAA shoreline surveys, USACE hydrographic surveys and other features submitted from federal, state and private organizations. Updates are available via the links provided in Figure 519b and Figure 519c.

Commercial Systems

There are a variety of ECS systems available for small

Images

[<Alabama To Texas Approaches>](#)
[<Cuba, Cayman Islands And Jamaica Approaches>](#)
[<Mexico Approaches>](#)
[<South Carolina To Florida Approaches>](#)
[<Coastal Libraries>](#)
[<Alabama To Texas Harbors>](#)
[<Cuba, Cayman Islands And Jamaica Harbors>](#)
[<Mexico Harbors>](#)
[<South Carolina To Florida Harbors>](#)
[<Browse>](#)
[<General Libraries>](#)

Number	Name	Download full library	Download VDU Patch (Windows)	Download VDU Patch (Unix)	Graphic
		<input type="checkbox"/> check all	<input type="checkbox"/> check all	<input type="checkbox"/> check all	
A1508500	Charleston Harbor, South Carolina	<input type="checkbox"/> Edition 036 (2.4 MB)	<input type="checkbox"/> Windows (550.6 KB)	<input type="checkbox"/> Unix (547.7 KB)	n/a
A1508530	Saint Helena Sound, Georgia	<input type="checkbox"/> Edition 036 (3.7 MB)	<input type="checkbox"/> Windows (58.6 KB)	<input type="checkbox"/> Unix (53.7 KB)	n/a
A1508540	Tybee Island to Doboy Sound, Georgia	<input type="checkbox"/> Edition 036 (1.7 MB)	<input type="checkbox"/> Windows (28.7 KB)	<input type="checkbox"/> Unix (23 KB)	n/a
A1508555	Doboy Sound, Georgia	<input type="checkbox"/> Edition 036 (1.5 MB)	<input type="checkbox"/> Windows (2 KB)	<input type="checkbox"/> Unix (1.7 KB)	n/a
A1508580	Saint Augustine, Florida	<input type="checkbox"/> Edition 036 (2.2 MB)	<input type="checkbox"/> Windows (578.7 KB)	<input type="checkbox"/> Unix (545.8 KB)	n/a
A1508595	Cape Canaveral, Florida	<input type="checkbox"/> Edition 036 (1.5 MB)	<input type="checkbox"/> Windows (1.1 MB)	<input type="checkbox"/> Unix (1 MB)	n/a

Figure 519a. DNC website screen capture.



Figure 519b. NOAA ENC Chart Downloader.
<http://www.charts.noaa.gov/ENCs/ENCs.shtml>



Figure 519c. NOAA RNC Chart Downloader.
<https://www.charts.noaa.gov/RNCs/RNCs.shtml>

craft, often found aboard fishing vessels, tugs, research vessels, yachts, and other craft not large enough to need SOLAS equipment but wanting the best in navigation technology. Given that these systems comprise a single navigation aid and do not represent a legal chart in any sense, it is probably not a critical point that correction systems for these products are not robust enough to support regular application of changes.

In fact, often the only way to make changes is to pur-

chase new editions, although the more sophisticated ones allow the placement of electronic “notes” on the chart. The data is commonly stored on RAM chips of various types, and cannot be changed or without re-programming the chip from a CD-ROM or disk containing the data. If the data is on CD-ROM, a new CD-ROM is the update mechanism, and they are, for the most part, infrequently produced. Users of these systems are required to maintain a plot on a corrected paper chart.

USING ELECTRONIC CHARTS

520. Digital Chart Accuracy

As is the case with any shipboard gear, the user must be aware of the capabilities and limitations of digital charts. The mariner should understand that nautical chart data displays possess inherent accuracy limitations. Because digital charts are primarily based on paper charts, many of these limitations have migrated from the paper chart into the electronic chart. Electronic chart accuracy is, for the most part, dependent on the accuracy of the features being displayed and manipulated. While some ECDIS and ECS have the capability to use large-scale data produced from recent hydrographic survey operations (e.g., dredged channel limits or pier/terminal facilities) most raster and vector-based electronic chart data are derived from existing paper charts.

Twenty years ago, mariners were typically obtaining position fixes using radar ranges, visual bearings or Loran. Generally, these positioning methods were an order of magnitude less accurate than the horizontal accuracy of the survey information portrayed on the chart. For example, a three-line fix that results in an equilateral triangle with sides two millimeters in length at a chart scale of 1:20,000 represents a triangle with 40-meter sides in real-world coordinates.

A potential source of error is related to the system configuration, rather than the accuracy of electronic chart data being used. All ECDISs and most ECSs enable the user to input the vessel's dimensions and GPS antenna location. On larger vessels, the relative position of the GPS antenna aboard the ship can be a source of error when viewing the "own-ship" icon next to a pier or wharf.

In U.S. waters, the Coast Guard's DGPS provides a horizontal accuracy of +/-10 meters (95 percent). However, with selective availability off, even the most basic GPS receiver in a non-differential mode may be capable of providing better than 10 meter horizontal accuracy. In actual operation, accuracies of 3-5 meters are being achieved. As a result, some mariners have reported that when using an electronic chart while moored alongside a pier, the vessel icon plots on top of the pier or out in the channel.

Similarly, some mariners transiting a range that marks the centerline of a channel report that the vessel icon plots along the edge or even outside of the channel. Mariners now expect, just as they did 20 years ago, that the horizontal accuracy of their charts will be as accurate as the positioning system available to them. Unfortunately, any electronic chart based on a paper chart, whether it is raster or vector, is not able to meet this expectation.

The overall horizontal accuracy of data portrayed on paper charts is a combination of the accuracy of the underlying source data and the accuracy of the chart compilation process. Most paper charts are generalized composite documents compiled from survey data that have been collected by various sources over a long period of time. A given chart

might encompass one area that is based on a lead line and sextant hydrographic survey conducted in 1890, while another area of the same chart might have been surveyed in the year 2000 with a full-coverage shallow-water multi-beam system. In the U.S., agencies have typically used the most accurate hydrographic survey instrumentation available at the time of the survey.

While survey positioning methods have changed over the years, standards have generally been such that surveys were conducted with a positioning accuracy of better than 0.75 millimeters at the scale of the chart. Therefore, on a 1:20,000-scale chart, the survey data was required to be accurate to 15 meters. Features whose positions originate in the local notice to mariners, reported by unknown source, are usually charted with qualifying notations like position approximate (PA) or position doubtful (PD). The charted positions of these features, if they do exist, may be in error by miles.

In 2002, over 50 percent of the depth information found on U.S. charts is based on hydrographic surveys conducted before 1940. Surveys conducted many years ago with lead lines or single-beam echo sounders sampled only a tiny percentage of the ocean bottom. Hydrographers were unable to collect data between the sounding lines. Depending on the water depth, these lines may have been spaced at 50, 100, 200 or 400 meters. As areas are re-surveyed and full-bottom coverage is obtained, uncharted features, some dangerous to navigation, are discovered quite often. These features were either: 1) not detected on prior surveys, 2) objects such as wrecks that have appeared on the ocean bottom since the prior survey or 3) the result of natural changes that have occurred since the prior survey.

In a similar manner, the shoreline found on most U.S. charts is based on photogrammetric or plane table surveys that are more than 20 years old. In major commercial harbors, the waterfront is constantly changing. New piers, wharves, and docks are constructed and old facilities are demolished. Some of these man-made changes are added to the chart when the responsible authority provides as-built drawings. However, many changes are not reported and therefore do not appear on the chart. Natural erosion along the shoreline, shifting sand bars and spits, and geological subsidence and uplift also tend to render the charted shoreline inaccurate over time.

Another component of horizontal chart accuracy involves the chart compilation process. For example, in the U.S. before NOAA's suite of charts was scanned into raster format, all chart compilation was performed manually. Projection lines were constructed and drawn by hand and all plotting was done relative to these lines. Cartographers graphically reduced large scale surveys or engineering drawings to chart scale. Very often these drawings were referenced to state plane or other local coordinate systems. The data would then be converted to the horizontal datum

of the chart, for example, the North American Datum 1927 (NAD 27) or the North American Datum 1983 (NAD 83). In the late 1980s and early 1990s, NOAA converted all of its charts to NAD 83. In accomplishing this task, averaging techniques were used and all of the projection lines were re-drawn.

When NOAA scanned its charts and moved its cartographic production into a computer environment, variations were noted between manually constructed projection lines and those that were computer generated. All of the raster charts were adjusted or warped so that the manual projection lines conformed to the computer-generated projection. In doing so, all information displayed on the chart was moved or adjusted.

Similar processes take place during NGA's digital chart production, but involving more complexity, since NGA cartographers must work with a variety of different datums in use throughout the world, and with hydrographic data from hundreds of official and unofficial sources. While much of NGA's incoming data was collected to IHO standards during hydrographic surveys, several sources are questionable at best, especially among older data.

Today, when survey crews and contractors obtain DGPS positions on prominent shoreline features and compare those positions to the chart, biases may be found that are on the order of two millimeters at the scale of the chart (e.g., 20 meters on 1:10,000-scale chart). High accuracy aerial photography reveals similar discrepancies between the true shoreline and the charted shoreline. It stands to reason that other important features such as dredged channel limits and navigational aids also exhibit these types of biases. Unfortunately, on any given chart, the magnitude and the direction of these discrepancies will vary by unknown amounts in different areas of the chart. Therefore, no systematic adjustment can easily be performed that will improve the inherent accuracy of the paper or electronic chart.

Some mariners have the misconception that because charts can be viewed on a computer, the information has somehow become more accurate than it appears on paper. Some mariners believe that vector data is more accurate than paper or raster data. Clearly, if an electronic chart database is built by digitizing a paper chart, it can be no more accurate than the paper chart.

Once ENC's are compiled, they may be enhanced with higher accuracy data over time. High resolution shoreline data may be incorporated into the ENC's as new photogrammetric surveys are conducted. Likewise, depths from new hydrographic surveys will gradually supersede depths that originated from old surveys.

521. Route Planning and Monitoring

The *IMO Guidelines for Voyage Planning Res. A.893(21)* state "the development of a plan for voyage or passage, as well as the close and continuous monitoring of

the vessel's progress and position during the execution of such a plan, are of essential importance for the safety of life at sea, safety and efficiency of navigation and protection of the marine environment." The use of ECDIS for route planning automates many navigational processes, from plotting legs between waypoints to the ability to scan the route for navigational hazards based on selected safety parameters and areas for which special conditions exist. The mariner now has greater control with the electronic chart over that of the paper chart with the selection of the display of safe and unsafe water along with other objects in the chart database. Ultimately, the revised *IMO Performance Standards for ECDIS MSC.232(82)* state that "it should be possible to carry out route planning and monitoring in a simple and reliable way."

Route planning with ECDIS takes place before the start of the voyage, except in situations where major changes or deviations in the route are required while the ship is underway. In either case, ECDIS allows the display of both small scale and large scale charts of the operating area and the selection of waypoints from those charts. The determination of the safety contour and safety depth by the mariner, which can be set similar to the minimum depth contour with paper charts, play a critical role during route planning and monitoring (See Section 1002, 1004, and 1018). The safety contour (in ECDIS, the contour related to the own ship, selected by the mariner from the contours provided for in the SENC) is to be used by ECDIS to distinguish on the display between safe and the unsafe water, and for generating anti-grounding alarms.

During route planning with ECDIS as per MSC.232(82):

- An indication is required if the mariner plans a route across an own ship's safety contour.
- An indication should be given if the mariner plans a route closer than a user-specified distance from the boundary of a prohibited area or geographic area for which special conditions exist...
- An indication should also be given if the mariner plans a route closer than a user-specified distance from a point object, such as a fixed or floating aid to navigation or isolated danger.
- It should be possible for the mariner to specify a cross track limit of deviation from the planned route at which an automatic off-track alarm should be activated.

While route or voyage planning encompasses many tasks and has many requirements, the following discussion generally focuses on the use of electronic charts through ECDIS. (Please review Vol I - Chapters 6, 10, 27, and Vol II - Chapter 3 for more detailed discussion on voyage planning.)

Based on the smaller relative size of the ECDIS screen

as compared to equivalent paper charts, the mariner needs to be more accustomed to zooming (increasing or decreasing the chart display scale) and scrolling about the electronic charts during route planning, but must also exercise care to not overuse the zoom function of electronic charts due to overscale and underscale considerations (see Section 501). The mariner has the ability to add, delete, and change the position of waypoints along the route. After the preliminary waypoints have been positioned, the largest scale charts with due regard to the chart's compilation scale are used to further refine the waypoints and resultant legs in between. Additionally, the placement of waypoints should also consider, but not be limited to, traffic patterns and integrated navigation components of visual and radar navigation.

The mariner may need to zoom in and out while reviewing and revising the waypoints along with the resultant route legs. This process should include reviewing the integrity of chart data along with the quality of the bathymetric data of the charts through the display of the category of zone of confidence in data (CATZOC) symbols. The ZOC provides the position and depth accuracy of the ENC cell seafloor coverage, and typical survey characteristics (see Section 428 for more information on ZOC for paper charts).

Accordingly, the accuracy of the areas within the electronic chart may differ from that of GPS/DGPS positioning; therefore, this information, coupled with the CATZOC, will assist in the determination of planned distances off navigational hazards, ECDIS safety settings and other risk management such as routing measures. The horizontal and vertical datum of the chart data must be closely inspected and noted as it may require increased positional cross check procedures. Since planning is normally conducted in advance of the voyage, ECDIS allows for the display of date-dependent objects. This assists the mariner by displaying future changes that may affect a route being planned, provided the new objects are in the database.

When reviewing and refining the position of waypoints, the cross-track distances (XTD) of each leg can be modified to take into consideration safe navigation through the areas of transit ranging from open sea to restricted waterways. The determination of these values should also consider, but not be limited to, ECDIS look-ahead functions through the alarm settings for deviation from route, crossing safety contour, areas with special conditions, indication settings for crossing isolated dangers, along with safe distances from dangers to navigation and other acceptable and approved distance values.

At each waypoint, a wheel over point/line can be displayed to visually indicate when to start a turn. ECDIS typically allows for the mariner to select and display a turn radius for each waypoint. The turn radius is instrumental in the placement and adjustment of waypoints. Accordingly, the mariner must consider at each waypoint involving a change of course whether to use a wheel over based on the advance and transfer calculated from the appropriate turn-

ing circle diagram or a constant radius turn (see Section 1002). The ECDIS also provides the capability for route planning in both straight and curved segments such as rhumb lines and great circles. Depending on the capabilities of the respective ECDIS, the great circle route may require that the route be modified into rhumb line segments based on longitude and limiting latitude requirements (See Section 1206).

When the mariner is satisfied with the planned route, an automatic route check based on appropriate safety values should be conducted. Based on the results of this check, a closer inspection of route details and revisions may be necessary. Notwithstanding the automatic ECDIS route check function, a visual check of the entire route using the largest scale charts should be conducted. The use of the *All Other Information* display, aids the mariner in the display of dangers detected by the route check(s). The systematic and detailed visual check should also consider, but not be limited to, the compilation scale of the charts, alarm parameters, turn radius at each waypoint, critical points and areas along with the reviewing if the route crosses dangers of navigation such as safety contours, isolated dangers, and limits of prohibited and geographical areas for which special purpose areas exist based on the settings of cross-track distances. Upon completion of the visual check and after any route modifications, additional follow-up route checks should then be completed until the plan is finalized and approved.

ECDIS also provides the capability for creating schedules based on values such as ETD, speed, time zone and ETA. Scheduling features can vary among ECDIS manufacturers but ultimately allow for assisting in the calculations for speed of advance and safe speed(s) at various points along the route.

The ship's master should review, revise if necessary, and approve the ECDIS route prior to departure. The route should be saved according the bridge procedures or company policy onboard and properly annotated with any safety-related settings and other pertinent information.

After route planning is complete and prior to departure, the chart display should be set up for underway use to minimize clutter while balancing the need for information to maintain safe navigation. This could require the mariner to carefully select between the *Standard Display* and the on-demand features of the *All Other Information* display based on open sea and restricted waterway/pilotage requirements. Various members of the bridge team will be viewing the ECDIS for different navigational purposes such as route monitoring, looking ahead, and target tracking/monitoring. Accordingly, it must be set up to convey information that is useful and relevant for each bridge team member.

The ECDIS also allows for the display alternate routes as long as the monitored route is clearly distinguishable from the planned routes. The alternate routes display separate routes or passages that can be planned in advance and checked through both automatic and visual methods against

the ship's safety parameters and maneuvering characteristics. For example, alternative routes can be created for contingency or risk management procedures such as deviations or anchorages. See Chapter 10 Piloting and Chapter 41 Weather Routing for more information.

During route monitoring, the ECDIS shows the own ship's position whenever the display covers that area. Although the mariner may choose to "look-ahead" while in route monitoring, it is possible to return to own ship's position with a single operator action. Key information provided during route monitoring includes a continuous indication of vessel position, course, and speed. The display of own ship can be selected by the mariner of either true scale or as a symbol (see Figure 521a and Figure 521b). ECDIS can also provide distance right/left of intended track, planned course and speed to make good, distance to run, position and time of "wheel-over," and past track history.

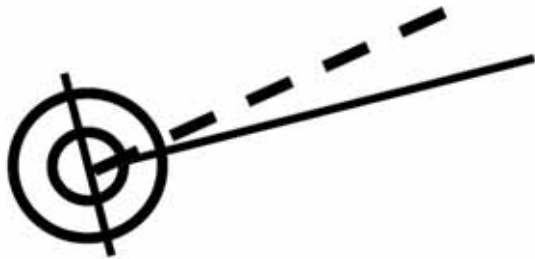

Figure 521a. Example of Own Ship symbol with speed vector (dashed line) and heading line (solid line) From IMO SN.1/Circ. 243/Rev.1 adapted with permission.



Figure 521b. Example of Own Ship True scale outline (symbol) oriented along own ship's heading. From IMO SN.1/Circ. 243/Rev.1 adapted with permission.

When own ship is approaching a waypoint, the mariner may need to zoom in on each waypoint if the chart scale from which it is selected is very small, such that the navigational picture in the area can be seen at a reasonable scale, while being careful not to overscale (Section 501). This can be done either manually or through automated ECDIS features.

To plot the ship's position by alternative means, the ECDIS offers manual position fixing capabilities as defined by MSC.232 (82). The functionality of this feature may

vary based on the ECDIS manufacturer. Manually obtained lines of position (LOP) can span from visual bearings and radar ranges to the input of position(s) calculated through celestial navigation. These positions can then be compared against the position provided by the GPS/DGPS. The ECDIS provides the capability to indicate discrepancies between the manual observations and that of the positions obtained by continuous positioning.

As specified in Appendix 5 of the MSC.232(82) *IMO ECDIS Performance Standards*, the ECDIS must provide an indication of the condition of the system and its components. An alarm must be provided if there is a condition that requires immediate attention. An indication can be visual, while an alarm must be either audible or both audible and visual.

The operator can control certain settings and functions, some of the most important of which are the parameters for certain alarms and indications, including:

- **Crossing safety contour:** As per MSC.232(82), "ECDIS should give an alarm if, within a specified time set by the mariner, own ship will cross the safety contour." The safety contour (shown as an extra thick line for the depth contour) is set to emphasize on the SENC the limits between safe and unsafe water. It is based on the available contours as provided for by the SENC. For example, when the mariner selects two-depth area shades to be displayed, the water deeper than the safety contour is shown in an off-white color while the water shallower than the safety contour is blue when using the day display mode (see Figure 521c).

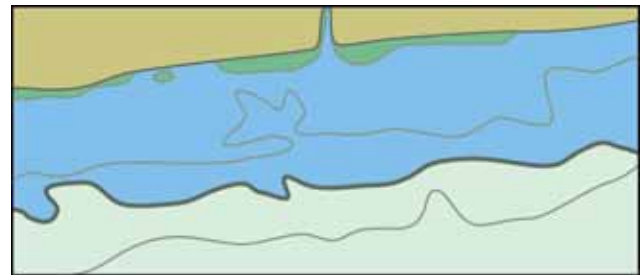

Figure 521c. Portrayal of depth areas with 2-color settings. Image courtesy of NOAA.

- **Area with special conditions:** As per MSC.232(82), "ECDIS should give an alarm or indication, as selected by the mariner, if, within a specified time set by the mariner, own ship will cross the boundary of a prohibited area or of a geographical area for which special conditions exist..." The areas for which special conditions exist are contained within Appendix 4 of MSC.232(82).
- **Deviation from route:** As per MSC.232, "An alarm should be given when the specified cross track limit

for deviation from the planned route is exceeded.” The value is determined as part of route planning, and is the distance to either side of the route leg that the vessel is allowed to deviate before an alarm sounds.

- **Approach to critical point:** The ECDIS provides an alarm when the own ship will be within a specified time or distance to a critical point on the planned route. This alarm can be used for advanced notice of approaching a waypoint or based on a user added point, line, or area.
- **Different geodetic datum:** If the geodetic system used by the positioning system is not the same as the SENC, the ECDIS should give an alarm.
- **Isolated Dangers:** ECDIS can display small shoals, wrecks, rocks and other obstructions with a special symbol, different from their paper chart equivalents. The *Isolated Danger* symbol (see Figure 521d) is displayed to indicate dangers to navigation of a depth equal to or less than the safety contour and also lying within the 'safe' water defined by the safety contour. As per MSC.232(82), “an indication should be given to the mariner if, continuing on its present course and speed, over a specified time or distance set by the mariner, own ship will pass closer than a user-specified distance from a danger (e.g., obstruction, wreck, rock) that is shallower than the mariner's safety contour or an aid to navigation.” It may also be displayed as selected by the mariner in the “unsafe” water between the displayed safety contour and zero meter contour. Additionally, the symbol will be displayed if the depth of the navigational danger is unknown.



Figure 521d. Isolated danger symbol. Image courtesy of NOAA.

The pick report or cursor picking of the ECDIS should be used to determine additional information about it and whether the danger might impact the safe navigation of the vessel. (For more information about the display of this symbol and that of other ENC data on ECDIS as specified by the IHO, consult *U.S. Chart No 1*, available online via the links provided in Figure 521e below.

Other settings that will affect the display of the electronic chart as compared to the paper chart include:

- **Safety depth:** This setting allows for soundings of equal to or less than the mariner-inputted safety



Figure 521e. U.S. Chart No. 1.

https://msi.nga.mil/NGAPortal/MSI.portal?_nfpb=true&_st=&_pageLabel=msi_portal_page_62&pubCode=0004

depth value to be made more conspicuous than deeper soundings. Therefore, the mariner can use the safety depth setting to provide crucial depth information while sailing in proximity to and between the available contours (see Figure 521f). When using the safety depth feature the mariner is reminded that spot soundings are not included in the *Display Base* and *Standard Display*.



Figure 521f. This image shows depth labels (with a light “halo” to set them apart) and soundings both deeper and shallower than the safety depth. Image courtesy of NOAA.

- **Four shades:** a shallow and deep contour, which defines additional depth areas for medium-deep and medium-shallow water can be selected by the mariner to add further detail to the chart display. This chart setting is useful during confined waterway transits such as harbor and coastal areas by providing

enhanced awareness of the gradient of depth area.

- **Shallow Contour:** This setting is usually set as the own ship's deep draft (plus calculated squat) to emphasize the contour shallower than the safety contour.
- **Deep Contour:** This setting is normally set to twice to ship's deep draft (plus calculated squat) to indicate areas where the vessel may experience squat.

When the four shades option is selected, the safety contour is displayed between the medium deep and medium shallow contours. Similar to the safety contour, if the SENC in use does not have a contour line equal to the selected shallow or deep contour, the ECDIS will default to the next deeper contour. Consequently, the mariner should carefully inspect the contour intervals and sounding data to determine the impact on the safe navigation of the vessel. See Figure 521g.

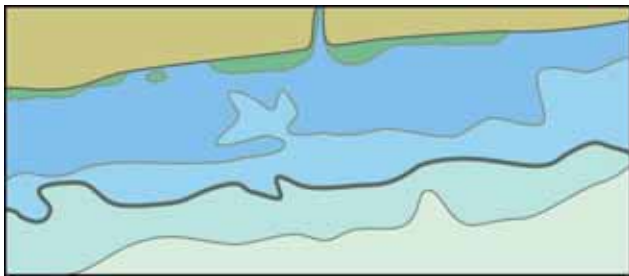

Figure 521g. Portrayal of depth areas with 4-color setting.
Image courtesy of NOAA.

- **Areas Boundaries (Plans and Symbolized):** Because the ECDIS screen is smaller than the equivalent paper chart, the density of data must be considered. The plain area boundaries are intended for use at smaller scales as they can reduce the overall clutter of the charts against the backdrop of the other charted symbols. Symbolized area boundaries can be used on larger scales for display to aid in the identification of areas.
- **Chart Symbols (Paper and Symbolized Point Symbols):** The selection of the chart symbols is the preference of the mariner based on operational considerations. The traditional symbols for point objects are most similar to paper chart symbols. See Figure 506b.

522. Waypoints and Routes

In the route planning mode, the ECDIS allows the entry of waypoints alphanumerically as coordinates of latitude and longitude or the selection of waypoints by moving a cursor around on the charts. It allows the creation

and storage of numerous pre-defined routes, which can be combined in various ways to create complex voyages (review Chapter 27 Navigation Processes).

Routes created from berth to pilot station (or pilot station to berth) should also take into account the maneuvering characteristics of the vessel in restricted and/or confined waterways (review Chapter 10 Piloting). Turn radius used at each waypoint must be closely inspected to insure acceptable clearance throughout the turn with reference to "unsafe" water and other dangers to navigation. During these transits, depending on the availability of contour intervals in the SENC, the mariner with the display of the safety depth has the ability to add additional no-go areas with the mariner's navigational objects or user chart function. Additionally, notes and features can include: Ship Reporting Systems, VTS call-in points, speed limits, expected traffic areas, clearing bearings, DR and EP positions, etc., along with contingency plans such as anchorages, abort and point(s) of no-return.

Coastal and open sea routes can be developed using the vessel's characteristics for route monitoring in addition to using autopilot along with track control (if fitted) considerations. Depending on the sophistication of the autopilot system and integration with other bridge equipment, some ECDIS units, in conjunction with GPS, compare the ship's observed position with that of the intended leg. The units with proper weather, rudder and rate of turn settings then determine the level of compensation for wind and current to ensure the heading and COG are appropriate to maintain the ship on track. The cross-track distance may be set to consider the vessel's operating procedures concerning leeway and course XTD allowance. Berth to sea buoy and coastal/open sea routes can be combined or linked with the ECDIS to establish integrated routes from berth to berth. Route checking and scanning procedures still apply to the newly created route to insure that the routes linked at the appropriate waypoint and other safety settings are considered as discussed in Section 521.

Company procedures regarding **cyber-security** will normally apply to the transferring of data between ECDIS and other computers with internet access. Virus scanning of USBs and other approved media along with the organization of update and route files in paramount. Route files and user chart/notes should be saved and backed up to external media to help insure availability in the event of ECDIS malfunction, failure, transfer to backup system and after a restart/reboot. Based on the individual ECDIS manufacturer, the options for adding notes and descriptions to each saved route can vary. Naming conventions for route names differ based on the operational procedures but can include voyage number, UN/LOCODE for ports, and current year. For example, a voyage between San Francisco and Honolulu could be named 17Voy1USSFOtoUSHNL.

Regardless of whether the route is planned for confined/restricted waterways or open sea, each plan must take into account the principles of safe navigation (review Chap-

ter 10, 27, and in Vol II - Chapter 3).

523. Training and Simulation

The STCW Code as amended in 1995 first introduced the concept of ECDIS being considered within the term “charts.” The 2010 Manila Amendments to the STCW further revised the ECDIS training requirements, which are included in Tables A-II/1, A-II/2 and A-II/3. The training and assessment in the operational use of ECDIS should also conform to revised guidelines as defined by Table B-I and B-II assessment in navigational watchkeeping and evaluation of competence of the STCW Code. Specifically, the 2010 amendments added ECDIS competency requirements for chief mates, masters and officers in charge of a navigational watch on vessels 500 gross tons (GT) or more.

The current curriculum guidance for USCG course approval of ECDIS states the “course should be at least 35 hours and be substantially similar to IMO Model Course 1.27 The Operational Use of the Electronic Chart Display and Information System (ECDIS) (2012 Edition).” The course should also include the “applicable assessments of competence for STCW endorsements for Officer in Charge of a Navigational Watch (OICNW) and Chief Mate and Master.” The ECDIS course should include the Table A-II Column 1 Competencies, which also contains Column 2 Knowledge, Understanding and Proficiency components:

- Knowledge of the capability and limitations of ECDIS, and sub-topics 1 through 3
- Proficiency in the operation, interpretation, and analysis of information obtained from ECDIS, and subtopics 1 through 6
- Management of operational procedures, system files and data, and subtopics 1 through 7

Current training requirements for mariners on ECDIS-equipped vessels includes both generic and familiarization components. The generic training currently follows the ECDIS IMO Model Course 1.27 (2012) Edition. The ECDIS course is typically designed to emphasize the application and learning of ECDIS in the underway context. There are five primary stages of the ECDIS Course:

1. Elements of ECDIS
2. Watchkeeping with ECDIS
3. ECDIS Route Planning
4. ECDIS Charts, Targets & System
5. ECDIS Responsibility

As per Section B-I/12 of the STCW Code, as amended, ECDIS training should be structured to include the theory and demonstration of the principal types of ECDIS and their display characteristics, risks of over-reliance on ECDIS, detection of misrepresentation of information and factors affecting system performance and accuracy. Simulator exercises of the ECDIS training further demonstrate

and, through practical opportunities, allow the trainee to attain knowledge and skills in the setup and maintenance of display, operational use of electronic charts, route planning, route monitoring, alarm handling, manual correction of a ship's position and motion parameters, records in the ships' log, chart updating, operational use of ECDIS where radar/ARPA is connected, operational use of ECDIS where AIS is connected, operational warnings, their benefits and limitations, and system operational tests.

The training requirements for the use of the ECS to meet US domestic paper chart requirements are currently found in Navigation and Vessel Inspection Circular (NVIC) 01-16 as follows:

- “RTCM class 'A' training is met through the successful completion of a USCG-Approved ECDIS course and having an the appropriate endorsement on their Merchant Mariner Credential (MMC)
- “RTCM class 'B' and 'C' training is through the familiarization requirement of 46 CFR 15.405. As per NVIC 01-16, this familiarity can be accomplished through the company following the manufacturer's standards, user's manuals, and company policies to document competency.

While ECDIS can be viewed from a standardized perspective due to the IMO Performance Standards and other IHO and IEC requirements, individual manufacturers have some degree of freedom in their menu structure and terminology used for required functions. This particular aspect and specific installations underlies the need for familiarization to specific ECDIS equipment. Additionally, familiarization with the ECDIS should include reviewing the backup arrangements, sensors and related peripherals. Conversely, generic training in ECDIS has a broader focus on the theory and operational use of ECDIS in the context of navigation.

Familiarization requirements follow STCW Regulation A-I/14 Responsibilities of Companies, International Safety Management (ISM) 6 Resources and Personnel 6.3, 6.5 and 46 CFR 15.405.

Due to advances in navigational technologies, mariners are encouraged to consult USCG, IMO, IHO and manufacturer websites to stay abreast of electronic chart and ECDIS developments. Links to additional information are provided in Figure 523a, Figure 523b and Figure 523c.

524. Reference Note

Material from relevant IHO publications and standards is reproduced with the permission of the International Hydrographic Bureau (IHB), acting for the International Hydrographic Organization (IHO), which does not accept responsibility for the correctness of the material as reproduced: in case of doubt, the IHO's authentic text shall prevail.



Figure 523a. USCG - Navigation Center
<http://www.navcen.uscg.gov/>.



Figure 523b. NOAA Nautical Charts.
<https://www.nauticalcharts.noaa.gov/index.html>



Figure 523c. IHO homepage. Select the ENC's, ECDIS & S-100 tab for more information.
<https://www.iho.int/srv1/index.php?lang=en>

525. References

International Hydrographic Organization. (2007). *Hydrographic Dictionary*. Vol. 1. Special Publication No.32 Appendix 1. Glossary of ECDIS Related Terms. Retrieved from:
https://www.iho.int/iho_pubs/standard/S-32/S-32_App1_English.pdf

International Hydrographic Organization. (2009). *IHO*

transfer standard for digital hydrographic data. Publication S-57 Supplement No. 2.

International Hydrographic Organization. (2010). *Specification for chart content and display aspects of ECDIS*. Publication S-52 Edition 6.0. Retrieved from:
https://www.iho.int/iho_pubs/standard/S-52/S-52_e6.0_EN.pdf

International Hydrographic Organization. (2014). *Specification for chart content and display aspects of ECDIS*. Publication S-52. Edition 6.1.0. Retrieved from:
http://www.iho.int/iho_pubs/standard/S-52/S-52_Edition_610_Oct2014.pdf

International Hydrographic Organization. (2014). *IHO transfer standard for digital hydrographic data*. Publication S-57. Supplement No. 3.

International Maritime Organization. (1991). *General requirements for shipborne radio equipment forming part of the global maritime distress and safety system (GMDSS) and electronic navigational aids*. (Resolution A.694(17)).

International Maritime Organization. (1995). *Performance standards for electronic chart display and information systems (ECDIS)*. Resolution A.817 (19).

International Maritime Organization. (1995). *Code on alarms and indicators, 1995*. Resolution A.830(19).

International Maritime Organization. (2000). *Guidelines for voyage planning*. Resolution A.893(21).

International Maritime Organization. (2004). MSC.191(79). *Performance standards for the presentation of navigational related information on shipborne navigational display*.

International Maritime Organization. (2004). SN/Circ.244. *Guidance on the use of the UN/LOCODE in the destination field in AIS Messages*. Retrieved from:
http://www.navcen.uscg.gov/pdf/nais/imo_sn_circ244_ais_unlocode.pdf

International Maritime Organization. (2006). *Adoption of the revised performance standards for electronic chart display and information systems (ECDIS)*. (2006, December 5). MSC.232 (82). Retrieved from:
http://www.navcen.uscg.gov/pdf/marcomms/imo/msc_resolutions/MS232.pdf

International Maritime Organization. (2007). *Adoption of the revised performance standards for integrated navigation systems (INS)*. (2007, October 8). MSC.252(83). Retrieved from:

http://www.navcen.uscg.gov/pdf/marcomms/imo/msc_resolutions/MSC252.pdf

International Maritime Organization (2010). Code on alerts and indications, 2009. (2009, December 2). Resolution A.1021(26).

International Maritime Organization. (2011). International Convention on Standards of Training, Certification, and Watchkeeping for Seafarers. 2011 ed. London: International Maritime Organization.

International Maritime Organization. (2012). Model Course 1.27. *Operational use of electronic chart display and information systems (ECDIS)* 2012 Edition. London: International Maritime Organization.

International Maritime Organization. (2014). ISM Code. *International safety management code with guidelines for its implementation*. 2014 Edition. London: International Maritime Organization.

International Maritime Organization. (2014). *Amended guidelines for the presentation of navigation-related symbols, terms and abbreviations*. SN/Circ.243/Rev.1. Retrieved from:
http://www.navcen.uscg.gov/pdf/ais/IMO_SN-Circ243_2014_05_Rev_1.pdf

International Maritime Organization. (2015). *ECDIS - Guidance for good practice*. MSC.1/Circ. 1503.

(NOAA, n.d.) National Oceanic and Atmospheric Administration. NOAA Warns Mariners of Serious Display Issue with ECDIS. Retrieved from:
<http://www.nauticalcharts.noaa.gov/staff/headline-ecdis-issue.html>

United States Coast Guard. (2012). *Guidance on issuance of endorsements and approval of training to meet the 2010 amendments to the international convention on standards of training, certification, and watchkeeping for seafarers, 1978, as amended (STCW)*. CG-CVC Policy Letter No. 12-07. Retrieved from:
<https://www.uscg.mil/nmc/regulations/policy/12-07.pdf>

United States Coast Guard. (2014). *Guidelines for approval of training courses and programs*. Navigation and Vessels Inspection Circular No. 03-14. Retrieved from:

https://www.uscg.mil/hq/cg5/nvic/pdf/2014/nvic-03-14_Course_Approval_Final_with_encls20140122.pdf

United States Coast Guard. (2014). *Guidelines on qualifications for STCW endorsements of master or chief mate on vessels of 3,000 GT or more (management level)*. Navigation and Vessel Inspection Circular no. 10-14. Retrieved from:

https://www.uscg.mil/hq/cg5/nvic/pdf/2014/nvic-10-14_master_and_chief_mate_3000_gt_or_more-signed_28APR14.pdf

United States Coast Guard. (2014). *Guidelines on qualifications for STCW endorsements of master or chief mate on vessels of 500 GT or more and less than 3,000GT (management level)*. Navigation and Vessel Inspection Circular no. 11-14. Retrieved from:

https://www.uscg.mil/hq/cg5/nvic/pdf/2014/nvic-11-14_master_and_chief_mate_500-3000_gt-signed_28apr14.pdf

United States Coast Guard. (2014). *Guidelines on qualifications for STCW endorsements as officer in charge of a navigational watch on vessels of 500 GT or more*. Navigation and Vessel Inspection Circular No. 12-14. Retrieved from:

<https://www.uscg.mil/hq/cg5/nvic/pdf/2014/nvic-12-14.pdf>

United States Coast Guard. (2014). *Guidelines on qualifications for STCW endorsements of master or officer in charge of a navigational watch of vessels of less than 500GT limited to near-coastal waters*. Navigation and Vessel Inspection Circular no. 13-14. Retrieved from:
https://www.uscg.mil/nmc/regulations/NVIC/NVIC_2014/nvic_13-14_oicnw_less_than_500_gt-signed_28apr14.pdf

United States Coast Guard. (2016). *Use of electronic charts and publications in lieu of paper charts, maps, and publication*. Navigation and Vessel Inspection Circular No. 01-16. Retrieved from:

https://www.uscg.mil/hq/cg5/nvic/pdf/2016/NVIC_01-16_electronic_charts_and_publications.pdf

United Kingdom Hydrographic Office. (2016). *Guide to ECDIS Implementation, Policy and Procedures*. 2nd Edition. NP232.

CHAPTER 6

NAUTICAL PUBLICATIONS

INTRODUCTION

600. Publications

The navigator uses many textual information sources to plan and conduct a voyage. These sources include notices to mariners, summary of corrections, sailing directions, light lists, tide tables, sight reduction tables, and almanacs.

While it is still possible to obtain hard-copy or printed nautical publications, increasingly these texts are found on-line or in other digital formats, including Compact Disc-Read Only Memory (CD-ROM's) or Digital Versatile Disc (DVD's). Digital publications are much less expensive than printed publications to reproduce and distribute, and online publications have no reproduction costs at all for the producer, and only minor costs to the user. Also, one DVD can hold entire libraries of information, making both distribution and on-board storage much easier.

The advantages of electronic publications over hard-copy go beyond cost savings. They can be updated easier and more often, making it possible for mariners to have frequent or even continuous access to a maintained publications database instead of receiving new editions at infrequent intervals and entering hand corrections periodically. Generally, digital publications also provide links and search engines affording quick access to relevant information.

Navigational publications are available from many sources. Military customers automatically receive or requisition most publications. The civilian navigator obtains publications from a publisher's agent. Larger agents representing many publishers can completely

supply a ship's chart and publication library. On-line publications produced by the U.S. government are available on the Web.

601. Maintenance and Carriage Requirements of Navigation Publications

Vessels may maintain the navigation publications required by Title 33 of the Code of Federal Regulations Parts 161.4, 164.33, and 164.72 and SOLAS Chapter V Regulation 27 in electronic format provided that they are derived from the original source, are currently corrected/up-to-date, and are readily accessible on the vessel's bridge by the crew. Adequate independent back-up arrangements shall be provided in case of electronic/technical failure. Such arrangements include: a second computer, CD, or portable mass storage device readily displayable to the navigation watch, or printed paper copies.

Since most required publications are only available in electronic format, the U.S. Coast Guard considers electronic publications of the U.S. Coast Pilots, U.S. Coast Guard *Light Lists*, *NGA Sailing Directions*, *NGA List of Lights*, tide-current and river-current tables, *Local Notice to Mariners*, *Notice to Mariners*, *Notices to Navigation Interests*, and *Vessel Traffic Service Rules* to be an acceptable equivalent means of meeting the publication carriage requirements set forth in Titles 33 and 46 of the Code of Federal Regulations and SOLAS Chapter V Regulation 27.

NAUTICAL TEXTS

602. *Sailing Directions*

National Geospatial-Intelligence Agency (NGA) *Sailing Directions* consist of 37 *Enroutes* and 5 *Planning Guides*. *Planning Guides* describe general features of ocean basins; *Enroutes* describe detailed coastal and port approach information designed to supplement the largest scale charts produced by the NGA.

The *Sailing Directions (Planning Guides)* are relatively static; however, by contrast, *Sailing Directions (Enroute)* are frequently updated.

603. *Sailing Directions (Planning Guide)*

Planning Guides assist the navigator in planning an extensive oceanic voyage. Each of the Guides provides useful information about all the countries adjacent to a particular ocean basin. The limits of the *Sailing Directions* in relation to the major ocean basins are shown in Figure 603b.

Planning Guides are a series of five regional volumes, structured in the alphabetical order of countries contained within the region. Information pertaining to each country includes Buoyage Systems, Currency, Government, Industries, Holidays, Languages, Regulations, Firing Danger



Areas, Mined Areas, Pilotage, Search and Rescue, Reporting Systems, Submarine Operating Areas, Time Zone, and the location of the U.S. Embassy.

The entire collection of *Sailing Directions (Planning Guides)* volumes is available online via the link found in Figure 603a.

Figure 603a. *Sailing Directions (Planning Guides)*
https://msi.nga.mil/NGAPortal/MSI.portal?_nfpb=true&_pageLabel=msi_portal_page_62&pubCode=0011

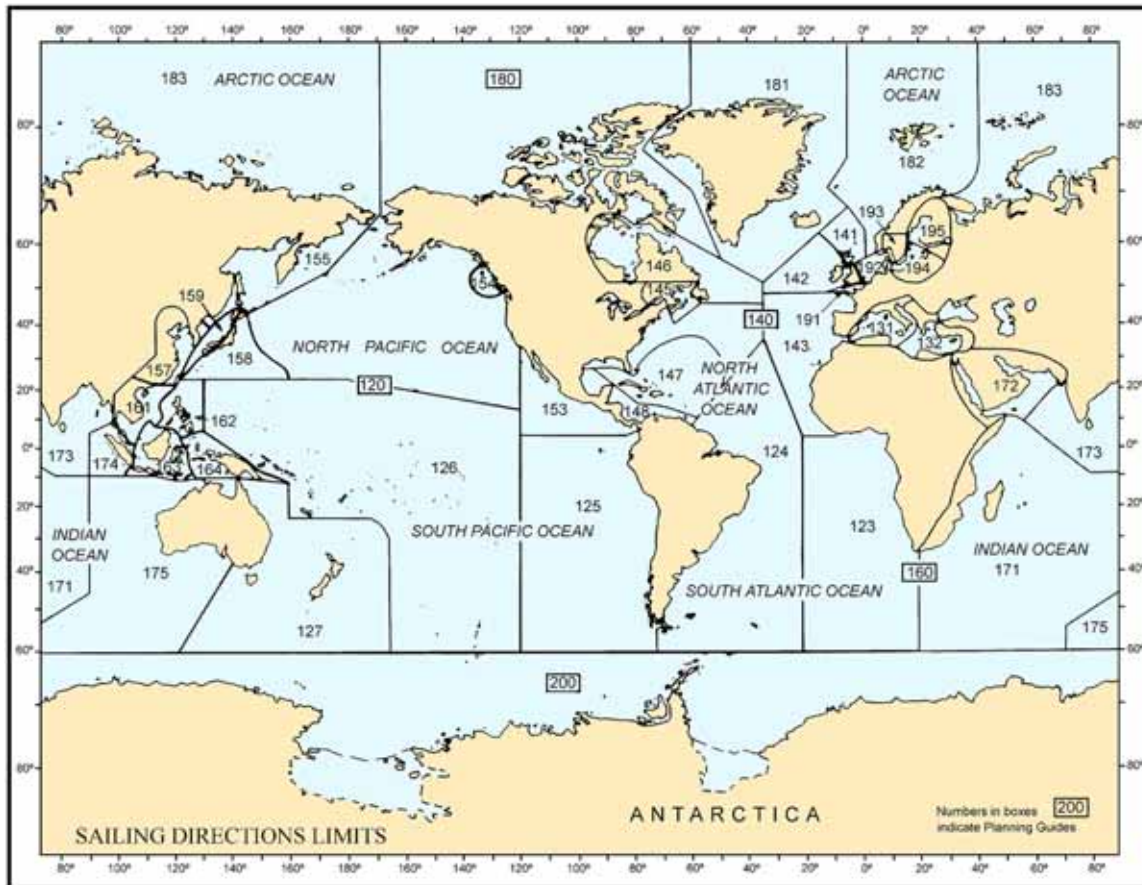

Figure 603b. *Sailing Directions* limits in relation to the major ocean basins.

604. *Sailing Directions (Enroute)*

Sailing Directions (Enroute) publications are a series of 37 volumes organized geographically, and include additional information about coastal and port approach not depicted on nautical charts, including winds, weather, tides, currents, ice, dangers, navigational aids, procedures, regulations, and port facilities. These publications also include some images of navigational aids and port facilities, as well as a graphic key to chart coverage of the region

Each volume of the *Sailing Directions (Enroute)* contains numbered sections along a coast or through a

strait. Figure 604a illustrates this division. A preface with information about authorities, references, and conventions used in each book precedes the sector discussions. Each sector is sub-divided into paragraphs and discussed in turn. Each book provides conversions between feet, fathoms, and meters. A list of abbreviations that may be found in the text follows the conversion tables.

A *Chart Information* graphic and *DNC Library Information* graphic begin each sector. They provide a graphical key for charts (both paper and digital) pertaining to the area. See Figure 604c and Figure 604b. The graduation of the

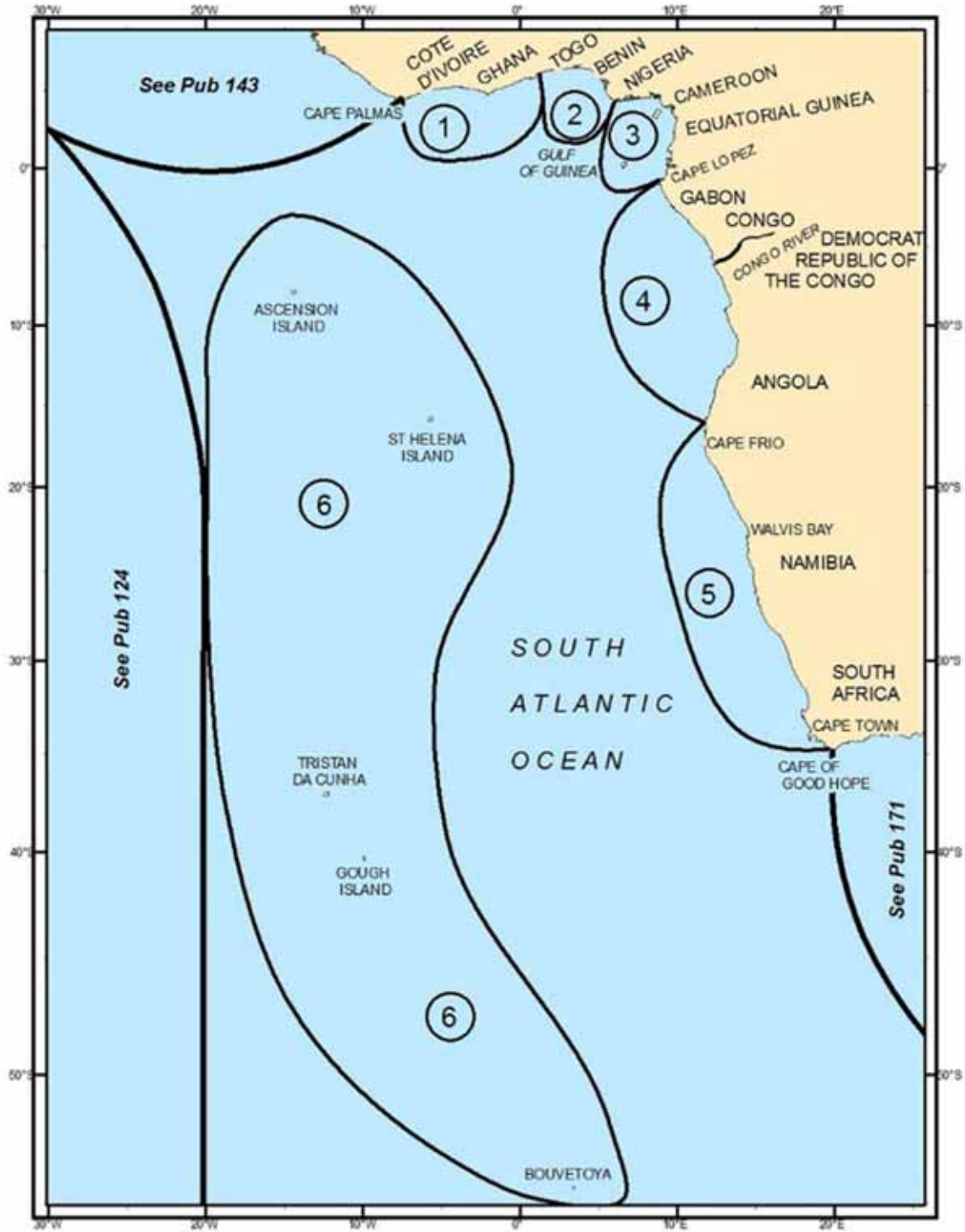

Figure 604a. Example of a typical sector limits graphic.

border scale on each of these graphics enable navigators to identify the largest scale chart or DNC library for a particular location, in addition to identifying features listed in the Index-Gazetteer. These graphics are not maintained by *Notice to Mariners*, therefore, one should refer to the chart catalog for updated chart listings. Other graphics found in the publication may contain special information on anchor-

ages, significant coastal features, and navigation dangers.

A foreign terms glossary and a comprehensive Index-Gazetteer follow the sector discussions. The Index-Gazetteer is an alphabetical listing of described and charted features. The Index lists each feature by geographic coordinates and sector paragraph number.

U.S. military vessels have access to special files of data

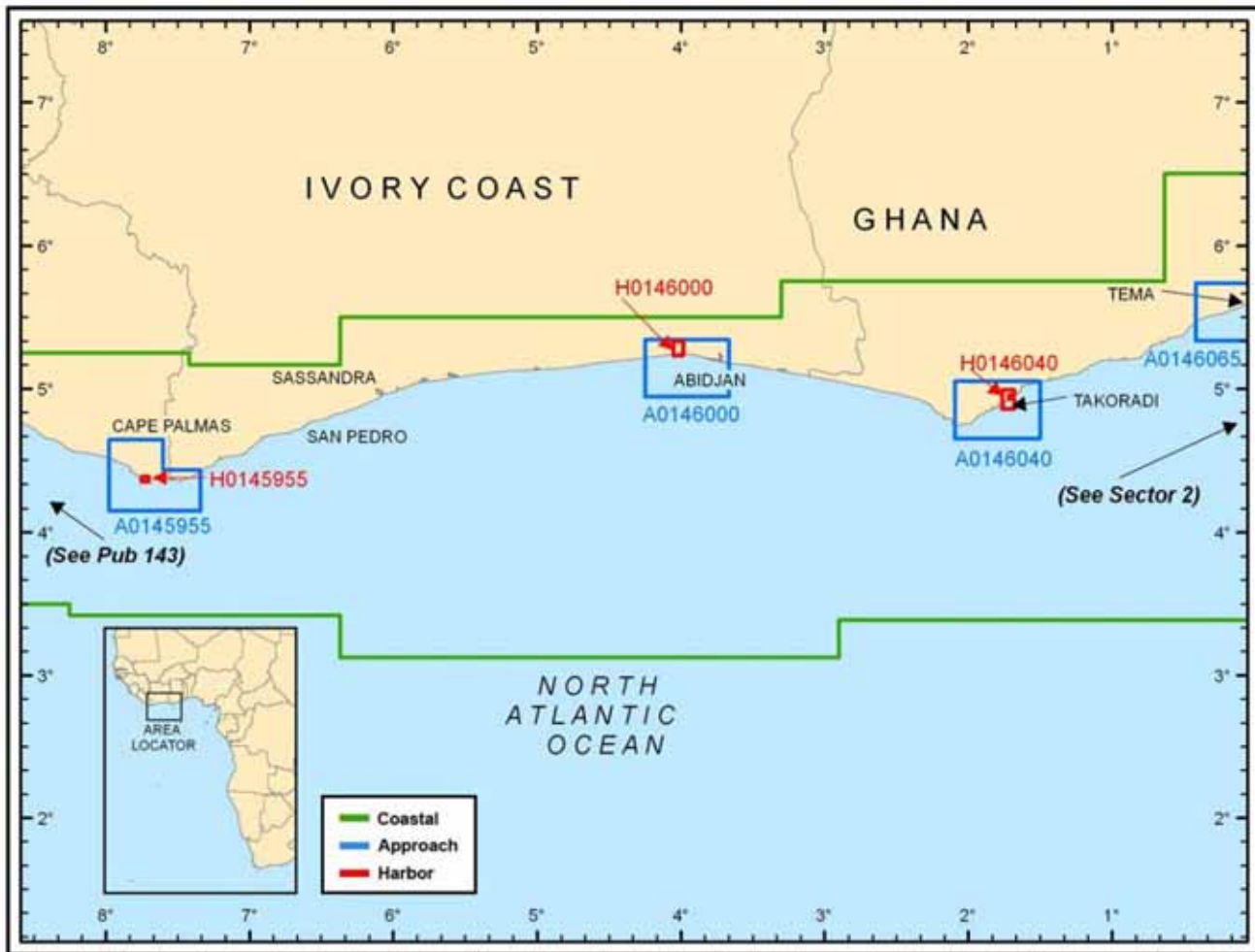

Figure 604b. Library information graphic.

reported via official messages known as Port Visit After Action Reports. These reports, written in text form according to a standardized reporting format, give complete details of recent visits by U.S. military vessels to all foreign ports visited. Virtually every detail regarding navigation, services, supplies, official and unofficial contacts, and other matters are reported in detail, making these documents an extremely useful adjunct to the *Sailing Directions*. These files are available to “.mil” users only, and may be accessed on the Web at: <http://cnsl.spear.navy.mil>, under the “Force Navigator” link. They are also available via DoD’s classified Web.

The entire collection of *Sailing Directions* (Enroute) volumes is available online via the link provided in Figure 604d.

To accommodate customers who experience difficulty accessing the World Wide Web, NGA provides a **Subscription Service** whereby notification of publication updates are delivered via email message to the requesting address. Additionally, subscribers will receive email notifi-

cation when a publication new edition is released. The **Publication Updates Subscription** page may be accessed via the Publications tab on the Maritime Safety Information website.

605. U.S. Coast Pilots

The National Oceanic and Atmospheric Administration (NOAA) publishes nine *U.S. Coast Pilots* to supplement nautical charts of U.S. waters. Information comes from field inspections, survey vessels, and various harbor authorities. Maritime officials and pilotage associations provide additional information. *U.S. Coast Pilots* provide more detailed information than *Sailing Directions* because *Sailing Directions* are intended exclusively for the oceangoing mariner. The *Notice to Mariners* updates *U.S. Coast Pilots*.

Each volume contains comprehensive sections on local operational considerations and navigation regulations. Following chapters contain detailed discussions of coastal

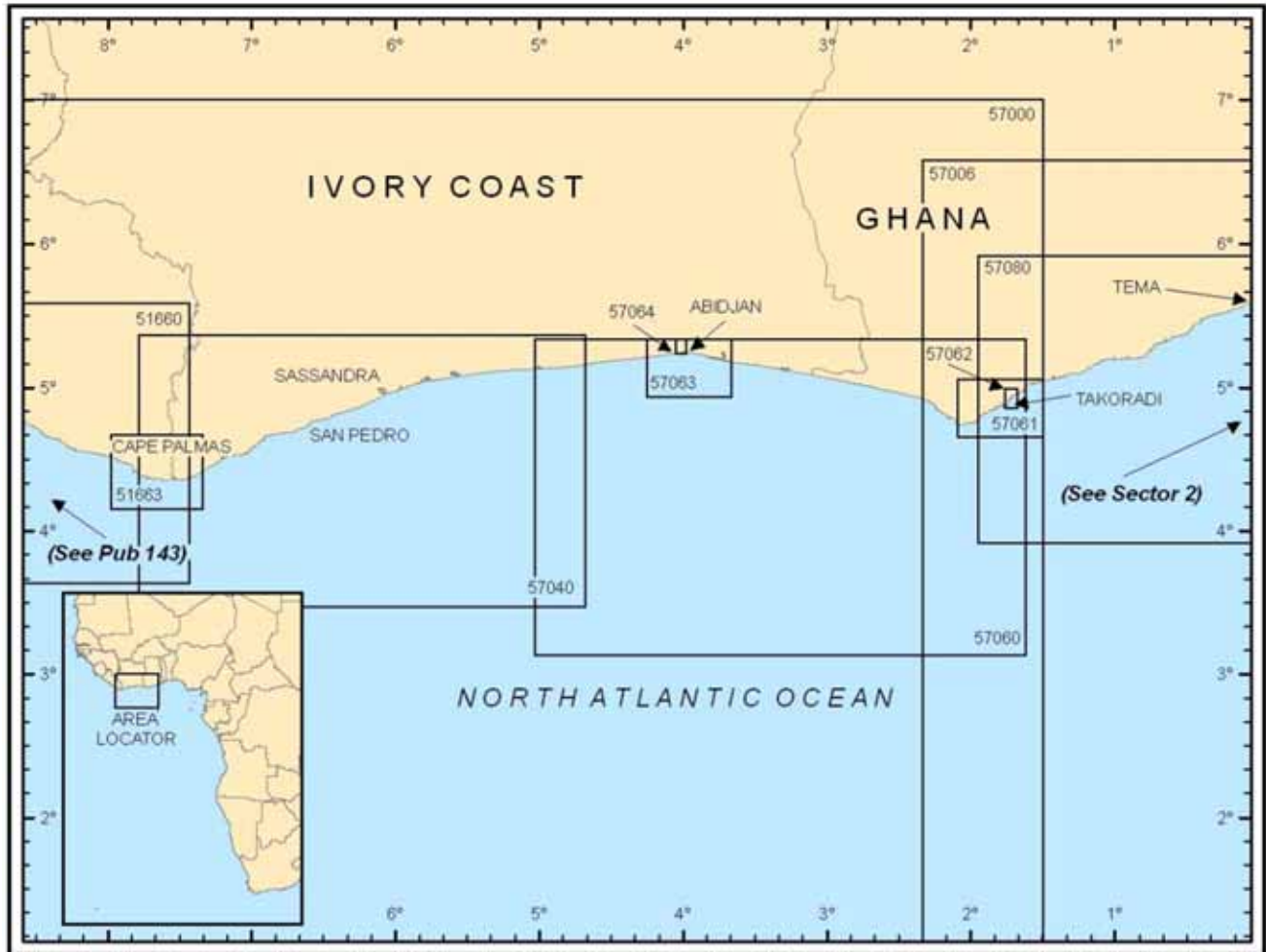

Figure 604c. Chart information graphics depict hardcopy charting boundaries.



Figure 604d. Sailing Directions (Enroute)

https://msi.nga.mil/NGAPortal/MSI.portal?_nfpb=true&_pageLabel=msi_portal_page_62&pubCode=0010

navigation. An appendix provides information for obtaining additional weather information, communications services, and other data. An index and additional tables complete the volume.

The entire collection of *U.S. Coast Pilots* can be found via the link provided in Figure 605.

606. Other Nautical Texts

The federal government publishes several other



Figure 605. U.S. Coast Pilots.

<https://www.nauticalcharts.noaa.gov/nsd/cpdownload.htm>

nautical texts. NGA, for example, publishes *Pub. 1310, Radar Navigation and Maneuvering Board Manual* and *Pub. No. 9, American Practical Navigator*.

The U.S. Coast Guard publishes the *Navigation Rules and Regulations Handbook* for international and inland waters. This publication contains the Inland Navigation Rules enacted in December 1980 and effective on all inland waters of the United States including the Great Lakes, as well as the *International Regulations for the Prevention of Collisions at Sea*, enacted in 1972 (1972 COLREGS).

Mariners underway should ensure that they possess the latest updated issue, which can be found on the Coast Guard's Navigation Center website: <http://www.navcen.uscg.gov/>. The Coast Guard also publishes the *Light Lists*, *Navigation and Vessel Inspection Circulars*; and the *Chemical Data Guide for Bulk Shipment by Water*.

The Government Publishing Office provides several publications on navigation, safety at sea, communications, weather, and related topics. Additionally, it publishes provisions of the Code of Federal Regulations (CFR) relating to maritime matters. In addition to official U.S. publications, there are a number of private publishers also provide maritime publications not referenced herein.

The International Maritime Organization (IMO), International Hydrographic Organization (IHO), and other governing international organizations publish information on international navigation regulations. Regulations for various Vessel Traffic Services (VTS), canals, lock systems, and other regulated waterways are published by the authorities who operate them. Nautical chart and publication sales agents are a good source of information about publications required for any voyage. Increasingly, many regulations, whether instituted by international or national governments, can be found on-line. This includes regula-

tions for VTS, Traffic Separation Schemes (TSS), special regulations for passage through major canal and lock systems, port and harbor regulations, and other information. A Web search can often find the textual information the navigator needs.

Vessel Traffic Services (VTS) are discussed in greater detail in Chapter 29 - Navigation Regulations. The U.S. Coast Guard's Navigation Center (NAVCEN) provides access to detailed information websites and/or user manuals regarding Vessel Traffic Services for twelve VTS locations throughout the United States. A link to the NAVCEN website may be found in Figure 606.



Figure 606. U.S. Coast Guard - Navigation Center.
<https://www.navcen.uscg.gov/?pageName=vtsMain>

USING THE LIGHT LISTS

607. Light Lists

The United States publishes two different light lists. The U.S. Coast Guard publishes the *Light List* for lights in U.S. territorial waters; NGA publishes the *List of Lights* for lights in foreign waters.

Light lists furnish detailed information about navigation lights and other navigation aids, supplementing the charts, *Coast Pilots*, and *Sailing Directions*. Consult the chart for the location and light characteristics of all navigation aids; consult the light lists to determine their detailed description.

The *Notice to Mariners* corrects both lists. Corrections which have accumulated since the print date are included in the *Notice to Mariners* as a *Summary of Corrections*. All of these summary corrections, and any corrections published subsequently, should be noted in the "Record of Corrections."

A navigator needs to know both the identity of a light and when s/he can expect to see it; s/he often plans the ship's track to pass within a light's range. If lights are not sighted when predicted, the vessel may be significantly off course and standing into danger.

A circle with a radius equal to the visible range of the light usually defines the area in which a light can be seen. On some bearings, however, obstructions may reduce the range. In this case, the obstructed arc might differ with height of eye and distance. Also, lights of different colors may be seen at different distances. Consider these facts both

when identifying a light and predicting the range at which it can be seen.

Atmospheric conditions can have a major effect on a light's range. For example, fog, haze, dust, smoke, or precipitation can obscure a light, or a light may even be extinguished. Always report an extinguished light so maritime authorities can issue a warning and make repairs.

On a dark, clear night, the visual range is normally only limited by luminous intensity, or curvature of the Earth. However, regardless the height of eye, one cannot see a weak light beyond its luminous range. Assuming that light travels linearly, an observer located below the light's visible horizon cannot see it. The Distance to the Horizon table gives the distance to the horizon for various heights of eye. The light lists contain a condensed version of this table. Abnormal refraction patterns might change this range; therefore, one cannot exactly predict the range at which a light will be seen.

608. Finding Range and Bearing of a Light at Sighting

A light's **luminous range** is the maximum range at which an observer can see a light under existing visibility conditions. This luminous range ignores the elevation of the light, the observer's height of eye, the curvature of the Earth, and interference from background lighting. It is determined from the known **nominal range** and the existing visibility conditions. The nominal range is the maximum

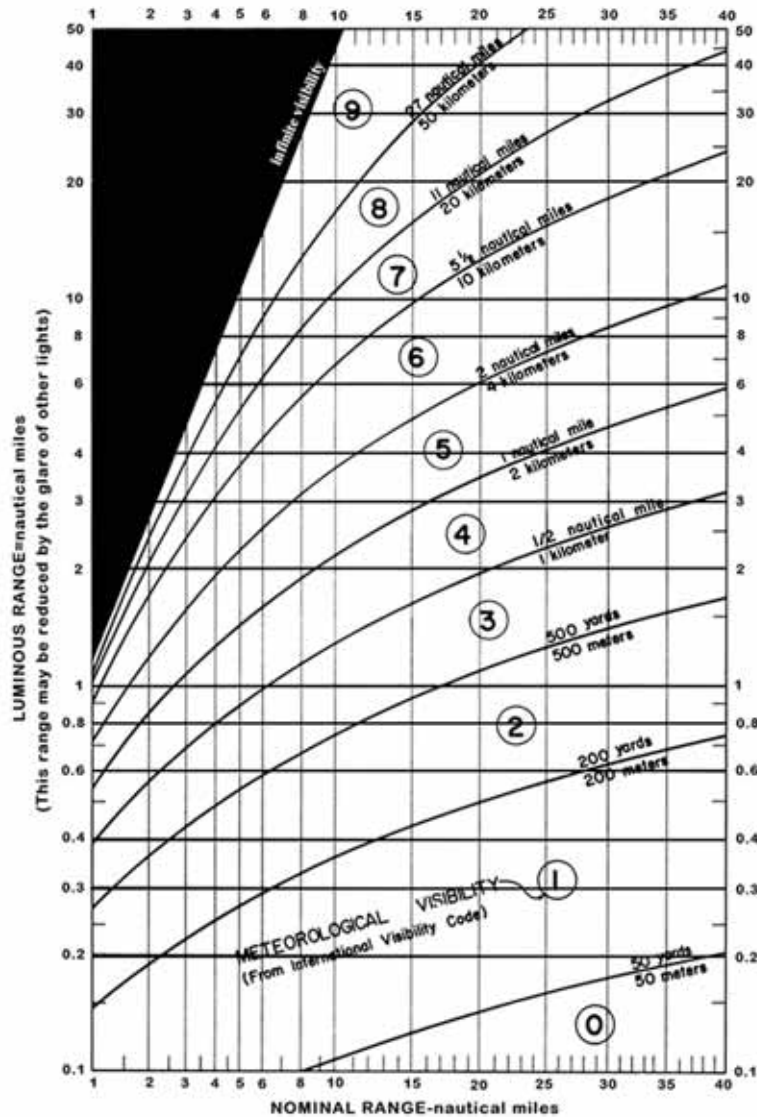

Figure 608a. Luminous Range Diagram.

distance at which a light can be seen in weather conditions where the visibility is 10 nautical miles.

The U.S. Coast Guard *Light List* usually lists a light's nominal range. Use the Luminous Range Diagram shown in the *Light List* and Figure 608a to convert this nominal range to luminous range. Remember that the luminous ranges obtained are approximate because of atmospheric or background lighting conditions. To use the Luminous Range Diagram, first estimate the meteorological visibility by the Meteorological Optical Range Table, See Table 608. Next, enter the Luminous Range Diagram with the nominal range on the horizontal nominal range scale. Follow a vertical line upward until it intersects the curve or reaches the region on the diagram representing the meteorological visibility. Finally, follow a horizontal line from this point or region until it intersects the vertical luminous range scale.

Example 1: The nominal range of a light as extracted from the *Light List* is 15 nautical miles.

Required: The luminous range when the meteorological visibility is (1) 11 nautical miles and (2) 1 nautical mile.

Solution: To find the luminous range when the meteorological visibility is 11 nautical miles, enter the Luminous Range Diagram with nominal range 15 nautical miles on the horizontal nominal range scale; follow a vertical line upward until it intersects the curve on the diagram representing a meteorological visibility of 11 nautical miles; from this point follow a horizontal line to the right until it intersects the vertical luminous range scale at 16 nautical miles. A similar procedure is followed to find the luminous range when the meteorological visibility is 1 nautical mile.

Answers: (1) 16 nautical miles; (2) 3 nautical miles.

Code No.	Weather	Yards
0	Dense fog	Less than 50
1	Thick fog	50-200
2	Moderate fog	200-500
3	Light fog	500-1000
		Nautical Miles
4	Thin fog	1/2-1
5	Haze	1-2
6	Light Haze	2-5 1/2
7	Clear	5 1/2-11
8	Very Clear	11.0-27.0.
9	Exceptionally Clear	Over 27.0

From the International Visibility Code.

Table 608. Meteorological Optical Range.

A light's **geographic range** depends upon the height of both the light and the observer. The sum of the observer's distance to the visible horizon (based on their height of eye) plus the light's distance to the horizon (based on its height) is its geographic range. See Figure 608b. This illustration uses a light 150 feet above the water. Entering Table 13 - *Distance of the Horizon* (in Volume 2), yields a value of 14.3 nautical miles for a height of 150 feet. Within this range, the light, if powerful enough and atmospheric conditions permit, is visible regardless of the height of eye of the observer. Beyond 14.3 nautical miles, the geographic range depends upon the observer's height of eye. Thus, by the Distance of the Horizon table mentioned above, observers with a height of eye of 5 feet can see the light on their horizon if they are 2.6 miles beyond the horizon of the light. The geographic range of the light is therefore 16.9 miles. For a height of 30 feet the distance is $14.3 + 6.4 = 20.7$ miles. If the height of eye is 70 feet, the geographic range is $14.3 + 9.8 = 24.1$ miles. A height of eye of 15 feet is often assumed when tabulating lights' geographic ranges.

To predict the bearing and range at which a vessel will initially sight a light first determine the light's geographic range. Compare the geographic range with the light's luminous range. The lesser of the two ranges is the range at which the light will first be sighted. Plot a visibility arc centered on the light and with a radius equal to the lesser of the geographic or luminous ranges. Extend the vessel's track until it intersects the visibility arc. The bearing from the intersection point to the light is the light's predicted bearing at first sighting.

If the extended track crosses the visibility arc at a small angle, a small lateral track error may result in large bearing and time prediction errors. This is particularly apparent if the vessel is farther from the light than predicted; the vessel may pass the light without sighting it.

However, not sighting a light when predicted does not always indicate the vessel is farther from the light than expected. It could also mean that atmospheric conditions are affecting visibility.

Example 1: The nominal range of a navigational light 120 feet above the chart datum is 20 nautical miles. The meteorological visibility is 27 nautical miles.

Required: The distance at which an observer at a height of eye of 50 feet can expect to see the light.

Solution: The maximum range at which the light may be seen is the lesser of the luminous or geographic ranges. At 120 feet the distance to the horizon, by table or formula, is 12.8 miles. Add 8.3 miles, the distance to the horizon for a height of eye of 50 feet to determine the geographic range. The geographic range, 21.1 miles, is less than the luminous range, 40 miles.

Answer: 21 nautical miles. Because of various uncertainties, the range is rounded off to the nearest whole mile.

When first sighting a light, observers can determine if it is on the horizon by immediately reducing their height of eye. If the light disappears and then reappears when the observer returns to their original height, the light is on the horizon. This process is called **bobbing a light**.

If a vessel has considerable vertical motion due to rough seas, a light sighted on the horizon may alternately appear and disappear. Wave tops may also obstruct the light periodically. This may cause the characteristic to appear different than expected. The light's true characteristics can be ascertained either by closing the range to the light or by increasing the observer's height of eye.

If a light's range given in a foreign publication approximates the light's geographic range for a 15-foot observer's height of eye, one can assume that the printed range is the light's geographic range. Also assume that publication has listed the lesser of the geographic and nominal ranges. Therefore, if the light's listed range approximates the geographic range for an observer with a height of eye of 15 feet, then assume that the light's limiting range is the geographic range. Then, calculate the light's true geographic range using the actual observer's height of eye, not the assumed height of eye of 15 feet. This calculated true geographic range is the range at which the light will first be sighted.

Example 2: The range of a light as printed on a foreign chart is 17 miles. The light is 120 feet above chart datum. The meteorological visibility is 10 nautical miles.

Required: The distance at which an observer at a height of eye of 50 feet can expect to see the light.

Solution: Calculate the geographic range of the light

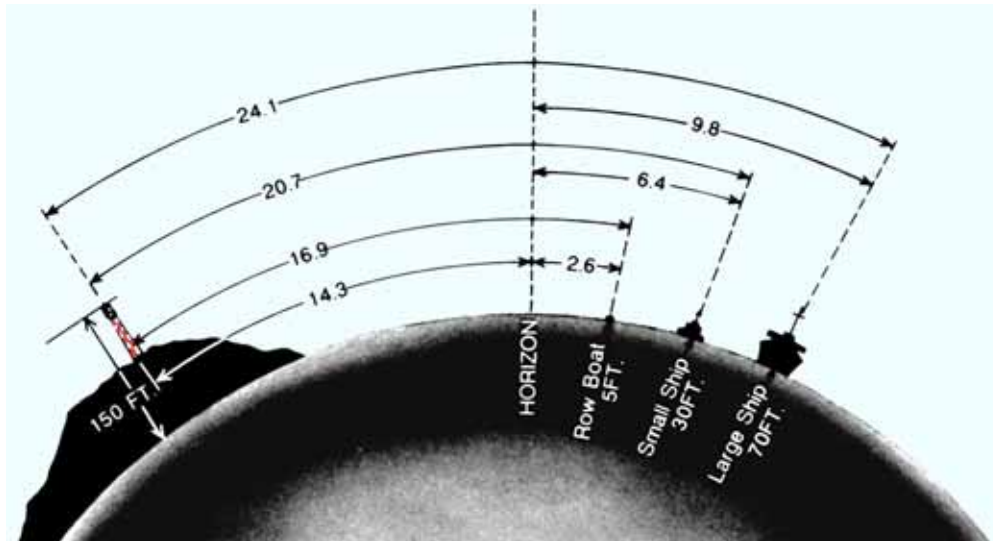

Figure 608b. Geographic Range of a light.

assuming a 15 foot observer's height of eye. At 120 feet the distance to the horizon is 12.8 miles. Add 4.5 miles (the distance to the horizon at a height of 15 feet) to 12.8 miles; this range is 17.3 miles. This approximates the range listed on the chart. Then assuming that the charted range is the geographic range for a 15-foot observer height of eye and that the nominal range is the greater than this charted range, the predicted range is found by calculating the true geographic range with a 50 foot height of eye for the observer.

Answer: The predicted range = 12.8 mi. + 8.3 mi. = 21.1 mi. The distance in excess of the charted range depends on the luminous intensity of the light and the meteorological visibility.

609. USCG Light Lists

The U.S. Coast Guard *Light List* (7 volumes) gives information on lighted navigation aids, unlighted buoys, daybeacons, racons, and the Automatic Identification System (AIS). For a graphical depiction of the limits of each volume, see Figure 609a.

Each volume of the *Light List* contains aids to navigation in geographic order from north to south along the Atlantic coast, from east to west along the Gulf coast, and from south to north along the Pacific coast. It lists seacoast aids first, followed by entrance and harbor aids listed from seaward. Intracoastal Waterway aids are listed last in geographic order in the direction from New Jersey to Florida to the Texas/Mexico border.

The listings are preceded by a description of the aids to navigation system in the United States, luminous range diagram, geographic range tables, and other information.

The entire collection of USCG *Light Lists* can be found

on NGA's Maritime Safety Information website via the link provided in Figure 609b.

610. NGA List of Lights, Radio Aids, and Fog Signals

The National Geospatial-intelligence Agency (NGA) publishes the *List of Lights, Radio Aids, and Fog Signals* (usually referred to as the *List of Lights*, not to be confused with the Coast Guard's *Light List*). In addition to information on lighted aids to navigation and sound signals in foreign waters, the NGA *List of Lights* provides information on storm signals, signal stations, racons, radiobeacons, radio direction finder calibration stations located at or near lights, and DGPS stations. For more details on radio navigational aids, consult *Pub. 117, Radio Navigational Aids*.

The NGA *List of Lights* generally does not include information on buoys, although in certain instances, a large offshore buoy with a radio navigational aid may be listed. It does include certain aeronautical lights situated near the coast. However, these lights are not designed for marine navigation and may be subject to unreported changes.

For a graphical depiction of the limits of each of the seven volumes (*Pub. 110* through *Pub. 116*) of NGA's *List of Lights* see Figure 610a.

Foreign notices to mariners are the main correctional information source for the NGA *List of Lights*; other sources, such as ship reports, are also used. Many aids to navigation in less developed countries may not be well maintained; they are also susceptible to damage by storms and vandalism, and repairs may be delayed for long periods.

The entire collection of NGA *List of Lights* can be found via the link in Figure 610b.

LIMITS OF LIGHT LISTS PUBLISHED BY
U.S. COAST GUARD

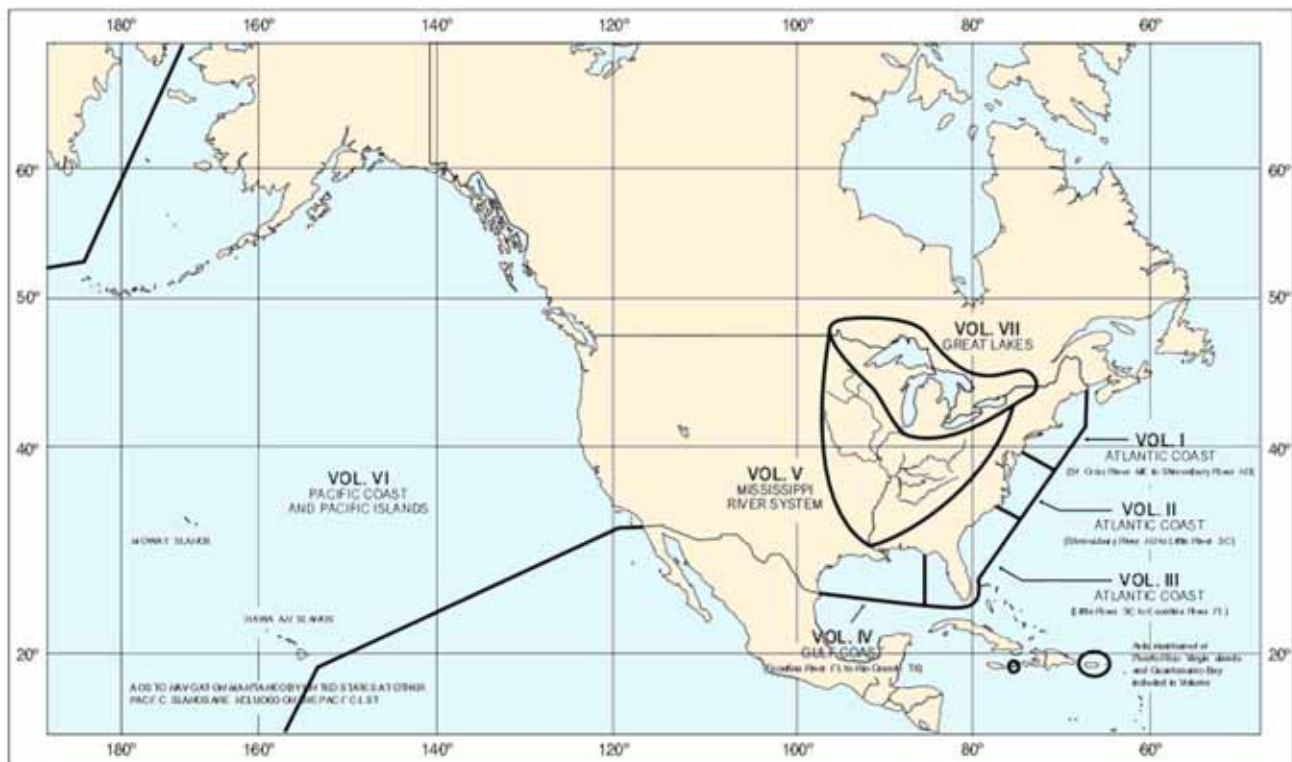

Figure 609a. USCG Light List limits.



Figure 609b. U.S. Coast Guard - Light Lists.

https://msi.nga.mil/NGAPortal/MSI.portal?_nfpb=true&st=&_pageLabel=msi_portal_page_62&pubCode=0014

MISCELLANEOUS NAUTICAL PUBLICATIONS

611. NGA *Radio Navigational Aids* (Pub. No. 117)

This publication is a selected list of worldwide radio stations which perform services to the mariner. Topics covered include radio direction finder and radar stations, radio time signals, radio navigation warnings, distress and safety communications, medical advice via radio, long-range navigation aids, the AMVER system, and interim procedures for U.S. vessels in the event of an outbreak of hostilities. *Pub. No. 117* is corrected via

the *Notice to Mariners* and is updated periodically with a new edition.

Though *Pub. No. 117* is essentially a list of radio stations providing vital maritime communication and navigation services, it also contains information which explains the capabilities and limitations of the various systems.

The online version of *NGA Radio Navigational Aids* (*Pub. No. 117*) can be found via the link in Figure 611.

LIST OF LIGHTS LIMITS
NATIONAL GEOSPATIAL-INTELLIGENCE AGENCY

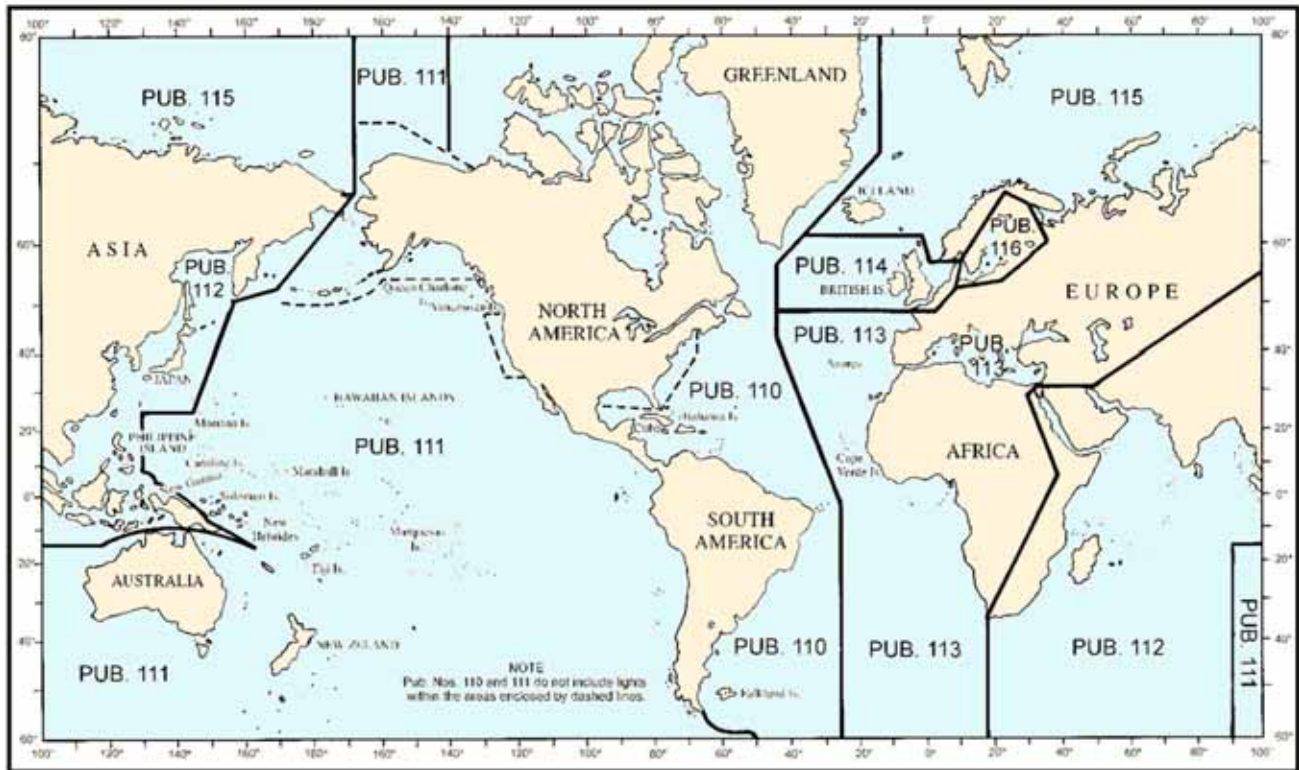

Figure 610a. NGA List of Light limits.

612. Chart No. 1

Chart No. 1 is not actually a chart, but a book containing a key to the symbols, abbreviations, and terms used on nautical charts. Most countries that produce charts also produce such a document. The U.S. *Chart No. 1* contains a listing of chart symbols in five categories:

- Symbols used on NOAA charts
- Symbols used on NGA charts
- Symbols used on foreign charts reproduced by NGA
- Symbols recommended by the International Hydrographic Organization (INT1 symbols)
- Symbols specified for use in ECDIS to display ENCs

Subjects covered include general features of charts, topography, hydrography, and aids to navigation. Several pages are devoted to explaining unique features of ECDIS displays, including color palettes, simplified and “traditional” symbology, and safety contours. There is also a complete index of abbreviations and an explanation of the IALA buoyage system.

Chart No. 1 can be found online via the link in Figure 612.



Figure 610b. NGA- List of Lights.

https://msi.nga.mil/NGAPortal/MSI.portal?_nfpb=true&st=&_pageLabel=msi_portal_page_62&pubCode=0007



Figure 611. NGA- Radio Navigational Aids (Pub. No. 117).

https://msi.nga.mil/NGAPortal/MSI.portal?_nfpb=true&st=&_pageLabel=msi_portal_page_62&pubCode=0009



Figure 612. Chart No. 1.

<https://www.nauticalcharts.noaa.gov/mcd/chartno1.htm>

613. NGA World Port Index (Pub. 150)

The *World Port Index* contains a tabular listing of thousands of ports throughout the world, describing their locations, characteristics, facilities, and services available. Information is arranged geographically; the index is arranged alphabetically.

Coded information is presented in columns and rows. This information supplements information in the *Sailing Directions*. The applicable volume of *Sailing Directions* and the number of the harbor chart are given in the *World Port Index*. The *Notice to Mariners* corrects this book.

The *World Port Index* can be found online via the link provided in Figure 613.



Figure 613. Pub. 150 World Port Index.

https://msi.nga.mil/NGAPortal/MSI.portal?_nfpb=true&_st=&_pageLabel=msi_portal_page_62&pubCode=0015

614. NGA Distances Between Ports (Pub. 151)

This publication lists the distances between major ports. Reciprocal distances between two ports may differ due to different routes chosen because of currents and climatic conditions. To reduce the number of listings needed, junction points along major routes are used to consolidate routes converging from different directions.

This book can be most effectively used for voyage planning in conjunction with the proper volume(s) of the *Sailing Directions (Planning Guide)*. It is corrected via the *Notice to Mariners*.

The *Distances Between Ports* can be found online via the link provided in Figure 614.



Figure 614. Pub. 151 Distances Between Ports.

https://msi.nga.mil/NGAPortal/MSI.portal?_nfpb=true&_st=&_pageLabel=msi_portal_page_62&pubCode=0005

615. NGA International Code of Signals (Pub. 102)

This book lists the signals to be employed by vessels at sea to communicate a variety of information relating to safety, distress, medical, and operational information. This publication became effective in 1969.

According to this code, each signal has a unique and complete meaning. The signals can be transmitted via Morse code light and sound, flag, radio telegraph and telephone, and semaphore. Since these methods of signaling are internationally recognized, differences in language between sender and receiver are immaterial; the message will be understood when decoded in the language of the receiver, regardless of the language of the sender. The *Notice to Mariners* corrects *Pub. 102*.

The *International Code of Signals (Pub. 102)* can be found online via the link provided in Figure 615.



Figure 615. Pub. 102 - International Code of Signals.

https://msi.nga.mil/NGAPortal/MSI.portal?_nfpb=true&_st=&_pageLabel=msi_portal_page_62&pubCode=0006

616. Almanacs

For celestial sight reduction, the navigator needs an **almanac** for ephemeris data. The *Nautical Almanac*, produced jointly by the Nautical Almanac Office of the United States Naval Observatory in Washington, and Her Majesty's Nautical Almanac Office of the United Kingdom in Taunton, is the most common almanac used for celestial navigation. It also contains information on sunrise, sunset, moonrise, and moonset, as well as compact sight reduction tables. The *Nautical Almanac* is published annually.

The *Air Almanac* contains slightly less accurate ephemeris data for air navigation, but can be used for marine navigation if slightly reduced accuracy is acceptable.

More detailed information on using the *Nautical Almanac* is located in the Celestial Navigation part of this text. See Chapter 17.

617. *Sight Reduction Tables for Marine Navigation*

Without a calculator or computer programmed for sight reduction, the navigator needs *sight reduction tables* to solve the celestial triangle. Two different sets of tables are commonly used at sea.

NGA *Pub. No. 229, Sight Reduction Tables for Marine Navigation*, consists of six volumes of tables designed for use with the *Nautical Almanac* for solution of the celestial triangle by the **Marcq Saint Hilaire** or **intercept** method. The tabular data are the solutions of the navigational triangle of which two sides and the included angle are known and it is necessary to find the third side and adjacent angle.

Each volume of *Pub. No. 229* includes two 8° degree zones, comprising 15° degree bands from 0° to 90° degrees, with a 1° degree overlap between volumes. *Pub. No. 229* is a joint publication produced by the National Geospatial-Intelligence Agency, the U.S. Naval Observatory, and the Royal Greenwich Observatory.

The complete set of *Pub. No. 229* volumes can be found online via the link in Figure 617.



Figure 617. *Pub. No. 229 - Sight Reduction Tables for Marine Navigation.*

https://msi.nga.mil/NGAPortal/MSI.portal?_nfpb=true&_st=&_pageLabel=msi_portal_page_62&pubCode=0006

618. *Sight Reduction Tables for Air Navigation*

Sight Reduction Tables for Air Navigation, Pub. No. 249, is a joint production effort between the Nautical Almanac Office of the U.S. Naval Observatory and Her Majesty's Nautical Almanac Office. It is issued in three volumes. The title to Volume 1 changed in 2012 to *Rapid Sight Reduction Tables for Navigation*.

Volume 1 contains, for any given position and time, the best selection of seven stars available for observation and, for these seven stars, data for presetting before observation and for accurate reduction of the sights after observation. Volume 1 is updated every five years and may be used without reference to an almanac.

Volumes 2 and 3, primarily used by the air navigator,

cover latitudes 0°-40° and 39°-89° respectively and are permanent tables for integral degrees of declination. They provide sight reduction for bodies with declinations within 30° north or south of the equator, which includes the Sun, the Moon, the navigational planets and many navigational stars.

Pub. No. 249 - Volumes 2 and 3 are available online at the link provided in Figure 618.



Figure 618. *Pub. No. 249 - Sight Reduction Tables for Air Navigation.*

https://msi.nga.mil/NGAPortal/MSI.portal?_nfpb=true&_st=&_pageLabel=msi_portal_page_62&pubCode=0012

619. Catalogs

Military and U.S. Government customers can place orders for NGA products with the Defense Logistics Agency. Ordering information is available on the Defense Supply Center Richmond website.

NGA Hydrographic Products are no longer offered for sale to civilian customers by the National Aeronautical Charting Office (NACO) or the U.S. Government Publishing Office (GPO); however, authorized reproductions of these products can still be purchased from commercial vendors. A list of vendors is available on NGA's Maritime Safety Information website under the Product Catalog tab. See Figure 619a for the link.



Figure 619a. *NGA Products - Vendors List.*

https://msi.nga.mil/NGAPortal/MSI.portal?_nfpb=true&_st=&_pageLabel=msi_portal_page_68

The civilian navigator should also refer to the National Oceanic and Atmospheric Administration (NOAA) Nautical Charts & Publications website for information about purchasing and downloading charts and publications. The site offers other products and services, chart viewers and an interactive Nautical Chart Catalog. See Figure 619b for the link.



Figure 619b. NOAA - Office of Coast Survey Charts & Publications website.

<https://www.nauticalcharts.noaa.gov/staff/chartspubs.html>

MARITIME SAFETY INFORMATION

620. Notice to Mariners

The *Notice to Mariners* is published weekly by the National Geospatial-Intelligence Agency (NGA), prepared jointly with the National Oceanic and Atmospheric Administration (NOAA) and the U.S. Coast Guard. It advises mariners of important matters affecting navigational safety, including dangers to navigation, new hydrographic information, changes in shipping channels and aids to navigation, and other important data. The information in the *Notice to Mariners* is formatted to simplify the correction of paper charts, sailing directions, light lists, and other publications produced by NGA, NOAA, and the U.S. Coast Guard.

It is the responsibility of users to decide which of their charts and publications require correction. Suitable records of *Notice to Mariners* should be maintained to facilitate the updating of charts and publications prior to use.

Information for the *Notice to Mariners* is contributed by: NGA (Department of Defense) for waters outside the territorial limits of the United States; National Ocean Service (National Oceanic and Atmospheric Administration, Department of Commerce), which is charged with surveying and charting the coasts and harbors of the United States and its territories; the U.S. Coast Guard (Department of Homeland Security) which is responsible for, among other things, the safety of life at sea and the establishment and operation of aids to navigation; and the Army Corps of Engineers (Department of Defense), which is charged with the improvement of rivers and harbors of the United States. In addition, important contributions are made by foreign hydrographic offices and cooperating observers of all nationalities.

Of the more than 60 countries that produce nautical charts also produce a notice to mariners. About one third of these are weekly, another third are bi-monthly or monthly, and the rest irregularly issued according to need. Much of the data in the U.S. *Notice to Mariners* is obtained from these foreign notices.

U.S. charts must be corrected only with a U.S. *Notice to Mariners* and U.S. *Local Notice to Mariners*. Similarly,

correct foreign charts using the foreign notice because chart datums often vary according to region and geographic positions are not the same for different datums.

The *Notice to Mariners* consists of a page of **Hydrograms** listing important items in the notice, a chart correction section organized by ascending chart number, a publications correction section, and a summary of broadcast navigation warnings and miscellaneous information.

Mariners are requested to cooperate in the correction of charts and publications by reporting all discrepancies between published information and conditions actually observed and by recommending appropriate improvements. A convenient reporting form is provided in the back of each *Notice to Mariners*.

Notice to Mariners No. 1 of each year contains important information on a variety of subjects which supplements information not usually found on charts and in navigational publications. This information is published as **Special Notice to Mariners Paragraphs**. Additional items considered of interest to the mariner are also included in this *Notice*.

U.S. *Notice to Mariners* can be found via the link provided in Figure 620.



Figure 620. U.S. Notice to Mariners.

https://msi.nga.mil/NGAPortal/MSI.portal?_nfpb=true&st=&pageLabel=msi_portal_page_61

621. Local Notice to Mariners

The *Local Notice to Mariners* is issued by each U.S. Coast Guard District to disseminate important information

affecting navigational safety within that District. This Notice reports changes and deficiencies in aids to navigation maintained by the Coast Guard. Other marine information such as new charts, channel depths, naval operations, and regattas is included. Because these announcements are normally temporary and of short duration they are not included in the NGA *Notice to Mariners*, therefore the *Local Notice to Mariners* may be the only source for that information.

The *Local Notice to Mariners* may be viewed on the Coast Guard Navigation Center website. Mariners can register on the Coast Guard Navigation Center website for a list server subscription where they will be notified when new editions of the *Local Notice to Mariners* are available. Vessels operating in ports and waterways in several districts must separately obtain the *Local Notice to Mariners* from each district. See Figure 621a and Table 621a for a map and complete listing of U.S. Coast Guard Districts.



Figure 621a. U.S. Coast Guard Districts.

COMMANDER, FIRST COAST GUARD DISTRICT
 408 ATLANTIC AVENUE
 BOSTON, MA 02110-3350
 PHONE: DAY 617-223-8356, NIGHT 617-223-8555

COMMANDER, NINTH COAST GUARD DISTRICT
 1240 EAST 9TH STREET
 CLEVELAND, OH 44199-2001
 PHONE: DAY 216-909-6060, NIGHT 216-902-6117

COMMANDER, FIFTH COAST GUARD DISTRICT
 FEDERAL BUILDING
 431 CRAWFORD STREET
 PORTSMOUTH, VA 23704-5004
 PHONE: DAY 757-398-6229, NIGHT 757-398-6390

COMMANDER, ELEVENTH COAST GUARD DISTRICT
 COAST GUARD ISLAND
 BUILDING 52.
 ALAMEDA, CA 94501-5100
 PHONE: DAY 510-437-2980, NIGHT 510-437-3701

Table 621a. U.S. Coast Guard Districts.

COMMANDER, SEVENTH COAST GUARD DISTRICT
BRICKELL PLAZA FEDERAL BUILDING
909 SE 1ST AVENUE
MIAMI, FL 33131-3050
PHONE: DAY/NIGHT 305-415-6800

COMMANDER, SEVENTH COAST GUARD DISTRICT
BRICKELL PLAZA FEDERAL BUILDING
909 SE 1ST AVENUE, RM: 406
MIAMI, FL 33131-3050
PHONE: DAY 305-536-5621, NIGHT 305-536-5611

COMMANDER, EIGHTH COAST GUARD DISTRICT
HALE BOGGS FEDERAL BUILDING
500 POYDRAS STREET
NEW ORLEANS, LA 70130-3330
PHONE: DAY 504-671-2118, NIGHT 504-589-6225

COMMANDER, THIRTEENTH COAST GUARD DISTRICT
FEDERAL BUILDING
915 SECOND AVENUE
SEATTLE, WA 98174-1067
PHONE: DAY 206-220-7280, NIGHT 206-220-7004

COMMANDER, FOURTEENTH COAST GUARD DISTRICT
PRINCE KALANIANAOLE FEDERAL BLDG. 9TH FL 9-204
ALA MOANA BLVD.
HONOLULU, HI 96850-4982
PHONE: DAY 808-535-3409, NIGHT 808-535-3333

COMMANDER, SEVENTEENTH COAST GUARD DISTRICT
P.O. BOX 25517
JUNEAU, AK 99802-5517
PHONE: DAY 907-463-2269, NIGHT 907-463-2000

Table 621a. U.S. Coast Guard Districts.

Local Notice to Mariners can be obtained online via the link provided in Figure 621b.



Figure 621b. Local Notice to Mariners.

<https://www.navcen.uscg.gov/?pageName=lnmMain>

622. Summary of Corrections

A close companion to the *Notice to Mariners* is the *Summary of Corrections*. The *Summary* is published in five volumes. Each volume covers a major portion of the Earth including several chart regions and their subregions. Volume 5 also includes special charts and publications corrected by the *Notice to Mariners*. Since the *Summaries* contain cumulative corrections, any chart, regardless of its print date, can be corrected with the proper volume of the *Summary* and all subsequent *Notice to Mariners*.

The *Summary of Corrections* is available via the link provided in Figure 622.



Figure 622. Summary of Corrections.

<https://msi.nga.mil/MSISiteContent/StaticFiles/SOCDownloadPage.htm>

623. The Maritime Safety Information Website

The NGA Maritime Safety Information website provides worldwide remote query access to extensive menus of maritime safety information 24 hours a day. The Maritime Safety Information website can be accessed via the NGA Homepage under Mission > Products & Services > Maritime Safety Products and Services > <http://msi.nga.mil/NGAPortal/MSI.portal>.

Databases made available for access, query and download include Chart Corrections, Publication Corrections, Chart and Publication Reference Data (current edition number, dates, title, scale), NGA *List of Lights*, U.S. Coast Guard *Light Lists*, World Wide Navigational Warning Service (WWNWS) Broadcast Warnings, Maritime Administration (MARAD) Advisories, Department of State Special Warnings, Mobile Offshore Drilling Units (MODUs), Anti-Shipping Activity Messages (ASAMs), *World Port Index*, and *Radio Navigational Aids*. Publications that are also made available as Portable Document Format (PDF) files include the U.S. *Notice to Mariners*, U.S. *Chart No. 1*, *The American Practical Navigator*, *International Code of Signals*, *Radio Navigational Aids*, *World Port Index*, *Distances Between Ports*, *Sight Reduction Tables for Marine Navigation*, *Sight Reduction Tables for Air Navigation*, and the *Radar Navigation and Maneuvering Board Manual*.

Access to the Maritime Safety Information website is available free to the general public via the internet. Users can provide suggestions, changes, corrections or comments on any of NGA's Maritime Safety Information products and services by submitting the appropriate online reporting form.

Questions concerning the Maritime Safety Information website may be directed to NGA's Maritime Safety Office, MS N64 SFH, National Geospatial-Intelligence Agency, 7500 GEOINT Drive, Springfield, VA, 22150. Email address: Webmaster_NSS@nga.mil.

624. International Convention for the Safety of Life at Sea (SOLAS), 1974

The SOLAS Convention is generally regarded as the most important of all international treaties concerning the

safety of merchant ships. The main objective of the SOLAS Convention is to specify minimum standards for the construction, equipment and operation of ships, compatible with their safety. A general breakdown of convention chapters are provided in Table 624.

Chapter I - General Provisions	Surveying the various types of ships and certifying that they meet the requirements of the convention.
Chapter II-1 - Construction - Subdivision and stability, machinery and electrical installations.	The subdivision of passenger ships into watertight compartments so that after damage to its hull, a vessel will remain afloat and stable.
Chapter II-2 - Fire protection, fire detection and fire extinction	Fire safety provisions for all ships with detailed measures for passenger ships, cargo ships and tankers.
Chapter III - Life-saving appliances and arrangements	Life-saving appliances and arrangements, including requirements for life boats, rescue boats and life jackets according to type of ship.
Chapter IV - Radiocommunications	The Global Maritime Distress Safety System (GMDSS) requires passenger and cargo ships on international voyages to carry radio equipment, including satellite Emergency Position Indicating Radio Beacons (EPIRBs) and Search and Rescue Transponders (SARTs).
Chapter V - Safety of navigation	As it relates to manning, voyage planning, dangers, weather, tides and the obligation to assist those in distress
Chapter VI - Carriage of cargoes	Requirements for the stowage and securing of all types of cargo and cargo containers except liquids and gases in bulk
Chapter VII - Carriage of dangerous goods	Requires the carriage of all kinds of dangerous goods to be in compliance with the International Maritime Dangerous Goods Code (IMDG Code).
Chapter VIII - Nuclear ships	Nuclear powered ships are required, particularly concerning radiation hazards, to conform to the Code of Safety for Nuclear Merchant Ships
Chapter IX - Management for the Safe Operation of Ships	Requires every ship owner and any person or company that has assumed responsibility for a ship to comply with the International Safety Management Code (ISM).
Chapter X - Safety measures for high-speed craft	Makes mandatory the International Code of Safety for High-speed craft (HSC Code).
Chapter XI-1 - Special measures to enhance maritime safety	Requirements relating to organizations responsible for carrying out surveys and inspections, enhanced surveys, the ship identification number scheme, and operational requirements.
Chapter XI-2 - Special measures to enhance maritime security	International Ship and Port Facility Security Code (ISPS Code), the role of the Master in maintaining the security of the ship is not, and cannot be, constrained by the Company, the charterer or any other person; Port facilities security assessments and security plans; Delay, detention, restriction, or expulsion of a ship from a port; and ship security alert system requirements.
Chapter XII - Additional safety measures for bulk carriers	Specific structural requirements for bulk carriers over 150 meters in length.
Chapter XIII - Verification of compliance.	Makes mandatory from 1 January 2016 the IMO Member State Audit Scheme.

Table 624. SOLAS Convention outline.

Chapter XIV - Safety measures for ships operating in polar waters.	Float-free, automatically activated EPIRB. Detectable by Inmarsat geostationary satellite.
--	--

Table 624. SOLAS Convention outline.

The IMO publishes the *SOLAS (Consolidated Edition, 2014)*, which is an easy reference to all SOLAS requirements.

The Centre for International Law website provides an unofficial text of the SOLAS treaty. See Figure 624 for a link to this document.



Figure 624. SOLAS Convention.

<https://cil.nus.edu.sg/rp/il/pdf/1974%20International%20Convention%20for%20the%20Safety%20of%20Life%20at%20Sea-pdf.pdf>

625. Standards of Training, Certification and Watchkeeping (STCW)

The 1978 STCW Convention was the first to establish basic requirements on training, certification and watchkeeping for seafarers on an international level. Previously the standards of training, certification and watchkeeping of officers and ratings were established by individual governments, usually without reference to practices in other countries. As a result standards and procedures varied widely, even though shipping is the most international of all industries.

The convention prescribes minimum standards relating to training, certification and watchkeeping for seafarers which countries are obliged to meet or exceed. The STCW Convention is arranged by the following chapter outline:

1. General Provisions
2. Master and Deck Department
3. Engine Department
4. Radio Communications and Radio Personnel
5. Special Training Requirements for Personnel on Certain Types of Ships
6. Emergency, Occupational Safety, Medical Care and Survival Functions
7. Alternative Certification
8. Watchkeeping

The Federal Register outlines in detail the *Implementa-*

tion of the Amendments to the International Convention on Standards of Training, Certification and Watchkeeping (STCW) for Seafarers, 1978, and Changes to National Endorsements. The document is available via the link provided in Figure 625.



Figure 625. STCW Convention.

<https://www.federalregister.gov/articles/2013/12/24/2013-28032/implementation-of-the-amendments-to-the-international-convention-on-standards-of-training>

626. International Convention for the Prevention of Pollution from Ships (MARPOL)

The International Convention for the Prevention of Pollution from Ships (MARPOL) is the main international convention covering prevention of pollution of the marine environment by ships from operational or accidental causes. The convention includes regulations aimed at preventing and minimizing pollution from ships and currently includes six technical Annexes according to various categories of pollutants, each of which deals with the regulation of a particular group of ship emissions. Special Areas with strict controls on operational discharges are included in most Annexes.

A copy of the MARPOL convention can be found at the Centre for Marine Technology and Ocean Engineering website via the link provided in Figure 626.



Figure 626. MARPOL Convention.

<http://www.mar.ist.utl.pt/mventura/Projecto-Navios-//IMO-Conventions%20%28copies%29/MARPOL.pdf>

CHAPTER 7

SHORT RANGE AIDS TO NAVIGATION

DEFINING SHORT RANGE AIDS TO NAVIGATION

700. Terms and Definitions

A short range/visual Aids to Navigation (ATON) system is a series of interacting external reference devices intended to collectively provide sufficient and timely information with which to safely navigate within and through a waterway when used in conjunction with updated nautical charts. The system includes all navigational devices within visual, audio, or radar range of the mariner. Specifically, these aids to navigation encompass buoys (lighted and unlighted), beacons (lighthouses, lights, ranges, leading lights and daybeacons), sound signals, Radar Beacons (RACON) and Automatic Identification System - Aids to Navigation (AIS-ATON). See Section 2311 (Aids to Radar Navigation) for more information on RACONs. See Section 3020 for more information on AIS-ATON.

This chapter describes the U.S. Aids to Navigation

System (USATONS) as well as the International Association of Marine Aids to Navigation and Lighthouse Authorities (IALA) Maritime Buoyage System (MBS).

Except for minor differences in the U.S. Intracoastal Waterway and Western Rivers (Mississippi River) System, the USATONS is predominately a **lateral** system consistent with Region B requirements of the IALA MBS (Region A for U.S. possessions west of the International Date Line and south of 10 degrees north latitude).

The United States Coast Guard is responsible for establishing, maintaining, and operating marine aids to navigation in the navigable waters of the United States, its territories, and possessions. As such the Coast Guard establishes, maintains and operates lighted and unlighted buoys and beacons (lighthouses, lights, ranges, leading lights and daybeacons), sound signals, AIS-ATON and RACONs. In Addition, the Coast Guard has administrative control over privately owned navigation aids to navigation systems.

BUOYS

701. Definitions and Types

Buoys are floating aids to navigation, anchored at specific locations via chain or synthetic line attached to concrete or cast-steel sinkers. They are used to mark channel limits, indicate isolated dangers, shoals, and obstructions, and to warn the mariner of hazards or dangers. Buoys are typically deployed in locations where beacons would be impractical or cost-prohibited due to waterway geographic configuration and/or environmental conditions, such as water depth, prevailing wind direction and fetch, current, etc. The color, shape, number, topmark, light, and sound characteristics of buoys provide specific marine safety information to mariners.

Buoys are constructed of resilient materials such as non-ferrous steel or plastics such as ionomer polymer plastics (or combination), having structures designed to meet specific environmental factors and purpose. They are classified either lighted or unlighted; either of which can be augmented with sound signals. Unlighted and smaller lighted buoys are shape significant, indicating the type of **mark** the buoy is portraying. There are many different buoy sizes, each designed to meet specific environmental conditions, mariner need, and signal requirements. Larger

buoys are typically used in off-shore and coastal environments, while smaller buoys are deployed in less exposed settings such as inshore and inland waterways.

Lighted buoys are configured with three general components - the buoy hull, which rides above and below the sea surface; the counterweight, which is completely below the water surface and is designed to keep the buoy upright; and the buoy superstructure - also known as the buoy cage (see Figure 701a). Most lighted buoys are referred to as Pillar Buoys, because their superstructure is affixed to a broader circular base, i.e. the buoy hull. Lighted buoy hulls and superstructures can also be constructed with non-ferrous materials, such as ionomer foam, attached to a steel counterweight. Most lighted buoys deployed by the Coast Guard are equipped with Light Emitting Diodes (LED) lanterns, many of which contain the power system and LED within the lantern housing and are referred to as self-contained LED lanterns. Batteries for lighted buoys without self-contained LED lanterns are secured in watertight pockets in the buoy hull or in watertight boxes mounted on the buoy hull. All lighted buoys are equipped with some form of enhanced radar reflector built into or attached to the buoy superstructure. See Figure 701b.

The largest of the U.S. Coast Guard lighted buoys has



Figure 701a. Buoy with counterweight showing.



Figure 701b. Small lighted buoy.

a focal plane of 20+ feet, a radar and nominal visual range of 4 and 3.2 nautical miles respectively in calm seas and clear visibility, and can be moored using conventional buoy chain in depths up to 190 feet of water; greater water depths when moored with synthetic line.

Unlighted buoys are typically classified by their shape (can, nun, or special purpose). The range in size from a 1st class steel buoy weighing 6,000 pounds with a 5-3/4 foot freeboard to small plastic and ionomer foam buoys, weighing 65 pounds with a one foot freeboard. See Figure 701c and Figure 701d.



Figure 701c. Can buoy.



Figure 701d. Nun buoy.

A variety of **special purpose buoys** are owned by other governmental organizations, such as the St. Lawrence

Seaway Development Corporation (SLDC), National Oceanic and Atmospheric Administration (NOAA), and the Department of Defense. These buoys are usually navigational marks or data collection buoys with traditional round, boat-shaped, or discus-shaped hulls.

A special class of buoy, the **Ocean Data Acquisition System (ODAS)** buoy, is moored or floats free in offshore waters. Positions are promulgated through radio warnings. These buoys are generally not large enough to cause damage to a large vessel in an **allision**, but should be given a wide berth regardless, as any loss would almost certainly result in the interruption of valuable scientific experiments. They are generally bright orange or yellow in color, with vertical stripes on moored buoys and horizontal bands on free-floating ones, and have a strobe light for night visibility.

702. Buoy Moorings

Navigation buoys require moorings to hold them in position. Typically the mooring consists of chain and a large concrete or cast steel sinker. Because buoys are subjected to waves, wind and tides, the moorings must be deployed with chain lengths several times greater than the water depth, referred to as the scope of chain, typically about 3 times the water depth. The length of the mooring chain defines a watch circle within which the buoy can be expected to swing around its sinker. This is the reason charted buoy symbols have a “position approximate” circle to indicate its assigned position, whereas a light position is shown by a dot at the exact location. Actual watch circles do not necessarily coincide with the “position approximate” circles which represent them. The below formula is used to calculate the buoy watch circle:

$$\text{Watch Circle Radius} = \sqrt{\text{Water Depth}^2 \times \text{Chain Length}^2}$$

Buoys are assigned to specific geographic positions calculated to within a thousandth of a second, known as the assigned position (AP). The Coast Guard employs the Global Positioning System (GPS) and other methods to place a buoy as close to the AP as reasonably possible and to verify that it is anchored within positioning tolerances. However, placing a buoy at a specific geographic location is secondary to ensuring that the actual location of the buoy best marks the waterway and serves the purpose for which it was intended. Also, a buoy's AP actually indicates the assigned position of the buoy's sinker, which coupled with the buoy's watch circle results in the buoy rarely positioned at its exact assigned position.

703. Lights on Buoys

As mentioned in Section 701, buoy light signals in the USATONS, with rare exception, are exhibited with LEDs. They are powered with secondary lead-acid or similar batteries slow-charged via solar panels. The power config-

uration is designed to accommodate the specific light characteristic and intensity settings for specific geographic locations. For example, a buoy light in Florida, because of greater year-round sunlight, requires a smaller solar power configuration than a buoy light with the same characteristic in Alaska.

704. Audible Signals on Buoys

Sound buoys whether lighted or unlighted are configured much the same as lighted buoys. They can be outfitted with either a bell, gong, whistle, or electronic horn. All but the electronic horn produce sound from the buoy movement as influenced by the restless motion of the sea. Electronic horns, rare on buoys, are powered via electricity produced by batteries. Since bell, gong, and whistle buoys depend on the motion of the sea to produce the sound signal, these types of buoys are deployed in exposed and semi-exposed locations. Horn buoys are deployed in protected and semi-protected locations.

The buoy **bell** is externally mounted on a heavy steel flange, which is permanently affixed to the top center of the buoy hull. The bell produces sound when its struck by one of four (4) tappers that are affixed to the buoy cage and swing freely with the buoy motion. Bells employed by the Coast Guard come in 85 and 225 pound sizes. Gongs are similarly mounted as bells but in sets of three gongs. Each of which gives a distinct tone when struck by the tapper. The three tappers, each of different length to accommodate the gong position, are attached to the buoy cage in the same way as the bell tappers.



Figure 704. Lighted bell buoy.

Whistle buoys make a loud moaning sound as the buoy rises and falls in the sea swells. As the buoy raises air is

drawn into the hollow counterweight tube, which as the buoy falls with the swell is forced through the whistle valve mounted atop the buoy hull emitting the lonely mournful sound of the whistle buoy. Electronic horns are suspended from one of the buoy superstructure cross-members and are powered via a solar panel charged battery power configuration.

Audible signals are intended to provide marine safety information during periods of restricted visibility. Due to the inability of the human ear to accurately judge the direction of a sound source, they are only used to warn mariners of the proximity of a hazard or obstruction. Therefore, although sound signals are valuable, mariners should NOT exclusively rely on them to navigate.

705. Western Rivers Buoys

Buoys used to mark the Mississippi River System are primarily unlighted and are consistent with the following variables:

1. Can buoys are a slightly darker shade of green to improve conspicuity.
2. Unlighted buoys are not numbered.
3. Western River Buoys are not assigned positions.
4. Western River Buoys are not listed in the Light List.

Due to continuously shifting shoals and water levels, unlighted buoys in the Western Rivers are frequently moved to best mark the waterway. The Coast Guard provides buoy positions to the U.S. Army Corps of Engineers periodically, which in turn provides a buoy layer for their Inland Electronic Charts. The few lighted buoys deployed in the Western Rivers are consistent with IALA Region B without revision. See Figure 705 for an image of a Coast Guard River Buoy Tender.

706. Seasonal Buoys

Many lighted buoy are deployed regions that are subject to severe winter icing conditions; namely the U.S East Coast (north of the Chesapeake Bay Entrance), the Great Lakes, and section of Alaska. Ice can cause significant damage to lighted buoys. For example, moving ice can temporarily cause a buoy to heel over, submerge, and/or drag off station, destroying its light signal equipment in the process. Submerged and off-station buoys often pose a hazard to navigation. Figure 706 depicts the USCG recovering an iced damaged buoy.

To mitigate this risk, the Coast Guard replaces many lighted buoys with either unlighted buoys or specially constructed lighted buoys that are better able to survive winter ice conditions. These lighted ice buoys do not meet the same operational characteristics as the “approved lighted buoys they replace, so they’re replaced again in the spring with authorized lighted buoys. The specific seasonal buoy



Figure 705. USCG river buoy tender.



Figure 706. USCG recovering ice damaged buoys.

relief schedules are contained in the applicable Light Lists (column 8).

707. Buoys Marking Wrecks

Buoys used to mark wrecks typically are not placed directly over the wreck it is intended to mark for two primary reasons: First, Coast Guard ATON maintenance

units could be hazarded while approaching to perform maintenance on the buoy, especially when the buoy marks a shallow wreck. Secondly, there is a risk for buoy moorings to foul on the wreck. Therefore, a wreck buoy is usually placed as closely as possible on the seaward or channel ward side of a wreck.

In some situations more than one buoy may be deployed to mark a wreck to avoid possible confusion as to the actual location of the wreck. The *Local Notice to Mariners* should be consulted concerning details regarding the placement of wreck buoys on individual wrecks. The Notice will often define the particulars of the wreck and activities that may be in progress to clear the waterway of the wreck. Sunken wrecks may also move away from the wreck buoy(s) by storms, currents, freshets, or other causes.

Wreck buoys are required to be placed by the owner of the wreck, but they may be placed by the Coast Guard when the owner cannot comply with this requirement. Generally, privately owned aids to navigation are not as reliable as Coast Guard maintained aids to navigation.

Unless a waiver is granted by the responsible Coast Guard District Commander, buoys marking wrecks are required to be lighted and must conform to the U.S. buoyage marking system. They are also required to be marked with the letters "WR" before the buoy lateral number.

The charted depiction of wreck buoys are normally offset from the buoy's actual assigned position so that wreck and buoy symbols do not overlap. Only on the largest scale chart will the assigned position be actually depicted on the chart.

708. Large Navigational Buoys

Large Navigational Buoys (LNB), referred to as Large Automated Navigation Buoys (LANBY) by some international aids to navigation authorities, are major floating aids to navigation sometimes deployed in international waters. They may carry one or more RACON, AIS-ATON, sound, light, and in some cases radio beacon signals. The U. S. Coast Guard no longer deploys these buoys.

709. Buoy Maintenance

With the exception of private aids to navigation and certain U.S. Armed Forces maintained ATON, the Coast Guard is responsible for maintaining the buoys and beacons of the USATONS.

Scheduled unit level or on-scene maintenance of buoys consists of inspecting and replacing if necessary the buoy numbers and reflective tape, light, power, sound, and buoy mooring components. Actions may include cleaning, inspecting, and repairing as necessary the buoy hull, superstructure and counterweight, and verifying that the buoy is within tolerance of its assigned position or that it best marks the waterway and serves the purpose for which



Figure 709. USCG removing marine growth from a buoy.

Periodically, buoys are relieved with a buoy of equivalent type and removed from its AP to undergo depot level maintenance at a Coast Guard or Commercial facility.

Unscheduled maintenance is performed whenever a buoy is discrepant, i.e. not exhibiting the proper characteristics as advertised in the appropriate volume of the Light List.

710. Buoy Limitations

Even though the Coast Guard operates a multi-layered ATON maintenance scheme, buoys cannot be relied on to maintain their precise assigned positions permanently or to display their advertised signal characteristics. Buoys are subjected to a variety of hazards including severe weather, equipment failures, mooring casualties, and allisions. Even in clear weather there is a risk of vessels alliding with a buoy. If struck head-on, a large buoy can inflict severe damage to a vessel, and can sink smaller vessels.

Reduced visibility caused by weather, smoke, or exten-

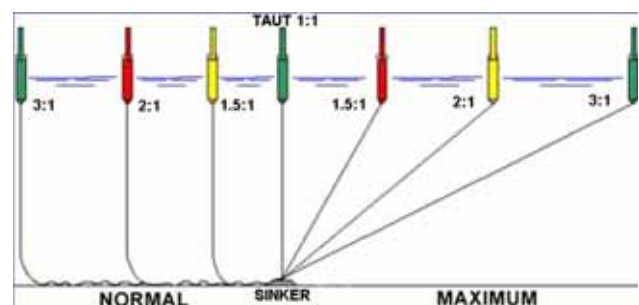

Figure 710. Watch circle radius.

sive background lighting can increase the risks of alliding with a buoy. Many buoys that reported as missing to the Coast Guard were actually run over and sunk. Tugs and towboats towing or pushing barges run a higher risk of al-

liding with buoys, especially in moderate or rough sea conditions. Mariner must report any allision with a buoy to the nearest Coast Guard unit. Failure to do so may cause the next vessel to miss a channel or hit an obstruction marked by a buoy; it can also lead to fines and legal liability.

Buoy symbols depicted on charts indicate the approximate position of the sinker which secures the buoy to the seabed. As mentioned in Section 702, the buoy is always

moving and is rarely directly over its sinker (see Figure 710). Therefore, buoys should never be used for precision navigation. Nor should they be passed close aboard, as doing so risks allision with a yawing buoy or possibly striking the obstruction that the buoy marks.

To ensure the most accurate aids to navigation system, mariners are urged to report discrepancies to the appropriate Coast Guard authority.

BEACONS

711. Definition and Description

A **beacon** is a stationary, short range visual aid to navigation that is fixed to terra firma or the seabed via a foundation, as such they are often referred to as fixed aids to navigation. They are lighted, unlighted, or audible. They range in size, type, and signal capability from large lighthouses to single-pile **daybeacons** to onshore sound signals. Beacon types include: Lighthouses, lights, ranges, leading lights, daybeacons, sound signals, RACONs and AIS-ATON.

712. Major and Minor Lights

Operationally, lighthouses and lights are classified as either **major** or **minor** lights. A **major light** displays a high-intensity light signal with a nominal range of at least 10-nautical miles (statute miles on the Great Lakes). They can have lateral significance but are typically used as primary seacoast, coastal navigation, or harbor entrance lights, and are rarely assigned to a lateral system. **Minor lights** display lower intensity light signals with nominal ranges of less than 10-nautical miles (statute miles on the Great Lakes). They are established in harbors, along channels, waterways, and rivers. They are typically assigned a numbering, coloring, and light scheme consistent with the appropriate lateral buoyage system.

Both major and minor lights display their light signal from a variety of ATON structures, which must have sufficient height to meet its advertised nominal range. As such major lights are necessarily supported by fairly substantial structures.

Most active lighthouses display a light signal consistent with major lights. They operate automatically, i.e. unmanned. Some major light are equipped with backup lights of lower intensity that are automatically energized should there be a causality to the main light. There are many different light optic options for major lights, depending on the operational range requirement of the light signal, atmospheric clarity, background lighting, and other limitations. As LED technology improves, the Coast Guard is converting many of its major lights to LED optics. Few major lights still operate with a classical Fresnel-type lens. Since nearly every lighthouse is unique, the day signal for most major lights is the light structure itself. Offshore major lights



Figure 712. Typical Major Light.

should be given a wide berth, sea room permitting. Figure 712 depicts a typical major light.

Minor light structures are usually not as substantial as major light structures. In fact many minor ATON lights consist of a single wood or steel pile driven into the seabed, with a self-contained LED, and the appropriate day signal.

713. Range Lights

A range consists of two or more beacons so positioned with respect to each other that when seen aligned they mark a line of definite bearing, the **range line** commonly delineating the centerline of a navigation channel. These aids to navigation are typically affixed with dual-colored vertically striped **dayboards** for alignment during daylight hours and if lighted, exhibit lighted signals during periods of darkness. Some ranges

exhibit a light signal 24-hours a day, which may or may not be equipped with dayboards. The rear range is designed and constructed so that it is higher than the front range to enable mariners to align the ranges; the rear range light will always be above the front light for the height of eye of the vessels transiting the range line. The International Association of Marine Aids to Navigation and Lighthouse Authorities (IALA) refers to ranges as Leading Lines. Figure 713 illustrates the mariner's observation of range markers from three separate aspects when transiting the Range Line: 1. Left of Range Line; 2. On the Range Line; and 3. Right of Range Line.

Range lights provide horizontal vessel positioning insight to mariners transiting the Range Line by vertically displaying white, red, green or yellow lights (rear light above and behind the forward light). The color is selected that presents the most conspicuous and least confusing signal to the mariner. Most range lights display a very narrow light beam of high intensity focused down the range line, hence the brilliance of the light signal decreases significant-

ly when observed just a few degrees either side of the range line. The specific arc of high intensity for range lights can be found in Column 8 of the applicable Light List.

While range lights are conspicuous to mariners traversing the channel for which they mark, Range structures located in adjacent navigable waters can pose a hazard to navigation. Therefore, marine range structures are typically augmented with additional or passing lights to alert mariners as to the location of the range structure.

Additional lights are not readily recognizable to the mariner. They mark range structures whose light have a focal plane of 40 feet or lower. Additional lights are typically mounted above the range light optic and have the same color and light characteristic as the front range light. **Passing Lights** mark ranges whose focal plane is taller than 40 feet. They are mounted closer to the water surface, typically exhibit a white light and display light characteristics different from the rear range light. Passing lights are listed separately in the Light List and as such have a separate Light List number.

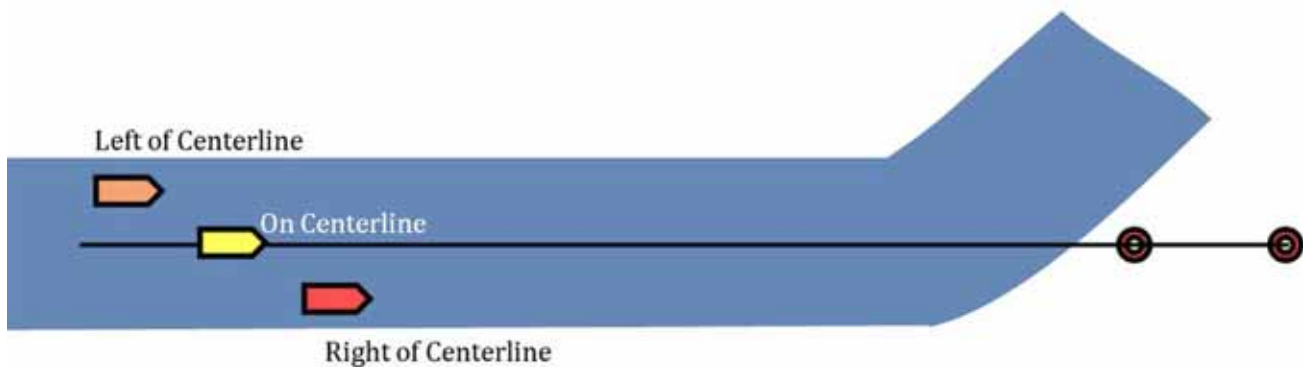
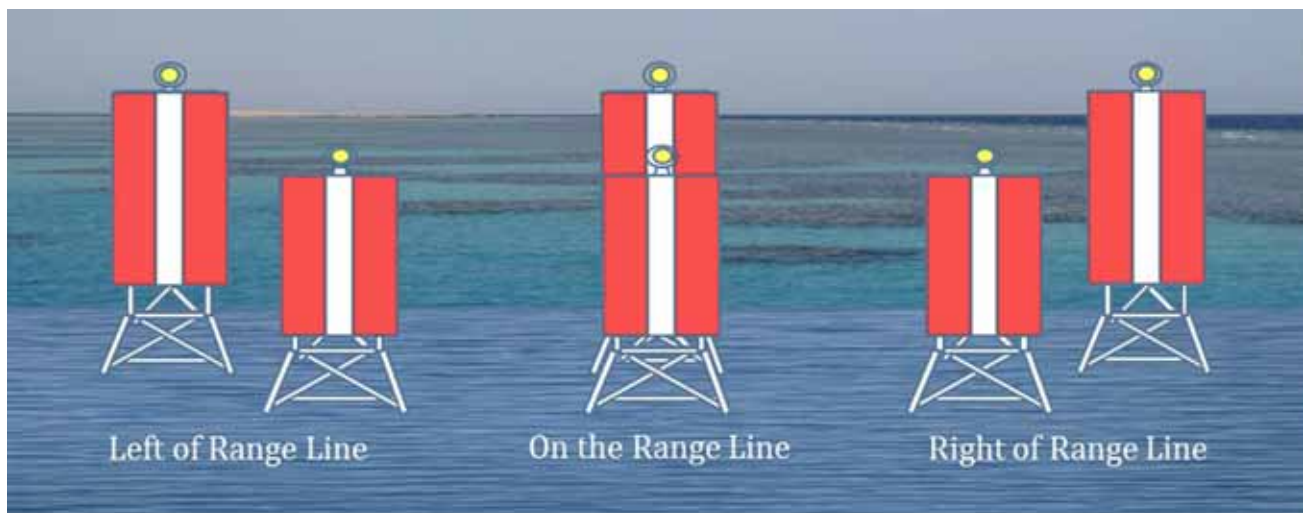

Figure 713. Example of Range Light aspects.

714. Directional Lights - Port Entry Lights

Directional Lights are also known as Port Entry Lights (PEL). IALA refers to these types of lights as **Sector**

Lights. However, the term *Sector Lights* in the *USATONS* has a distinctively different meaning - see Section 719. They are comprised of a single light source fitted with a very sophisticated lens that projects three or more narrow high intensity light arcs of different colors, relative to a predetermined bearing line, typically a channel centerline. Newer directional lights also include distinct light characteristics, such as flashing sectors that are readily recognizable to the observer as they move to either side away from the bearing line.

Directional lights, although usually not as sensitive as a two station range, are invaluable aids to navigation employed in those locations where establishing a two station range is impractical. They are most effective for short channel segments. Figure 714 presents an example of a three color directional light.

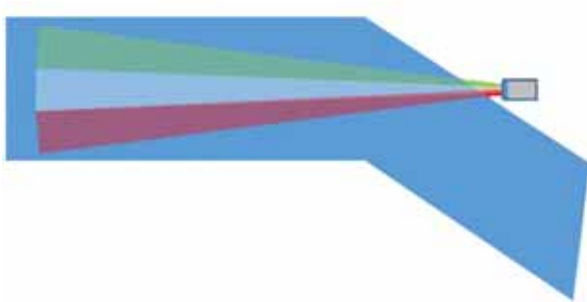

Figure 714. Example of a three color directional light.

715. Unlighted Beacons - Daybeacons

A daybeacon is identified by the color, shape, and lateral number. The simplest form of daybeacon consists of a single pile with a dayboard affixed at or near its top (see Figure 715). Daybeacons may be used to form an unlighted range.

Dayboards are affixed to all daybeacons and to most minor lights. They are shape-significant and usually have numbers and/or letters affixed to identify the specific aid to navigation. Retro-reflective background, edges, and numbers assist their identification at night when illuminated by an external light source, such as a vessel search light. Dayboard size, along with atmospheric visibility, will determine the range at which a dayboard can be detected and properly identified.

716. Aeronautical Lights

Aeronautical lights (also referred to as Aero beacons) may be the first lights observed at night when approaching the coast, they are intended primarily for aircraft navigation.

Those situated near the coast and visible from sea are listed in the *List of Lights* but are not listed in the Coast Guard Light Lists. They usually flash alternating white and



Figure 715. Unlighted beacon.

green. Aeronautical lights are sequenced geographically in the *List of Lights*. However, since they are not maintained for marine navigation, they are subject to changes, as such the Coast Guard may not be informed of the changes. However, they will be published in *Notice to Airmen*.

717. Bridge Lights

Navigational lights on bridges in the U.S. are prescribed by the Coast Guard consistent with the U.S. Code and the U.S. Code of Federal Regulations (CFR). Lighting requirements vary depending on the type of bridge structure.

Fixed Bridges - Each span over a navigable waterway is required to have two green range lights with a fixed characteristic that mark the center of the navigable waterway or channel. The bridge piers are required to be lighted with fixed red lights. Per 33 CFR 118.100, some lighting schemes on fixed bridges may be consistent with the waterway's lateral ATON system.

Swing bridges when closed are required to display three fixed red lights, one at the center of the span and one on each end of the span. When the span is open, the lights are to show fixed green in line with the horizontal axis of the bridge, so as two green lights can be seen from either direction. Bridge piers display lights similar to those for fixed bridges. **Bascule bridges**, single or double span, are required to display fixed red lights at the end of the span(s) when lifted. Once the span is completely open - fixed green lights are displayed. Bridge piers display lights similar to those for fixed bridges. The lighting requirements for **lift bridges** are similar to bascule bridges. A fixed red light is

displayed at the center of the span when it is down and a fixed green light is displayed when the span is completely open.

Refer to the U.S. Coast Guard Office of Bridge Administration pamphlet *Bridge Lighting and Other Signals* for graphic depictions of bridge lighting regulations.

Bridges may also be augmented with reflective material, radar reflectors, RACON signals - typically marking the center span of the navigable waterway - or AIS-ATON signals - typically marking the bridge piers and other obstructions.

AIDS TO NAVIGATION LIGHT CHARACTERISTICS

718. Characteristics

An aid to navigation light has a distinctive rhythm or characteristic, which is the sequence of light and dark periods within a specified time period; or when the light is on or off. The period of darkness within the sequence is referred to as the **eclipse**. The sequence includes the number of light and eclipse periods within a specified time duration. For example, the sequence of an aid to navigation displaying a standard Flashing 4 second light signal would be observed as 0.4 second period of light followed by a 3.6 second eclipse per each 4 second sequence.

The light signal color does not impact the light characteristic but adds to the distinguishing features of the ATON light signal. If, in the previous example, the light signal color was green, then the light's characteristic would be further refined as Flashing Green every 4 seconds.

Generally, **Flashing** light signals display light for a much shorter period than the accompanying eclipse. The period of light is greater than the eclipse with an **Occulting**

light signal. **Isophase** light signals display equal periods of light and eclipse. **Group Flashing** signals display a specified number of flashes followed by a longer eclipse period. An **Alternating** light characteristic will display more than one light within the specified sequence.

The light characteristic of an aid to navigation is one of the methods for distinguishing one light signal from another and for conveying specific marine safety information. For example, a quick flashing light in a lateral system typically indicates that the axis of the waterway or channel changes direction at or near that location.

Most lighted aids to navigation are equipped with light sensors, daylight controls, that turn the light signal off during daylight. Due to a variety of factors, not all ATON lights in an area turn off or on at the same time. It is not uncommon to observe some ATON lights on while others are off, especially during twilight or during heavy overcast conditions.

The following table lists some of the more common ATON light signal rhythms/characteristics (see Table 718).





TYPE	ABBREVIATION	GENERAL DESCRIPTION	ILLUSTRATION*
Fixed	F.	A continuous and steady light.	
Occulting	Oc.	The total duration of light in a period is longer than the total duration of darkness and the intervals of darkness (eclipses) are usually of equal duration. Eclipse regularly repeated.	
Group occulting	Oc.(2)	An occulting light for which a group of eclipses, specified in number, is regularly repeated.	
Composite group occulting	Oc.(2+1)	A light similar to a group occulting light except that successive groups in a period have different numbers of eclipses.	

Table 718. Light rhythm characteristics.







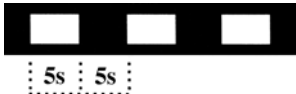

TYPE	ABBREVIATION	GENERAL DESCRIPTION	ILLUSTRATION*
Isophase	Iso	A light for which all durations of light and darkness are clearly equal.	
Flashing	Fl.	A light for which the total duration of light in a period is shorter than the total duration of darkness and the appearances of light (flashes) are usually of equal duration (at a rate of less than 50 flashes per minute).	
Long flashing	L.Fl.	A single flashing light for which an appearance of light of not less than 2 sec. duration (long flash) is regularly repeated.	
Group flashing	Fl.(3)	A flashing light for which a group of flashes, specified in number, is regularly repeated.	
Composite group flashing	Fl.(2+1)	A light similar to a group flashing light except that successive groups in a period have different numbers of flashes.	
Quick flashing	Q.	A light for which a flash is regularly repeated at a rate of not less than 50 flashes per minute but less than 80 flashes per minute.	
Group quick flashing	Q.(3)	A light for which a specified group of flashes is regularly repeated; flashes are repeated at a rate of not less than 50 flashes per minute but less than 80 flashes per minute.	
	Q.(9)		
	Q.(6)+L.Fl.		
Interrupted quick flashing	I.Q.	A light for which the sequence of quick flashes is interrupted by regularly repeated eclipses of constant and long duration.	

Table 718. Light rhythm characteristics.

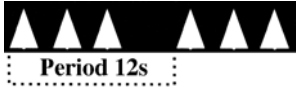

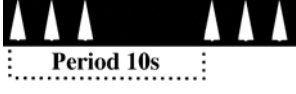







TYPE	ABBREVIATION	GENERAL DESCRIPTION	ILLUSTRATION*
Very quick flashing	V.Q.	A light for which a flash is regularly repeated at a rate of not less than 80 flashes per minute but less than 160 flashes per minute.	
Group very quick flashing	V.Q.(3)	A light for which a specified group of very quick flashes is regularly repeated.	
	V.Q.(9)		
	V.Q.(6)+L.Fl.		
Interrupted very quick flashing	I.V.Q.	A light for which the sequence of very quick flashes is interrupted by regularly repeated eclipses of constant and long duration.	
Ultra quick flashing	U.Q.	A light for which a flash is regularly repeated at a rate of not less than 160 flashes per minute.	
Interrupted ultra quick flashing	I.U.Q.	A light for which the sequence of ultra quick flashes is interrupted by regularly repeated eclipses of constant and long duration.	
Composite group flashing	Fl.(2+1)	A light similar to a group flashing light except that successive groups in a period have different numbers of flashes.	
Morse code	Mo.(U)	A light for which appearances of light of two clearly different durations are grouped to represent a character or characters in Morse Code.	
Fixed and flashing	F.Fl.	A light for which a fixed light is combined with a flashing light of greater luminous intensity.	
Alternate light	Al.	A light showing different colors alternately	<p>* Periods shown are examples only.</p>

Table 718. Light rhythm characteristics.

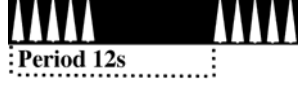
TYPE	ABBREVIATION	GENERAL DESCRIPTION	ILLUSTRATION*
NOTE: Alternating lights may be used in combined form with most of the previous types of lights			

Table 718. Light rhythm characteristics.

719. Light Sectors

A light sector is the arc over which a light is visible, described in degrees true, as observed from seaward

towards the light. Sectors may be used to define the distinctive color difference of two adjoining sectors, or an obscured sector.

When different color sectors are displayed from a sin-

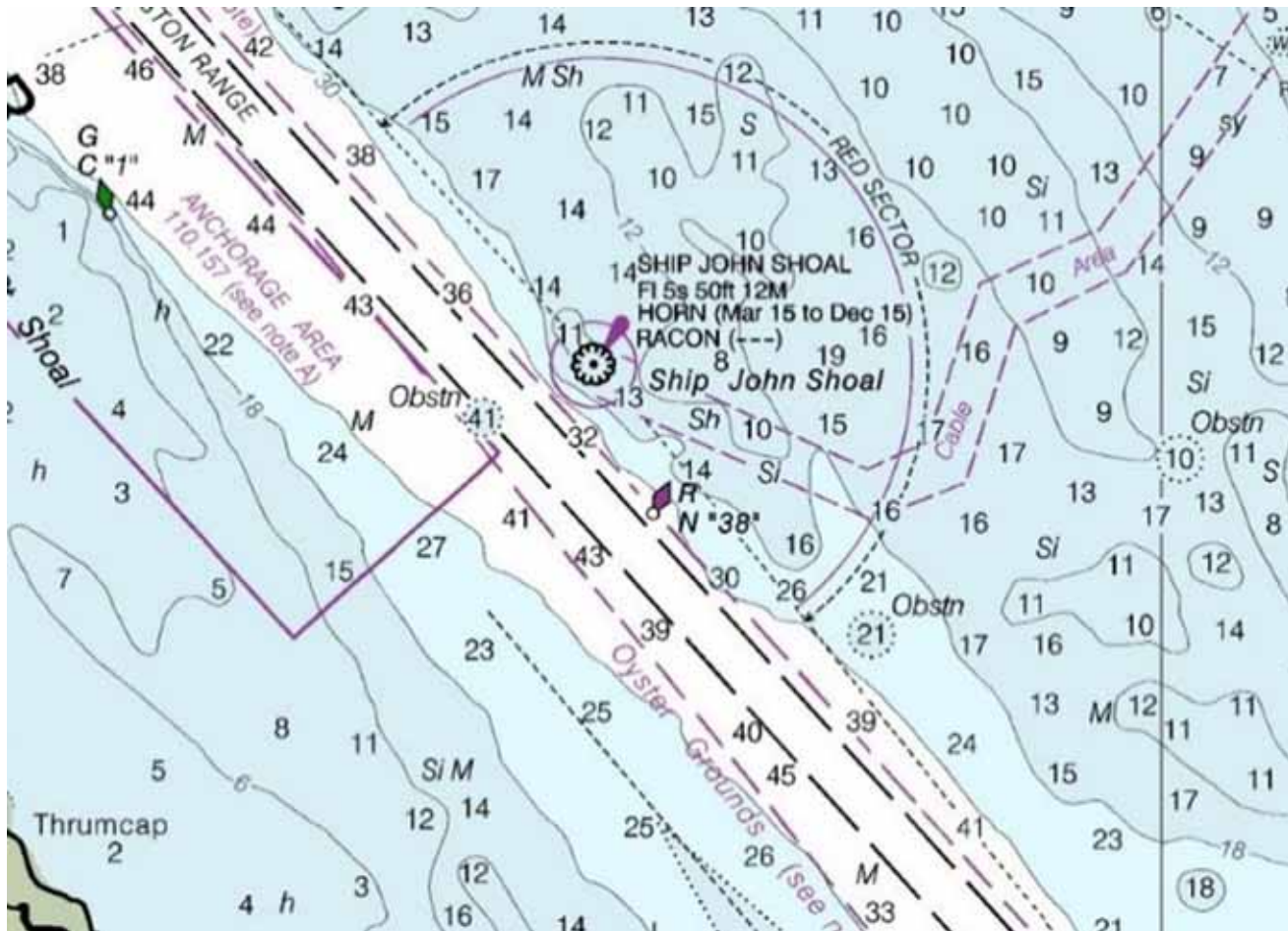

Figure 719. Portion of a chart depicting a light sector.

gle light (not to be confused with Directional or Port Entry Lights) one or more of the sectors are typically red indicating danger areas that mariners should avoid. Usually the color of the light is white with the red sector(s) annotated on the chart and column 4 of the Light List entry for the light. For example, the characteristic for a typical shoal light is entered in the Light List as “FL W 5s (R Sector).”

The transition from one color to another is not abrupt. The colors change through an arc of uncertainty of 2° or greater, depending on the optical design of the light. Therefore determining bearings by observing the color change is

less accurate than obtaining a bearing with an azimuth circle. Figure 719 depicts a light sector example as found on a nautical chart.

720. Factors Affecting Range and Characteristics

Atmospheric conditions have a considerable impact on the distance at which an ATON light can be detected and recognized. Fog, smoke, haze, dust, and various forms of precipitation usually reduce detection and recognition distance. On the other hand, the atmospheric refraction of light

may actually cause a navigation aid to be detected at a greater distance than ordinary circumstances would dictate. Some atmospheric conditions coupled with the geographic distance from a light may reduce the apparent duration of a light's flash, or give white lights a reddish hue. At times in clear weather green lights may appear to have a more whitish hue. Aid to navigation light signals placed at higher elevations are more frequently obscured by clouds, mist, and fog than those near sea level. In regions where ice conditions prevail, ice and snow may cover the optic of the light signal reducing its luminous range and/or altering the apparent signal color seen by the observer.

The distance from a light cannot be estimated by its apparent brightness. There are too many factors that can affect a light signal's perceived intensity. Also, a powerful, distant light may sometimes be confused with a smaller closer light with similar characteristics. Every light signal observed should be carefully evaluated to ensure that the light signal is properly identified with its proper aid to navigation.

The presence, location, and number of shore lights and background lighting may make it difficult to distinguish aid to navigation light signals from the background lighting. Aid to navigation lights may be obscured by various shore obstructions, be they natural or man-made. Mariners should report any such obstruction to the nearest Coast Guard unit.

A light signal's **loom** is sometimes seen through haze or the reflection from low-lying clouds when the light is beyond its geographic range. Only the most powerful lights can generate a loom. The loom may be sufficiently defined to obtain a bearing.

At short distances, some light signals inside a lighthouse copula emitted via rotating lanterns may show a faint continuous light, or faint flashes, between regular flashes. This is likely due to reflections of a rotating lens on panes of glass in the lighthouse copula.

If a light is not observed within a reasonable time after prediction the prudent mariner will, without delay, ascertain the vessel's position via other position fixing methods to determine the possibility of standing into danger. The inability to observe a light signal may be caused by the light being obscured or extinguished.

The apparent characteristic of a complex light may change with the distance of the observer. For example, a light with a characteristic of fixed white and alternating flashing white and red may initially show as a simple flashing white light. As the vessel draws nearer, the red flash will become visible and the characteristic will apparently be alternating flashing white and red. Later, the fainter fixed white light will be seen between the flashes and the true characteristic of the light finally recognized as fixed white, alternating flashing white and red (F W A I W R). This phenomenon results from the greater luminous intensity generated by the white light signal. White lights can produce the greatest luminous intensity, green lights less so, and red lights are the least of the three. This fact also accounts for the different ranges given in the Light Lists for some multi-color sector lights. A light signal with the same light source has different luminous and nominal ranges according to the color of the lens or glass.

All observed aid to navigation discrepancies should be reported immediately to the nearest Coast Guard unit.

SOUND SIGNALS

721. Types of Sound Signals

Most lighthouses and offshore light platforms, as well as some minor light structures and buoys, are equipped with sound-producing devices to help the mariner in periods of low visibility. Charts and *Light Lists* contain the information required for positive identification. Buoys fitted with bells, gongs, or whistles actuated by wave motion may produce no sound when the sea is calm. Sound signals are not designed to identify the buoy or beacon for navigation purposes. Rather, they allow the mariner to pass clear of the buoy or beacon during low visibility.

Sound signals vary. The navigator must use the *Light List* to determine the exact length of each blast and silent interval. The various types of sound signals also differ in tone, facilitating recognition of the respective stations.

Diaphones produce sound with a slotted piston moved back and forth by compressed air. Blasts may consist of a high and low tone. These alternate-pitch signals are called "two-tone." Diaphones are not used by the Coast Guard, but the mariner may find them on some private navigation aids.

Horns produce sound by means of a disc diaphragm operated pneumatically or electrically. Duplex or triplex horn units of differing pitch produce a chime signal.

Sirens produce sound with either a disc or a cup-shaped rotor actuated electrically or pneumatically. Sirens are not used on U.S. navigation aids.

Whistles use compressed air emitted through a circumferential slot into a cylindrical bell chamber.

Bells and gongs are sounded with a mechanically operated hammer.

722. Limitations of Sound Signals

As aids to navigation, sound signals have serious limitations because sound travels through the air in an unpredictable manner.

It has been clearly established that:

1. Sound signals are heard at greatly varying distances and that the distance at which a sound signal can be heard may vary with the bearing and timing of the signal.

2. Under certain atmospheric conditions, when a sound signal has a combination high and low tone, it is not unusual for one of the tones to be inaudible. In the case of sirens, which produce a varying tone, portions of the signal may not be heard.
3. When the sound is screened by an obstruction, there are areas where it is inaudible.
4. Operators may not activate a remotely controlled sound aid for a condition unobserved from the controlling station.
5. Some sound signals cannot be immediately started.
6. The status of the vessel's engines and the location of the observer both affect the effective range of the aid.

These considerations justify the utmost caution when navigating near land in a fog. Navigator can never rely on sound signals alone; they should continuously monitor both the radar and fathometer when in low visibility. They should place lookouts in positions where the noises in the ship are least likely to interfere with hearing a sound signal. The aid upon which a sound signal rests is usually a good radar target, but collision with the aid or the danger

it marks is always a possibility.

Emergency signals are sounded at some of the light and fog signal stations when the main and stand-by sound signals are inoperative. Some of these emergency sound signals are of a different type and characteristic than the main sound signal. The characteristics of the emergency sound signals are listed in the *Light List*.

Mariners should never assume:

1. That they are out of ordinary hearing distance because s/he fails to hear the sound signal.
2. That because they hear a sound signal faintly, they are far from it.
3. That because they hear it clearly, they are near it.
4. That the distance from and the intensity of a sound on any one occasion is a guide for any future occasion.
5. That the sound signal is not sounding because they do not hear it, even when in close proximity.
6. That the sound signal is emanating from the apparent direction the sound heard.

MARITIME BUOYAGE SYSTEMS

723. Buoyage System Types

There are two major types of buoyage systems in the maritime world today, the **lateral system** and the **cardinal system**.

The lateral system is best suited for well-defined channels. The description of each buoy indicates the direction of danger relative to the course which is normally followed. In principle, the positions of marks in the lateral system are determined by the **general direction** taken by the mariner when approaching port from seaward. These positions may also be determined with reference to the main stream of flood current. The United States Aids to Navigation System is a lateral system.

The cardinal system is best suited for coasts with numerous isolated rocks, shoals, and islands, and for dangers in the open sea. The characteristic of each buoy indicates the approximate true bearing of the danger it marks. Thus, an eastern quadrant buoy marks a danger which lies to the west of the buoy. The following pages diagram the cardinal and lateral buoyage systems as found outside the United States.

724. The IALA Maritime Buoyage System

There has long been disagreement over the way in which buoy lights should be used since they first appeared towards the end of the 19th century. In particular, some countries favored using red lights to mark the port side of channels when entering from sea while others favored them

for marking the starboard side. Another major difference of opinion revolved around the principles to be applied when designing buoy systems. Most countries adopted the principle of the **Lateral** system while several other countries also favored using the principle of the **Cardinal system**.

In 1957 the, **International Association of Lighthouse Authorities (IALA)** was formed in order to support the goals of the technical lighthouse conferences which had been convening since 1929. Attempts to bring complete unity had little success. Fresh impetus was given to the task of the IALA Committee, by a series of disastrous wrecks in the Dover Strait area in 1971. These wrecks, situated in one lane of a traffic separation scheme, defied all attempts to mark them in a way that could be readily understood by mariners.

To meet the conflicting requirements, it was deemed necessary to formulate two Lateral systems, one using the color red to mark the port side of the channels entering from sea and the other using the color red to mark the starboard side of channels. These were called System A and System B respectively. The rules for System A, which included both cardinal and lateral marks, were completed in 1976 and agreed by the International Maritime Organization (IMO). The System was introduced in 1977 and its use has gradually spread throughout Europe, Australia, New Zealand, Africa, the Gulf and some Asian Countries.

The rules for System B were completed in early 1980. These were considered suitable for application in North, Central and South America. Japan, Republic of Korea and

Philippines.

The rules for the two Systems were so similar that the IALA Executive Committee was able to combine the two sets of rules into one, known as “The **IALA Maritime Buoyage System**”. This single set of rules allows Aids to Navigation Authorities the choice of using red to port or red to starboard, on a regional basis; the two regions being known as **Region A** and **Region B**.

At a Conference convened by IALA in November 1980 with the assistance of IMO and the International Hydrographic Organization (IHO) Aid to Navigation Authorities from 50 countries and the representatives of nine International Organizations concerned with aids to navigation met and agreed to adopt the rules of the new combined system. The boundaries of the buoyage regions were also decided and illustrated on a map annexed to the rules.

Today IALA operates as a non-governmental non-profit international organization, devoted to the harmonization of marine aids to navigation. It promotes information exchange and recommends improvements based on new technologies

725. Types of Marks

The **IALA Maritime Buoyage System** applies to all fixed and floating marks, other than lighthouses, sector lights, range lights, daymarks, lightships and large navigational buoys, which indicate:

1. The side and center-lines of navigable channels
2. Natural dangers, wrecks, and other obstructions
3. Regulated navigation areas
4. Other important features

Most lighted and unlighted beacons other than range marks are included in the system. In general, beacon topmarks will have the same shape and colors as those used on buoys. The system provides five types of marks which may be used in any combination:

1. Lateral marks indicate port and starboard sides of channels.
2. Cardinal marks, named according to the four points of the compass, indicate that the navigable water lies to the named side of the mark.
3. Isolated danger marks erected on, or moored directly on or over, dangers of limited extent.
4. Safe water marks, such as midchannel buoys.
5. Special marks, the purpose of which is apparent from reference to the chart or other nautical documents.

Characteristics of Marks

The significance of a mark depends on one or more features:

1. By day—color, shape, and topmark

2. By night—light color and phase characteristics

Colors of Marks

The colors red and green are reserved for lateral marks, and yellow for special marks. The other types of marks have black and yellow or black and red horizontal bands, or red and white vertical stripes.

Shapes of Marks

There are five basic buoy shapes:

1. Can
2. Cone
3. Sphere
4. Pillar
5. Spar

In the case of can, conical, and spherical, the shapes have lateral significance because the shape indicates the correct side to pass. With pillar and spar buoys, the shape has no special significance.

The term “pillar” is used to describe any buoy which is smaller than a large navigation buoy (LNB) and which has a tall, central structure on a broad base; it includes beacon buoys, high focal plane buoys, and others (except spar buoys) whose body shape does not indicate the correct side to pass.

Topmarks

The IALA System makes use of **can, conical, spherical, and X-shaped** topmarks only. Topmarks on pillar and spar buoys are particularly important and will be used wherever practicable, but ice or other severe conditions may occasionally prevent their use.

Colors of Lights

Where marks are lighted, red and green lights are reserved for lateral marks, and yellow for special marks. The other types of marks have a white light, distinguished one from another by phase characteristic.

Phase Characteristics of Lights

Red and green lights may have any phase characteristic, as the color alone is sufficient to show on which side they should be passed. Special marks, when lighted, have a yellow light with any phase characteristic not reserved for white lights of the system. The other types of marks have clearly specified phase characteristics of white light: various quick-flashing phase characteristics for cardinal marks, group flashing (2) for isolated danger marks, and relatively long periods of light for safe water marks.

Some shore lights specifically excluded from the IALA System may coincidentally have characteristics corresponding to those approved for use with the new marks. Care is needed to ensure that such lights are not misinterpreted.

726. IALA Lateral Marks

Lateral marks are generally used for well-defined channels; they indicate the port and starboard hand sides of the route to be followed, and are used in conjunction with a **conventional direction of buoyage**.

This direction is defined in one of two ways:

1. **Local direction of buoyage** is the direction taken by the mariner when approaching a harbor, river estuary, or other waterway from seaward.
2. **General direction of buoyage** is determined by the buoyage authorities, following a clockwise direction around continental land-masses, given in sailing directions, and, if necessary, indicated on charts by a large open arrow symbol.

In some places, particularly straits open at both ends, the local direction of buoyage may be overridden by the general direction.

Along the coasts of the United States, the characteristics assume that proceeding “from seaward” constitutes a clockwise direction: a southerly direction along the Atlantic coast, a westerly direction along the Gulf of Mexico coast, and a northerly direction along the Pacific coast. On the Great Lakes, a westerly and northerly direction is taken as being “from seaward” (except on Lake Michigan, where a southerly direction is used). On the Mississippi and Ohio Rivers and their tributaries, the characteristics of aids to navigation are determined as proceeding from sea toward the head of navigation. On the Intracoastal Waterway, proceeding in a generally southerly direction along the Atlantic coast, and in a generally westerly direction along the gulf coast, is considered as proceeding “from seaward.”

727. IALA Cardinal Marks

A **cardinal mark** is used in conjunction with the compass to indicate where the mariner may find the best navigable water. It is placed in one of the four quadrants (north, east, south, and west), bounded by the true bearings NW-NE, NE-SE, SE-SW, and SW-NW, taken from the point of interest. A cardinal mark takes its name from the quadrant *in which it is placed*.

The mariner is safe if they pass north of a north mark, east of an east mark, south of a south mark, and west of a west mark.

A cardinal mark may be used to:

1. Indicate that the deepest water in an area is on the named side of the mark.
2. Indicate the safe side on which to pass a danger.
3. Emphasize a feature in a channel, such as a bend, junction, bifurcation, or end of a shoal.

Cardinal System Topmarks

Black double-cone topmarks are the most important feature, by day, of cardinal marks. The cones are vertically placed, one over the other. The arrangement of the cones is very logical: North is two cones with their points up (as in “north-up”). South is two cones, points down. East is two cones with bases together, and west is two cones with points together, which gives a wineglass shape. “West is a Wineglass” is a memory aid.

Cardinal marks displays topmarks whenever practicable, with the cones as large as possible and clearly separated.

Colors

Black and yellow horizontal bands are used to color a cardinal mark. The position of the black band, or bands, is related to the points of the black topmarks.

N	Points up	Black above yellow
S	Points down	Black below yellow
W	Points together	Black, yellow above and below
E	Points apart	Yellow, black above and below

Shape

The shape of a cardinal mark is not significant, but buoys must be pillars or spars.

Lights

When lighted, a cardinal mark exhibits a white light; its characteristics are based on a group of quick or very quick flashes which distinguish it as a cardinal mark and indicate its quadrant. The distinguishing quick or very quick flashes are:

North—Uninterrupted
East—three flashes in a group
South—six flashes in a group followed by a long flash
West—nine flashes in a group

As a memory aid, the number of flashes in each group can be associated with a clock face: 3 o'clock—E, 6 o'clock—S, and 9 o'clock—W.

The long flash (of not less than 2 seconds duration), immediately following the group of flashes of a south cardinal mark, is to ensure that its six flashes cannot be mistaken for three or nine.

The periods of the east, south, and west lights are, respectively, 10, 15, and 15 seconds if quick flashing; and 5, 10, and 10 seconds if very quick flashing.

Quick flashing lights flash at a rate between 50 and 79 flashes per minute, usually either 50 or 60. Very quick flashing lights flash at a rate between 80 and 159 flashes per minute, usually either 100 or 120.

It is necessary to have a choice of quick flashing or very quick flashing lights in order to avoid confusion if, for example, two north buoys are placed near enough to each other for one to be mistaken for the other.

728. IALA Isolated Danger Marks

An **isolated danger mark** is erected on, or moored on or above, an isolated danger of limited extent which has navigable water all around it. The extent of the surrounding navigable water is immaterial; such a mark can, for example, indicate either a shoal which is well offshore or an islet separated by a narrow channel from the coast.

Position

On a chart, the position of a danger is the center of the symbol or sounding indicating that danger; an isolated danger buoy may therefore be slightly displaced from its geographic position to avoid overprinting the two symbols. The smaller the scale, the greater this offset will be. At very large scales the symbol may be correctly charted.

Topmark

A black double-sphere topmark is, by day, the most important feature of an isolated danger mark. Whenever practicable, this topmark will be carried with the spheres as large as possible, positioned vertically, and clearly separated.

Color

Black with one or more red horizontal bands are the colors used for isolated danger marks.

Shape

The shape of an isolated danger mark is not significant, but a buoy will be a pillar or a spar.

Light

When lighted, a white flashing light showing a group of two flashes is used to denote an isolated danger mark. As a memory aid, associate two flashes with two balls in the topmark.

729. IALA Safe Water Marks

A **safe water mark** is used to indicate that there is navigable water all around the mark. Such a mark may be used as a center line, mid-channel, or landfall buoy.

Color

Red and white vertical stripes are used for safe water marks, and distinguish them from the black-banded, danger-marking marks.

Shape

Spherical, pillar, or spar buoys may be used as safe water marks.

Topmark

A single red spherical topmark will be carried, whenever practicable, by a pillar or spar buoy used as a safe water mark.

Lights

When lighted, safe water marks exhibit a white light. This light can be occulting, isophase, a single long flash, or Morse "A." If a long flash (i.e. a flash of not less than 2 seconds) is used, the period of the light will be 10 seconds. As a memory aid, remember a single flash and a single sphere topmark.

730. IALA Special Marks

A **special mark** may be used to indicate a special area or feature which is apparent by referring to a chart, sailing directions, or notices to mariners. Uses include:

1. Ocean Data Acquisition System (ODAS) buoys
2. Traffic separation marks
3. Spoil ground marks
4. Military exercise zone marks
5. Cable or pipeline marks, including outfall pipes
6. Recreation zone marks

Another function of a special mark is to define a channel within a channel. For example, a channel for deep draft vessels in a wide estuary, where the limits of the channel for normal navigation are marked by red and green lateral buoys, may have its boundaries or centerline marked by yellow buoys of the appropriate lateral shapes.

Color

Yellow is the color used for special marks.

Shape

The shape of a special mark is optional, but must not conflict with that used for a lateral or a safe water mark. For example, an outfall buoy on the port hand side of a channel could be can-shaped but not conical.

Topmark

When a topmark is carried it takes the form of a single yellow X.

Lights

When a light is exhibited it is yellow. It may show any phase characteristic except those used for the white lights of cardinal, isolated danger, and safe water marks. In the case of ODAS buoys, the phase characteristic used is group-flashing with a group of five flashes every 20 seconds.

731. IALA New Dangers

A newly discovered hazard to navigation not yet shown on charts, included in sailing directions, or announced by a *Notice to Mariners* is termed a **new danger**. The term covers naturally occurring and man-made obstructions.

Marking

A new danger is marked by one or more cardinal or lateral marks in accordance with the IALA system rules. If the danger is especially grave, at least one of the marks will be duplicated as soon as practicable by an identical mark until the danger has been sufficiently identified.

Lights

If a lighted mark is used for a new danger, it must exhibit a quick flashing or very quick flashing light. If a cardinal mark is used, it must exhibit a white light; if a lateral mark, a red or green light.

Racons

The duplicate mark may carry a Racon, Morse coded D, showing a signal length of 1 nautical mile on a radar display.

732. Chart Symbols and Abbreviations

Spar buoys and spindle buoys are represented by the same symbol; it is slanted to distinguish them from upright beacon symbols. The abbreviated description of the color of a buoy is given under the symbol. Where a buoy is colored in bands, the colors are indicated in sequence from the top. If the sequence of the bands is not known, or if the buoy is striped, the colors are indicated with the darker color first.

Topmarks

Topmark symbols are solid black (except when the topmark is red).

Lights

The period of the light of a cardinal mark is determined

by its quadrant and its flash characteristic (either quick-flashing or a very quick-flashing). The light's period is less important than its phase characteristic. Where space on charts is limited, the period may be omitted.

Light Flares

Magenta light-flares are normally slanted and inserted with their points adjacent to the position circles at the base of the symbols so the flare symbols do not obscure the topmark symbols.

Automatic Identification System (AIS)

Magenta circle with AIS text to the Navigation Aid depicts the existence of an AIS station. These aids broadcast their presence, identity, position and status at least every three minutes or as needed. These broadcasts can originate from a station located on an existing physical aid to navigation or from another location. A Virtual AIS is electronically charted, but non-existent as a physical aid to navigation.

Radar Reflectors

According to IALA rules, radar reflectors are not necessarily charted for several reasons. First, all major buoys are fitted with radar reflectors. It is also necessary to reduce the size and complexity of buoy symbols and associated legends. Finally, it is understood that, in the case of cardinal buoys, buoyage authorities place the reflector so that it cannot be mistaken for a topmark.

The symbols and abbreviations of the IALA Maritime Buoyage System may be found in *U.S. Chart No. 1* and in foreign equivalents.

UNITED STATES AIDS TO NAVIGATION SYSTEM (USATONS)

733. General U.S. Aids to Navigation System

The United States has adopted the major features of the IALA system, consistent with Region B for the United States Aids to Navigation System (USATONS).

The primary objective of the USATONS is to mitigate transit risks to promote the safe, economic, and efficient movement of military, commercial, and other vessels by assisting navigators in determining their position, a safe course, and warning them of dangers and obstructions.

Colors

Under this system, green buoys and beacons with green square dayboards mark a channel or waterway's port (left) side when entering port from sea and obstructions which must be passed by keeping the aid to navigation to port. Red buoys and beacons with red triangle dayboards mark a channel or waterway's starboard (right) side when entering port from sea and obstructions which must be passed by keeping the aid to navigation to starboard. Hence the phrase *Red Right Returning*.

Red and green horizontally banded **preferred channel** buoys and beacons (see Figure 733a) with red and green horizontally banded dayboards mark junctions or bifurcations in a channel or obstructions which may be passed on either side. If the topmost band is green, then the preferred channel will be followed by keeping the aid to navigation to port when entering port from sea. If the topmost band is red, then the preferred channel will be followed by keeping the aid to navigation to starboard when entering port from sea.

Red and white vertically striped **safe water** buoys and beacons (see Figure 733b) with red and white vertically striped dayboards mark a fairway or mid-channel.

Reflective material is placed on buoys and beacon dayboards to assist in their detection at night with a searchlight. The color of the reflective material agrees with the aid to navigation color. Red or green reflective material may be placed on preferred channel (junction) ATON; red if topmost band is red, or green if the topmost band is green. White reflective material is used on safe water ATON. Special purpose buoys beacons display yellow reflective material. Warning or regulatory buoys and beacons display orange reflective



Figure 733a. Preferred channel or “junction” buoy.



Figure 733b. Safe water buoy.

horizontal bands and a warning symbol.

Shapes

Certain unlighted buoys are differentiated by shape. Red buoys and red and green horizontally banded buoys with the topmost band red are cone-shaped buoys called **nuns**. Green buoys and green and red horizontally banded buoys with the topmost band green are cylinder-shaped buoys called **cans**.

Unlighted red and white vertically striped buoys may be pillar shaped or spherical. Lighted buoys, sound buoys, and spar buoys are not differentiated by shape to indicate the side on which they should be passed. Their purpose is indicated not by shape but by the color, number, or light characteristics.

Beacon dayboards also have shape significance. Red boards are triangle-shaped and green boards are square. Safe water beacons are marked with octagonal-shaped red and white vertically colored boards. A range is marked with rectangular-shaped board vertically striped (one color running down the center flanked by another color - a red board with a white center stripe for example).

There are also diamond-shaped special purpose and square-shaped information and regulatory boards.

Numbers

All solid colored buoys and beacons are numbered, red ATON exhibiting even numbers and green ATON odd numbers. The number values increase from seaward upstream or toward land. Other multiple colored ATON are not numbered but they may exhibit a letter for identification. In fact any ATON may be assigned a letter for identification.

Light Colors

Red lights are used only on red or red and green horizontally banded buoys and beacons with red triangle-shaped dayboards or horizontally banded triangle-shaped dayboards with red being the topmost band.

Green lights are used only on the green buoys or green and red horizontally banded buoys with the topmost band green and beacons with green square-shaped dayboards or green and red horizontally banded square-shaped dayboards with the green as the topmost band.

White lights are used on **safe water** buoys and beacons showing a Morse Code “A” characteristic and on Information and Regulatory buoys and beacons

Light Characteristics

Lights on red buoys or green buoys, if not occulting or isophase, will generally be regularly flashing (Fl). For ordinary purposes, the frequency of flashes will be not more than 50 flashes per minute. Lights with a distinct cautionary significance, such as at sharp turns or marking dangerous obstructions, will flash not less than 50 flashes but not more than 80 flashes per minute (quick flashing, Q). Lights on preferred channel buoys will show a series of group flashes with successive groups in a period having a different number of flashes - composite group flashing (or a quick light in which the sequence of flashes is interrupted by regularly repeated eclipses of constant and long duration). Lights on safe water buoys will always show a white Morse Code “A” (Short-Long) flash recurring at the rate of approximately eight times per minute.

Special Purpose Buoys

Buoys for special purposes are colored yellow. White buoys with orange bands are for informational or regulatory purposes. The shape of special purpose buoys has no significance.

They are not numbered, but they may be lettered. If lighted, special purpose buoys display a yellow light usually with fixed or slow flash characteristics. Information and regulatory buoys, if lighted, display white lights.

734. Intracoastal Waterway Aids to Navigation

The Intracoastal Waterway (ICW) consists of three non-contiguous segments: The Atlantic Coast Intracoastal Waterway - from Manasquan Inlet, New Jersey to Florida Bay, Florida; Florida Gulf Intracoastal Waterway - from Fort Myers to Tarpon Springs, Florida; and Gulf Intracoastal Waterway - from Carrabelle, Florida to Port Brownsville, Texas near the U.S. border with Mexico. The ICW includes about 3,000 miles of navigable waterways using sounds, bays, rivers, sloughs, estuaries, and other natural waterway features connected as necessary with dredged channels and canals.

There is a fourth ICW segment that runs across Florida for about 150 miles from St. Lucie Inlet to Fort Myers, Florida, but it is quite shallow and not recommended for most commercial traffic.

Aids to Navigation marking the ICW are numbered clockwise along the Atlantic and Gulf Coast and display distinctive yellow retro-reflective bands, squares, and triangles.

Red buoys and beacons with red triangle-shaped dayboards, with a yellow triangle affixed and even numbers mark the starboard (right) side of the ICW channel when traveling in a general clockwise direction along the coast. Green buoys and beacons with green square-shaped dayboards, with a yellow square affixed, and odd numbers mark the port (left) side of the ICW channel. Non-lateral aids to navigation, such as safe water marks, isolated danger marks, and front range boards are marked with a horizontal yellow band. Rear range boards do not display the yellow band. Where the ICW intersects with another U.S. Federal-maintained channel, the ICW yellow triangle or square affixed to the buoy or dayboard will indicate the ICW channel. Junctions between the ICW and privately maintained waterways are not marked with preferred channel buoys or beacons.

735. U.S. Western Rivers

The term Western Rivers includes the Mississippi River System, i.e. the Mississippi River from Lower Mississippi River Mile 155 to Upper Mississippi River Mile 857. In addition, the Western River System includes either in whole or portions of the Alabama, Arkansas, Black Warrior, Green, Missouri, Monongahela, Ohio, and

Tennessee Rivers, the Tennessee-Tombigbee Waterway, and various other associated rivers and waterways.

The aids to navigation system marking the Western Rivers System conforms with Region B of the IALA Maritime Buoyage System with the following variations:

1. Buoys are not numbered and shore structures are not numbered laterally Buoys are not numbered.
2. Numbers on shore structures indicate mileage from a designated point (normally the river mouth).
3. Diamond-shaped non-lateral daymarks, red/white or green/white as appropriate, are used instead of triangular or square lateral daymarks where the river channel crosses from one bank to the other.
4. The conventional direction of buoyage, for the purpose of installing the proper aid signals, is upstream. Local terminology, however, refers to the "left" and "right" banks viewed from a vessel proceeding downstream.
5. Lights on the right descending bank show single flashing rhythms and may be green or white. Lights on the left descending bank show "group-flashing-two" rhythms and may be red or white.
6. In pooled waters (behind dams), buoys set to mark the nine-foot contour for normal pool elevations.
7. In unstable waters (free-flowing rivers), buoys are set to mark the project depth (12-foot contour) for the prevailing river stage.
8. Isolated danger marks are not used.

736. State Waterways Aids to Navigation System

In accordance with Title 33 of the Code of Federal Regulations, Subpart 66.05 - State Aids to Navigation:

"With the exception on the provisions of subpart 66.10, which are valid until December 31, 2003, aids to navigation must be in accordance with the United States Aids to Navigation System in part 62 of this subchapter."

Therefore, the Uniform State Waterway Marking System (USWMS) is no longer a recognized aid to navigation system within any U.S. waterway, federal or state. Specifications for the superannuated USWMS can still be view in 33 CFR 66.10-15.

737. Private Aids to Navigation

Private Aids to Navigation (PATON) are those aids to navigation established, operated, and maintained by entities other than the Coast Guard, U.S. Armed Forces, or State authorities. There are three classes of PATON:

1. Class I: Aids to navigation on marine structures or other works which the owners are legally obligated to establish, maintain and operate as prescribed by the Coast Guard.
2. Class II: Aids to navigation exclusive of Class I located in waters used by general navigation.

3. Class III: Aids to navigation exclusive of Class I located in waters not ordinarily used by general navigation. Buoys are not numbered and shore structures are not numbered laterally Buoys are not numbered.

Per 33 CFR 66.01-1, “No person, public body, or instrumentality not under the control of the Commandant, exclusive of the Armed Forces, will establish and maintain, discontinue, change or transfer ownership of any aid to maritime navigation, without first obtaining permission to do so from the Commandant”, i.e. the Coast Guard.

In addition to Coast Guard approval, per 33 CFR 66.01-30, “Before any private aid to navigation consisting of a fixed structure [beacon] is placed in the navigable waters of the United States, authorization to erect such structure shall first be obtained from the District Engineer, U.S. Army Corps of Engineers in whose district the aid will be located.”

The characteristics of a private aid to navigation must conform to those prescribed by the United States Aids to Navigation System.

Private ATON owners are responsible for maintaining their PATON, which are subject to inspection by the Coast Guard at any time without prior notice

In addition to private aids to navigation, numerous types of construction and anchor buoys are used in various oil drilling operations and marine construction. These buoys are not charted, as they are temporary, and may not be lighted well or at all. Mariners should give a wide berth

to drilling and construction sites to avoid the possibility of fouling moorings. This is a particular danger in offshore oil fields, where large anchors are often used to stabilize the positions of drill rigs in deep water. Up to eight anchors may be placed at various positions as much as a mile from the drill ship. These positions may or may not be marked by buoys. Such operations in the U.S. are announced in the *Local Notice to Mariners*.

738. Interference with or damage to Aids to Navigation

Per 33 CFR 70, “No person, excluding the Armed Forces, shall obstruct or interfere with any aid to navigation established and maintained by the Coast Guard, or any private aid to navigation...”

Subpart §70.01-5 states: “Any person violating the provisions of this section shall be deemed guilty of a misdemeanor and be subject to a fine not exceeding the sum of \$500 for each offense, and each day during which such violation shall continue shall be considered a new offense.”

If any vessel collides with an aid to navigation, the person in charge of the vessel is required by law to report the accident to the Officer in Charge of the nearest Coast Guard Marine Inspection unit.

739. U. S. ATONS Graphics

See Figure 737b and Figure 737a for plates to the U.S. Aids to Navigation System (on navigable waters, including the Western River System).

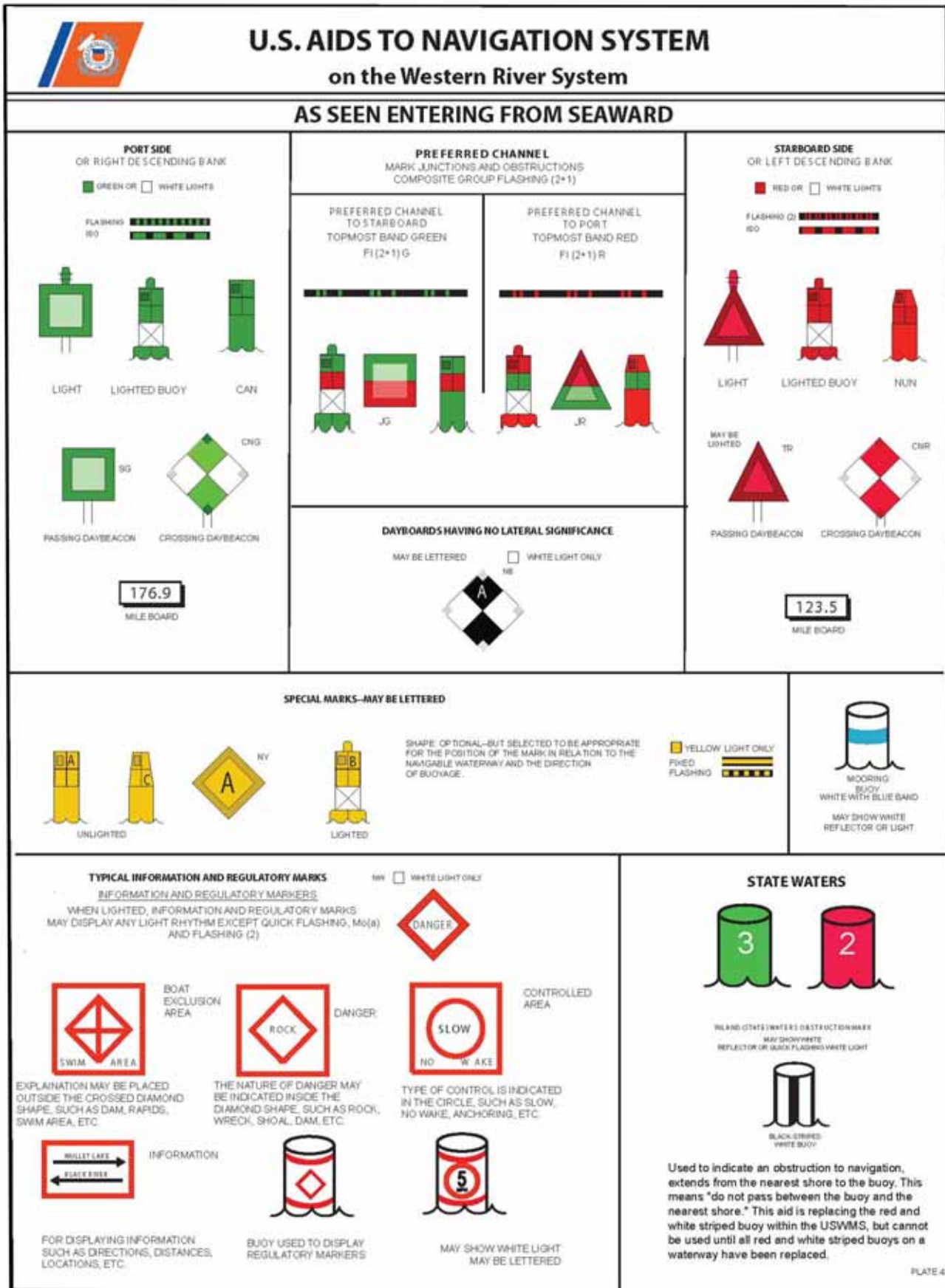

Figure 737a. U.S. Aids to Navigation - Plate 4.

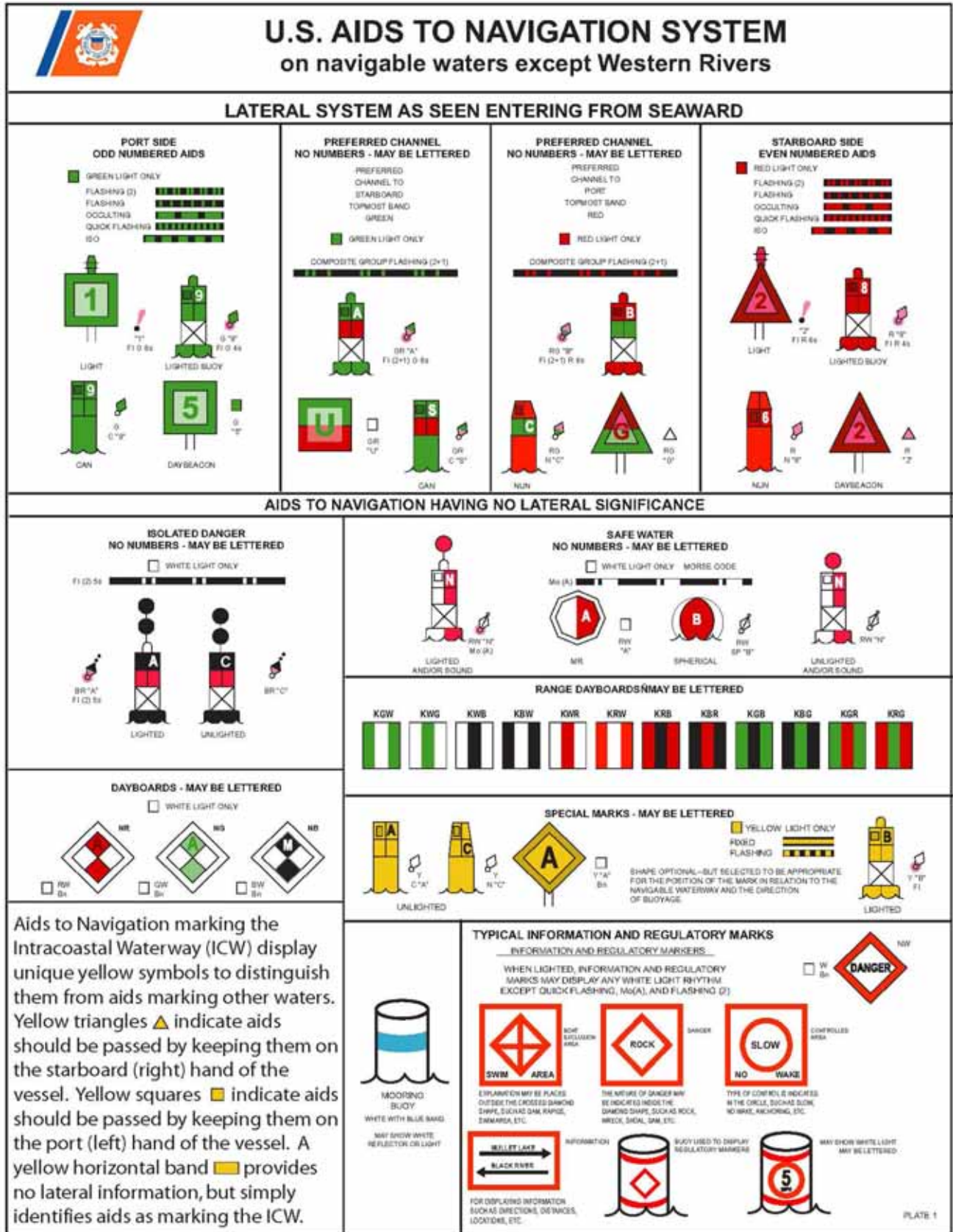

Figure 737b. U.S. Aids to Navigation - Plate 1.

CHAPTER 8

COMPASSES

INTRODUCTION

800. Changes in Compass Technologies

This chapter discusses the major types of compasses available to the navigator, their operating principles, their capabilities, and limitations of their use. As with other aspects of navigation, technology is rapidly revolutionizing the field of compasses.

For much of maritime history the sole heading reference for navigators has been the magnetic compass. However, a great deal of effort and expense has gone into understanding the magnetic compass scientifically to make it as accurate as possible through research and development of elaborate compensation techniques.

Over time, technological advances like the development of more sophisticated means for obtaining accurate compass readings, such as the electro-mechanical gyrocompass, diminished traditional reliance upon the magnetic compass, relegating it to backup status in many large vessels. Later came the development of inertial navigation systems based on gyroscopic principles, but perturbations like the interruption of electrical power to the gyrocompass or inertial navigator, mechanical failure, and equipment deterioration have reminded navigators of the important reliability of the magnetic compass.

New technologies are both refining and replacing the magnetic compass as the primary heading reference and navigational tool. Although using a magnetic compass for backup is certainly advisable, today's navigator can safely rely on modern equipment, avoiding much of the effort and expense associated with the binnacle-mounted magnetic compass, such as the need for compensation, adjustment, and maintenance.

Similarly, even relatively new advances like the electro-mechanical gyrocompasses are being supplanted by far lighter, cheaper, and more dependable ring laser gyrocompasses. These devices do not operate on the principle of the gyroscope (which is based on Newton's laws of motion), but instead rely on the principles of electromagnetic energy and wave theory.

Magnetic flux gate compasses, while relying on the Earth's magnetic field for reference, have no moving parts and can compensate themselves, adjusting for both deviation and variation to provide true heading, thus completely eliminating the process of compass correction.

To the extent that one depends on the magnetic compass for navigation, it should be checked regularly and adjusted when observed errors exceed certain minimal limits, usually a few degrees for most vessels. Compensation of a magnetic compass aboard vessels where navigators are expected to rely on it offshore or during long voyages is best left to professionals. However, this chapter will present enough material for the competent navigator to do an adequate job.

Whatever type of compass being used for navigation, it is advisable to check it periodically against an error free reference to determine its error. This may be done when steering along any range during harbor and approach navigation, or by aligning any two charted objects to find the difference between their observed and charted bearings. When navigating offshore, the use of azimuths and amplitudes of celestial bodies is also an effective method; a subject covered in Chapter will also suffice, a subject covered in Chapter 15 - Azimuths and Amplitudes.

MAGNETIC COMPASSES

801. The Magnetic Compass and Magnetism

The principle of the present day magnetic compass is no different from that of the compasses used by ancient mariners. The magnetic compass consists of a magnetized needle, or an array of needles, allowed to rotate freely in the horizontal plane. The superiority of present-day magnetic compasses over ancient ones results from a better knowledge of the laws of magnetism and how it governs the behavior of the compass and from greater precision in

design and construction.

Any magnetized piece of metal will have regions of concentrated magnetism called **poles**. Any such magnet will have at least two poles of opposite polarity. Magnetic force (flux) lines connect one pole of such a magnet with the other pole. The number of such lines per unit area represents the intensity of the magnetic field in that area.

When two magnets are placed close to each other, the like poles will repel each other and the unlike poles will attract each other.

Magnetism can be either **permanent** or **induced**. A bar having permanent magnetism will retain its magnetism when it is removed from a magnetizing field. A bar having induced magnetism will lose its magnetism when removed from the magnetizing field. Whether or not a bar will retain its magnetism on removal from the magnetizing field will depend on the strength of that field, the degree of hardness of the iron (retentivity), and upon the amount of physical stress applied to the bar while in the magnetizing field. The harder the iron, the more permanent will be the magnetism acquired.

802. Terrestrial Magnetism

Consider the Earth as a huge magnet surrounded by lines of magnetic flux connecting its two **magnetic poles**. These magnetic poles are near, but not coincidental with, the Earth's geographic poles. Since the north seeking end of a compass needle is conventionally called the **north pole**, or **positive pole**, it must therefore be attracted to a **south pole**, or **negative pole**.

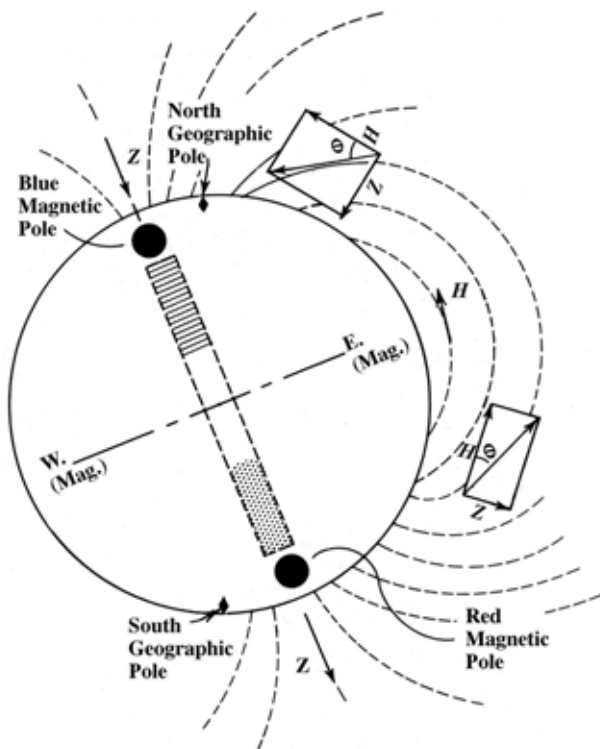

Figure 802a. Terrestrial magnetism.

Figure 802a illustrates the Earth and its surrounding magnetic field. The flux lines enter the surface of the Earth at different angles to the horizontal at different magnetic latitudes. This angle is called the **angle of magnetic dip**, θ , and increases from 0° at the magnetic equator to 90° at the magnetic poles. The total magnetic field is generally considered as having two components: H, the horizontal component; and Z, the vertical component. These compo-

nents change as the angle θ changes, such that H is at its maximum at the magnetic equator and decreases in the direction of either pole, while Z is zero at the magnetic equator and increases in the direction of either pole.

Since the magnetic poles of the Earth do not coincide with the geographic poles, a compass needle in line with the Earth's magnetic field will not indicate true north, but magnetic north. The angular difference between the true meridian (great circle connecting the geographic poles) and the magnetic meridian (direction of the lines of magnetic flux) is called **variation**. This variation has different values at different locations on the Earth. These values of magnetic variation may be found on pilot charts and on the compass rose of navigational charts. Magnetic variations is sometimes called magnetic **declination**.

The poles are not geographically static. They are known to migrate slowly, so that variation for most areas undergoes a small annual change, the amount of which is also noted on charts.

More information on geomagnetism is available at the U.S. Geological Survey (USGS) website: <http://geomag.usgs.gov/>.



Figure 802b. USGS Geomagnetism Program.

803. The World Magnetic Model

The World Magnetic Model is a joint product of the United States' National Geospatial-Intelligence Agency (NGA) and the United Kingdom's Defence Geographic Centre (DGC). The WMM was developed jointly by the National Geophysical Data Center (NGDC, Boulder CO, USA) (now the National Centers for Environmental Information (NCEI)) and the British Geological Survey (BGS, Edinburgh, Scotland).



Figure 803a. World Magnetic Model
<http://ngdc.noaa.gov/geomap/WMM>.

The World Magnetic Model is the standard model used by the U.S. Department of Defense, the U.K. Ministry of Defence, the North Atlantic Treaty Organization (NATO) and the International Hydrographic Organization (IHO), for

navigation, attitude and heading referencing systems using the geomagnetic field. It is also used widely in civilian navigation and heading systems. The model, associated software, and documentation are distributed by NCEI on

behalf of NGA. The model is produced at 5-year intervals, with the current model expiring on December 31, 2019. Figure 803b and Figure 803c show magnetic dip and variation (2015 epoch) for the world. Red contours are positive

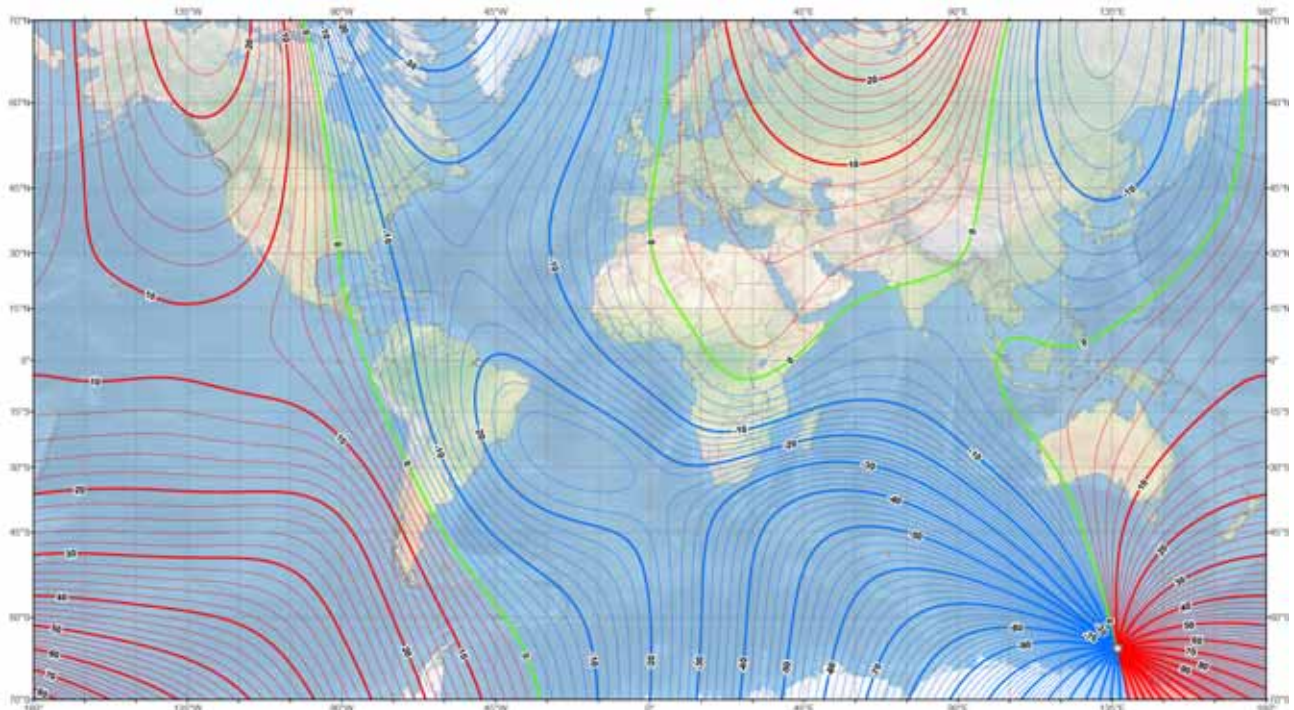

Figure 803b. Magnetic variation for the world (2015 Epoch).

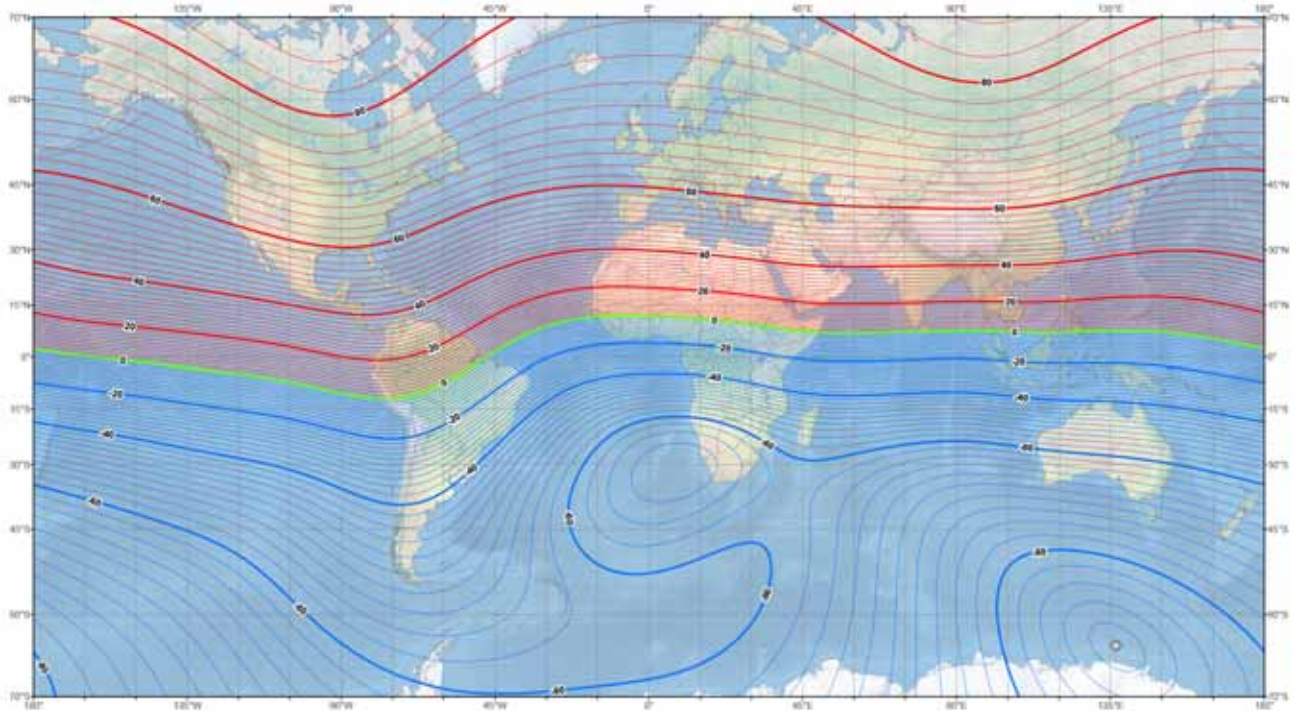

Figure 803c. Magnetic dip for the world (2015 Epoch).

or east, blue contours are negative or west and green is agonic or zero.

804. Ship's Magnetism

A ship under construction or repair will acquire permanent magnetism due to hammering and vibration while sitting stationary in the Earth's magnetic field. After launching, the ship will lose some of this original magnetism as a result of vibration and pounding in varying magnetic fields, and will eventually reach a more or less stable magnetic condition. The magnetism which remains is the **permanent magnetism** of the ship.

In addition to its permanent magnetism, a ship acquires **induced magnetism** when placed in the Earth's magnetic field. The magnetism induced in any given piece of soft iron is a function of the field intensity, the alignment of the soft iron in that field, and the physical properties and dimensions of the iron. This induced magnetism may add to, or subtract from, the permanent magnetism already present in the ship, depending on how the ship is aligned in the magnetic field. The softer the iron, the more readily it will be magnetized by the Earth's magnetic field, and the more readily it will give up its magnetism when removed from that field.

The magnetism in the various structures of a ship, which tends to change as a result of cruising, vibration, or aging, but which does not alter immediately so as to be properly termed induced magnetism, is called **subpermanent magnetism**. This magnetism, at any instant, is part of the ship's permanent magnetism, and consequently must be corrected by permanent magnet correctors. It is the principal cause of deviation changes on a magnetic compass. Subsequent reference to permanent magnetism will refer to the apparent permanent magnetism which includes the existing permanent and subpermanent magnetism.

A ship, then, has a combination of permanent, subpermanent, and induced magnetism. Therefore, the ship's apparent permanent magnetic condition is subject to change as a result of deperming, shocks, welding, and vibration. The ship's induced magnetism will vary with the Earth's magnetic field strength and with the alignment of the ship in that field.

805. Magnetic Adjustment

A narrow rod of soft iron, placed parallel to the Earth's horizontal magnetic field, H, will have a north pole induced in the end toward the north geographic pole and a south pole induced in the end toward the south geographic pole. This same rod in a horizontal plane, but at right angles to the horizontal Earth's field, would have no magnetism induced in it, because its alignment in the magnetic field precludes linear magnetization, if the rod is of negligible cross section. Should the rod be aligned in some horizontal direction between those headings which create maximum and zero induction, it would be induced by an amount which is a function of the angle of

alignment. However, if a similar rod is placed in a vertical position in northern latitudes so as to be aligned with the vertical Earth's field Z, it will have a south pole induced at the upper end and a north pole induced at the lower end. These polarities of vertical induced magnetization will be reversed in southern latitudes.

The amount of horizontal or vertical induction in such rods, or in ships whose construction is equivalent to combinations of such rods, will vary with the intensity of H and Z, heading, and heel of the ship.

The magnetic compass must be corrected for the vessel's permanent and induced magnetism so that its operation approximates that of a completely nonmagnetic vessel. Ship's magnetic conditions create magnetic compass deviations and sectors of sluggishness and unsteadiness. **Deviation** is defined as deflection right or left of the magnetic meridian caused by magnetic properties of the vessel. Adjusting the compass consists of arranging magnetic and soft iron **correctors** near the compass so that their effects are equal and opposite to the effects of the magnetic material in the ship.

The total permanent magnetic field effect at the compass may be broken into three components, mutually 90° to each other (see Figure 805a).

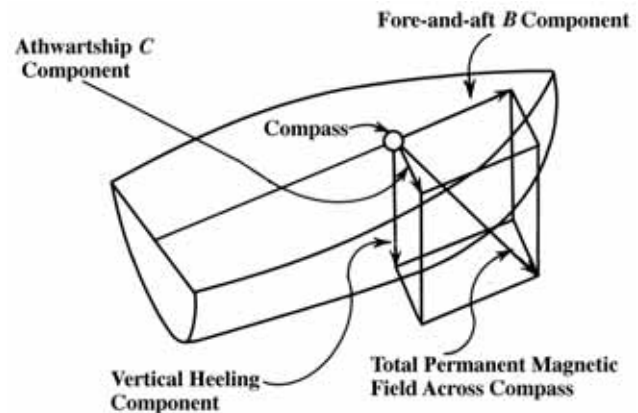

Figure 805a. Components of permanent magnetic field.

The vertical permanent component tilts the compass card, and, when the ship rolls or pitches, causes oscillating deflections of the card. Oscillation effects which accompany roll are maximum on north and south compass headings, and those which accompany pitch are maximum on east and west compass headings.

The horizontal B and C components of permanent magnetism cause varying deviations of the compass as the ship swings in heading on an even keel. Plotting these deviations against compass heading yields the sine and cosine curves shown in Figure 805b. These deviation curves are called semicircular curves because they reverse direction by 180° .

A vector analysis is helpful in determining deviations or the strength of deviating fields. For example, a ship as shown

in Figure 805c on an east magnetic heading will subject its compass to a combination of magnetic effects; namely, the Earth's horizontal field H , and the deviating field B , at right angles to the field H . The compass needle will align itself in the resultant field which is represented by the vector sum of H and B , as shown. A similar analysis will reveal that the resulting directive force on the compass would be maximum on a north heading and minimum on a south heading because the deviations for both conditions are zero. The magnitude of the deviation caused by the permanent B magnetic field will vary with different values of H ; hence, deviations resulting from permanent magnetic fields will vary with the magnetic latitude of the ship.

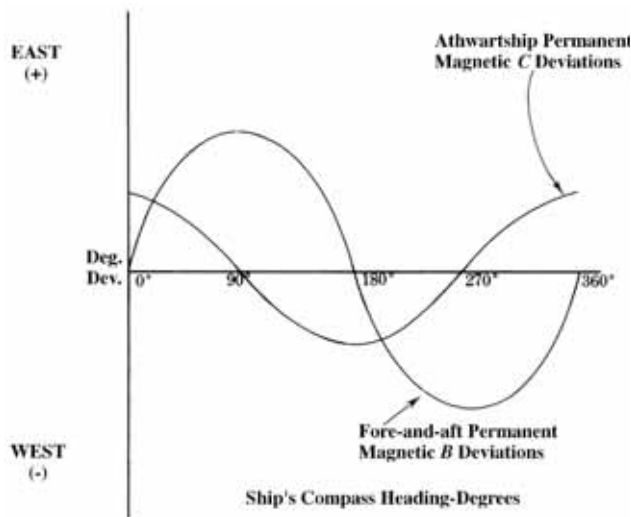

Figure 805b. Permanent magnetic deviation effects.

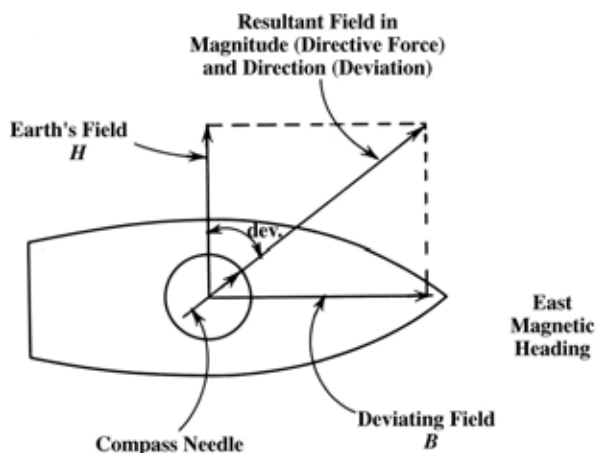

Figure 805c. General force diagram.

806. Effects of Induced Magnetism

Induced magnetism varies with the strength of the surrounding field, the mass of metal, and the alignment of the

metal in the field. Since the intensity of the Earth's magnetic field varies over the Earth's surface, the induced magnetism in a ship will vary with latitude, heading, and heeling angle.

With the ship on an even keel, the resultant vertical induced magnetism, if not directed through the compass itself, will create deviations which plot as a semicircular deviation curve. This is true because the vertical induction changes magnitude and polarity only with magnetic latitude and heel, and not with heading of the ship. Therefore, as long as the ship is in the same magnetic latitude, its vertical induced pole swinging about the compass will produce the same effect on the compass as a permanent pole swinging about the compass.

The Earth's field induction in certain other unsymmetrical arrangements of horizontal soft iron create a constant A deviation curve. In addition to this magnetic A error, there are constant A deviations resulting from: (1) physical misalignments of the compass, pelorus, or gyro; (2) errors in calculating the Sun's azimuth, observing time, or taking bearings.

The nature, magnitude, and polarity of these induced effects are dependent upon the disposition of metal, the symmetry or asymmetry of the ship, the location of the binnacle, the strength of the Earth's magnetic field, and the angle of dip.

Certain heeling errors, in addition to those resulting from permanent magnetism, are created by the presence of both horizontal and vertical soft iron which experience changing induction as the ship rolls in the Earth's magnetic field. This part of the heeling error will change in magnitude proportional to changes of magnetic latitude of the ship. Oscillation effects associated with rolling are maximum on north and south headings, just as with the permanent magnetic heeling errors.

807. Adjustments and Correctors

Since some magnetic effects are functions of the vessel's magnetic latitude and others are not, each individual effect should be corrected independently. Furthermore, to make the corrections, we use (1) permanent magnet correctors to compensate for permanent magnetic fields at the compass, and (2) soft iron correctors to compensate for induced magnetism. The compass binnacle provides support for both the compass and its correctors. Typical large ship binnacles hold the following correctors:

1. Vertical permanent **heeling magnet** in the central vertical tube directly beneath the compass.
2. Fore-and-aft **B permanent magnets** in their trays.
3. Athwartship **C permanent magnets** in their trays.
4. Vertical soft iron **Flinders bar** in its external tube.
5. Soft iron **quadrantal spheres**.

The heeling magnet is the only corrector which corrects for both permanent and induced effects. Therefore, it may need to be adjusted for changes in latitude if a vessel permanently changes its normal operating area. However, any movement of the heeling magnet will require readjust-

ment of other correctors.

Fairly sophisticated magnetic compasses used on smaller commercial craft, larger yachts, and fishing vessels, may not have soft iron correctors or B and C permanent magnets. These compasses are adjusted by rotating magnets located inside the base of the unit, adjustable by small screws on the outside. A non-magnetic screwdriver is necessary to adjust these compasses. Occasionally one may find a permanent magnet corrector mounted near the compass, placed during the initial installation so as to remove a

large, constant deviation before final adjustments are made. Normally, this remains in place for the life of the vessel.

Figure 807 summarizes all the various magnetic conditions in a ship, the types of deviation curves they create, the correctors for each effect, and headings on which each corrector is adjusted. When adjusting the compass, always apply the correctors symmetrically and as far away from the compass as possible. This preserves the uniformity of magnetic fields about the compass needle.

Coefficient	Type deviation curve	Compass headings of maximum deviation	Causes of such errors	Correctors for such errors	Magnetic or compass headings on which to apply correctors
A	Constant.	Same on all.	Human-error in calculations Physical-compass, gyro, pelorus alignment Magnetic-unsymmetrical arrangements of horiz. soft iron.	Check methods and calculations Check alignments Rare arrangement of soft iron rods.	Any.
B	Semicircular $\sin \phi$.	090° 270°	Fore-and-aft component of permanent magnetic field Induced magnetism in unsymmetrical vertical iron forward or aft of compass.	Fore-and-aft B magnets Flinders bar (forward or aft)	090° or 270°.
C	Semicircular $\cos \phi$.	000° 180°	Athwartship component of permanent magnetic field Induced magnetism in unsymmetrical vertical iron port or starboard of compass.	Athwartship C magnets Flinders bar (port or starboard)	000° or 180°.
D	Quadrantal $\sin 2\phi$.	045° 135° 225° 315°	Induced magnetism in all symmetrical arrangements of horizontal soft iron.	Spheres on appropriate axis. (athwartship for +D) (fore and aft for -D) <i>See sketch a</i>	045°, 135°, 225°, or 315°.
E	Quadrantal $\cos 2\phi$.	000° 090° 180° 270°	Induced magnetism in all unsymmetrical arrangements of horizontal soft iron.	Spheres on appropriate axis. (port fwd.-stb'd for +E) (stb'd fwd.-port aft for -E) <i>See sketch b</i>	000°, 090°, 180°, or 270°.
Heeling	Oscillations with roll or pitch. Deviations with constant list.	000° } roll 180° } 090° } 270° } h	Change in the horizontal component of the induced or permanent magnetic fields at the compass due to rolling or pitching of the ship.	Heeling magnet (must be readjusted for latitude changes).	090° or 270° with dip needle. 000° or 180° while rolling.

Deviation = $A + B \sin \phi + C \cos \phi + D \sin 2\phi + E \cos 2\phi$ (ϕ = compass heading)



Figure 807. Summary of compass errors and adjustments.

Occasionally, the permanent magnetic effects at the location of the compass are so large that they overcome the Earth's directive force, H. This condition will not only create sluggish and unsteady sectors, but may even freeze the compass to one reading or to one quadrant, regardless of the heading of the ship. Should the compass become so frozen, the polarity of the magnetism which must be attracting the compass needles is indicated; hence, correction may be effected simply by the application of permanent magnet correctors to neutralize this magnetism. Whenever such adjustments are made, the ship should be steered on a heading such that the unfreezing of the compass needles will be immediately evident. For example, a ship whose compass is frozen to a north reading would require fore-and-aft B corrector magnets with the positive ends forward in order to neutralize the existing negative pole which attracted the com-

pass. If made on an east heading, such an adjustment would be evident when the compass card was freed to indicate an east heading.

808. Reasons for Correcting Compass

There are several reasons for correcting the errors of a magnetic compass, even if it is not the primary directional reference:

1. It is easier to use a magnetic compass if the deviations are small.
2. Even known and fully compensated deviation introduces error because the compass operates sluggishly and unsteadily when deviation is present.

3. Even though the deviations are compensated for, they will be subject to appreciable change as a function of heel and magnetic latitude.

Theoretically, it doesn't matter what the compass error is as long as it is known. But a properly adjusted magnetic compass is more accurate in all sea conditions, easier to steer by, and less subject to transient deviations which could result in deviations from the ship's chosen course.

Therefore, if a magnetic compass is installed and meant to be relied upon, it behooves the navigator to attend carefully to its adjustment. Doing so is known as "swinging ship."

809. Adjustment Check-off List

While a professional compass adjuster will be able to obtain the smallest possible error curve in the shortest time, many ship's navigators adjust the compass themselves with satisfactory results. Whether or not a "perfect" adjustment is necessary depends on the degree to which the magnetic compass will be relied upon in day-to-day navigation. If the magnetic compass is only used as a backup compass, removal of every last possible degree of error may not be worthwhile. If the magnetic compass is the only steering reference aboard, as is the case with many smaller commercial craft and fishing vessels, it should be adjusted as accurately as possible.

Prior to getting underway to swing ship, the navigator must ensure that the process will proceed as expeditiously as possible by preparing the vessel and compass. The following tests and adjustment can be done at dockside, assuming that the compass has been installed and maintained properly. Initial installation and adjustment should be done by a professional compass technician during commissioning.

1. Check for bubbles in the compass bowl. Fluid may be added through the filling plug if necessary. Large bubbles indicate serious leakage, indicating that the compass should be taken to a professional compass repair facility for new gaskets. It is important to note that not all commercially available compass fluids are compatible with all compasses, especial compasses that were original alcohol-filled. Very early fluid-filled compasses from the late 1800's were filled with a mixture of alcohol and water. Compass oil became more commonly used after the 1940s. If unsure about the type of fluid, it is advisable to contact a professional before adding any.
2. Check for free movement of gimbals. Clean any dust or dirt from gimbal bearings and lubricate them as recommended by the maker.
3. Check for magnetization of the quadrantal spheres by moving them close to the compass and rotating

them. If the compass needle moves more than 2 degrees, the spheres must be annealed to remove their magnetism. Annealing consists of heating the spheres to a dull red color in a non-magnetic area and allowing them to cool slowly to ambient temperature.

4. Check for magnetization of the Flinders bar by inverting it, preferably with the ship on an E/W heading. If the compass needle moves more than 2 degrees the Flinders bar must be annealed.
5. Synchronize the gyro repeaters with the master gyro so courses can be steered accurately.
6. Assemble past documentation relating to the compass and its adjustment. Have the ship's degaussing folder ready.
7. Ensure that every possible metallic object is stowed for sea. All guns, doors, booms, and other movable gear should be in its normal seagoing position. All gear normally turned on such as radios, radars, loudspeakers, etc. should be on while swinging ship.
8. Have the International Code flags Oscar-Quebec ready to fly.

Once underway to swing ship, the following procedures will expedite the process. Choose the best helmsman aboard and instruct him to steer each course as steadily and precisely as possible. Each course should be steered steadily for at least two minutes before any adjustments are made to remove Gaussin error. Be sure the gyro is set for the mean speed and latitude of the ship.

The navigator (or compass adjuster if one is employed) should have a pelorus and a table of azimuths prepared for checking the gyro, but the gyrocompass will be the primary steering reference. Normally the adjuster will request courses and move the magnets as he or she feels necessary, a process much more of an intuitive art than a science. If a professional adjuster is not available, use the following sequence:

1. If there is a sea running, steer course 000° and adjust the heeling magnet to decrease oscillations to a minimum.
2. Come to course 090°. When steady on course 090°, for at least two minutes, insert, remove, or move fore-and-aft B magnets to remove ALL deviation.
3. Come to a heading of 180°. Insert, remove, or move athwartships C magnets to remove ALL deviation.
4. Come to 270° and move the B magnets to remove one half of the deviation.
5. Come to 000° and move the C magnets to remove one half of the deviation.

6. Come to 045° (or any intercardinal heading) and move the quadrantal spheres toward or away from the compass to minimize any error.
7. Come to 135° (or any intercardinal heading 90° from the previous course) and move the spheres in or out to remove one half of the observed error.
8. Steer the ship in turn on each cardinal and intercardinal heading around the compass, recording the error at each heading called for on the deviation card. If plotted, the errors should plot roughly as a sine curve about the 0° line.

If necessary, repeat steps 1-8. There is no average error, for each ship is different, but generally speaking, errors of more than a few degrees, or errors which seriously distort the sine curve, indicate a magnetic problem which should be addressed.

Once the compass has been swung, tighten all fittings and carefully record the placement of all magnets and correctors. Finally, swing for residual degaussed deviations with the degaussing circuits energized and record the deviations on the deviation card. Post this card near the chart table for ready reference by the navigation team.

Once properly adjusted, the magnetic compass deviations should remain constant until there is some change in the magnetic condition of the vessel resulting from magnetic treatment, shock, vibration, repair, or structural changes. Transient deviations are discussed below.

810. Sources of Transient Error

The ship must be in seagoing trim and condition to properly compensate a magnetic compass. Any movement of large metal objects or the energizing of any electrical equipment in the vicinity of the compass can cause errors. If in doubt about the effect of any such changes, temporarily move the gear or cycle power to the equipment while observing the compass card while on a steady heading. Preferably this should be done on two different headings 90° apart, since the compass might be affected on one heading and not on another.

Some magnetic items which cause deviations if placed too close to the compass are as follows:

1. Movable guns or weapon loads
2. Magnetic cargo
3. Hoisting booms
4. Cable reels
5. Metal doors in wheelhouse
6. Chart table drawers
7. Movable gyro repeater
8. Windows and ports
9. Signal pistols racked near compass
10. Sound powered telephones
11. Magnetic wheel or rudder mechanism
12. Knives or tools near binnacle

13. Watches, wrist bands, spectacle frames
14. Hat grommets, belt buckles, metal pencils
15. Heating of smoke stack or exhaust pipes
16. Landing craft

Some electrical items which cause variable deviations if placed too close to the compass are:

1. Electric motors
2. Magnetic controllers
3. Gyro repeaters
4. Nonmarried conductors
5. Loudspeakers
6. Electric indicators
7. Electric welding
8. Large power circuits
9. Searchlights or flashlights
10. Electrical control panels or switches
11. Telephone headsets
12. Windshield wipers
13. Rudder position indicators, solenoid type
14. Minesweeping power circuits
15. Engine order telegraphs
16. Radar equipment
17. Magnetically controlled switches
18. Radio transmitters
19. Radio receivers
20. Voltage regulators

Another source of transient deviation is the **retentive error**. This error results from the tendency of a ship's structure to retain induced magnetic effects for short periods of time. For example, a ship traveling north for several days, especially if pounding in heavy seas, will tend to retain some fore-and-aft magnetism induced under these conditions. Although this effect is transient, it may cause slightly incorrect observations or adjustments. This same type of error occurs when

HANDBOOK OF MAGNETIC
COMPASS ADJUSTMENT



NATIONAL
GEOGRAPHIC-INTelligence AGENCY
RESTON, VA



Figure 810. NGA Handbook of Magnetic Compass Adjustment (2004).

<https://msi.nga.mil/MSISiteContent/StaticFiles/HoMCA.pdf>

ships are docked on one heading for long periods of time. A

short shakedown, with the ship on other headings, will tend to remove such errors. A similar sort of residual magnetism is left in many ships if the degaussing circuits are not secured by the correct reversal sequence.

A source of transient deviation somewhat shorter in duration than retentive error is known as **Gaussin error**. This error is caused by eddy currents set up by a changing number of magnetic lines of force through soft iron as the ship changes heading. Due to these eddy currents, the induced magnetism on a given heading does not arrive at its normal value until about 2 minutes after changing course.

Deperming and other magnetic treatment will change

the magnetic condition of the vessel and therefore require compass readjustment. The decaying effects of deperming can vary. Therefore, it is best to delay readjustment for several days after such treatment. Since the magnetic fields used for such treatments are sometimes rather large at the compass locations, the Flinders bar, compass, and related equipment should be removed from the ship during these operations.

For more information on magnetic adjustment see NGA's Handbook of Magnetic Compass Adjustments via the link provided in Figure 810.

DEGAUSSING (MAGNETIC SILENCING) COMPENSATION

811. Degaussing

A steel vessel has a certain amount of **permanent magnetism** in its "hard" iron and **induced magnetism** in its "soft" iron. Whenever two or more magnetic fields occupy the same space, the total field is the vector sum of the individual fields. Thus, near the magnetic field of a vessel, the total field is the combined total of the Earth's field and the vessel's field. Not only does the Earth's field affect the vessel's, the vessel's field affects the Earth's field in its immediate vicinity.

Since certain types of explosive mines are triggered by the magnetic influence of a vessel passing near them, a vessel may use a degaussing system to minimize its magnetic field. One method of doing this is to neutralize each component of the field with an opposite field produced by electrical cables coiled around the vessel. These cables, when energized, counteract the permanent magnetism of the vessel, rendering it magnetically neutral. This has severe effects on magnetic compasses.

A unit sometimes used for measuring the strength of a magnetic field is the **gauss**. Reducing of the strength of a magnetic field decreases the number of gauss in that field. Hence, the process is called **degaussing**.

The magnetic field of the vessel is completely altered when the degaussing coils are energized, introducing large deviations in the magnetic compass. This deviation can be removed by introducing an equal and opposite force with energized coils near the compass. This is called **compass compensation**. When there is a possibility of confusion with compass adjustment to neutralize the effects of the natural magnetism of the vessel, the expression **degaussing compensation** is used. Since compensation may not be perfect, a small amount of deviation due to degaussing may remain on certain headings. This is the reason for swinging the ship with degaussing off and again with it on, and why there are two separate columns in the deviation table.

812. A Vessel's Magnetic Signature

A simplified diagram of the distortion of the Earth's magnetic field in the vicinity of a steel vessel is shown in Figure 812a. The field strength is directly proportional to the line spacing density. If a vessel passes over a device for detecting and recording the strength of the magnetic field, a certain pattern is traced. Figure 812b shows this pattern. Since the magnetic field of each vessel is different, each produces a distinctive trace. This distinctive trace is referred to as the vessel's **magnetic signature**.

Several **degaussing stations** have been established in major ports to determine magnetic signatures and recommend the current adjustments needed in the various degaussing coils to render the vessel magnetically neutral. Since a vessel's induced magnetism varies with heading and magnetic latitude, the current settings of the coils may sometimes need to be changed. A **degaussing folder** is provided to the vessel to indicate these changes and to document other pertinent information.

A vessel's permanent magnetism changes somewhat with time and the magnetic history of the vessel. Therefore, the data in the degaussing folder should be checked periodically at the magnetic station.

813. Degaussing Coils

For degaussing purposes, the total field of the vessel is divided into three components: (1) vertical, (2) horizontal fore-and-aft, and (3) horizontal athwartships. The positive (+) directions are considered downward, forward, and to port, respectively. These are the normal directions for a vessel headed north or east in north latitude.

Each component is opposed by a separate degaussing field just strong enough to neutralize it. Ideally, when this has been done, the Earth's field passes through the vessel smoothly and without distortion. The opposing degaussing fields are produced by direct current flowing in coils of wire. Each of the degaussing coils is placed so that the field it produces is directed to oppose one component of the

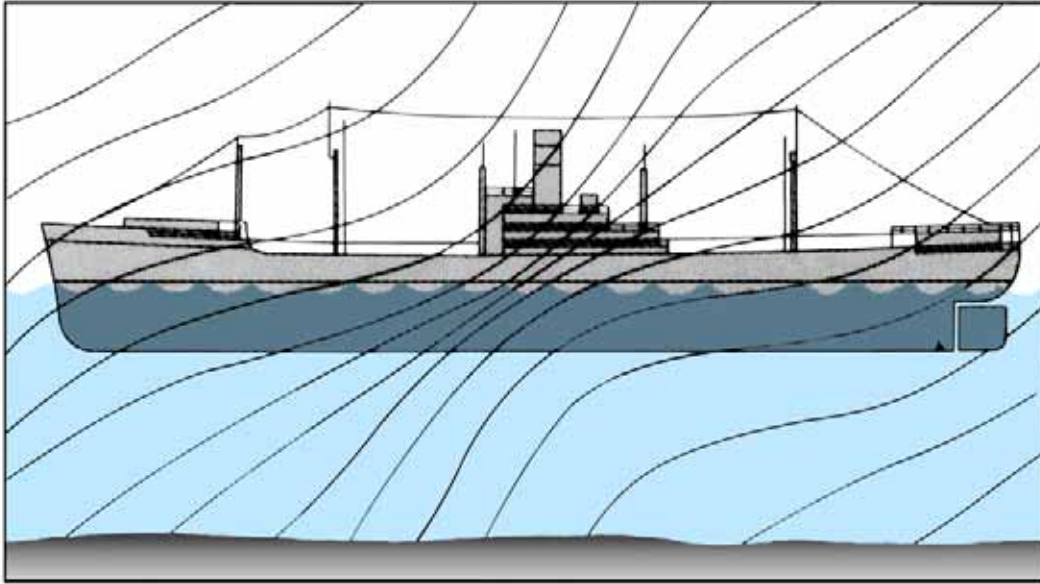

Figure 812a. Simplified diagram of distortion of Earth's magnetic field in the vicinity of a steel vessel.

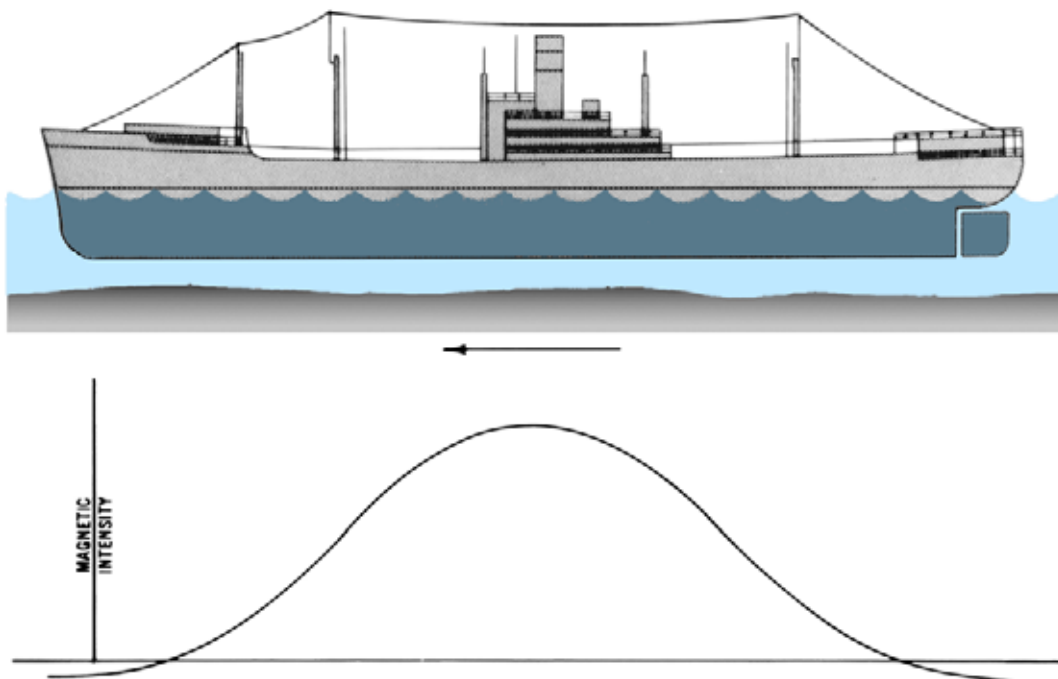

Figure 812b. A simplified signature of a vessel of Figure 812a.

ship's field.

The number of coils installed depends upon the magnetic characteristics of the vessel, and the degree of safety desired. The ship's permanent and induced magnetism may be neutralized separately so that control of induced magnetism can be varied as heading and latitude change, without disturbing the fields opposing the vessel's permanent field. The principal coils employed are the following:

Main (M) coil. The M coil is horizontal and

completely encircles the vessel, usually at or near the waterline. Its function is to oppose the vertical component of the vessel's combined permanent and induced fields. Generally the induced field predominates. Current in the M-coil is varied or reversed according to the change of the induced component of the vertical field with latitude.

Forecastle (F) and quarterdeck (Q) coils. The F and Q coils are placed horizontally just below the forward and after thirds (or quarters), respectively, of the weather deck. These coils, in which current can be individually adjusted,

remove much of the fore-and-aft component of the ship's permanent and induced fields. More commonly, the combined F and Q coils consist of two parts; one part the FP and QP coils, to take care of the permanent fore-and-aft field, and the other part, the FI and QI coils, to neutralize the induced fore-and-aft field. Generally, the forward and after coils of each type are connected in series, forming a split-coil installation and designated FP-QP coils and FI-QI coils. Current in the FP-QP coils is generally constant, but in the FI-QI coils is varied according to the heading and magnetic latitude of the vessel. In split-coil installations, the coil designations are often called simply the P-coil and I-coil.

Longitudinal (L) coil. Better control of the fore-and-aft components, but at greater installation expense, is provided by placing a series of vertical, athwartship coils along the length of the ship. It is the field, not the coils, which is longitudinal. Current in an L coil is varied as with the FI-QI coils. It is maximum on north and south headings, and zero on east and west headings.

Athwartship (A) coil. The A coil is in a vertical fore-and-aft plane, thus producing a horizontal athwartship field which neutralizes the athwartship component of the vessel's field. In most vessels, this component of the permanent field is small and can be ignored. Since the A-coil neutralizes the induced field, primarily, the current is changed with magnetic latitude and with heading, maximum on east or west headings, and zero on north or south headings.

The strength and direction of the current in each coil is indicated and adjusted at a control panel accessible to the navigator. Current may be controlled directly by rheostats at the control panel or remotely by push buttons which operate rheostats in the engine room.

Appropriate values of the current in each coil are determined at a degaussing station, where the various currents are adjusted until the vessel's magnetic signature is made as flat as possible. Recommended current values and directions for all headings and magnetic latitudes are set forth in the vessel's degaussing folder. This document is normally kept by the navigator, who must see that the recommended settings are maintained whenever the degaussing system is energized.

814. Securing The Degaussing System

Unless the degaussing system is properly secured, residual magnetism may remain in the vessel. During degaussing compensation and at other times, as recommended in the degaussing folder, the "reversal" method is used. The steps in the reversal process are as follows:

1. Start with maximum degaussing current used since the system was last energized.
2. Decrease current to zero and increase it in the opposite direction to the same value as in step 1.

3. Decrease the current to zero and increase it to three-fourths maximum value in the original direction.
4. Decrease the current to zero and increase it to one-half maximum value in the opposite direction.
5. Decrease the current to zero and increase it to one-fourth maximum value in the original direction.
6. Decrease the current to zero and increase it to one-eighth maximum value in the opposite direction.
7. Decrease the current to zero and open switch.

815. Magnetic Treatment Of Vessels

In some instances, degaussing can be made more effective by changing the magnetic characteristics of the vessel by a process known as **deperming**. Heavy cables are wound around the vessel in an athwartship direction, forming vertical loops around the longitudinal axis of the vessel. The loops are run beneath the keel, up the sides, and over the top of the weather deck at closely spaced equal intervals along the entire length of the vessel. Predetermined values of direct current are then passed through the coils. When the desired magnetic characteristics have been acquired, the cables are removed.

A vessel which does not have degaussing coils, or which has a degaussing system that is inoperative, can be given some temporary protection by a process known as **flashing**. A horizontal coil is placed around the outside of the vessel and energized with large predetermined values of direct current. When the vessel has acquired a vertical field of permanent magnetism of the correct magnitude and polarity to reduce to a minimum the resultant field below the vessel for the particular magnetic latitude involved, the cable is removed. This type protection is not as satisfactory as that provided by degaussing coils because it is not adjustable for various headings and magnetic latitudes, and also because the vessel's magnetism slowly readjusts following treatment.

During magnetic treatment all magnetic compasses and Flinders bars should be removed from the ship. Permanent adjusting magnets and quadrantal correctors are not materially affected, and need not be removed. If it is impractical to remove a compass, the cables used for magnetic treatment should be kept as far as practical from it.

816. Degaussing Effects

The degaussing of ships for protection against magnetic influence mines creates additional effects upon magnetic compasses, which are somewhat different from the permanent and induced magnetic effects. The degaussing effects are electromagnetic, and depend on:

1. Number and type of degaussing coils installed.
2. Magnetic strength and polarity of the degaussing coils.
3. Relative location of the different degaussing coils

with respect to the binnacle.

4. Presence of masses of steel, which would tend to concentrate or distort magnetic fields in the vicinity of the binnacle.
5. The fact that degaussing coils are operated intermittently, with variable current values, and with different polarities, as dictated by necessary degaussing conditions.

817. Degaussing Compensation

The magnetic fields created by the degaussing coils would render the vessel's magnetic compasses useless unless compensated. This is accomplished by subjecting the compass to compensating fields along three mutually perpendicular axes. These fields are provided by small **compensating coils** adjacent to the compass. In nearly all installations, one of these coils, the **heeling coil**, is horizontal and on the same plane as the compass card, providing a vertical compensating field. Current in the heeling coil is adjusted until the vertical component of the total degaussing field is neutralized. The other compensating coils provide horizontal fields perpendicular to each other. Current is varied in these coils until their resultant field is equal and opposite to the horizontal component of the degaussing field. In early installations, these horizontal fields were directed fore-and-aft and athwartships by placing the coils around the Flinders bar and the quadrantal spheres. Compactness and other advantages are gained by placing the coils on perpendicular axes extending 045° - 225° and 315° - 135° relative to the heading. A frequently used compensating installation, called the **type K**, is shown in Figure 817. It consists of a heeling coil extending completely around the top of the binnacle, four **intercardinal coils**, and three control boxes. The intercardinal coils are named for their positions relative to the compass when the vessel is on a heading of north, and also for the compass headings on which the current in the coils is adjusted to the correct amount for compensation. The NE-SW coils operate together as one set, and the NW-SE coils operate as another. One control box is provided for each set, and one for the heeling coil.

The compass compensating coils are connected to the power supply of the degaussing coils, and the currents passing through the compensating coils are adjusted by series resistances so that the compensating field is equal to the degaussing field. Thus, a change in the degaussing currents is accompanied by a proportional change in the compensating currents. Each coil has a separate winding for each degaussing circuit it compensates.

Degaussing compensation is carried out while the vessel is moored at the shipyard where the degaussing coils are installed. This process is usually carried out by civilian professionals, using the following procedure:

Step 1. The compass is removed from its binnacle and

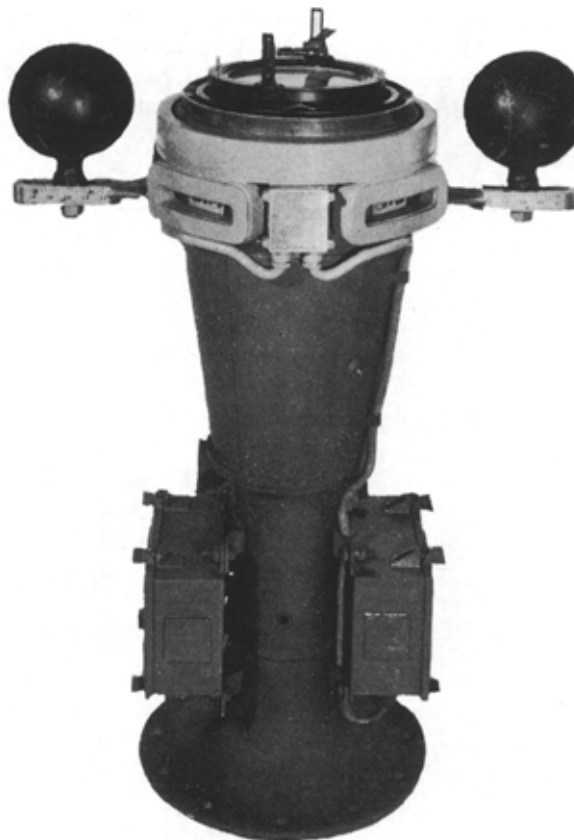

Figure 817. Type K degaussing compensation installation.

a dip needle is installed in its place. The M coil and heeling coil are then energized, and the current in the heeling coil is adjusted until the dip needle indicates the correct value for the magnetic latitude of the vessel. The system is then secured by the reversing process.

Step 2. The compass is replaced in the binnacle. With auxiliary magnets, the compass card is deflected until the compass magnets are parallel to one of the compensating coils or set of coils used to produce a horizontal field. The compass magnets are then perpendicular to the field produced by that coil. One of the degaussing circuits producing a horizontal field, and its compensating winding, are then energized, and the current in the compensating winding is adjusted until the compass reading returns to the value it had before the degaussing circuit was energized. The system is then secured by the reversing process. The process is repeated with each additional circuit used to create a horizontal field. The auxiliary magnets are then removed.

Step 3. The auxiliary magnets are placed so that the compass magnets are parallel to the other compensating coils or set of coils used to produce a horizontal field. The procedure of step 2 is then repeated for each circuit producing a horizontal field.

When the vessel gets under way, it proceeds to a suitable maneuvering area. The vessel is then steered so that the compass magnets are parallel first to one compensating coil or set of coils, and then the other. Any needed adjustment is made in the compensating circuits to reduce the error to a minimum. The vessel is then swung for residual deviation, first with degaussing off and then with degaussing on, and the correct current settings determined for each heading at the magnetic latitude of the vessel. From the values thus obtained, the "DG OFF" and "DG ON" columns of the deviation table are filled in. If the results indicate satisfactory compensation, a record is made of the degaussing coil settings and the resistance, voltages, and currents in the compensating coil circuits. The control boxes are then secured.

Under normal operating conditions, the settings do not need to be changed unless changes are made in the degaussing system, or unless an alteration is made in the length of the Flinders bar or the setting of the quadrantal spheres. However, it is possible for a ground to occur in the coils or control box if the circuits are not adequately

protected from moisture. If this occurs, it should be reflected by a change in deviation with degaussing on, or by a decreased installation resistance. Under these conditions, compensation should be done again. If the compass will be used with degaussing on before the ship can be returned to a shipyard where the compensation can be made by experienced personnel, the compensation should be made at sea on the actual headings needed, rather than by deflection of the compass needles by magnets. More complete information related to this process is given in the degaussing folder.

If a vessel has been given magnetic treatment, its magnetic properties have changed, necessitating readjustment of each magnetic compass. This is best delayed for several days to permit the magnetic characteristics of the vessel to settle. If compensation cannot be delayed, the vessel should be swung again for residual deviation after a few days. Degaussing compensation should not be made until after compass adjustment has been completed.

GYROCOMPASSES

818. Principles of the Gyroscope

A gyroscope consists of a spinning wheel or rotor contained within gimbals which permit movement about three mutually perpendicular axes, known as the **horizontal axis**, the **vertical axis**, and the **spin axis**. When spun rapidly, assuming that friction is not considered, the gyroscope develops **gyroscopic inertia**, tending to remain spinning in the same plane indefinitely. The amount of gyroscopic inertia depends on the angular velocity, mass, and radius of the wheel or rotor.

When a force is applied to change alignment of the spin axis of a gyroscope, the resultant motion is perpendicular to the direction of the force. This tendency is known as precession. A force applied to the center of gravity of the gyroscope will move the entire system in the direction of the force. Only a force that tends to change the axis of rotation produces precession.

If a gyroscope is placed at the equator with its spin axis pointing east-west, as the Earth turns on its axis, gyroscopic inertia will tend to keep the plane of rotation constant. To the observer, it is the gyroscope which is seen to rotate, not the Earth. This effect is called the horizontal earth rate, and is maximum at the equator and zero at the poles. At points between, it is equal to the cosine of the latitude.

If the gyro is placed at a geographic pole with its spin axis horizontal, it will appear to rotate about its vertical axis. This is the vertical earth rate. At all points between the equator and the poles, the gyro appears to turn partly about its horizontal and partly about its vertical axis, being affected by both horizontal and vertical earth rates. In order to visualize these effects, remember that the gyro, at

whatever latitude it is placed, is remaining aligned in space while the Earth moves beneath it.

819. Gyrocompass Operation

The gyrocompass depends upon four natural phenomena: gyroscopic inertia, precession, Earth's rotation, and gravity. To make a gyroscope into a gyrocompass, the wheel or rotor is mounted in a sphere, called the gyrosphere, and the sphere is then supported in a vertical ring. The whole is mounted on a base called the phantom. The gyroscope in a gyrocompass can be pendulous or non-pendulous, according to design. The rotor may weigh as little as half a kilogram to over 25 kg.

To make it seek and maintain true north, three things are necessary. First, the gyro must be made to stay on the plane of the meridian. Second, it must be made to remain horizontal. Third, it must stay in this position once it reaches horizontal regardless what the vessel on which it is mounted does or where it goes on the Earth. To make it seek the meridian, a weight is added to the bottom of the vertical ring, causing it to swing on its vertical axis, and thus seek to align itself horizontally. It will tend to oscillate, so a second weight is added to the side of the sphere in which the rotor is contained, which dampens the oscillations until the gyro stays on the meridian. With these two weights, the only possible position of equilibrium is on the meridian with its spin axis horizontal.

To make the gyro seek north, a system of reservoirs filled with mercury, known as mercury ballistics, is used to apply a force against the spin axis. The ballistics, usually four in number, are placed so that their centers of gravity

exactly coincide with the CG of the gyroscope. Precession then causes the spin axis to trace an ellipse, one ellipse taking about 84 minutes to complete. (This is the period of oscillation of a pendulum with an arm equal to the radius of the Earth.) To dampen this oscillation the force is applied, not in the vertical plane, but slightly to the east of the vertical plane. This causes the spin axis to trace a spiral instead of an ellipse and eventually settle on the meridian pointing north.

820. Gyrocompass Errors

The total of the all the combined errors of the gyrocompass is called **gyro error** and is expressed in degrees E or W, just like variation and deviation. But gyro error, unlike magnetic compass error, and being independent of Earth's magnetic field, will be constant in one direction; that is, an error of one degree east will apply to all bearings all around the compass.

The errors to which a gyrocompass is subject are speed error, latitude error, ballistic deflection error, ballistic damping error, quadrantal error, and gimbaling error. Additional errors may be introduced by a malfunction or incorrect alignment with the centerline of the vessel.

Speed error is caused by the fact that a gyrocompass only moves directly east or west when it is stationary (on the rotating Earth) or placed on a vessel moving exactly east or west. Any movement to the north or south will cause the compass to trace a path which is actually a function of the speed of advance and the amount of northerly or southerly heading. This causes the compass to tend to settle a bit off true north. This error is westerly if the vessel's course is northerly, and easterly if the course is southerly. Its magnitude depends on the vessel's speed, course, and latitude. This error can be corrected internally by means of a cosine cam mounted on the underside of the azimuth gear, which removes most of the error. Any remaining error is minor in amount and can be disregarded.

Tangent latitude error is a property only of gyros with mercury ballistics, and is easterly in north latitudes and westerly in south latitudes. This error is also corrected internally, by offsetting the lubber's line or with a small movable weight attached to the casing.

Ballistic deflection error occurs when there is a marked change in the north-south component of the speed. East-west accelerations have no effect. A change of course or speed also results in speed error in the opposite direction, and the two tend to cancel each other if the compass is properly designed. This aspect of design involves slightly offsetting the ballistics according to the operating latitude, upon which the correction is dependent. As latitude changes, the error becomes apparent, but can be minimized by adjusting the offset.

Ballistic damping error is a temporary oscillation introduced by changes in course or speed. During a change in course or speed, the mercury in the ballistic is subjected

to centrifugal and acceleration/deceleration forces. This causes a torquing of the spin axis and subsequent error in the compass reading. Slow changes do not introduce enough error to be a problem, but rapid changes will. This error is counteracted by changing the position of the ballistics so that the true vertical axis is centered, thus not subject to error, but only when certain rates of turn or acceleration are exceeded.

Quadrantal error has two causes. The first occurs if the center of gravity of the gyro is not exactly centered in the phantom. This causes the gyro to tend to swing along its heavy axis as the vessel rolls in the sea. It is minimized by adding weight so that the mass is the same in all directions from the center. Without a long axis of weight, there is no tendency to swing in one particular direction. The second source of quadrantal error is more difficult to eliminate. As a vessel rolls in the sea, the apparent vertical axis is displaced, first to one side and then the other. The vertical axis of the gyro tends to align itself with the apparent vertical. On northerly or southerly courses, and on easterly or westerly courses, the compass precesses equally to both sides and the resulting error is zero. On intercardinal courses, the N-S and E-W precessions are additive, and a persistent error is introduced, which changes direction in different quadrants. This error is corrected by use of a second gyroscope called a floating ballistic, which stabilizes the mercury ballistic as the vessel rolls, eliminating the error. Another method is to use two gyros for the directive element, which tend to precess in opposite directions, neutralizing the error.

Gimbaling error is caused by taking readings from the compass card when it is tilted from the horizontal plane. It applies to the compass itself and to all repeaters. To minimize this error, the outer ring of the gimbal of each repeater should be installed in alignment with the fore-and-aft line of the vessel. Of course, the lubber's line must be exactly centered as well.

821. Using the Gyrocompass

Since a gyrocompass is not influenced by magnetism, it is not subject to variation or deviation. Any error is constant and equal around the horizon, and can often be reduced to less than one degree, thus effectively eliminating it altogether. Unlike a magnetic compass, it can output a signal to repeaters spaced around the vessel at critical positions.

But it also requires a constant source of stable electrical power, and if power is lost, it requires several hours to settle on the meridian again before it can be used. This period can be reduced by aligning the compass with the meridian before turning on the power.

The directive force of a gyrocompass depends on the amount of precession to which it is subject, which in turn is dependent on latitude. Thus the directive force is maximum at the equator and decreases to zero at the poles. Vessels

operating in high latitudes must construct error curves based on latitudes because the errors at high latitudes eventually overcome the ability of the compass to correct them.

The gyrocompass is typically located below decks as close as possible to the center of roll, pitch and yaw of the ship, thus minimizing errors caused by the ship's motion. Repeaters are located at convenient places throughout the ship, such as at the helm for steering, on the bridge wings for taking bearings, in after steering for emergency steering,

and other places. The output can also be used to drive course recorders, autopilot systems, plotters, fire control systems, and stabilized radars. The repeaters should be checked regularly against the master to ensure they are all in alignment. The repeaters on the bridge wing used for taking bearings will likely be equipped with removable bearing circles, azimuth circles, and telescopic alidades, which allow one to sight a distant object and see its exact gyrocompass bearing.

ELECTRONIC COMPASSES

822. New Direction Sensing Technologies

The magnetic compass has considerable limitations, chiefly that of being unable to isolate the earth's magnetic field from all others close enough to influence it. It also indicates magnetic north, whereas the mariner is most interested in true north. Most of the work involved with compensating a traditional magnetic compass involves neutralizing magnetic influences other than the Earth's, a complicated and inexact process often involving more art than science. Residual error is almost always present even after compensation. Degaussing complicates the situation immensely.

The electro-mechanical gyrocompass has been the standard steering and navigational compass since the early 20th century, and has provided several generations of mariners a stable and reliable heading and bearing reference. However, it too has limitations: It is a large, expensive, heavy, sensitive device that must be mounted according to rather strict limitations. It requires a stable and uninterrupted supply of electrical power; it is sensitive to shock, vibration, and environmental changes; and it needs several hours to settle after initialization.

Fortunately, several new technologies have been developed which promise to greatly reduce or eliminate the complications brought on by the limitations of both the mechanical gyroscope and traditional magnetic compasses. Sometimes referred to as "electronic compasses," the digital flux gate magnetic compass and the ring laser gyrocompass are two such devices. They have the following advantages:

1. Solid state electronics, no moving parts
2. Operation at very low power
3. Easy backup power from independent sources
4. Standardized digital output
5. Zero friction, drift, or wear
6. Compact, lightweight, and inexpensive
7. Rapid start-up and self-alignment
8. Low sensitivity to vibration, shock, and temperature changes
9. Self-correcting

Both types are being installed in many vessels as the primary directional reference, enabling the decommissioning of the traditional magnetic compasses and the avoidance of periodic compensation and maintenance.

823. The Flux Gate Compass

The most widely used sensor for digital compasses is the flux-gate magnetometer, developed around 1928. Initially it was used for detecting submarines, for geophysical prospecting, and airborne mapping of Earth's magnetic fields.

The most common type, called the second harmonic device, incorporates two coils, a primary and a secondary, both wrapped around a single highly permeable ferromagnetic core. In the presence of an external magnetic field, the core's magnetic induction changes. A signal applied to the primary winding causes the core to oscillate. The secondary winding emits a signal that is induced through the core from the primary winding. This induced signal is affected by changes in the permeability of the core and appears as an amplitude variation in the output of the sensing coil. The signal is then demodulated with a phase-sensitive detector and filtered to retrieve the magnetic field value. After being converted to a standardized digital format, the data can be output to numerous remote devices, including steering compasses, bearing compasses, emergency steering stations, and autopilots.

Since the influence of a ship's inherent magnetism is inversely proportional to the square of the distance to the compass, it is logical that if the compass could be located at some distance from the ship, the influence of the ship's magnetic field could be greatly reduced. One advantage of the flux gate compass is that the sensor can be located remotely from the readout device, allowing it to be placed at a position as far as possible from the hull and its contents, such as high up on a mast, the ideal place for most vessels.

A further advantage is that the digital signal can be processed mathematically, and algorithms written which can correct for observed deviation once the deviation table has been determined. Further, the "table," in digital format,

can be found by merely steering the vessel in a full circle. Algorithms then determine and apply corrections that effectively flatten the usual sine wave pattern of deviation. The theoretical result is zero observed compass deviation.

Should there be an index error (which has the effect of skewing the entire sine wave below or above the zero degree axis of the deviation curve) this can be corrected with an index correction applied to all the readings. This problem is largely confined to asymmetric installations such as aircraft carriers. Similarly, a correction for variation can be applied, and with GPS input (so the system knows where it is with respect to the isogonic map) the variation correction can be applied automatically, thus rendering the output in true degrees, corrected for both deviation and variation.

It is important to remember that a flux gate compass is still a magnetic compass, and that it will be influenced by large changes to the ship's magnetic field. Compensation should be accomplished after every such change. Fortunately, as noted, compensation involves merely steering the vessel in a circle in accordance with the manufacturer's recommendations.

Flux-gate compasses from different manufacturers share some similar operational modes. Most of them will have the following:

SET COURSE MODE: A course can be set and "remembered" by the system, which then provides the helmsman a graphic steering aid, enabling him to see if the ship's head is right or left of the set course, as if on a digital "highway." Normal compass operation continues in the background.

DISPLAY RESPONSE DAMPING: In this mode, a switch is used to change the rate of damping and update of the display in response to changes in sea condition and vessel speed.

AUTO-COMPENSATION: This mode is used to determine the deviation curve for the vessel as it steams in a complete circle. The system will then automatically compute correction factors to apply around the entire compass, resulting in zero deviation at any given heading. This should be done after every significant change in the magnetic signature of the ship, and within 24 hours of entering restricted waters.

CONTINUOUS AUTO-COMPENSATION: This mode, which should normally be turned OFF in restricted waters and ON at sea, runs the compensation algorithm each time the ship completes a 360 degree turn in two minutes. A warning will flash on the display in the OFF mode.

PRE-SET VARIATION: In effect an index correction, pre-set variation allows the application of magnetic variation to the heading, resulting in a true output (assuming the unit has been properly compensated and aligned). Since variation changes according to one's

location on the Earth, it must be changed periodically to agree with the charted variation unless GPS input is provided. The GPS position input is used in an algorithm which computes the variation for the area and automatically corrects the readout.

U.S. Naval policy approves the use of flux gate compasses and the lay-up, but not the removal of the traditional binnacle mounted compass, which should be clearly marked as "Out of Commission" once an approved flux gate compass has been properly installed and tested.

824. Optical Gyroscopes

Optical gyroscope use can be classified under two major types: ring laser gyroscope (RLG) and fiber optic gyroscope (FOG). Both of these sensors make use of French Physicist Georges Sagnac's observation of rotation relative to inertial space thus bearing the name, Sagnac Effect. This principle states that if two beams of light are sent in opposite directions around a "ring" or polyhedron and steered so as to meet and combine, a standing wave will form around the ring. If the wave is observed from any point, and that point is then moved along the perimeter of the ring, the wave form will change in direct relationship to the direction and velocity of movement. While Sagnac's work was in pursuit of identifying the "ether" that was postulated in the late 19th century as the medium that supported the propagation of light waves, the effect that he predicted and measured was found to be rooted in general relativity. Sagnac is given significant credit, because he was the first person to report the experimental observation for a polygonal interferometer mounted on a turn-table. The practical realization of a Sagnac interferometer as a rotation sensor came only after the invention of the laser and other optical components. The Sagnac interferometer can be implemented in a resonant cavity as in the case of the RLG or in a non-resonant interferometer configuration of which the commercially available FOG is an example. While it is true that a FOG can be configured as a resonant cavity, this type of device has not yet achieved commercial success and will not be described herein.

825. The Ring Laser Gyrocompass

The ring laser had its beginnings in England, where in the 1890's two scientists, Joseph Larmor and Sir Oliver Lodge (also one of the pioneers of radio), debated the possibility of measuring rotation by a ring interferometer. Following Sagnac's 1913 observation. It wasn't until 1963 that D. T. M. Davis Jr. and W. Macek of Sperry-Rand Corporation tested and refined the concept into a useful research device. Initially, mirrors were used to direct light around a square or rectangular pattern. But such mirrors must be made and adjusted to exceptionally close tolerances to allow useful output, and must operate in a vacuum for best effect. Multilayer dielectric mirrors with a

reflectivity of 99.9999 percent were developed. The invention of laser light sources and fiber-optics has enabled the production of small, light, and dependable ring laser gyros. Mirror-based devices continue to be used in physics research.

The ring laser gyrocompass (RLG) operates by measuring laser-generated light waves traveling around a fiber-optic ring. A beam splitter divides a beam of light into two counter-rotating waves, which then travel around the fiber-optic ring in opposite directions. The beams are then recombined and sent to an output detector. In the absence of rotation, the path lengths will be the same and the beams will recombine in phase. If the device has rotated, there will be a difference in the length of the paths of the two beams, resulting in a detectable phase difference in the combined signal. The signal will vary in amplitude depending on the amount of the phase shift. The amplitude is thus a measurement of the phase shift, and consequently, the rotation rate. This signal is processed into a digital readout in degrees. This readout, being digital, can then be sent to a variety of devices which need heading information, such as helm, autopilot, and electronic chart systems.

A single ring laser gyroscope can be used to provide a one-dimensional rotational reference, exactly what a compass needs. The usefulness of ring laser gyrocompasses is clear in that they share many of the same characteristics of flux gate compasses. They are compact, light, inexpensive, accurate, dependable, and robust. The ring laser device is also unaffected by magnetic influences that would certainly impact the traditional compass, and even such that might adversely affect a remotely mounted flux gate compass.

Ring laser gyroscopes can also serve as the stable elements in an inertial guidance system, using three gyros to represent the three degrees of freedom, thus providing both directional and position information. The principle of operation is the same as for mechanical inertial navigation devices, in that a single gyro can measure any rotation about its own axis. This implies that its orientation in space about its own axis will be known at all times. Three gyros arranged along three axes each at 90 degrees to the others can measure accelerations in three dimensional space, and thus track movement over time.

Inertial navigation systems based on ring lasers have been used in aircraft for a number of years, and are becoming increasingly common in maritime applications. Uses include navigation, radar and fire control systems, precise weapons stabilization, and stabilization of directional sensors such as satellite antennas.

826. The Fiber Optic Gyro

A non-resonant Sagnac interferometer is used as the basis of what is referred to as the interferometric fiber optic gyro (IFOG) often shortened to simply FOG. Resonant fiber optic gyros have been developed but at this time have

not become commercially practical.

The development of the FOG required its own enabling technology, namely low loss, single mode optical fibers that became available in the mid-1970s. Vali and Shorthill first proposed the fiber optic gyro in 1975. The FOG is composed of a light source, a coupler, a fiber coil and a detector. Light is launched from the source and coupled through a fiber optic coil in both the clockwise and counter-clockwise directions. Based on the Sagnac effect, the optical path seen by the two beams interfere and the intensity detected is a function of the phase difference and hence the angular rate of the gyro.

The interferometric architecture of the FOG has a poor sensitivity at low rates as due to cosine nature of the phase difference and near zero phase at the peak of the cosine function. To achieve better sensitivity, it is necessary to modulate the light which is accomplished in modern FOG configurations through the use of an electro-optic phase modulator. Light passing through the modulator is phase shifted in proportion to the applied voltage. Differential phase shifts between the clockwise and counter-clockwise beams are sustained for only one transit time of the light through the coil and thus the modulation must be applied every transit time.

Phase modulation of the light improves the sensitivity at low angular rates. However, the high rate non-linearity, light intensity variation, photo-detector sensitivity, preamp gain and background intensity all affect the open loop output of the FOG. For this reason, it is important for higher accuracy and greater dynamic range to operate the FOG in a closed loop fashion. The same device that accomplished the phase shifting of the light is typically used to close the loop in the FOG. Because the angular rate sensed by the FOG appears as an interferometer phase shift, it may be nulled out by applying a phase rebalance in addition to the phase shift with the modulator. A complication arises due to the fact that the modulator can produce a differential phase shift between clockwise and counter-clockwise light beams only during the transit time of the light through the fiber coil and a given angular rate produces a persistent phase shift between the light beams. To achieve phase nulling, it is necessary to increase the phase applied at every transit time. A periodic reset is required when the maximum voltage that is supplied to the modulator is reached. The magnitude of this reset must be exactly $2(\pi)$ to avoid introducing a gyro error.

The sensitivity of the FOG is theoretically limited by the photon shot noise which emerges from the statistical distribution of energy of the photon impinging on the photo detector. While the Sagnac sensitivity increases with the length of the fiber, the photon energy decreases with fiber length due to attenuation of the light as it travels through the fiber. Thus a tradeoff must be done when choosing the size of the FOG for a given application. Errors in the FOG output arise through a number of sources. Rayleigh backscattering is the dominant error source in the FOG.

This comes about when backscatter of one beam interferes with the other light beam. Low coherence light sources are used to reduce this effect. Two popular light sources for FOGs are the superluminescent diode (SLD) and the broadband fiber source (BFS). The change in the index of refraction of the fiber as a function of the intensity of the light induces an error through the optical Kerr effect. This effect is also reduced through the use of low coherence light sources. The thermal gradient effect due to uneven heating of the fiber coil is typically the major challenge to achieving required performance in the FOG. The light beam will experience propagation delays due to temperature differences along the length of the fiber. These propagation delays are not the same for the two counter propagating beams which results in a gyro error. Sophisticated coil winding designs, such as quadrupole or octopole can help to minimize this effect. Finally, birefringence effects, from the fiber, can result in errors; good control of the light polarization if required.

The FOG has gained a wide acceptance and is found in a wide variety of applications from undersea to outer space. The performance of the FOG as a gyro is dependent primarily on the diameter of the fiber coil and the length of the fiber. Thus the size of the FOG can vary significantly from coil diameters of approximately an inch with less than 100 meters of fiber to diameters of several inches containing multiple kilometers of fiber depending on the application and performance requirement. The FOG has been shown to have better reliability than that of the RLG and further eliminates the need for any high voltages that are required to initiate and maintain the plasma in the RLG. For these reasons, the marketplace is moving from RLG to FOG. Also, while there are only a few manufacturers of RLG left around the globe, and it is estimated that there may be more than a dozen manufacturers of FOG based systems worldwide.

827. The Hemispherical Resonator Gyro

The Hemispherical Resonator Gyro (HRG) belongs to a class of gyros referred to as Coriolis Vibratory Gyros (CVG). The physics of the HRG is based on the forces arising from the Coriolis Effect which describes the motion of a body undergoing uniform motion in a rotating frame of reference. The HRG was conceived in 1890 when physicist G.H. Bryan struck a wineglass, making an interesting discovery of how the tone from a glass behaved when it was rotated about its stem. To understand the operation of an HRG, consider a thin hemispherical shell, although other suitable configurations can also be used, such as cylindrical, whereas the rim of the shell can be made to vibrate by applying appropriate force and technique. The lowest fundamental mode is characterized by four nodes and four antinodes of vibration. The rim of the shell will then have a radial velocity component at the antinodes and

a tangential velocity component at the nodes.

When the shell is subject to an angular rate about its sensitive axis, which is perpendicular to the plane of the standing wave pattern, Coriolis forces are generated. These forces are proportional to the applied angular rate and are orthogonal to both the applied rate vector and the shell's velocity vectors. The result of these forces is standing wave whose nodes and antinodes are now shifted with respect to the original pattern. The superposition of the original wave and the new orthogonal wave result in a phenomenon in which the resultant wave rotates relative to its own casing and to inertial space through an angle that is proportional to the angular rotation of the gyro case. The resultant pattern precesses in the opposite sense. The angular gain factor is a function of the geometrical design and provides a very stable gyro scale factor. The electrical sensing of pattern is typically accomplished through capacitive elements that are implemented between the shell and another element separated from the shell by a suitable gap.

The HRG is attractive as a result of the very low noise figure, one or two order of magnitude better than what can be achieved with either an RLG or FOB of comparable design. Furthermore, due to the simplistic nature of the sensing element, the HRG has realized extraordinary reliability with tens of millions of failure-free operations exhibited in space applications. The challenges with the HRG are also related to the simplicity of the sensing element since that results in complexity of the electronics required for operation, HRG electronic functions are broadly grouped into the following categories:

1. Reference phase generation and frequency control
2. Amplitude control
3. Pattern angle readout
4. Quadrature suppression
5. Force-to-rebalance mode of operation
6. Whole angle mode of operation

In the force-to-rebalance mode of operation, the nodes and antinodes are capacitively held in place. The capacitive force required to do this is a measure of the angular rate experienced by the HRG. In this mode of operation, the bias errors can be minimized; however, the gyro scale factor is a function of the electronics and temporal trends in scale factor are observed as the electronics age. The force-to-rebalance mode is limited by the available capacitive forcing. This limits the angular rate range typically to less than 100 deg/sec for practical devices. In the whole angle mode of operation, the pattern is allowed to precess and so the angular rate range is limited only by the processing electronics. As already mentioned, the geometric scale factor is very stable and hence scale factor performance of the HRG is excellent in the whole angle mode; however, the bias performance tends not be as good as in the force-to-rebalance mode.

CORRECTING AND UNCORRECTING THE COMPASS

828. Ship’s Heading

Ship’s heading is the angle, expressed in degrees clockwise from north, of the ship’s fore-and-aft line with respect to the true meridian or the magnetic meridian. When this angle is referred to the true meridian, it is called a **true heading**. When this angle is referred to the magnetic meridian, it is called a **magnetic heading**. Heading, as indicated on a particular compass, is termed the ship’s compass heading by that compass. It is essential to specify every heading as true (T), magnetic (M), or compass. Two abbreviations simplify recording of compass directions. The abbreviation PGC refers to “per gyro compass,” and PSC refers to “per steering compass.” The steering compass is the one being used by the helmsman or autopilot, regardless of type.

829. Variation and Deviation

Variation is the angular measure between the magnetic meridian and the true meridian at a given location. If the northerly part of the magnetic meridian lies to the right of the true meridian, the variation is easterly. Conversely, if this part is to the left of the true meridian, the variation is westerly. The local variation and its small **annual change** are noted on the compass rose of all navigational charts. Thus the true and magnetic headings of a ship differ by the local variation.

As previously explained, a ship’s magnetic influence will generally cause the compass needle to deflect from the magnetic meridian. This angle of deflection is called **deviation**. If the north end of the needle points east of the magnetic meridian, the deviation is easterly; if it points west of the magnetic meridian, the deviation is westerly.

830. Heading Relationships

A summary of heading relationships follows:

1. **Deviation** is the difference between the compass heading and the magnetic heading.

2. **Variation** is the difference between the magnetic heading and the true heading.
3. The algebraic sum of deviation and variation is the **compass error**.

The following simple rules will assist in correcting and uncorrecting the compass:

1. Compass least, error east; compass best, error west.
2. When correcting, add easterly errors, subtract westerly errors (Remember: “Correcting Add East”).
3. When uncorrecting, subtract easterly errors, add westerly errors.

Some typical correction operations follow:

<u>Compass</u>	<u>Deviation</u>	<u>Magnetic</u>	<u>Variation</u>	<u>True</u>
		-> +E, -W		
358°	5°E	003°	6°E	009°
120°	1°W	119°	3°E	122°
180°	6°E	186°	8°W	178°
240°	5°W	235°	7°W	228°
		+W, -E <-		

Figure 830. Examples of compass correcting.

Use the memory aid “Can Dead Men Vote Twice, At Elections” to remember the conversion process (Compass, Deviation, Magnetic, Variation, True; Add East). When converting compass heading to true heading, add easterly deviations and variations and subtract westerly deviations and variations. “Truly Valiant Marines Don’t Cry at Weddings” is another phrase used to remember compass correction where Westerly error is added.

The same rules apply to correcting gyrocompass errors, although gyro errors always apply in the same direction. That is, they are E or W all around the compass.

Complete familiarity with the correcting of compasses is essential for navigation by magnetic or gyro compass. Professional navigators who deals with them continually can do them in their heads quickly and accurately.

CHAPTER 9

DEAD RECKONING

DEFINITION AND PURPOSE

900. Definition and Use

Dead reckoning (DR) is a method for determining the estimated position of a vessel by advancing from a known fix of position along the vessel's ordered course and speed. This can be used to determine where a vessel currently is or where it will be. This is an approximate position; it does not allow for the many errors that can cause a vessel to veer off course such as helmsmen error, compass error, or current and wind.

Dead reckoning helps in predicting landfall, determining distances to objects, predicting arrival times, and evaluating the accuracy of electronic positioning information. It also aids in predicting which celestial bodies will be available for future observation. However, its most important use is in projecting the ship's position in the immediate future and avoiding hazards to navigation.

The navigator should carefully tend his or her DR plot, updating it when required and using it to evaluate external forces acting on his or her ship. Navigators can compare the

dead reckoning position to a known fix to determine other forces acting on the vessel, such as wind and current. They can then use all this information to create a more accurate DR plot and stay on course by correcting for the known errors and their effects.

The use of DR when an Electronic Chart Display and Information System (ECDIS) is the primary plotting method can vary with the type of system. An ECDIS can display the ship's heading projected out to show future positions as a function of time, display waypoint information, and/or show progress toward each waypoint in turn.

Presently, marine navigation is in a time of transition with some ships completely paperless and others using a combination of electronic and paper charting. If paper charts are the back up to ECDIS (instead of an additional type-approved ECDIS) it would be prudent to DR as a cross-check to the GPS/GNSS derived position on the EDCIS. Plotting positions on the paper chart should be done at appropriate intervals. The following procedures apply to DR plotting on the traditional paper chart.

CONSTRUCTING THE DEAD RECKONING PLOT

The DR plot should be maintained directly on the chart in use. DR at least two fix intervals ahead while piloting. When transiting on the open ocean, maintain the DR at least four hours ahead of the last fix position. Maintaining the DR plot directly on the chart allows the navigator to evaluate a vessel's future position in relation to charted navigation hazards. It also allows the conning officer and captain to plan course and speed changes required to meet any operational commitments.

This section will discuss how to construct the DR plot.

901. Measuring Courses and Distances

To measure courses, use the chart's compass rose nearest to the chart area currently in use. Transfer course lines to and from the compass rose using parallel rulers, rolling rulers, or triangles. If using a parallel motion plotter (PMP), simply set the plotter at the desired course and plot that course directly on the chart. Transparent plastic navigation plotters that align with the latitude/longitude grid may also be used.

The navigator can measure direction at any convenient

place on a Mercator chart. All the meridians are parallel to each other and a line making an angle with any one makes the same angle with all others. When measuring direction on a conformal chart having nonparallel meridians, use the meridian closest to the area of the chart in use. A common nonconformal projection used is the gnomonic; a gnomonic chart usually contains instructions for measuring direction.

Compass roses may give both true and magnetic directions. True directions are on the outside of the rose; magnetic directions are on the inside. For most purposes, use true directions.

Measure distances using the chart's latitude scale. Although not technically true, assuming that one minute of latitude equals one nautical mile introduces no significant error. The latitude scale on a Mercator chart expands as the latitude increases, therefore one must measure distances on the latitude scale closest to the area of interest when working with small-scale charts. On large-scale charts, such as harbor charts, one can use either the latitude scale or the distance scale provided. To measure long distances on small-scale charts, break the distance into a number of segments and

measure each segment at its mid-latitude.

902. Plotting and Labeling the Course Line and Positions

Draw a new **course line** whenever restarting the DR. To draw a DR, extend the course line from a fix in the direction of the ordered course. Above the course line place a capital C followed by the ordered course in degrees true. Below the course line, place a capital S followed by the speed in knots. Label all course lines and fixes after plotting them because a conning officer or navigator can easily misinterpret an unlabeled line or position.

Enclose a fix from two or more Lines of Position (LOP) by a small circle and label it with the time to the nearest minute, written horizontally. Mark a DR position with a semicircle and the time, written diagonally. Mark an **estimated position (EP)** by a small square and the time, written horizontally. Determining an EP is covered later in this chapter.

Express the time using four digits without punctuation, using either zone time or Greenwich Mean Time (GMT),

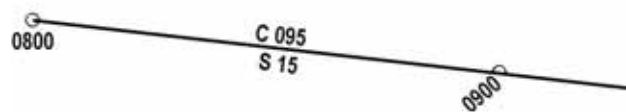

Figure 902. A course line with labels.

Figure 902 illustrates this process. The navigator plots and labels the 0800 fix. The conning officer orders a course of 095°T and a speed of 15 knots. The navigator extends the course line from the 0800 fix in a direction of 095°T . S/He calculates that in one hour at 15 knots he will travel 15 nautical miles. S/He measures 15 nautical miles from the 0800 fix position along the course line and marks that point on the course line with a semicircle. S/He labels this DR with the time. Note that, by convention, he labels the fix time horizontally and the DR time diagonally.

THE FOUR RULES OF DEAD RECKONING

903. Plotting the DR

To effectively maintain the vessel's DR position, the navigator must follow the 4 rules of DR.

Plot a fix:

1. At least every hour on the hour.
2. After every change of course or speed.
3. After every fix or running fix.
4. After plotting a single line of position.

Figure 903 illustrates applying these rules. Clearing the harbor at 0900, the navigator obtains a last visual fix. This is called **taking departure**, and the position determined is called the **departure**. At the 0900 departure, the conning officer orders a course of 090°T and a speed of 10 knots. The navigator lays out the 090°T course line from the departure.

At 1000, the navigator plots a DR position according to the rule requiring plotting a DR position at least every hour on the hour. At 1030, the conning officer orders a course change to 060°T . The navigator plots the 1030 DR position in accordance with the rule requiring plotting a DR position at every course and speed change. Note that the course line changes at 1030 to 060°T to conform to the new course. At 1100, the conning officer changes course back to 090°T . The navigator plots an 1100 DR due to the course change. Note that, regardless of the course change, an 1100 DR would have been required because of the "every hour on the hour" rule.

At 1200, the conning officer changes course to 180°T

and speed to 5 knots. The navigator plots the 1200 DR. At 1300, the navigator obtains a fix. Note that the fix position is offset to the east from the DR position. The navigator determines set and drift from this offset and applies this set and drift to any DR position from 1300 until the next fix to determine an estimated position. S/He also resets the DR to the fix; that is, s/he draws the 180°T course line from the 1300 fix, not the 1300 DR.

904. Resetting the DR

Reset the DR plot to each fix or running fix in turn. In addition, consider resetting the DR to an inertial estimated position, if an inertial system is installed.

If a navigator has not taken a fix for an extended period of time, the DR plot, not having been reset to a fix, will accumulate time-dependent errors. Over time that error may become so significant that the DR will no longer show the ship's position with acceptable accuracy. If the vessel is equipped with an inertial navigator, the navigator should consider resetting the DR to the inertial estimated position. Some factors to consider when determining whether to reset the DR are:

(1) Time since the last fix and availability of fix information. If it has been a short time since the last fix and fix information may soon become available, it may be advisable to wait for the next fix to reset the DR.

(2) Dynamics of the navigation situation. If, for example, a submerged submarine is operating in the Gulf Stream, fix information is available but operational considerations may preclude the submarine from going to

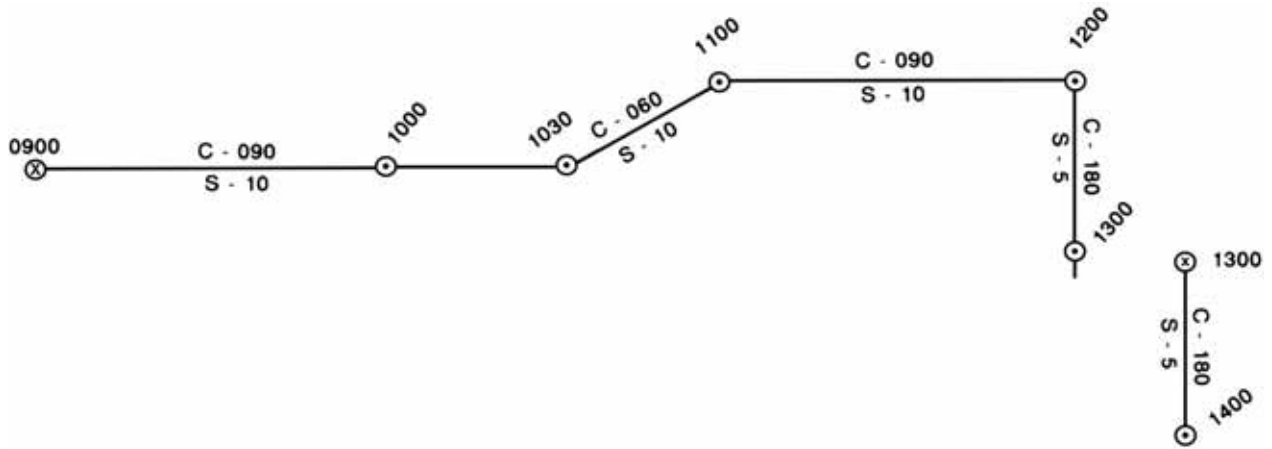

Figure 903. A typical dead reckoning plot.

periscope depth to obtain a fix. Similarly, a surface ship with an inertial navigator may be in a dynamic current and suffer a temporary loss of electronic fix equipment. In either case, the fix information will be available shortly but the dynamics of the situation call for a more accurate assessment of the vessel's position. Plotting an inertial EP and resetting the DR to that EP may provide the navigator with a more accurate assessment of the navigation situation.

(3) Reliability and accuracy of the fix source. If a submarine is operating under the ice, for example, only the inertial EP fixes may be available for weeks at a time. Given a high prior correlation between the inertial EP and highly accurate fix systems such as GPS, and the continued proper operation of the inertial navigator, the navigator may decide to reset the DR to the inertial EP.

DEAD RECKONING AND SHIP SAFETY

Properly maintaining a DR plot is important for ship safety. The DR allows the navigator to examine a future position in relation to a planned track. It allows him to anticipate charted hazards and plan appropriate action to avoid them. Recall that the DR position is only approximate. Using a concept called fix expansion compensates for the DR's inaccuracy and allows the navigator to use the DR more effectively to anticipate and avoid danger.

905. Fix Expansion

Circumstances may arise where a ship steams in the open ocean for extended periods without a fix. This can result from a combination of factors ranging from the inability to obtain celestial fixes to malfunctioning electronic navigation systems. Infrequent fixes are particularly common on submarines. Whatever the reason, in some instances a navigator may find himself in the position of having to steam many hours on DR alone.

Navigators must take precautions to ensure that all hazards to navigation along their path are accounted for by the approximate nature of a DR position. One method which can be used is fix expansion.

Fix expansion takes into account possible errors in the DR calculation caused by factors which tend to affect the vessel's actual course and speed over the ground. The

navigator considers all such factors and develops an expanding "error circle" around the DR plot. One of the basic assumptions of fix expansion is that the various individual effects of current, leeway, and steering error combine to cause a cumulative error which increases over time, hence, the concept of expansion. While the errors may in fact cancel each other out, the worst case is that they will all be additive, and this is what the navigator must anticipate.

Errors considered in the calculation of fix expansion encompass all errors that can lead to DR inaccuracy. Some of the most important factors are current and wind, compass or gyro error, and steering error. Any method which attempts to determine an error circle must take these factors into account. The navigator can use the magnitude of set and drift calculated from his or her DR plot. See Section 907. The current's estimated magnitude can be obtained from pilot charts or weather reports. Wind speed can be gathered from weather instruments. Compass error can be found by comparison with an accurate standard or by obtaining an azimuth of the Sun. The navigator determines the effect each of these errors has on his or her course and speed over ground, and applies that error to the fix expansion calculation.

As noted previously, error is a function of time; it grows as the ship proceeds along the track without obtaining a fix. Therefore, the navigator must incorporate

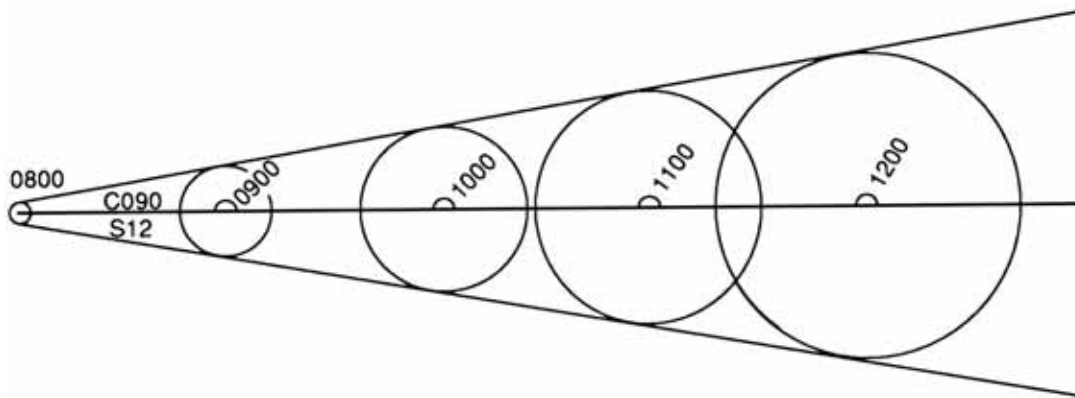

Figure 905. Fix expansion. All possible positions of the ship lie between the lines tangent to the expanding circles. Examine this area for dangers.

the calculated errors into an **error circle** whose radius grows with time. For example, assume the navigator calculates that all the various sources of error can create a cumulative position error of no more than 2 nm. Then his or her fix expansion error circle would grow at that rate; it would be 2 nm after the first hour, 4 nm after the second, and so on.

At what value should the navigator start this error circle? Recall that a DR is laid out from every fix. All fix sources have a finite absolute accuracy, and the initial error circle should reflect that accuracy. Assume, for example, that a satellite navigation system has an accuracy of 0.5 nm. Then the initial error circle around that fix should be set at 0.5 nm.

First, enclose the fix position in a circle, the radius of which is equal to the accuracy of the system used to obtain the fix. Next, lay out the ordered course and speed from the fix position. Then apply the fix expansion circle to the hourly DRs, increasing the radius of the circle by the error factor each time. In the example given above, the DR after one hour would be enclosed by a circle of radius 2.5 nm (that is, 2 nm

of cumulative position error + 0.5 nm of satellite navigation error), after two hours 4.5 nm, and so on. Having encircled the four hour DR positions with the error circles, the navigator then draws two lines originating tangent to the original error circle and simultaneously tangent to the other error circles. The navigator then closely examines the area between the two tangent lines for hazards to navigation. This technique is illustrated in Figure 905.

The fix expansion encompasses the total area in which the vessel could be located (as long as all sources of error are considered). If any hazards are indicated within the cone, the navigator should be especially alert for those dangers. If, for example, the fix expansion indicates that the vessel may be standing into shoal water, continuously monitor the fathometer. Similarly, if the fix expansion indicates that the vessel might be approaching a charted obstruction, post extra lookouts.

The fix expansion may grow at such a rate that it becomes unwieldy. Obviously, if the fix expansion grows to cover too large an area, it has lost its usefulness as a tool for the navigator, and he or she should obtain a new fix by any available means.

DETERMINING AN ESTIMATED POSITION

An estimated position (EP) is a DR position corrected for the effects of leeway, steering error, and current. This section will briefly discuss the factors that cause the DR position to diverge from the vessel's actual position. It will then discuss calculating set and drift and applying these values to the DR to obtain an estimated position. It will also discuss determining the estimated course and speed made good.

906. Factors Affecting DR Position Accuracy

Tidal current is the periodic horizontal movement of the sea caused by the tide-affecting gravitational forces of the moon and sun. **Current** is the horizontal movement of

the sea caused by meteorological, oceanographic, or topographical effects. From whatever its source, the horizontal motion of the sea is an important dynamic force acting on a vessel.

Set refers to the current's direction, and **drift** refers to the current's speed. **Leeway** is the leeward motion of a vessel due to that component of the wind vector perpendicular to the vessel's track. Leeway and current combine to produce the most pronounced natural dynamic effects on a transiting vessel. Leeway especially affects sailing vessels and high-sided vessels.

In addition to these natural forces, relatively small helmsman and steering compass errors may combine to cause additional error in the DR.

907. Calculating Set and Drift and Plotting an Estimated Position

It is difficult to quantify the errors discussed above individually. However, the navigator can easily quantify their cumulative effect by comparing simultaneous fix and DR positions. If there are no dynamic forces acting on the vessel and no steering error, the DR position and the fix position will coincide. However, this seldom occurs; the fix is normally offset from the DR by the vector sum of all the errors.

Note again that this methodology provides no means to determine the magnitude of the individual errors. It simply provides the navigator with a measurable representation of their combined effect.

When the navigator measures this combined effect, s/he often refers to it as the “set and drift.” Recall from above that these terms technically were restricted to describing current effects. However, even though the fix-to-DR offset is caused by effects in addition to the current, this text will follow the convention of referring to the offset as the set and drift.

The set is the direction from the DR to the fix. The drift is the distance in miles between the DR and the fix divided by the number of hours since the DR was last reset. This is true regardless of the number of changes of course or speed since the last fix. The prudent navigator calculates set and drift at every fix.

To calculate an EP, draw a vector from the DR position in the direction of the set, with the length equal to the product of the drift and the number of hours since the last reset. See Figure 907. From the 0900 DR position the navigator draws a set and drift vector. The end of that vector marks the 0900 EP. Note that the EP is enclosed in a square and labeled horizontally with the time. Plot and evaluate an EP with every DR position.

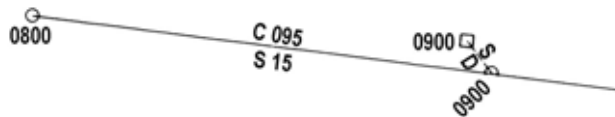

Figure 907. Determining an estimated position.

908. Estimated Course and Speed Made Good

The direction of a straight line from the last fix to the EP is the **estimated track made good**. The length of this line divided by the time between the fix and the EP is the **estimated speed made good**.

Solve for the estimated track and speed by using a vector diagram. See the example problems below and refer to Figure 908a.

Example 1: A ship on course 080° , speed 10 knots, is steaming through a current having an estimated set of 140° and drift of 2 knots.

Required: Estimated track and speed made good.

Solution: See Figure 908a. From A, any convenient point, draw AB, the course and speed of the ship, in direction 080° , for a distance of 10 miles.

From B draw BC, the set and drift of the current, in direction 140° , for a distance of 2 miles.

The direction and length of AC are the estimated track and speed made good.

Answers: Estimated track made good 089° , estimated speed made good 11.2 knots.

To find the course to steer at a given speed to make good a desired course, plot the current vector from the origin, A, instead of from B. See Figure 908b.

Example 2: The captain desires to make good a course of 095° through a current having a set of 170° and a drift of 2.5 knots, using a speed of 12 knots.

Required: The course to steer and the speed made good.

Solution: See Figure 908b. From A, any convenient point, draw line AB extending in the direction of the course to be made good, 095° .

From A draw AC, the set and drift of the current.

Using C as a center, swing an arc of radius CD, the speed through the water (12 knots), intersecting line AB at D.

Measure the direction of line CD, 083.5° . This is the course to steer.

Measure the length AD, 12.4 knots. This is the speed made good.

Answers: Course to steer 083.5° , speed made good 12.4 knots.

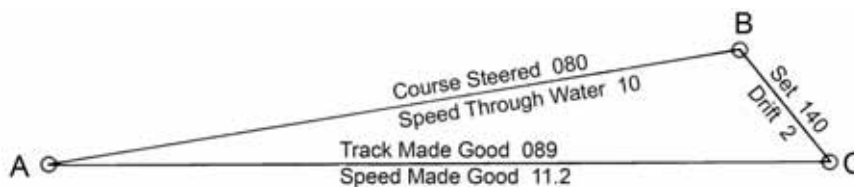

Figure 908a. Finding track and speed made good through a current.

To find the course to steer and the speed to use to make good a desired course and speed, proceed as follows:

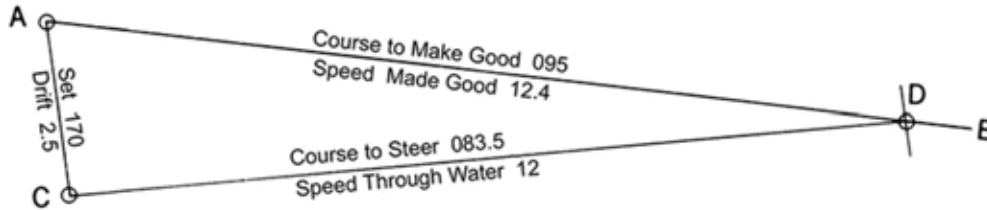

Figure 908b. Finding the course to steer at a given speed to make good a given course through a current.

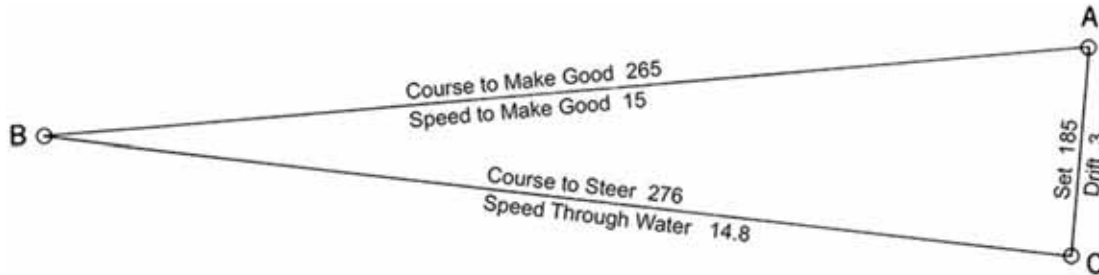

Figure 908c. Finding course to steer and speed to use to make good a given course and speed through the current.

See Figure 908c.

Example 3: The captain desires to make good a course of 265° and a speed of 15 knots through a current having a set of 185° and a drift of 3 knots.

Required: The course to steer and the speed to use.

Solution: See Figure 908c. From A, any convenient point, draw AB in the direction of the course to be made good, 265° and for length equal to the speed to be made

good, 15 knots.

From A draw AC, the set and drift of the current.

Draw a straight line from C to B. The direction of this line, 276° , is the required course to steer; and the length, 14.8 knots, is the required speed.

Answers: Course to steer 276° , speed to use 14.8 knots.

CHAPTER 10

PILOTING

DEFINITION AND PURPOSE

1000. Introduction

Piloting involves navigating a vessel in restricted waters and fixing its position as precisely as possible at frequent intervals. Proper preparation and attention to detail are more important here than in other phases of navigation. This chapter will discuss a piloting methodology designed to ensure that procedures are carried out safely and efficiently. These procedures will vary from vessel to vessel according to the skills and composition of the piloting team. It is the responsibility of the navigator to choose the procedures applicable to his or her own situation, to train the piloting team in their execution, and to ensure that duties are carried out properly.

These procedures are written primarily from the perspective of the military navigator, with some notes included where civilian procedures might differ. This set of procedures is designed to minimize the chance of error and maximize safety of the ship.

The military navigation team will nearly always consist of several more people than are available to the civilian navigator. Therefore, the civilian navigator must streamline these procedures, eliminating certain steps, doing only what is essential to keep his or her ship in safe water.

The navigation of civilian vessels will therefore proceed differently than for military vessels. For example, while the military navigator might have bearing takers stationed at the

gyro repeaters on the bridge wings for taking simultaneous bearings, the civilian navigator must often take and plot them himself. While the military navigator will have a bearing book and someone to record entries for each fix, the civilian navigator will simply plot the bearings on the chart as they are taken and not record them at all.

ECDIS is a good instrument to monitor the vessels track, however, the prudent navigator should continue to actively plot positions. If a pilot is aboard, as is often the case in the most restricted of waters, his or her judgment can generally be relied upon explicitly, further easing the workload. But should the ECDIS fail, the navigator will have to rely on his or her skill in the manual and time-tested procedures discussed in this chapter.

While an ECDIS is the legal equivalent of a paper chart and can be used as the primary plot, an **ECS**, (non-ECDIS compliant electronic chart system) cannot be so used. An ECS may be considered as an additional resource used to ensure safe navigation, but cannot be relied upon for performing all the routine tasks associated with piloting. The individual navigator, with knowledge of his or her vessel, his or her crew, and the capabilities they possess, must make a professional judgment as to how the ECS can support his or her efforts to keep his or her ship in safe water. The navigator should always remember that reliance on any single navigation system courts disaster. An ECS does not relieve the navigator of maintaining a proper and legal plot on a paper chart.

PREPARATION

1001. Plot Setup

The navigator's job begins well before getting underway. Advance preparation is necessary to ensure a safe and efficient voyage. The following steps are representative:

Ensure the plotting station(s) have the following instruments:

- **Dividers:** Dividers are used to measure distances between points on the chart.
- **Compasses:** Compasses are used to plot range arcs for radar LOP's. **Beam compasses** are used when the range arc exceeds the spread of a conventional compass. Both types should be available at the plotting stations.
- **Plotters:** Several types of plotters are available. The

preferred device for large vessels is the parallel motion plotter (PMP) used in conjunction with a drafting table. Otherwise, use a transparent protractor plotter, or triangles, parallel rulers or rolling rulers in conjunction with the chart's compass rose. Finally, the plotter can use a one arm protractor. The plotter should use the device with which he or she can work the most quickly and accurately.

- **Sharpened Pencils and Erasers:** Ensure an adequate supply of pencils is available.
- **Nautical Slide Rule:** For solving time, speed, and distance problems.
- **Tide and Current Graphs:** Post the tide and current graphs near the primary plot for easy reference during the transit. Give a copy of the graphs to the conning of-

ficer and the captain.

Once the navigator verifies the above equipment is in place, he or she tapes down the charts on the chart table. If more than one chart is required for the transit, tape the charts in a stack such that the plotter works from the top to the bottom of the stack. This minimizes the time required to shift the chart during the transit. If the plotter is using a PMP, align the arm of the PMP with any meridian of longitude on the chart. While holding the PMP arm stationary, adjust the PMP to read 000.0°T. This procedure calibrates the PMP to the chart in use. Perform this alignment every time the piloting team shifts charts.

Be careful not to fold under any important information when folding the chart on the chart table. Ensure the chart's distance scale, the entire track, and all important warning information are visible.

Energize and test all electronic navigation equipment, if not already in operation. This includes the radar and the GPS receiver. Energize and test the fathometer. Ensure the entire electronic navigation suite is operating properly prior to entering restricted waters.

1002. Preparing Charts and Publications

- **Assemble or Download Required Publications.** These publications should include *Coast Pilots*, *Sailing Directions*, *USCG Light Lists*, *NGA Lists of Lights*, *Tide Tables*, *Tidal Current Tables*, *Notice to Mariners*, and *Local Notice to Mariners*. Often, for military vessels, a port will be under the operational direction of a particular squadron; obtain that squadron's port Operation Order. Civilian vessels should obtain the port's harbor regulations. These publications will cover local regulations such as speed limits and bridge-to-bridge radio frequency monitoring requirements. Assemble and review the Broadcast Notice to Mariners file.
- **Select and Correct Charts.** Choose the largest scale chart available for the harbor approach or departure. Often, the harbor approach will be too long to be represented on only one chart. For example, three charts are required to cover the waters from the Naval Station in Norfolk to the entrance of the Chesapeake Bay. Therefore, obtain all the charts required to cover the entire passage. Using the *Notice to Mariners*, verify that these charts have been corrected through the latest *Notice to Mariners*. Check the *Local Notice to Mariners* and the Broadcast Notice to Mariners file to ensure the chart is fully corrected. Annotate on the chart or a chart correction card all the corrections that have been made; this will make it easier to verify the chart's correction status prior to its next use. Naval ships may need to prepare three sets of charts. One set is for the primary plot, the second set is for the secondary plot, and the third set is for the conning officer and captain. Civilian vessels will prepare one set.
- **Mark the Minimum Depth Contour:** Determine the

minimum depth of water in which the vessel can safely operate and outline that depth contour on the chart. Do this step before doing any other harbor navigation planning. Highlight this outline in a bright color so that it clearly stands out. Carefully examine the area inside the contour and mark the isolated shoals less than the minimum depth which fall inside the marked contour. Determine the minimum depth in which the vessel can operate as follows:

- Minimum Depth = Ship's Draft – Height of Tide +
- Safety Margin + Squat. (See Section 1004 and Section 1018.)
- Remember that often the fathometer's transducer is not located at the section of the hull that extends the furthest below the waterline. Therefore, the indicated depth of water is that below the fathometer transducer, not the depth of water below the vessel's deepest draft.
- **Highlight Selected Visual Navigation Aids (NAVAIDS).** Circle, highlight and label the main navigational aids on the chart. Consult the applicable *Coast Pilot* or *Sailing Directions* to determine a port's best NAVAIDS if the piloting team has not visited the port previously. These aids can be lighthouses, piers, shore features, or tanks; any prominent feature that is displayed on the chart can be used as a NAVAID. Label critical buoys, such as those marking a harbor entrance or a traffic separation scheme. Verify charted lights against the *Light List* or the *List of Lights* to confirm the charted information is correct. This becomes most critical when attempting to identify a light at night. Label NAVAIDS succinctly and clearly. Ensure everyone in the navigation team refers to a NAVAID using the same terminology. This will reduce confusion between the bearing taker, the bearing recorder, and plotter.
- **Highlight Selected Radar NAVAIDS.** Highlight radar NAVAIDS with a triangle instead of a circle. If the NAVAID is suitable for either visual or radar piloting, it can be highlighted with either a circle or a triangle.
- **Plot the Departure/Approach Track.** This process is critical for ensuring safe pilotage. Consult the *Fleet Guide* and *Sailing Directions* for recommendations on the best track to use. Look for any information or regulations published by the local harbor authority. Lacking any of this information, locate a channel or safe route on the chart and plot the vessel's track. Most U.S. ports have well-defined channels marked with buoys. Carefully check the intended track to ensure a sufficient depth of water under the keel will exist for the entire passage. If the scale of the chart permits, lay the track out to the starboard side of the channel to allow for any vessel traffic proceeding in the opposite direction. Many channels are marked by natural or

man-made ranges. The bearings of these ranges should be measured to the nearest 0.1° or noted from the *Light List*, and this value should be marked on the chart. Not only are ranges useful in keeping a vessel on track, they are invaluable for determining gyro error. See Section 1007.

- **Label the Departure/Approach Track.** Label the track course to the nearest 0.5° . Similarly, label the distance of each track leg. Highlight the track courses for easy reference while piloting. Often a navigator might plan two separate tracks, for use during good visibility and the other for poor visibility. Considerations might include concern for the number of turns (fewer turns for poor visibility) or proximity to shoal water (smaller margin for error might be acceptable in good visibili-

ty). In this case, label both tracks as above and appropriately mark when to use each track.

- **Use Advance and Transfer to Find Turning Points.** The distance the vessel moves along its original course from the time the rudder is put over until the new course is reached is called **advance**. The distance the vessel moves perpendicular to the original course during the turn is called **transfer**. The track determined above does not account for these. See Figure 1002b. Use the advance and transfer characteristics of the vessel to determine when the vessel must put its rudder over to gain the next course. From that point, fair in a curve between the original course and the new course. Mark the point on the original course where the vessel must put its rudder over as the **turning point**. See Figure 1002c.

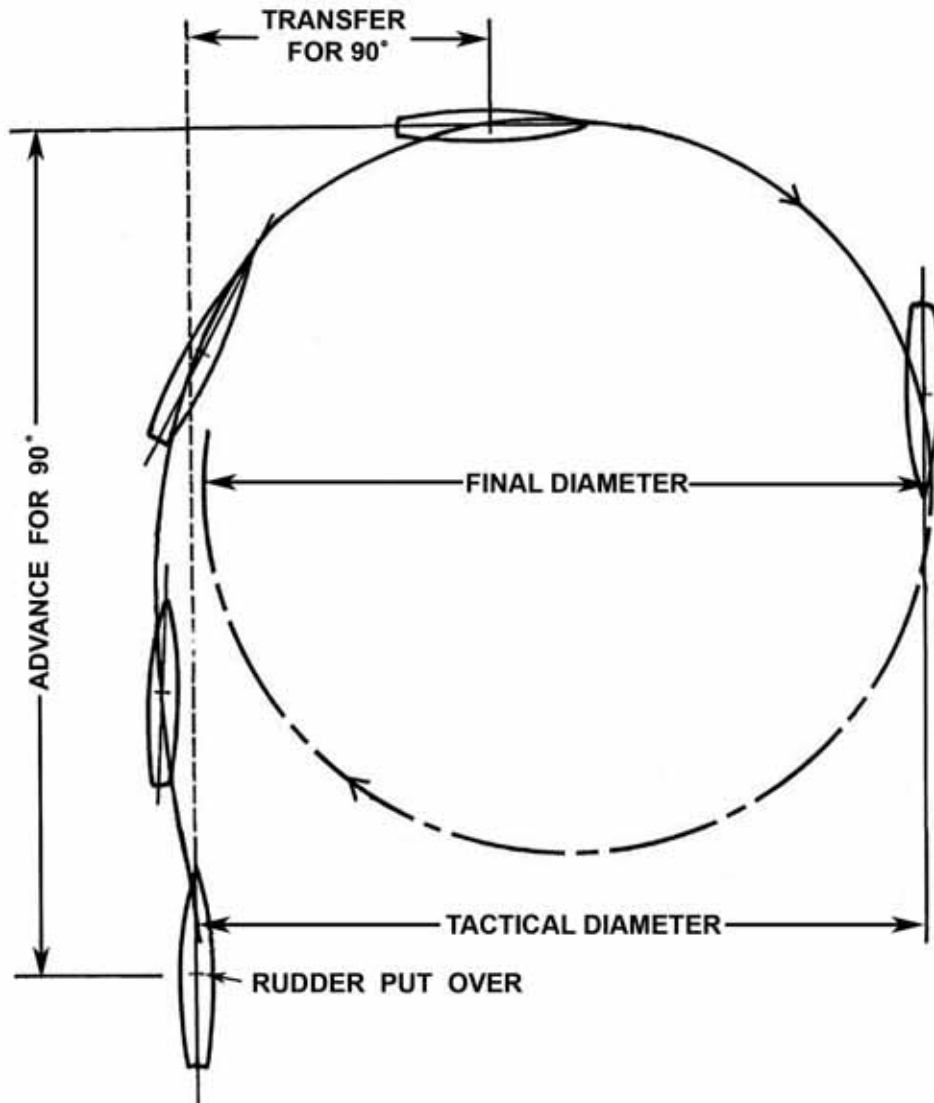

Figure 1002a. Turning circle.

- **Plot Turn Bearings and Ranges.** A **turn bearing** is a predetermined bearing to a charted object from the

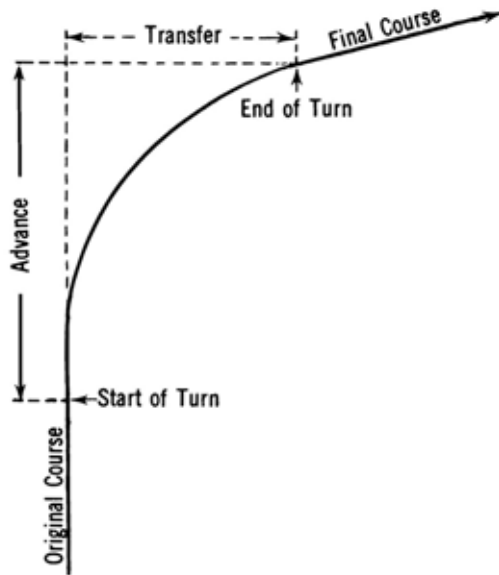

Figure 1002b. Advance and transfer.

track point at which the rudder must be put over in order to make a desired turn. In selecting a NAVAID for a turn bearing, find one as close to abeam as possible at the turning point, and if possible on the inside elbow of the turn. Account for advance and transfer and label the bearing to the nearest 0.1° . A **turn range** is similar, but taken as a radar range to a prominent object ahead or astern. Ideally, both can be used, one as a check against the other.

Example: Figure 1002c illustrates using advance and transfer to determine a turn bearing. A ship proceeding on course 100° is to turn 60° to the left to come on a range which will guide it up a channel. For a 60° turn and the amount of rudder used, the advance is 920 yards and the transfer is 350 yards.

Required: The bearing of flagpole “FP.” when the rudder is put over.

Solution:

- Extend the original course line, AB.
- At a perpendicular distance of 350 yards, the transfer, draw a line A'B' parallel to the original course line AB. The point of intersection, C, of A'B' with the new course line is the place at which the turn is to be completed.
- From C draw a perpendicular, CD, to the original course line, intersecting at D.
- From D measure the advance, 920 yards, back along the original course line. This locates E, the point at which the turn should be started.

- The direction of “FP.” from E, 058° , is the bearing when the turn should be started.

Answer: Bearing 058° .

- **Plot a Slide Bar for Every Turn Bearing:** If the ship is off track immediately prior to a turn, a plotting technique known as the **slide bar** can quickly revise a turn bearing. See Figure 1002d. A slide bar is a line drawn parallel to the new course through the turning point on the original course. The navigator can quickly determine a new turn bearing by dead reckoning ahead from the vessel’s last fix position to where the DR intersects the slide bar. The revised turn bearing is simply the bearing from that intersection point to the turn bearing NAVAID. Draw the slide bar with a different color from that used for the track in order to see the slide bar clearly.

- **Label Distance to Go from Each Turn Point:** At each turning point, label the distance to go until either the ship moors (inbound) or the ship clears the harbor (outbound). For an inbound transit, a vessel’s captain is usually more concerned about time of arrival, so assume a speed of advance and label each turn point with time to go until mooring.

- **Plot Danger Bearings:** Danger bearings warn a navigator s/he may be approaching a navigational hazard too closely. See Figure 1002e. Vector AB indicates a vessel’s intended track. This track passes close to the indicated shoal. Draw a line from the NAVAID H tangent to the shoal. The bearing of that tangent line measured from the ship’s track is 074.0°T . In other words, as long as NAVAID H bears *less than* 074°T as the vessel proceeds down its track, the vessel will not ground on the shoal. Hatch the side of the bearing line on the side of the hazard and label the danger bearing NMT (no more than) 074.0°T . For an added margin of safety, the line does not have to be drawn exactly tangent to the shoal. Perhaps, in this case, the navigator might want to set an error margin and draw the danger bearing at 065°T from NAVAID H. Lay down a danger bearing from any appropriate NAVAID in the vicinity of any hazard to navigation. Ensure the track does not cross any danger bearing.

- **Plot Danger Ranges:** The danger range is analogous to the danger bearing. It is a standoff range from an object to prevent the vessel from approaching a hazard too closely.

- **Label Warning and Danger Soundings:** To determine the danger sounding, examine the vessel’s proposed track and note the minimum expected sounding. The minimum expected sounding is the difference between the shallowest water expected on the transit and the vessel’s maximum draft. Set 90% of this difference as the warning sounding and 80% of this

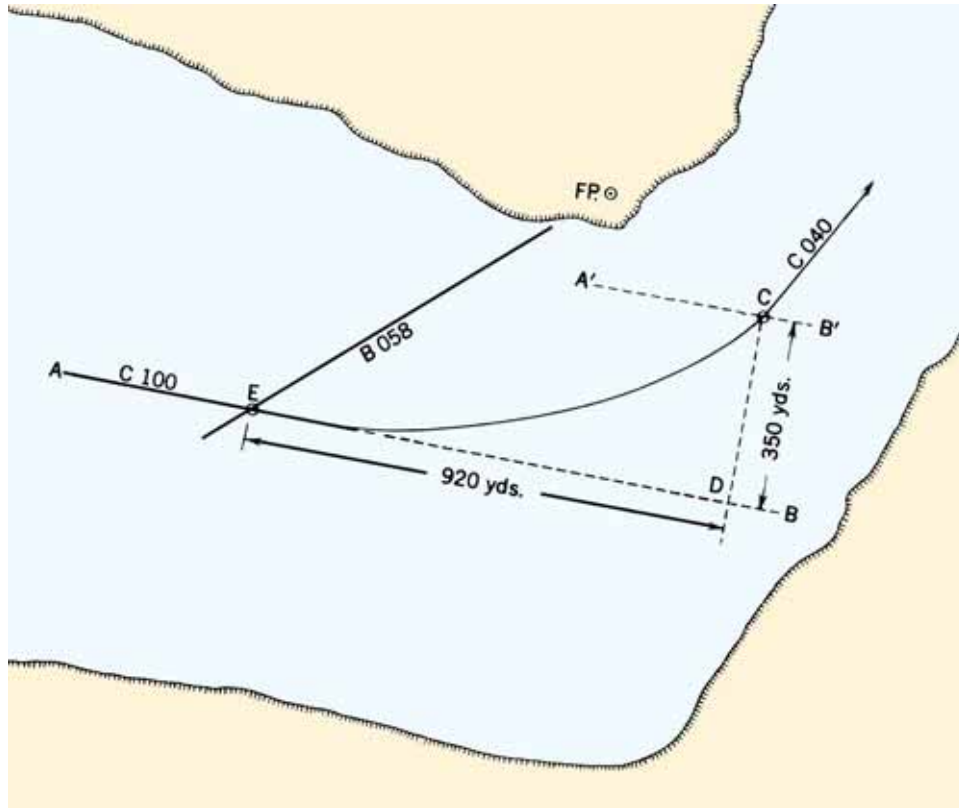

Figure 1002c. Allowing for advance and transfer.

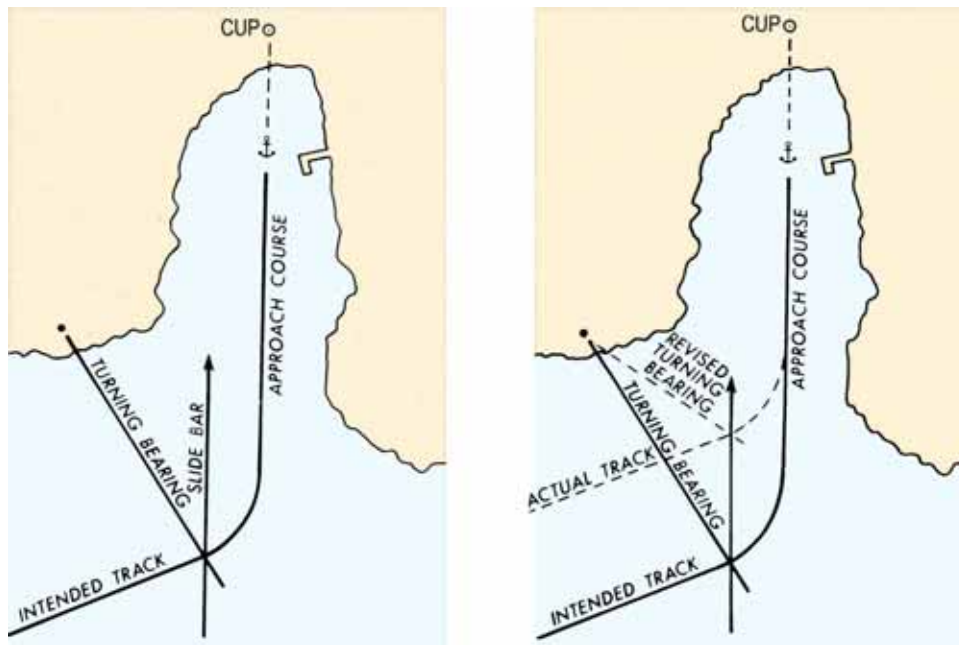

Figure 1002d. The slide bar technique.

difference as the danger sounding. The captain may require lower margins. There may be peculiarities about local conditions or forecast wave and swell that will cause the navigator to choose another method of set-

ting warning and danger soundings. Use the above method if no other means is more suitable. For example: A vessel draws a maximum of 20 feet, and it is entering a channel dredged to a minimum depth of 50

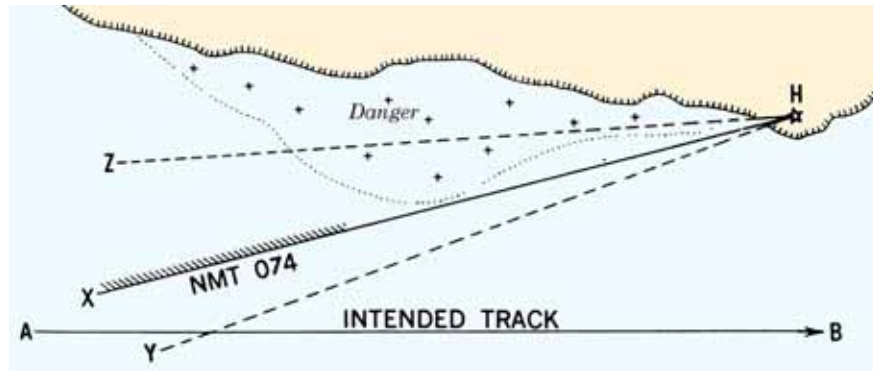

Figure 1002e. A danger bearing, hatched on the dangerous side, labeled with the appropriate bearing.

feet. Set the warning and danger soundings at $0.9 (50\text{ft.} - 20\text{ft.}) = 27\text{ft.}$ and $0.8 (50\text{ft.} - 20\text{ft.}) = 24\text{ft.}$, respectively. Re-evaluate these soundings at different intervals along the track, when the minimum expected sounding may change. Carefully label the points along the track between which these warning and danger soundings apply.

- **Label Air Draft:** Label the minimum height for bridges and other height restrictions.
- **Label Demarcation Line:** Clearly label the point on the ship's track where the Inland and International Rules of the Road apply. This is applicable only when piloting in U.S. ports.
- **Mark Speed Limits Where Applicable:** Often a harbor will have a local speed limit in the vicinity of piers, other vessels, or shore facilities. Mark these speed limits and the points between which they are applicable on the chart.
- **Mark the Point of Pilot Embarkation:** Some ports require vessels over a certain size to embark a pilot. If this is the case, mark the point on the chart where the pilot is to embark.
- **Mark the Tugboat Rendezvous Point:** If the vessel requires a tug to moor, mark the tug rendezvous point on the chart.
- **Mark the Chart Shift Point:** If more than one chart will be required to complete the passage, mark the point where the navigator should shift to the next chart.
- **Harbor Communications:** Mark the point on the chart where the vessel must contact harbor control. Also mark the point where a vessel must contact its parent squadron to make an arrival report (military vessels only).
- **Tides and Currents:** Mark the points on the chart for which the tides and currents were calculated.

1003. Records

Ensure the following records are assembled and personnel assigned to maintain them:

- **Bearing Record Book:** The bearing recorders for the primary and secondary plots should record all the bearings used on their plot during the entire transit. The books should clearly list what NAVAIDS are being used and what method of navigation was being used on their plot. In practice, the primary bearing book will contain mostly visual bearings and the secondary bearing book will contain mostly radar ranges and bearings.
- **Fathometer Log:** In restricted waters, monitor soundings continuously and record soundings every five minutes in the fathometer log. Record all fathometer settings that could affect the sounding display.
- **Deck Log:** This log is the legal record of the passage. Record all ordered course and speed changes. Record all the navigator's recommendations and whether the navigator concurs with the actions of the conning officer. Record all buoys passed, and the shift between international and inland Rules of the Road. Record the name and embarkation of any pilot. Record who has the conn at all times. Record any casualty or important event. The deck log combined with the bearing log should constitute a complete record of the passage.

1004. Tides and Currents

Determining the tidal and current conditions of the port is crucial. This process is covered in depth in Chapter 35. In order to anticipate early or late transit, plot a graph of the tidal range for the 24-hour period centered on the scheduled time of arrival or departure. Depending on a vessel's draft and the harbor's depth, some vessels may be able to transit only at high tide. If this is the case, it is critically important to determine the time and range of the tide correctly.

The magnitude and direction of the current will give the navigator some idea of the **set and drift** the vessel will

experience during the transit. This will allow him or her to plan in advance for any potential current effects in the vicinity of navigational hazards.

NOAA's National Ocean Services (NOS) ceased printing and distributing annual *Tide Tables* in 1995, however, *Tide Tables* are still printed and distributed under license through several commercial publishers. It is far more efficient to use a computer with appropriate software, or the internet, to compute tides and print out the graphs. These graphs can be posted on the bridge at the chart table for ready reference, and copies made for others involved in the piloting process. The NOAA Tide Prediction service can be accessed through the link provided in Figure 1004. Always remember actual conditions may be quite different from predicted data due to weather or other natural phenomena. In addition the Navigator should be aware of any changes in the draft readings caused by ballasting or the off/onload of material.



Figure 1004. NOAA Tide Prediction Service.
https://tidesandcurrents.noaa.gov/tide_predictions.html

1005. Weather

The navigator should obtain a weather report covering the route which s/he intends to transit. This will allow him or her to prepare for any adverse weather by stationing extra lookouts, adjusting speed for poor visibility, and preparing for radar navigation. If the weather is thick, consider standing off the harbor until it clears.

The navigator can receive weather information any number of ways. Military vessels may receive weather reports from their parent squadrons prior to coming into port. Marine band radio carries continuous weather reports. Many vessels are equipped with weather facsimile machines. Some navigators carry cellular phones to reach shoreside personnel and harbor control; these can also be used to get weather reports from NOAA weather stations. If the ship is using a weather routing service for the voyage, it should provide forecasts when asked. Finally, if the vessel has an internet connection, this is an ideal source of weather data. NOAA weather data can be obtained via the link provided in Figure 1005. However s/he obtains the information, the navigator should have a good idea of the weather before entering piloting waters.



Figure 1005. NOAA Weather Data.
<https://www.nws.noaa.gov/wx.html>

1006. The Piloting Brief

Assemble the entire navigation team for a piloting brief prior to entering or leaving port. The vessel's captain and navigator should conduct the briefing. All navigation and bridge personnel should attend. The pilot, if s/he is already on board, should also attend. If the pilot is not onboard when the ship's company is briefed, the navigator should immediately brief them when s/he embarks. The pilot must know the ship's maneuvering characteristics before entering restricted waters. The briefing should cover, as a minimum, the following:

- **Detailed Coverage of the Track Plan:** Go over the planned route in detail. Use the prepared and approved chart as part of this brief. Concentrate especially on all the NAVAIDS and soundings which are being used to indicate danger. Cover the buoyage system in use and the port's major NAVAIDS. Point out the radar NAVAIDS for the radar operator. Often, a *Fleet Guide* or *Sailing Directions* will have pictures of a port's NAVAIDS. This is especially important for the piloting party that has never transited a particular port before. If no pictures are available, consider stationing a photographer to take some for submission to NGA.
- **Harbor Communications:** Discuss the bridge-to-bridge radio frequencies used to raise harbor control. Discuss what channel the vessel is supposed to monitor on its passage into port and the port's communication protocol.
- **Duties and Responsibilities:** Each member of the piloting team must have a thorough understanding of his or her duties and responsibilities. S/He must also understand how his or her part fits into the whole. The radar plotter, for example, must know if radar will be the primary or secondary source of fix information. The bearing recorder must know what fix interval the navigator is planning to use. Each person must be thoroughly briefed on his or her job; there is little time for questions once the vessel enters the channel.

1007. Evolutions Prior to Piloting

The navigator should always accomplish the following evolutions prior to piloting:

- **Testing the Shaft on the Main Engines in the Astern Direction:** This ensures that the ship can answer a backing bell. If the ship is entering port, no special precautions are required prior to this test. If the ship is tied up at the pier preparing to get underway, exercise extreme caution to ensure no way is placed on the ship while testing the main engines, and the area astern of the vessel is clear of lines or other obstructions.
- **Making the Anchor Ready for Letting Go:** Make the anchor ready for letting go and station a watchstander in direct communications with the bridge at the anchor windlass. Be prepared to drop anchor immediately when piloting if required to keep from drifting too close to a navigational hazard.
- **Calculate Gyro Error:** An error of greater than 1.0° T indicates a gyro problem which should be investigated prior to piloting. There are several ways to determine gyro error:
 - Compare the gyro reading with a known accurate heading reference such as an inertial navigator. The difference in the readings is the gyro error.
 - Mark the bearing of a charted range as the range NAVAID's come into line and compare the gyro bearing with the charted bearing. The difference is the gyro error.
 - Prior to getting underway, plot a dockside fix using at least three lines of position. The three LOP's should intersect at a point. Their intersecting in a "cocked hat" indicates a gyro error. Incrementally adjust each visual bearing by the same amount and direction until the fix plots as a pinpoint. The total correction required to eliminate the cocked hat is the gyro error.
 - Measure a celestial body's azimuth or amplitude, or Polaris' azimuth with the gyro, and then compare the measured value with a value computed from the *Sight Reduction Tables* or the *Nautical Almanac*. These methods are covered in detail in Chapter 15.
- Report the magnitude and direction of the gyro error to the navigator and captain. The direction of the error is

determined by the relative magnitude of the gyro reading and the value against which it is compared. When the compass is least, the error is east. Conversely, when the compass is best, the error is west. See Chapter 8.

1008. Inbound Voyage Planning

The vessel's planned estimated time of arrival (ETA) at its mooring determines the vessel's course and speed to the harbor entrance. Arriving at the mooring site on time may be important in a busy port which operates its port services on a tight schedule. Therefore, it is important to plan the arrival accurately. Take the desired time of arrival at the mooring and subtract from that the time it will take to navigate to it from the entrance. The resulting time is when you must arrive at the harbor entrance. Next, measure the distance between the vessel's present location and the harbor entrance. Determine the speed of advance (SOA) the vessel will use to make the transit to the harbor. Use the distance to the harbor and the SOA to calculate what time to leave the present position to make the mooring ETA, or what speed must be made good to arrive on time.

Consider these factors which might affect this decision:

- **Weather:** This is the single most important factor in harbor approach planning because it directly affects the vessel's SOA. The thicker the weather, the more slowly the vessel must proceed. Therefore, if heavy fog or rain is in the forecast, the navigator must allow more time for the transit.
- **Mooring Procedures:** Navigators must take more than distance into account when calculating how long it will take them to pilot to their mooring. If the vessel needs a tug, that will increase the time needed. Similarly, picking up or dropping off a pilot adds time to the transit. It is better to allow a margin for error when trying to add up all the time delays caused by these procedures. It is always easier to avoid arriving early by slowing down than it is to make up lost time by speeding up.
- **Shipping Density:** Generally, the higher the shipping density entering and exiting the harbor, the longer it will take to proceed into the harbor entrance safely.

TRANSITION TO PILOTING

1009. Stationing the Piloting Team

At the appropriate time, station the piloting team. Allow plenty of time to acclimate to the navigational situation and if at night, to the darkness. The number and type of personnel available for the piloting team depend on the vessel. A Navy warship, for example, has more people available for piloting than a merchant ship. Therefore, more than one of the jobs listed below may have to be filled by a single person. The piloting team should consist of:

- **The Captain:** The captain is ultimately responsible for the safe navigation of the vessel. His or her judgment regarding navigation is final. The piloting team acts to support the captain, advising him or her so they can make informed decisions on handling the vessel.
- **The Pilot:** The pilot is usually the only member of the piloting team not a member of the ship's company. The piloting team must understand the relationship between the pilot and the captain. The pilot is perhaps the captain's most important navigational advisor. Gener-

ally, the captain will follow his or her recommendations when navigating an unfamiliar harbor. The pilot, too, bears some responsibility for the safe passage of the vessel; he or she can be censured for errors of judgment which cause accidents. However, the presence of a pilot in no way relieves the captain of having ultimate responsibility for safe navigation. One exception to this rule is in the Panama Canal per 32 CFR 700.857 where the Commanding Officer is relieved of the responsibility for the safe navigation of the vessel to the canal Pilot. The piloting team works to support and advise the captain.

- **The Officer of the Deck (Conning Officer):** In Navy piloting teams, neither the pilot or the captain usually has the **conn**. The Officer of the Deck (OOD) and the Conning Officer are two different watchstanders. The OOD underway is in charge of the safe operation of the ship and supervises the personnel on watch on the bridge. The Conning Officer directs the ship's movements by rudder and engine orders. The captain can take the conn immediately simply by issuing an order to the helm should an emergency arise. The conning officer of a merchant vessel can be either the pilot, the captain, or another watch officer. In any event, the officer having the conn must be clearly indicated in the ship's deck log at all times. Often a single officer will have the deck and the conn. However, sometimes a junior officer will take the conn for training. In this case, different officers will have the deck and the conn. The officer who retains the deck retains the responsibility for the vessel's safe navigation. US Coast Guard vessels normally split the deck and conn.
- **The Navigator:** The vessel's navigator is the officer directly responsible to the ship's captain for the safe navigation of the ship. S/He is the captain's principal navigational advisor. The piloting team works for the captain. The navigator channels the required information developed by the piloting team to the ship's conning officer on recommended courses, speeds, and turns. The navigator also carefully looks ahead for potential navigational hazards and makes appropriate recommendations. S/He is the most senior officer who devotes his or her effort exclusively to monitoring the navigation picture. The captain and the conning officer are concerned with all aspects of the passage, including contact avoidance and other necessary ship evolutions (making up tugs, maneuvering alongside a small boat for personnel transfers, engineering evolutions, and coordinating with harbor control via radio, for example). The navigator, on the other hand, focuses solely on safe navigation. It is his or her job to anticipate dangers, keep themselves apprised of the navigation situation at all times, and manage the team.
- **Bearing Plotting Team:** This team consists, ideally, of three persons. The first person measures the bearings. The second person records the bearings in an official record book. The third person plots the bearings. The bearing taker should be an experienced individual who has traversed the port before and who is familiar with the NAVAIDS. He or she should take their round of bearings as quickly as possible, beam bearings first, minimizing any time delay errors in the resulting fix. The plotter should also be an experienced individual who can quickly and accurately lay down the required bearings. The bearing recorder can be one of the junior members of the piloting team.
- **The Radar Operator:** The radar operator has one of the more difficult jobs of the team. The radar is as important for collision avoidance as it is for navigation. Therefore, this operator must often "time share" the radar between these two functions. Determining the amount of time spent on these functions falls within the judgment of the captain and the navigator. If the day is clear and the traffic heavy, the captain may want to use the radar mostly for collision avoidance. As the weather worsens, obscuring visual NAVAIDS, the importance of radar for safe navigation increases. The radar operator must be given clear guidance on how the captain and navigator want the radar to be operated.
- **Plot Supervisors:** On many military ships, the piloting team will consist of two plots: the primary plot and the secondary plot. The navigator should designate the type of navigation that will be employed on the primary plot. All other fix sources should be plotted on the secondary plot. The navigator can function as the primary plot supervisor. A senior, experienced individual should be employed as a secondary plot supervisor. The navigator should frequently compare the positions plotted on both plots as a check on the primary plot.
- There are three major reasons for maintaining a primary and secondary plot. First, as mentioned above, the secondary fix sources provide a good check on the accuracy of visual piloting. Large discrepancies between visual and radar positions may point out a problem with the visual fixes that the navigator might not otherwise suspect. Secondly, the navigator often must change the primary means of navigation during the transit. S/He may initially designate visual bearings as the primary fix method only to have a sudden storm or fog obscure the visual NAVAIDS. If s/he shifts the primary fix means to radar, s/he has a track history of the correlation between radar and visual fixes. Finally, the piloting team often must shift charts several times during the transit. When the old chart is taken off the plotting table and before the new chart is secured, there is a period of time when no chart is in use. Maintaining a secondary plot eliminates this complication. Ensure the secondary plot is not shifted prior to getting the new primary plot chart down on the chart table. In this case, there will always be a chart available on which to

pilot. Do not consider the primary chart shifted until the new chart is properly secured and the plotter has transferred the last fix from the original chart onto the new chart.

- **Fathometer Operator:** Run the fathometer continuously and station an operator to monitor it. Do not rely on audible alarms to key your attention to this critically important piloting tool. The fathometer operator must know the warning and danger soundings for the area the vessel is transiting. Most fathometers can display either total depth of water or depth under the keel. Set the fathometer to display depth under the keel. The navigator must check the sounding at each fix and compare that value to the charted sounding. A discrepancy between these values is cause for immediate action to take another fix and check the ship's position.

1010. Harbor Approach (Inbound Vessels Only)

The piloting team must make the transition from coastal navigation to piloting smoothly as the vessel approaches restricted waters. There is no rigid demarcation between coastal navigation and piloting. Often visual NAVAIDS are visible miles from shore where GPS is easier to use. The navigator should take advantage of this overlap when

approaching the harbor. Plotting GPS, and visual fixes concurrently ensures that the piloting team has correctly identified NAVAIDS and that the different types of systems are in agreement. Once the vessel is close enough to the shore such that sufficient NAVAIDS (at least three with sufficient bearing spread) become visible, the navigator should order visual bearings only for the primary plot and shift all other fixes to the secondary plot, unless the decision has been made to proceed with ECDIS as the primary system.

Take advantage of the coastal navigation and piloting overlap to shorten the fix interval gradually. The navigator must use his or her judgment in adjusting fix intervals. If the ship is steaming inbound directly towards the shore, set a fix interval such that two fix intervals lie between the vessel and the nearest danger. Upon entering restricted waters, the piloting team should be plotting visual fixes at three minute intervals.

Commercial vessels with GPS, planning the harbor transit with a pilot, will approach a coast differently. The transition from ocean to coastal to harbor approach navigation will proceed as visual aids and radar targets appear and are plotted. Once the pilot is aboard, the captain/pilot team may elect to navigate visually, depending on the situation.

TAKING FIXES WHILE PILOTING

Safe navigation while piloting requires frequent fixing of the ship's position whether the vessel is supported by ECDIS or not. If an ECS is in use, it should be considered only a supplement to the paper navigation plot, which legally must still be maintained. As long as the manual plot and the ECS plot are in agreement, the ECS is a valuable tool which shows the navigator where the ship is at any instant, not two or three minutes ago when the last fix was taken. It cannot legally take the place of the paper chart and the manual plot, but it can provide an additional measure of assurance that the ship is in safe water and alert the navigator to a developing dangerous situation before the next round of bearings or ranges.

The next several articles will discuss the three major manual methods used to fix a ship's position when piloting: crossing lines of position, copying satellite data, or advancing a single line of position. Using one method does not exclude using other methods. The navigator must obtain as much information as possible and employ as many of these methods as necessary.

1011. Types of Fixes

While the intersection of two LOP's constitutes a **fix** under one definition, and only an estimated position by another, the prudent navigator will always use at least three LOP's if they are available, so that an error is apparent if

they don't meet in a point. Some of the most commonly used methods of obtaining LOP's are discussed below:

- **Fix by Bearings:** The navigator can take and plot bearings from two or more charted objects. This is the most common and often the most accurate way to fix a vessel's position. Bearings may be taken directly to charted objects, or tangents of points of land. See Figure 1011a. The intersection of these lines constitutes a fix. A position taken by bearings to buoys should not be considered a fix, but an estimated position (EP), because buoys swing about their watch circle and may be out of position.
- **Fix by Ranges:** The navigator can plot a fix consisting of the intersection of two or more range arcs from charted objects. S/He can obtain an object's range in several ways:
 1. **Radar Ranges:** See Figure 1011b. The navigator may take ranges to two fixed objects. The intersection of the range arcs constitutes a fix. S/He can plot ranges from any point on the radar scope which s/he can correlate on his or her chart. Remember that the shoreline of low-lying land may move many yards in an area of large tidal range, and swampy areas may be indistinct.
 2. **Stadimeter Ranges:** Given a known height of a NAVAID, one can use a stadimeter to determine its

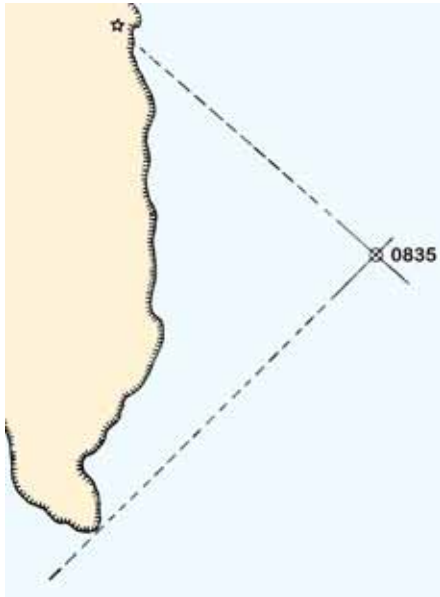

Figure 1011a. A fix by two bearing lines.

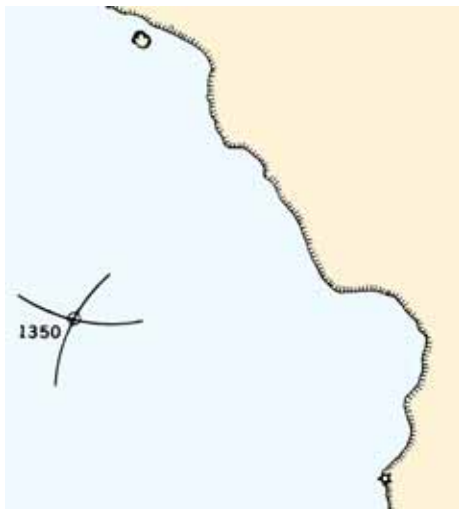

Figure 1011b. A fix by two radar ranges.

range. See Figure 1011c for a representation of the geometry involved. Generally, stadimeters contain a height scale on which is set the height of the object. The observer then directs his or her line of sight through the stadimeter to the base of the object being observed. Finally, s/he adjusts the stadimeter's range index until the object's top reflection is "brought down" to the visible horizon. Read the object's range off the range index.

- **3. Sextant Vertical Angles:** Measure the vertical angle from the top of the NAVAID to the waterline below the NAVAID. Enter Table 16 to determine the distance of the NAVAID. The navigator must know the height of the NAVAID above sea level to use this table; it can be found in the *Light List*.

- **4. Sonar Ranges:** If the vessel is equipped with a sonar suite, the navigator can use sonar echoes to determine ranges to charted underwater objects. It may take some trial and error to set the active signal strength at a value that will give a strong return and still not cause excessive reverberation. Check local harbor restrictions on energizing active sonar. Avoid active sonar transmissions in the vicinity of divers.
- **Fix by Bearing and Range:** This is a hybrid fix of LOP's from a bearing and range to a single object. The radar is the only instrument that can give simultaneous range and bearing information to the same object. (A sonar system can also provide bearing and range information, but sonar bearings are far too inaccurate to use in piloting.) Therefore, with the radar, the navigator can obtain an instantaneous fix from only one NAVAID. This unique fix is shown in Figure 1011d. This makes the radar an extremely useful tool for the piloting team. The radar's characteristics make it much more accurate determining range than determining bearing; therefore, two radar ranges are preferable to a radar range and bearing.
- **Electronic Range Finder:** A modern electronic range finder may be used for the same purpose as a stadimeter. The Coast Guard uses electronic range finders to augment the stadimeter during underway replenishment and other station keeping operations when vessels are too close for accurate radar ranging.
- **Fix by Range Line and Distance:** When the vessel comes in line with a range, plot the bearing to the range (while checking compass error in the bargain) and cross this LOP with a distance from another NAVAID. Figure 1011e shows this fix.

1012. The Running Fix

When only one NAVAID is available from which to obtain bearings, use a technique known as the **running fix**. Use the following method:

- Plot a bearing to a NAVAID (LOP 1).
- Plot a second bearing to a NAVAID (either the same NAVAID or a different one) at a later time (LOP 2).
- Advance LOP 1 to the time when LOP 2 was taken.
- The intersection of LOP 2 and the advanced LOP 1 constitute the running fix.

Figure 1012a represents a ship proceeding on course 020° , speed 25 knots. At 1505, the plotter plots an LOP to a lighthouse bearing 310° . The ship can be at any point on this 1505 LOP. Some possible points are represented as points A, B, C, D, and E in Figure 1012a. Six minutes later the ship will have traveled 2.5 miles in direction 020° . If the ship was at A at 1505, it will be at A' at 1511. However, if the

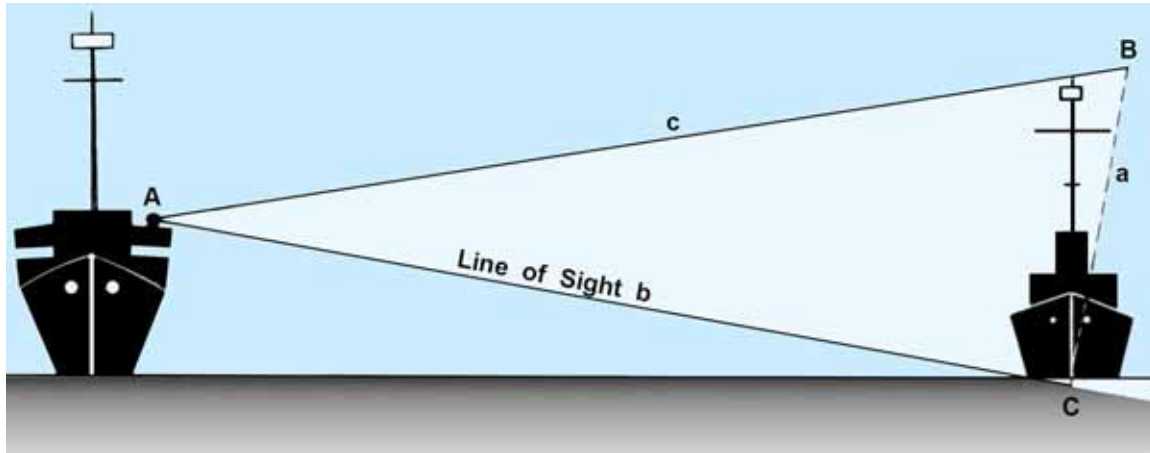

Figure 1011c. Principle of stadimeter operation.

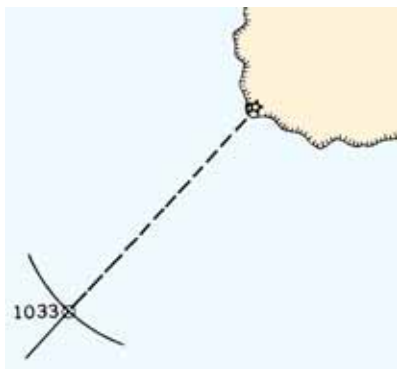

Figure 1011d. A fix by range and bearing of a single object.

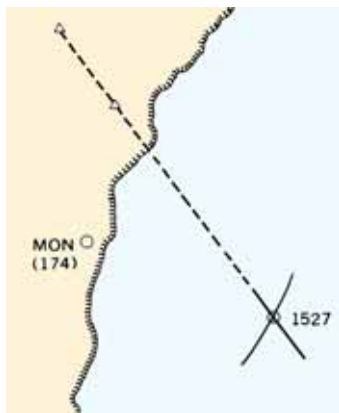

Figure 1011e. A fix by a range and distance.

position at 1505 was B, the position at 1511 will be B'. A similar relationship exists between C and C', D and D', E and E'. Thus, if any point on the original LOP is moved a distance equal to the distance run in the direction of the motion, a line through this point parallel to the original line of position represents all possible positions of the ship at the later time. This process is called **advancing** a line of position. Moving a

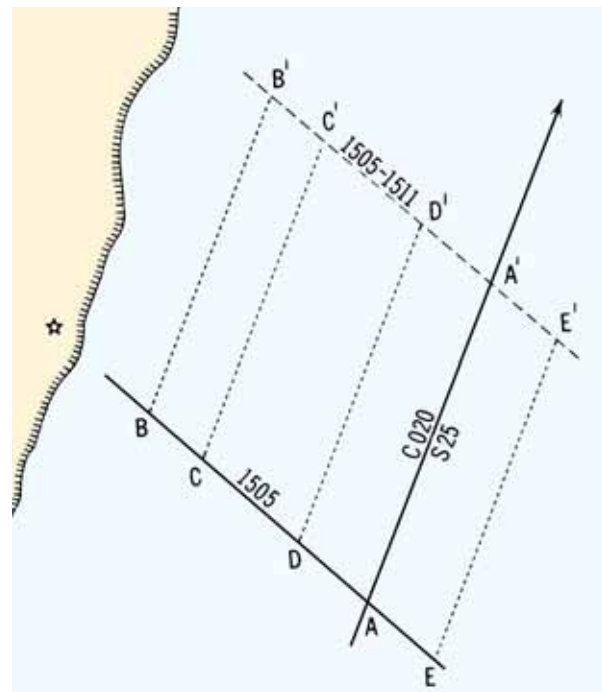

Figure 1012a. Advancing a line of position.

line back to an earlier time is called **retiring** a line of position.

When advancing a line of position, account for course changes, speed changes, and set and drift between the two bearing lines. Three methods of advancing an LOP are discussed below:

Method 1: See Figure 1012b. To advance the 1924 LOP to 1942, first apply the best estimate of set and drift to the 1942 DR position and label the resulting position point B. Then, measure the distance between the dead reckoning position at 1924 (point A) and point B. Advance the LOP a distance equal to the distance between points A and B. Note that LOP A'B' is in the same direction as line AB.

Method 2: See Figure 1012c. Advance the NAVAIDS

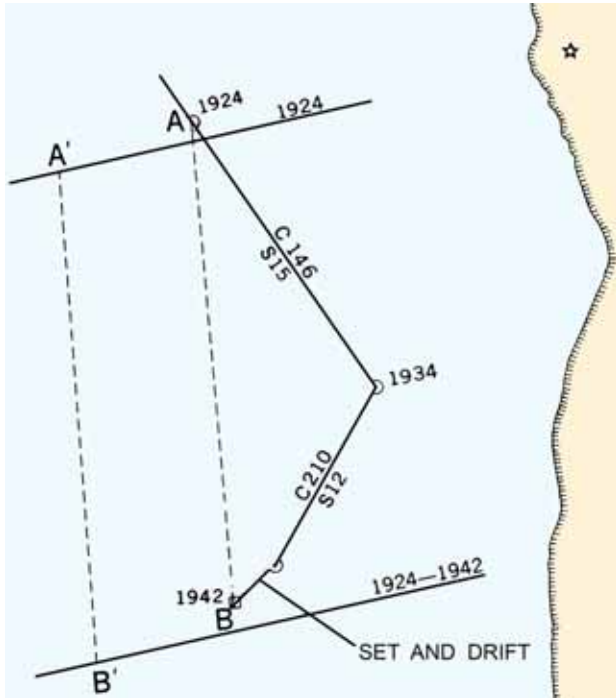

Figure 1012b. Advancing a line of position with a change in course and speed, allowing for set and drift.

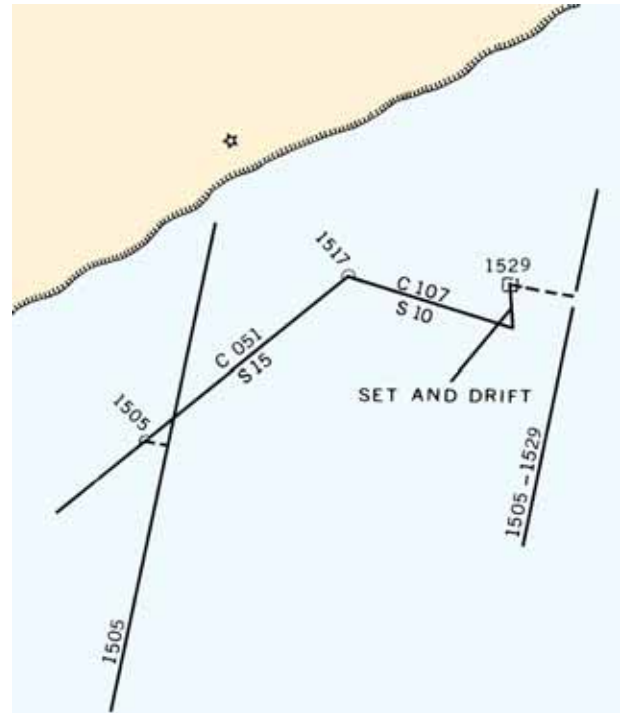

Figure 1012d. Advancing a line of position by its relation to the dead reckoning.

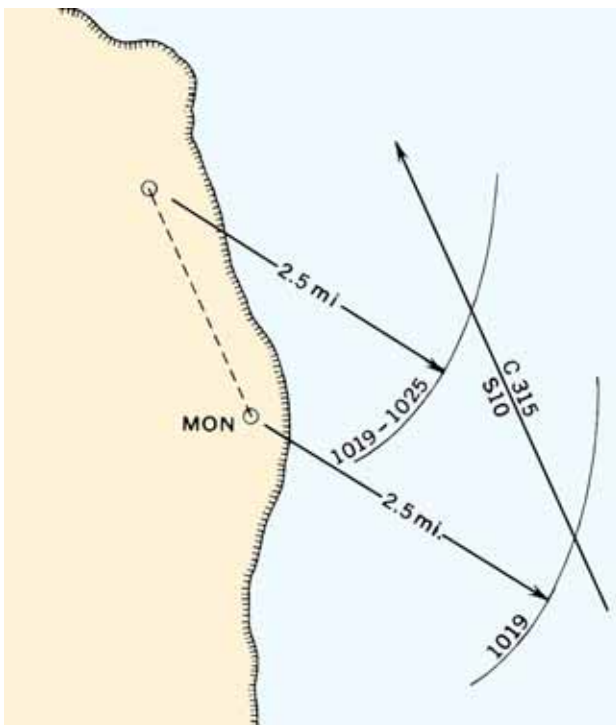

Figure 1012c. Advancing a circle of position.

position on the chart for the course and distance traveled by the vessel and draw the line of position from the NAVAIDS advanced position. This is the most satisfactory method for advancing a circle of position.

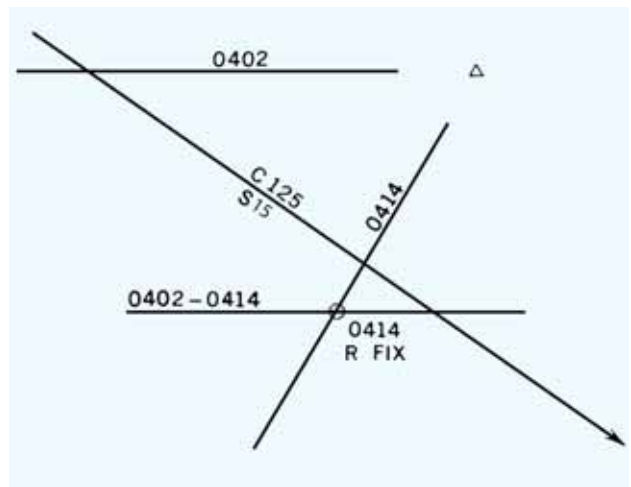

Figure 1012e. A running fix by two bearings on the same object.

Method 3: See Figure 1012d. To advance the 1505 LOP to 1529, first draw a correction line from the 1505 DR position to the 1505 LOP. Next, apply a set and drift correction to the 1529 DR position. This results in a 1529 estimated position (EP). Then, draw from the 1529 EP a correction line of the same length and direction as the one drawn from the 1505 DR to the 1505 LOP. Finally, parallel the 1505 bearing to the end of the correction line as shown.

Label an advanced line of position with both the time of observation and the time to which the line is adjusted.

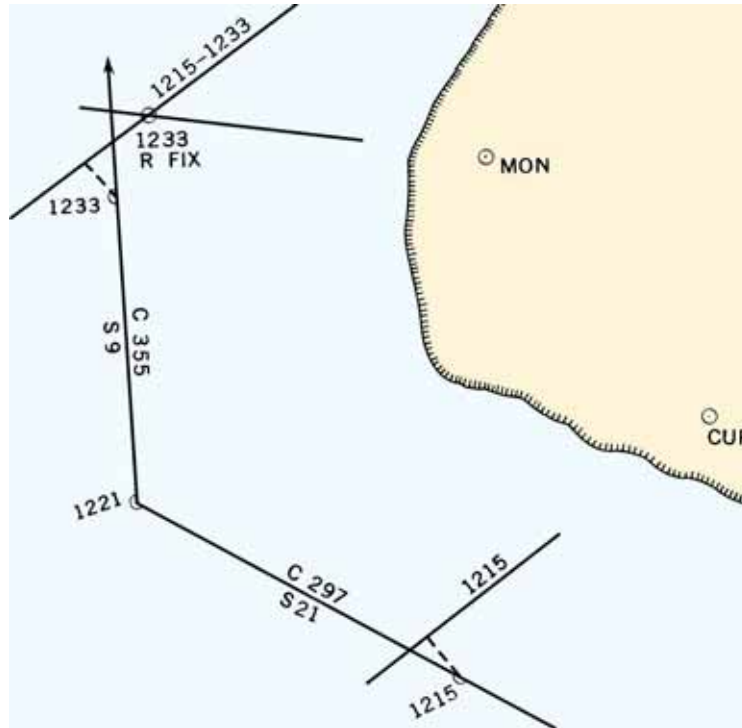

Figure 1012f. A running fix with a change of course and speed between observations on separate landmarks.

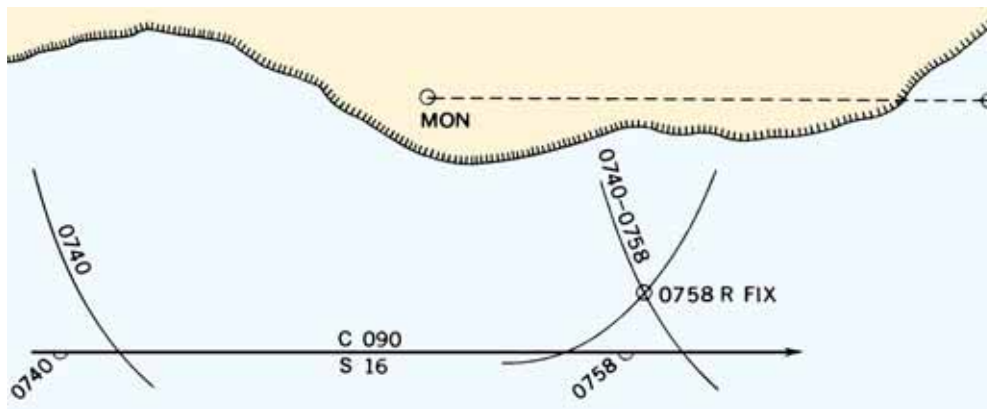

Figure 1012g. A running fix by two circles of position.

Figure 1012e through Figure 1012g demonstrate three running fixes. Figure 1012e illustrates the case of obtaining a running fix with no change in course or speed between taking two bearings on the same NAVAID. Figure 1012f illustrates a running fix with changes in a

vessel's course and speed between taking two bearings on two different objects. Finally, Figure 1012g illustrates a running fix obtained by advancing range circles of position using the second method discussed above.

PILOTING PROCEDURES

The previous section discussed the methods for fixing the ship's position. This section discusses integrating the manual fix methods discussed above, and the use of the fathometer, into a piloting procedure. The navigator must develop his or her piloting procedure to meet several requirements. He or she must obtain enough information to

fix the position of the vessel without question. He or she must also plot and evaluate this information. Finally, s/he must relay his or her evaluation and recommendation to the vessel's conning officer. This section examines some considerations to ensure the navigator accomplishes all these requirements quickly and effectively. Of course, if

ECDIS is the primary plot, manual methods as discussed here are for backup use.

1013. Fix Type and Fix Interval

The preferred piloting fix is taken from visual bearings from charted fixed NAVAIDS. Plot visual bearings on the primary plot and plot all other fixes on the secondary plot. If poor visibility obscures visual NAVAIDS, shift to radar piloting on the primary plot. If neither visual nor radar piloting is available, consider standing off until the visibility improves.

The interval between fixes in restricted waters should usually not exceed three minutes. Setting the fix interval at three minutes optimizes the navigator's ability to assimilate and evaluate all available information. He or she must relate it to charted navigational hazards and to his or her vessel's intended track. It should take a well trained plotting team no more than 30 seconds to measure, record, and plot three bearings to three separate NAVAIDS. The navigator should spend the majority of the fix interval time interpreting the information, evaluating the navigational situation, and making recommendations to the conning officer.

If three minutes goes by without a fix, inform the captain and try to plot a fix as soon as possible. If the delay was caused by a loss of visibility, shift to radar piloting. If the delay was caused by plotting error, take another fix. If the navigator cannot get a fix down on the plot for several more minutes, consider slowing or stopping the ship until its position can be fixed. Never continue a passage through restricted waters if the vessel's position is uncertain.

The secondary plot supervisor should maintain the same fix interval as the primary plot. Usually, this means s/he should plot a radar fix every three minutes. S/He should plot other fix sources (GPS fixes, for example) at an interval sufficient for making meaningful comparisons between fix sources. Every third fix interval, s/he should pass a radar fix to the primary plot for comparison with the visual fix. S/He should inform the navigator how well all the fix sources plotted on the secondary plot are tracking.

1014. The Piloting Routine

Following a cyclic routine ensures the timely and efficient processing of data and forms a smoothly functioning piloting team. It quickly gives the information which the navigator needs to make informed recommendations to the conning officer and captain.

Repeat this routine at each fix interval beginning when the ship gets underway until it clears the harbor (outbound) or when the ship enters the harbor until it is moored (inbound).

The routine consists of the following steps:

- Take, plot and label a fix.
- Calculate set and drift from the DR position.
- Reset the DR from the fix and DR two fixes ahead.

- **Plotting the Fix:** This involves coordination between the navigator, bearing taker(s), recorder, and plotter. The navigator will call for each fix at the DR time. The bearing taker must measure his or her bearings as quickly as possible, beam bearings first, fore and aft last, on the navigator's mark. The recorder will write the bearings in the book, and the plotter will plot them immediately.
- **Labeling the Fix:** The plotter should clearly mark a visual fix with a circle or an electronic fix with a triangle. Clearly label the time of each fix. A visual running fix should be circled, marked "R Fix" and labeled with the time of the second LOP. Keep the chart neat and uncluttered when labeling fixes.
- **Dead Reckoning Two Fix Intervals Ahead:** After labeling the fix, the plotter should dead reckon the fix position ahead two fix intervals. The navigator should carefully check the area marked by this DR for any navigational hazards. If the ship is approaching a turn, update the turn bearing as discussed in Section 1002.
- **Calculate Set and Drift at Every Fix:** Calculating set and drift is covered in Chapter 9. Calculate these values at every fix and inform the captain and conning officer. Compare the actual values of set and drift with the predicted values from the current graph discussed in Section 1004. Evaluate how the current is affecting the vessel's position in relation to the track and recommend courses and speeds to regain the planned track. Because the navigator can determine set and drift only when comparing fixes and DR's plotted for the same time, take fixes exactly at the times for which a DR has been plotted. Repeat this routine at each fix interval beginning when the ship gets underway until it clears the harbor (outbound) or when the ship enters the harbor until she is moored (inbound).
- **Piloting Routine When Turning:** Modify the cyclic routine slightly when approaching a turn. Adjust the fix interval so that the plotting team has a fix plotted approximately one minute before a scheduled turn. This gives the navigator sufficient time to evaluate the position in relation to the planned track, DR ahead to the slide bar to determine a new turn bearing, relay the new turn bearing to the conning officer, and then monitor the turn bearing to mark the turn.

Approximately 30 seconds before the time to turn, train the alidade on the turn bearing NAVAID. Watch the bearing of the NAVAID approach the turn bearing. About 1° away from the turn bearing, announce to the conning officer: "Stand by to turn." Slightly before the turn bearing is indicated, report to the conning officer: "Mark the turn." Make this report slightly before the bearing is reached because it takes the conning officer a finite amount of time to acknowledge the report and order the helmsman to put over the rudder. Additionally, it takes a finite amount of

time for the helmsman to turn the rudder and for the ship to start to turn. If the navigator waits until the turn bearing is indicated to report the turn, the ship will turn too late.

Once the ship is steady on the new course, immediately take another fix to evaluate the vessel's position in relation to the track. If the ship is not on the track after the turn, calculate and recommend a course to the conning officer to regain the track.

1015. Using the Fathometer

Use the fathometer to determine whether the depth of water under the keel is sufficient to prevent the ship from grounding and to check the actual water depth with the charted water depth at the fix position. The navigator must compare the charted sounding at every fix position with the fathometer reading and report to the captain any discrepancies. Taking continuous soundings in restricted waters is mandatory.

See the discussion of calculating the warning and danger soundings in Section 1002. If the warning sounding is

received, then slow the ship, fix the ship's position more frequently, and proceed with extreme caution. Ascertain immediately where the ship is in the channel; if the minimum expected sounding was noted correctly, the warning sounding indicates the vessel may be leaving the channel and standing into shoal water. Notify the vessel's captain and conning officer immediately.

If the danger sounding is received, take immediate action to get the vessel back to deep water. Reverse the engines and stop the vessel's forward movement. Turn in the direction of the deepest water before the vessel loses steerageway. Consider dropping the anchor to prevent the ship from drifting aground. The danger sounding indicates that the ship has left the channel and is standing into immediate danger. It requires immediate corrective action by the ship's conning officer, navigator, and captain to avoid disaster.

Many underwater features are poorly surveyed. If a fathometer trace of a distinct underwater feature can be obtained along with accurate position information, send the fathometer trace and related navigational data to NGA for entry into the Digital Bathymetric Data Base.

PILOTING TO AN ANCHORAGE

1016. Choosing an Anchorage

Most U.S. Navy vessels receive instructions in their movement orders regarding the choice of anchorage. Merchant ships are often directed to specific anchorages by harbor authorities. However, lacking specific guidance, the mariner should choose his or her anchoring positions using the following criteria:

- **Depth of Water:** Choose an area that will provide sufficient depth of water through an entire range of tides. Water too shallow will cause the ship to go aground, and water too deep will allow the anchor to drag.
- **Type of Bottom:** Choose the bottom that will best hold the anchor. Avoid rocky bottoms and select sandy or muddy bottoms if they are available.
- **Proximity to navigational Hazards:** Choose an anchorage as far away as possible from known navigational hazards.
- **Proximity to Adjacent Ships:** Anchor well away from adjacent vessels; ensure that another vessel will not swing over your own anchor on a current or wind shift.
- **Proximity to Harbor Traffic Lanes:** Anchor clear of traffic lanes and ensure that the vessel will not swing into the channel on a current or wind shift.
- **Weather:** Choose an area with the weakest winds and currents.
- **Availability of NAVAIDS:** Choose an anchorage with several NAVAIDS available for monitoring the ship's

position when anchored.

1017. Navigational Preparations for Anchoring

It is usually best to follow an established procedure to ensure an accurate positioning of the anchor, even when anchoring in an open roadstead. The following procedure is representative. See Figure 1017.

Locate the selected anchoring position on the chart. Consider limitations of land, current, shoals, and other vessels when determining the direction of approach. Where conditions permit, make the approach heading into the current. Close observation of any other anchored vessels will provide clues as to which way the ship will lie to her anchor. If wind and current are strong and from different directions, ships will lie to their anchors according to the balance between these two forces and the draft and trim of each ship. Different ships may lie at different headings in the same anchorage depending on the balance of forces affecting them.

Approach from a direction with a prominent NAVAID, preferably a range, available dead ahead to serve as a steering guide. If practicable, use a straight approach of at least 1200 yards to permit the vessel to steady on the required course. Draw in the approach track, allowing for advance and transfer during any turns. In Figure 1017, the chimney was selected as this steering bearing. A turn range may also be used if a radar-prominent object can be found directly ahead or astern.

Next, draw a circle with the selected position of the anchor as the center, and with a radius equal to the distance between the hawsepipe and pelorus, alidade, or

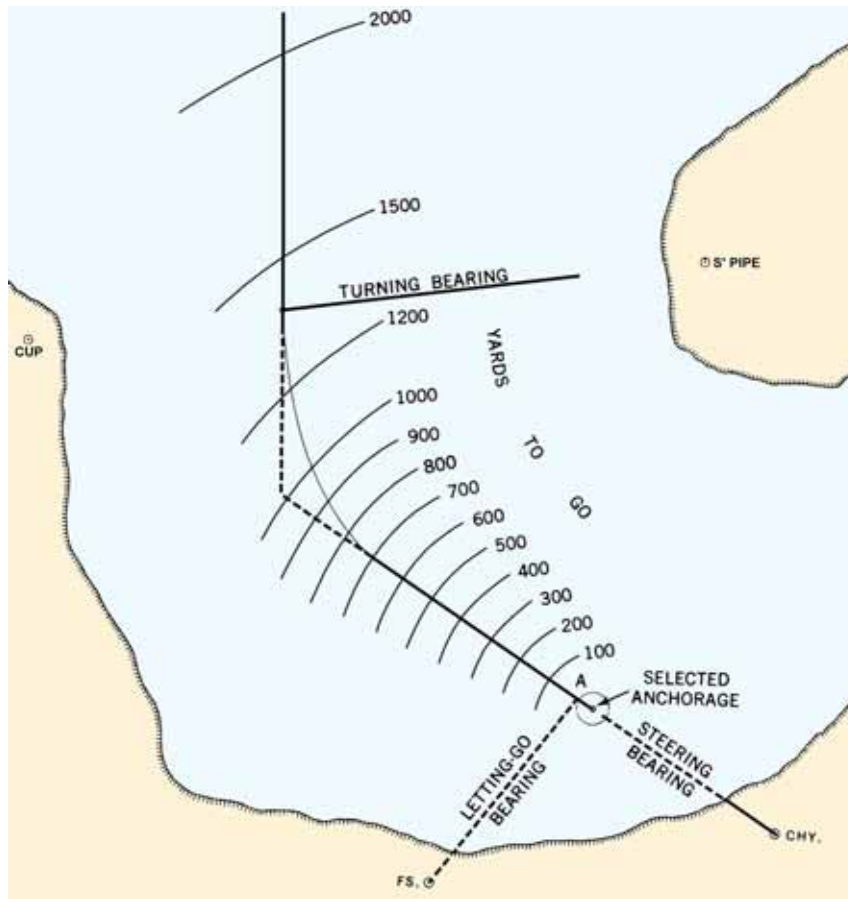

Figure 1017. Anchoring.

periscope used for measuring bearings. This circle is marked "A" in Figure 1017. The intersection of this circle and the approach track is the position of the vessel's bearing-measuring instrument at the moment of letting the anchor go. Select a NAVAID which will be on the beam when the vessel is at the point of letting go the anchor. This NAVAID is marked "FS" in Figure 1017. Determine what the bearing to that object will be when the ship is at the drop point and measure this bearing to the nearest 0.1° T. Label this bearing as the letting go bearing.

During the approach to the anchorage, plot fixes at frequent intervals. The navigator must advise the conning officer of any tendency of the vessel to drift from the desired track. The navigator must frequently report to the conning officer the distance to go, permitting adjustment of the speed so that the vessel will be dead in the water or have very slight sternway when the anchor is let go. To aid in determining the distance to the drop point, draw and label a number of range arcs as shown in Figure 1017 representing distances to go to the drop point.

At the moment of letting the anchor go, take a fix and plot the vessel's exact position on the chart. This is important in the construction of the swing and drag circles discussed below. To draw these circles accurately,

determine the position of the vessel at the time of letting go the anchor as accurately as possible.

Veer the anchor chain to a length equal to five to seven times the depth of water at the anchorage. The exact amount to veer is a function of both vessel type and severity of weather expected at the anchorage. When calculating the scope of anchor chain to veer, take into account the maximum height of tide.

Once the ship is anchored, construct two separate circles around the ship's position when the anchor was dropped. These circles are called the **swing circle** and the **drag circle**. Use the swing circle to check for navigational hazards and use the drag circle to ensure the anchor is holding.

The swing circle's radius is equal to the sum of the ship's length and the scope of the anchor chain released. This represents the maximum arc through which a ship can swing while riding at anchor if the anchor holds. Examine this swing circle carefully for navigational hazards, interfering contacts, and other anchored shipping. Use the lowest height of tide expected during the anchoring period when checking inside the swing circle for shoal water.

The drag circle's radius equals the sum of the hawsepole to pelorus distance and the scope of the chain released. Any

bearing taken to check on the position of the ship should, if the anchor is holding, fall within the drag circle. If a fix falls outside of that circle, then the anchor is dragging. If the vessel has a GPS or system with an off-station alarm, set the alarm at the drag circle radius, or slightly more.

In some cases, the difference between the radii of the swing and drag circles will be so small that, for a given chart scale, there will be no difference between the circles when plotted. If that is the case, plot only the swing circle and treat that circle as both a swing and a drag circle. On the other hand, if there is an appreciable difference in radii between the circles when plotted, plot both on the chart. Which method to use falls within the sound judgment of the

navigator.

When determining if the anchor is holding or dragging, the most crucial period is immediately after anchoring. Fixes should be taken frequently, at least every three minutes, for the first thirty minutes after anchoring. The navigator should carefully evaluate each fix to determine if the anchor is holding. If the anchor is holding, the navigator can then increase the fix interval. What interval to set falls within the judgment of the navigator, but the interval should not exceed 30 minutes. If an ECDIS or GPS is available, use its off-station alarm feature for an additional safety factor.

NAVIGATIONAL ASPECTS OF SHIP HANDLING

1018. Effects Of Banks, Channels, and Shallow Water

A ship moving through shallow water experiences pronounced effects from the proximity of the nearby bottom. Similarly, a ship in a channel will be affected by the proximity of the sides of the channel. These effects can easily cause errors in piloting which lead to grounding. The effects are known as **squat**, **bank cushion**, and **bank suction**. They are more fully explained in texts on shiphandling, but certain navigational aspects are discussed below.

Squat is caused by the interaction of the hull of the ship, the bottom, and the water between. As a ship moves through shallow water, some of the water it displaces rushes under the vessel to rise again at the stern. This causes a venturi effect, decreasing upward pressure on the hull. Squat makes the ship sink deeper in the water than normal and slows the vessel. The faster the ship moves through shallow water, the greater is this effect; groundings on both charted and uncharted shoals and rocks have occurred because of this phenomenon, when at reduced speed the ship could have safely cleared the dangers. When navigating in shallow water, the navigator must reduce speed to avoid squat. If bow and stern waves nearly perpendicular the direction of travel are noticed, and the vessel

slows with no change in shaft speed, squat is occurring. Immediately slow the ship to counter it. Squatting occurs in deep water also, but is more pronounced and dangerous in shoal water. The large waves generated by a squatting ship also endanger shore facilities and other craft.

Bank cushion is the effect on a ship approaching a steep underwater bank at an oblique angle. As water is forced into the narrowing gap between the ship's bow and the shore, it tends to rise or pile up on the landward side, causing the ship to sheer away from the bank.

Bank suction occurs at the stern of a ship in a narrow channel. Water rushing past the ship on the landward side exerts less force than water on the opposite or open water side. This effect can actually be seen as a difference in draft readings from one side of the vessel to the other, and is similar to the venturi effect seen in squat. The stern of the ship is forced toward the bank. If the ship gets too close to the bank, it can be forced sideways into it. The same effect occurs between two vessels passing close to each other.

These effects increase as speed increases. Therefore, in shallow water and narrow channels, navigators should decrease speed to minimize these effects. Skilled pilots may use these effects to advantage in particular situations, but the average mariner's best choice is slow speed and careful attention to piloting.

ADVANCED PILOTING TECHNIQUES

1019. Assuming Current Values to Set Safety Margins for Running Fixes

Current affects the accuracy of a running fix. Consider, for example, the situation of an unknown head current. In Figure 1019a, a ship is proceeding along a coast, on course 250° speed 12 knots. At 0920 light A bears 190°, and at 0930 it bears 143°. If the earlier bearing line is advanced a distance of 2 miles (10 minutes at 12 knots) in the direction of the course, the running fix is as shown by the solid lines. However, if there is a head current of 2 knots, the ship is making good a speed

of only 10 knots, and in 10 minutes will travel a distance of only $1\frac{2}{3}$ miles. If the first bearing line is advanced this distance, as shown by the broken line, the actual position of the ship is at B. This actual position is nearer the shore than the running fix actually plotted. A following current, conversely, would show a position too far from the shore from which the bearing was measured.

If the navigator assumes a following current when advancing his or her LOP, the resulting running fix will plot further from the NAVAID than the vessel's actual position. Conversely, if s/he assumes a head current,

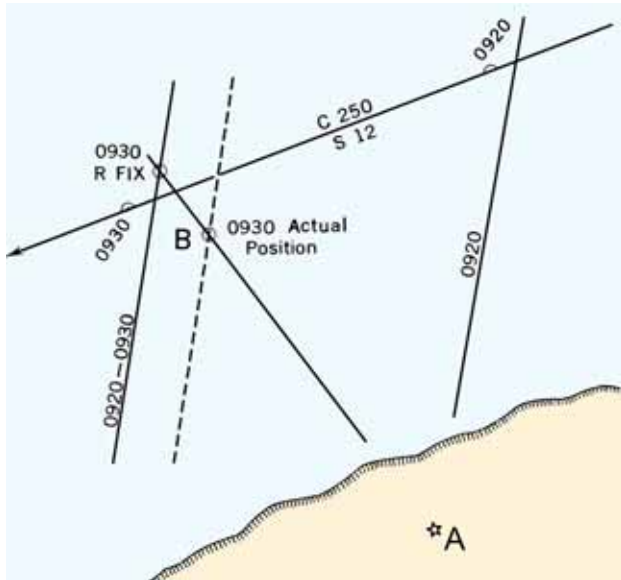

Figure 1019a. Effect of a head current on a running fix.

the running fix will plot closer to the NAVAID than the vessel's actual position. To ensure a margin of safety when plotting running fix bearings to a NAVAID on shore, always assume the current slows a vessel's speed over ground. This will cause the running fix to plot closer to the shore than the ship's actual position.

When taking the second running fix bearing from a different object, maximize the speed estimate if the second object is on the same side and farther forward, or on the opposite side and farther aft, than the first object was when observed.

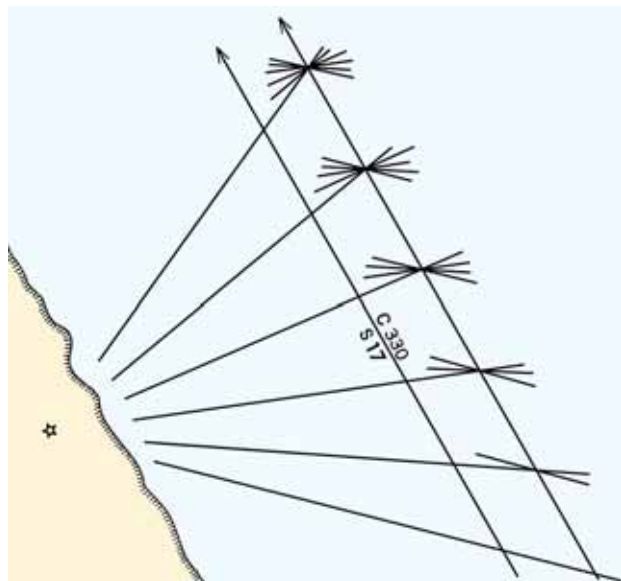

Figure 1019b. A number of running fixes with a following current.

All of these situations assume that danger is on the

same side as the object observed first. If there is either a head or following current, a series of running fixes based upon a number of bearings of the same object will plot in a straight line parallel to the course line, as shown in Figure 1019b. The plotted line will be too close to the object observed if there is a head current and too far out if there is a following current. The existence of the current will not be apparent unless the actual speed over the ground is known. The position of the plotted line relative to the dead reckoning course line is not a reliable guide.

1020. Determining Track Made Good by Plotting Running Fixes

A current oblique to a vessel's course will also result in an incorrect running fix position. An oblique current can be detected by observing and plotting several bearings of the same object. The running fix obtained by advancing one bearing line to the time of the next one will not agree with the running fix obtained by advancing an earlier line. See Figure 1020a. If bearings A, B, and C are observed at five-minute intervals, the running fix obtained by advancing B to the time of C will not be the same as that obtained by advancing A to the time of C, as shown in Figure 1020a.

Whatever the current, the navigator can determine the direction of the track made good (assuming constant current and constant course and speed). Observe and plot three bearings of a charted object O. See Figure 1020b. Through O draw XY in any direction. Using a convenient scale, determine points A and B so that OA and OB are proportional to the time intervals between the first and second bearings and the second and third bearings, respectively. From A and B draw lines parallel to the second bearing line, intersecting the first and third bearing lines at C and D, respectively. The direction of the line from C and D is the track made good.

The distance of the line CD in Figure 1020b from the track is in error by an amount proportional to the ratio of the speed made good to the speed assumed for the solution. If a good fix (not a running fix) is obtained at some time before the first bearing for the running fix, and the current has not changed, the track can be determined by drawing a line from the fix, in the direction of the track made good. The intersection of the track with any of the bearing lines is an actual position.

1021. Fix by Distance of an Object by Two Bearings (Table 18)

Geometrical relationships can define a running fix. In Figure 1021, the navigator takes a bearing on NAVAID D. The bearing is expressed as degrees right or left of course. Later, at B, s/he takes a second bearing to D; similarly, s/he takes a bearing at C, when the landmark is broad on the beam. The navigator knows the angles at A, B, and C and the distance run between points. The various triangles can be solved using

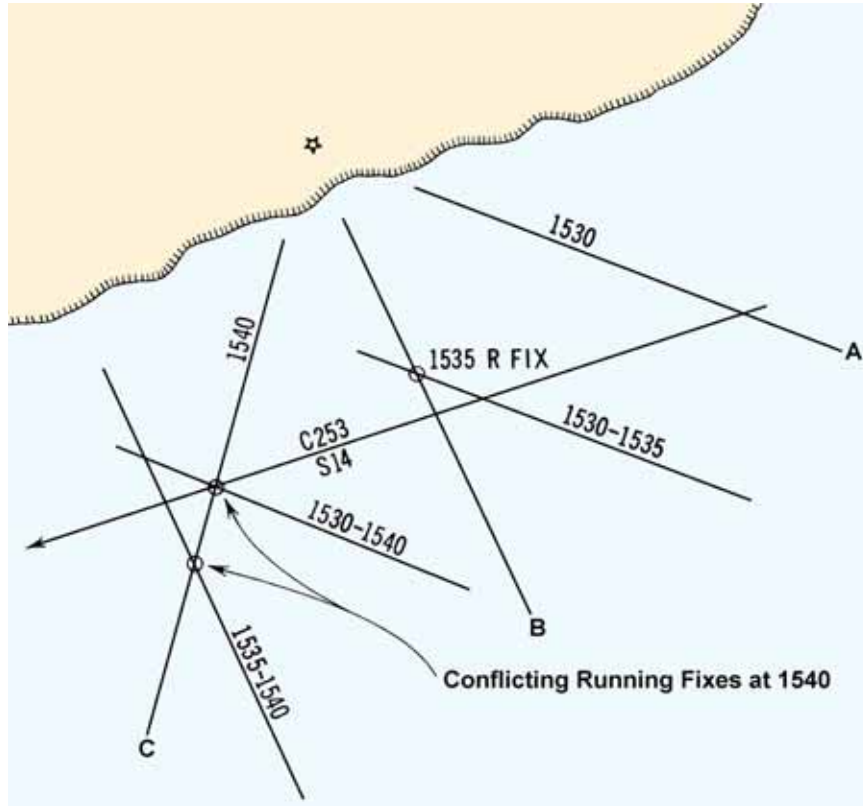

Figure 1020a. Detecting the existence of an oblique current, by a series of running fixes.

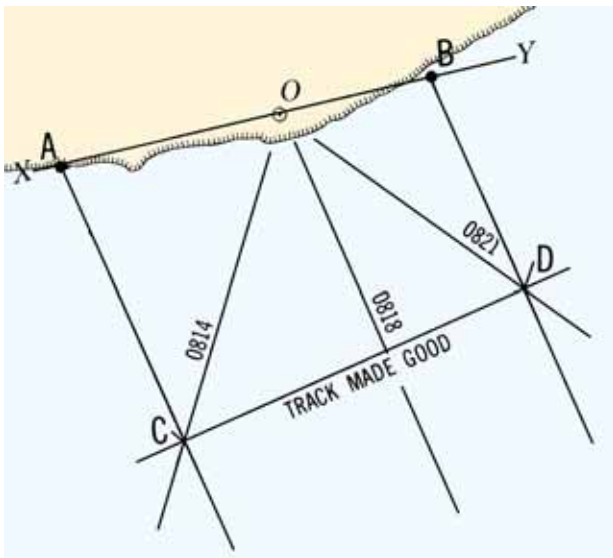

Figure 1020b. Determining the track made good.

Table 18. From this table, the navigator can calculate the lengths of segments AD, BD, and CD. S/He knows the range and bearing; s/he can then plot an LOP. S/He can then advance these LOP's to the time of taking the CD bearing to plot a running fix.

Enter the table with the difference between the course

and first bearing (angle BAD in Figure 1021) along the top of the table and the difference between the course and second bearing (angle CBD) at the left of the table. For each pair of angles listed, two numbers are given. To find the distance from the landmark at the time of the second bearing (BD), multiply the distance run between bearings (in nautical miles) by the first number from Table 18. To find the distance when the object is abeam (CD), multiply the distance run between A and B by the second number from the table. If the run between bearings is exactly 1 mile, the tabulated values are the distances sought.

Example: A ship is steaming on course 050° , speed 15 knots. At 1130 a lighthouse bears 024° , and at 1140 it bears 359° .

Required:

- Distance from the light at 1140.
- Distance from the light when it is broad on the port beam.

Solution:

- The difference between the course and the first bearing ($050^\circ - 24^\circ$) is 26° , and the difference between the course and the second bearing ($050^\circ + 360^\circ - 359^\circ$) is 51° .
- From Table 18, the two numbers (factors are 1.04 and 0.81, found by interpolation).
- The distance run between bearings is 2.5 miles (10

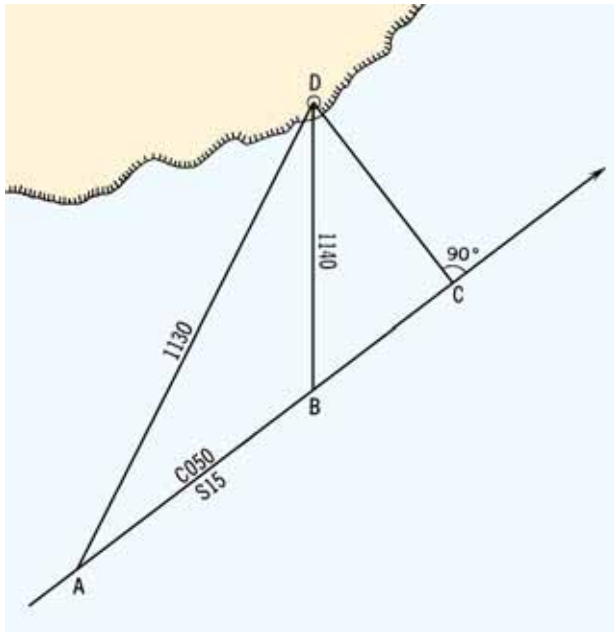

Figure 1021. Triangles involved in a Table 18 running fix.

minutes at 15 knots).

- The distance from the lighthouse at the time of the second bearing is $2.5 \times 1.04 = 2.6$ miles.
- The distance from the lighthouse when it is broad on the beam is $2.5 \times 0.81 = 2.0$ miles.

Answer: (1) D 2.6 mi., (2) D 2.0 mi.

This method yields accurate results only if the helmsman has steered a steady course and the navigator uses the vessel's speed over ground.

MINIMIZING ERRORS IN PILOTING

1022. Common Errors

Piloting requires a thorough familiarity with principles involved, constant alertness, and judgment. A study of groundings reveals that the cause of most is a failure to use or interpret available information. Among the more common errors are:

- Failure to obtain or evaluate soundings
- Misidentification of aids to navigation
- Failure to use available navigational aids effectively
- Failure to correct charts
- Failure to adjust a magnetic compass or keep a table of corrections
- Failure to apply deviation
- Failure to apply variation
- Failure to check gyro and magnetic compass readings regularly
- Failure to keep a dead reckoning plot
- Failure to plot new information
- Failure to properly evaluate information
- Poor judgment
- Failure to use information in charts and navigational publications
- Poor navigation team organization
- Failure to "keep ahead of the vessel"

- Failure to have backup navigational methods in place
- Failure to recognize degradation of electronically obtained LOP's or lat./long. positions
- Failure to slow down when in doubt of ship's location

Some of the errors listed above are mechanical and some are matters of judgment. Conscientiously applying the principles and procedures of this chapter will go a long way towards eliminating many of the mechanical errors. However, the navigator must guard against the feeling that in following a checklist s/he has eliminated all sources of error. A navigator's judgment is just as important as his or her checklists.

1023. Minimizing Errors with a Two Bearing Plot

When measuring bearings from two NAVAIDS, the fix error resulting from an error held constant for both observations is minimized if the angle of intersection of the bearings is 90° . If the observer in Figure 1023a is located at point T and the bearings of a beacon and cupola are observed and plotted without error, the intersection of the bearing lines lies on the circumference of a circle passing through the beacon, cupola, and the observer. With constant error, the angular difference between the bearings of the beacon and the cupola is not affected. Thus, the angle formed at point F by the bearing lines plotted with constant error is equal to the angle formed at point T by the bearing lines plotted without error. From geometry it is known that angles having their apexes on the circumference of a circle and that are subtended by the same chord are equal. Since

the angles at points T and F are equal and the angles are subtended by the same chord, the intersection at point F lies on the circumference of a circle passing through the beacon, cupola, and the observer.

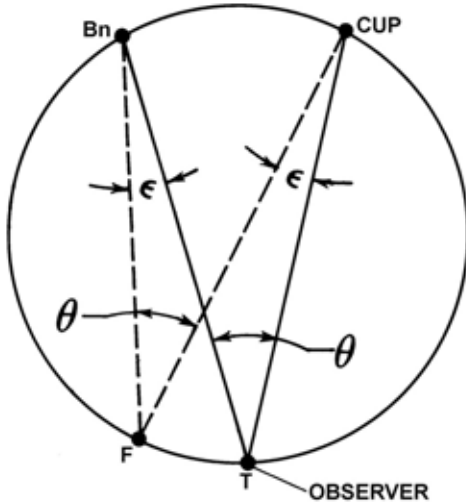

Figure 1023a. Two-bearing plot.

Assuming only constant error in the plot, the direction of displacement of the two-bearing fix from the position of the observer is in accordance with the sign (or direction) of the constant error. However, a third bearing is required to determine the direction of the constant error.

Assuming only constant error in the plot, the two-bearing fix lies on the circumference of the circle passing through the two charted objects observed and the observer. The fix error, the length of the chord FT in Figure 1023b, depends on the magnitude of the constant error ϵ , the distance between the charted objects, and the cosecant of the angle of cut, angle θ . In Figure 1023b,

$$\text{The fix error} = FT = \frac{BC \csc \theta}{2}$$

where ϵ is the magnitude of the constant error, BC is the length of the chord BC, and θ is the angle of the LOP's intersection.

Since the fix error is a function of the cosecant of the angle of intersection, it is least when the angle of intersection is 90°. As illustrated in Figure 1023c, the error increases in accordance with the cosecant function as the angle of intersection decreases. The increase in the error becomes quite rapid after the angle of intersection has decreased to below about 30°. With an angle of intersection of 30°, the fix error is about twice that at 90°.

1024. Finding Compass Error by Trial and Error

If several fixes obtained by bearings on three objects

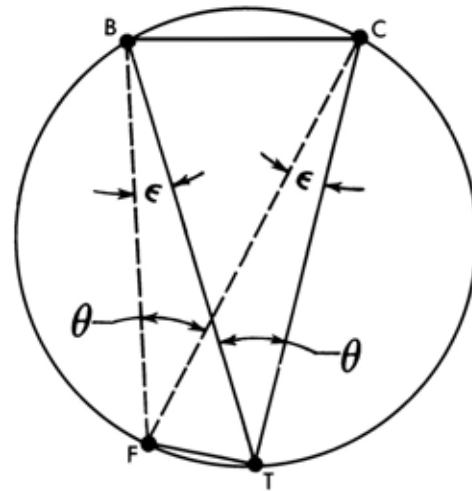

Figure 1023b. Two-bearing plot with constant error.

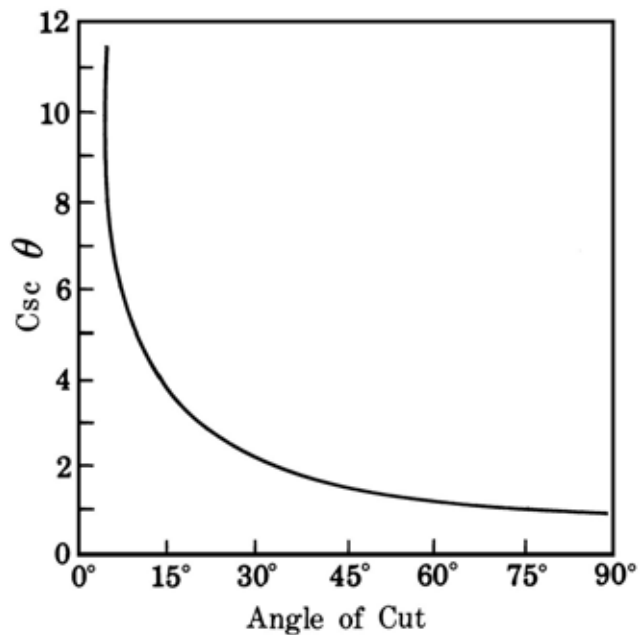

Figure 1023c. Error of two-bearing plot.

produce triangles of error of about the same size, there might be a constant error in observing or plotting the bearings. If applying of a constant error to all bearings results in a pinpoint fix, apply such a correction to all subsequent fixes. Figure 1024 illustrates this technique. The solid lines indicate the original plot, and the broken lines indicate each line of position moved 3° in a clockwise direction.

Employ this procedure carefully. Attempt to find and eliminate the error source. The error may be in the gyrocompass, the repeater, or the bearing transmission system. Compare the resulting fix positions with a satellite position,

a radar position, or the charted sounding. A high degree of correlation between these three independent positioning

systems and an “adjusted” visual fix is further confirmation of a constant bearing error.

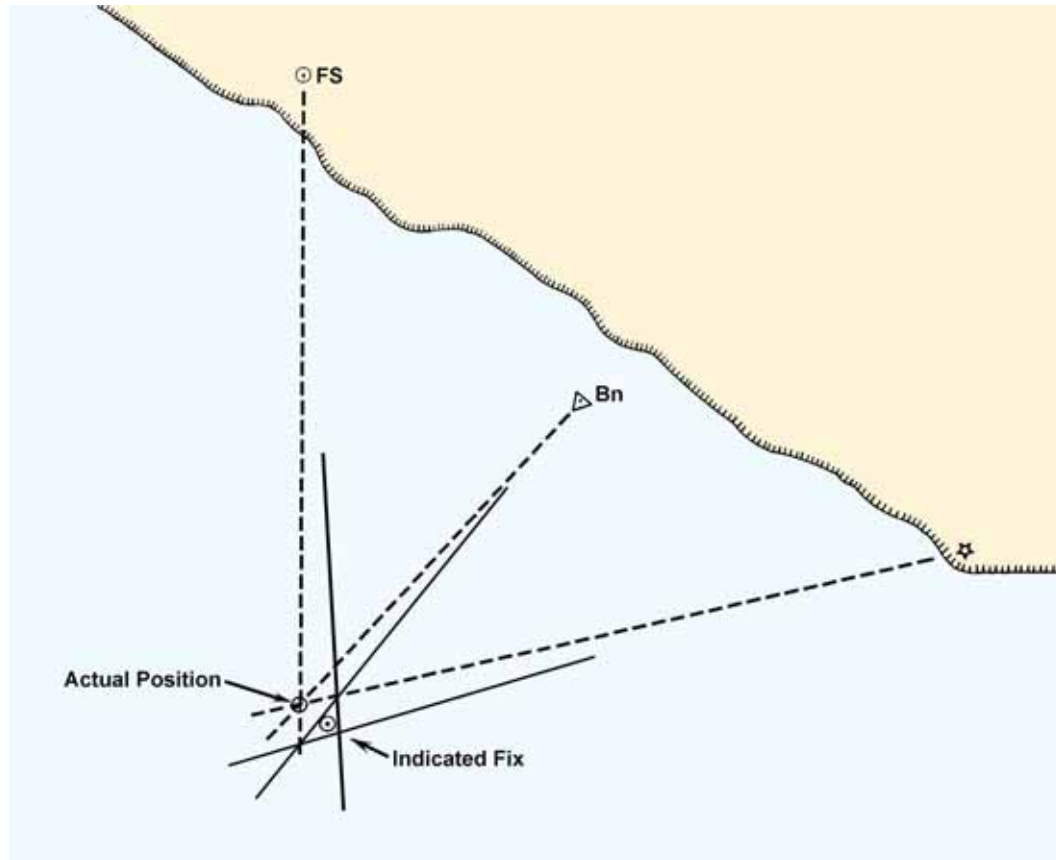

Figure 1024. Adjusting a fix for constant error.

TRAINING

1025. Piloting Simulators

Civilian piloting training has traditionally been a function of both maritime academies and on-the-job experience. The latter is usually more valuable, because there is no substitute for experience in developing judgment. In addition to at-sea training, the US Navy trains Surface Warfare Officers in Navigation and Shiphandling utilizing Conning Officer Virtual Environment (COVE) simulators. Junior Officers to Senior Commanding officers use these frequently throughout their careers to improve their skills and train on the various types of vessels they may serve on. Military vessels in general have a much clearer definition of responsibilities, as well as more people to carry them out, than civilian ships, so training is generally more thorough and targeted to specific skills.

Computer technology has made possible the development of computerized ship simulators by the US Navy and Coast Guard, which allow piloting experience to be gained without risking accidents at sea and without incurring underway expenses. Simulators enable shipboard navigation

teams to train and complete required navigation drills. Simulators range from simple micro-computer-based software to a completely equipped ship’s bridge with radar, engine controls, 360° horizon views, programmable sea motions, and the capability to simulate almost any navigational situation. See Figure 1025a.

A different type of simulator consists of scale models of ships. The models, actually small craft of about 20-30 feet, have hull forms and power-to-weight ratios similar to various types of ships, primarily supertankers, and the operator pilots the vessel from a position such that his or her view is from the craft’s “bridge.” These are primarily used in training pilots and masters in docking maneuvers with exceptionally large vessels. For more about scale model shiphandling see Figure 1025b for a link to Port Revel.

The first computer ship simulators came into use in the late 1970s. Several years later the U.S. Coast Guard began accepting a limited amount of simulator time as “sea time” for licensing purposes. They can simulate virtually any conditions encountered at sea or in piloting waters, including land, aids to navigation, ice, wind, fog, snow, rain, and



Figure 1025a. Navigational bridge simulator.



Figure 1025b. Port Revel. <http://www.portrevel.com>.

lightning. The system can also be programmed to simulate hydrodynamic effects such as shallow water, passing vessels, current, and tugs.

Virtually any type of vessel can be simulated, including tankers, bulkers, container ships, tugs and barges, yachts, and military vessels. Similarly, any given navigational situation can be modeled, including passage through any chosen harbor, river, or passage, convoy operations, meeting and passing situations at sea and in harbors.

Simulators are used not only to train mariners, but also to test feasibility of port and harbor plans and visual aids to navigation system designs. This allows pilots to “navigate” simulated ships through simulated harbors before construction begins to test the adequacy of channels,

turning basins, aids to navigation, and other factors.

A full-capability simulator consists of a ship’s bridge which may have motion and noise/vibration inputs, a programmable visual display system which projects a simulated picture of the area surrounding the vessel in both daylight and night modes, image generators for the various inputs to the scenario such as video images and radar, a central data processor, a human factors monitoring system which may record and videotape bridge activities for later analysis, and a control station where instructors control the entire scenario.

Some simulators are part-task in nature, providing specific training in only one aspect of navigation such as radar navigation, collision avoidance, or night navigation.

While there is no substitute for on-the-job training, simulators are extremely cost effective systems which can be run for a fraction of the cost of an actual vessel. Further, they permit trainees to learn from mistakes with no possibility of an accident, they can model an infinite variety of scenarios, and they permit replay and reassessment of each maneuver.

CHAPTER 11

USE OF SEXTANT IN PILOTING

FUNDAMENTAL CONCEPTS

1100. Introduction

The marine sextant has long been an accurate means for fixing a vessel's position in coastal and confined water circumstances. However, with the advent of reliable gyrocompass technologies, followed by the introduction of precise electronic positioning systems like GPS, use of the marine sextant for terrestrial navigation has declined to such an extent that it is seldom employed during normal piloting conditions. This is unfortunate because the sextant can be used to great advantage in situations where other methods or tools, including the gyrocompass, are inadequate. The applications of the sextant during daylight in coastal waters, harbor approaches, and more confined waters may be summarized as follows:

1. fixing to make a safe transit of hazardous waters;
2. fixing to take a specific geographic position;
3. fixing to establish accurately the position of the anchor on anchoring;
4. fixing to determine whether or not the ship is dragging anchor;
5. using horizontal and vertical danger angles;
6. using vertical angles to determine distance off;
7. fixing to determine the positions of uncharted objects, or to verify the positions of charted features;
8. using the sextant to validate the accuracy of navigation by other means.

Because the use of the sextant has declined, many navigators, unfortunately, do not have the proficiency necessary to use it to advantage in those situations where other methods may be inadequate. Proficiency in the use of the sextant can be invaluable in situations where even a small error in either observing or plotting cross bearings could result in navigation blunder.

1101. Three-point problem

Normally, three charted objects are selected for measuring horizontal sextant angles to determine the observer's position, one of the objects being common to each angular measurement. With simultaneous or nearly simultaneous measurements of the horizontal angles between each pair of charted objects, the observer establishes two circles of position. For each pair of objects, there is only one circle which passes through the two objects and the observer's po-

sition. Thus, there are two circles, intersecting at two points as shown in Figure 1101a, which pass through the observer's position at *T*.

Since the observer knows that s/he is not at the intersection at *B*, s/he must be at *T*.

The solution of what is known as the **three-point problem** is effected by placing the hairlines of the arms of a plastic three-arm protractor over the three observed objects on the chart as shown in Figure 1101b. With the arms so placed, the center of the protractor disk is over the observer's position on the chart at the time of the measurements.

1102. Solution without three-arm protractor

Although the conventional solution of the three-point problem is obtained by placing the arms of a three-arm protractor over the three observed objects on the chart, the use of the protractor is not necessary. The use of the protractor may not be practicable because of limited space and facilities for plotting, as in a small open boat. Where a common charted object cannot be used in the horizontal angle observations, a means other than the three-arm protractor must be employed to determine the position of the observer. Also, point fixes as obtained from the three-arm protractor can be misleading if the navigator has limited skill in evaluating the strengths of the three-point solutions.

In plotting the three-point fix without a three-arm protractor, the procedure is to find the center of each circle of position, sometimes called **circle of equal angle** (Figure 1102a), and then, about such center, to strike an arc of radius equal to the distance on the chart from the circle center to one of the two objects through which the circle passes. The same procedure is applied to the other pair of objects to establish the fix at the intersection of the two arcs.

Some of the methods for finding the center of a circle of equal angle are described in the following text.

The center of the circle of equal angle lies on the perpendicular bisector of the baseline of the pair of objects. With the bisector properly graduated (Figure 1102b), one need only to place one point of the compasses at the appropriate graduation, the other point at one of the observed objects, and then to strike the circle of equal angle or an arc of it in the vicinity of the DR.

The bisector can be graduated through calculation or by means of either the simple protractor or the three-arm

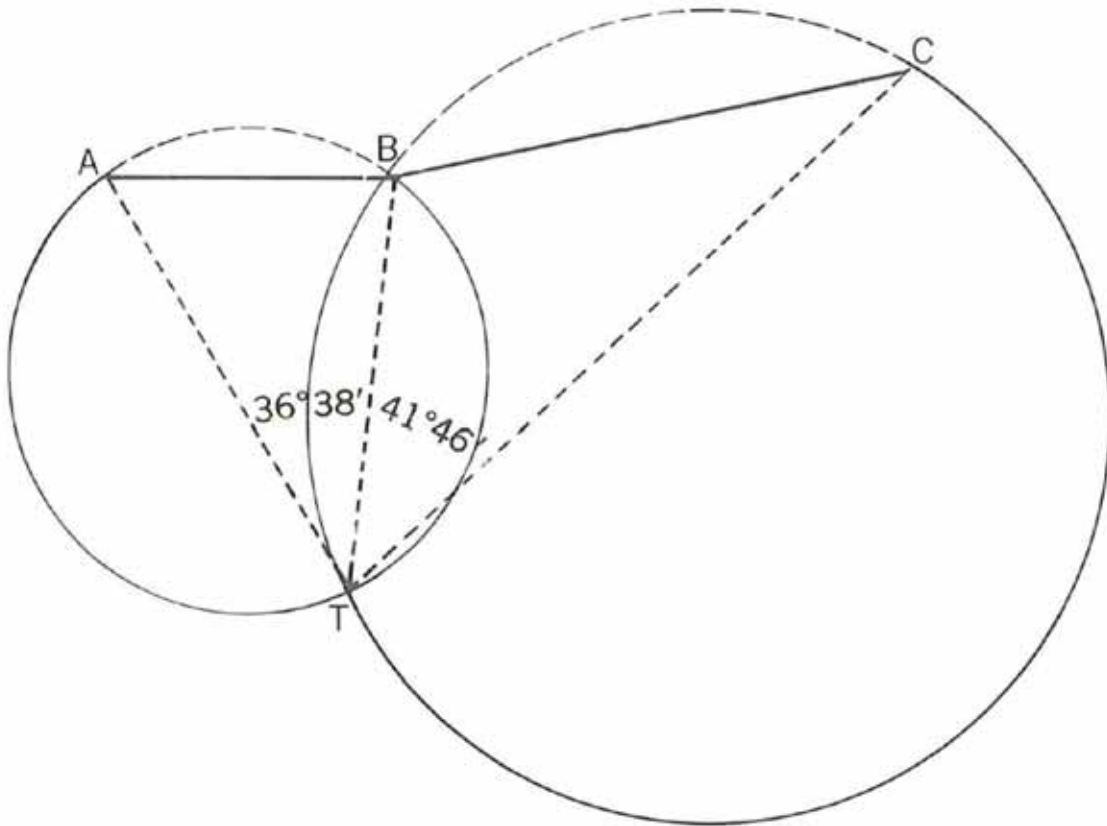

Figure 1101a. Solving the three-point problem.

protractor.

As shown in Figure 1102a, when the observed angle is 90° , the center of the circle of equal angle lies at the center of the baseline or at the foot of the perpendicular bisector of the baseline. When the observed angle is less than 90° , for example 40° , the center of the circle lies on the perpendicular bisector on the same side of the baseline as the observer. When the observed angle is $26^\circ 34'$, the center of the circle lies on the bisector at a distance from its foot equal to the distance between the two objects. When the observed angle is greater than 90° , the center of the circle lies on the perpendicular bisector on the side of the baseline opposite from the observer. The center for 100° is the same distance from the baseline as the center for 80° ; the center for 110° is the same distance as the center for 70° , etc. These facts can be used to construct a nomogram for finding the distances of circles of equal angle from the foot of the perpendicular for various angles.

From geometry the central angle subtended by a chord is twice the angle with its vertex on the circle and subtended by the same chord. Therefore, when the observed horizontal angle is 30° , the central angle subtended by the baseline is 60° . Or, the angle at the center of the circle between the perpendicular bisector and the line in the direction of one of the observed objects is equal to the observed angle, or 30° as

shown in Figure 1102c. The angle at the object between the baseline and the center of the circle on the bisector is 90° minus observed angle, or 60° .

1103. Split Fix

Occasions when a common charted object cannot be used in horizontal angle observations are rare. On these occasions the mariner must obtain what is called a **split fix** through observation of two pairs of charted objects, with no object being common. As with the three-point fix, the mariner will obtain two circles of equal angle, intersecting at two points. As shown in Figure 1103, one of these two intersections will fix the observer's position.

1104. Conning aid

Preconstructed circles of equal angle can be helpful in conning the vessel to a specific geographic position when fixing by horizontal angles. In one application, the vessel is conned to keep one angle constant, or nearly constant, in order to follow the circumference of the associated circle of equal angle to the desired position; the other angle is changing rapidly and is approaching the value for the second circle of equal angle passing through the desired position.

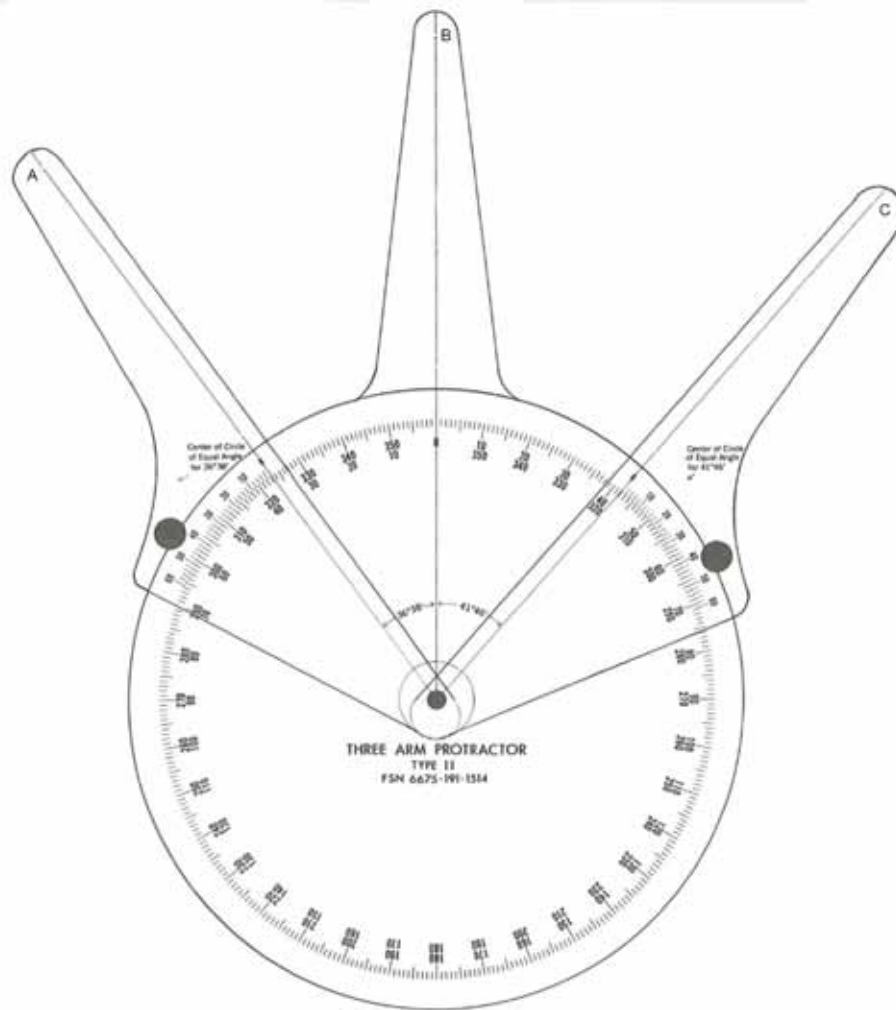

Figure 1101b. Use of the three-armed protractor.

1105. Strength of three-point fix

Although an experienced navigator can readily estimate the strength of a three-point fix, and is able to select the objects providing the strongest fix available quickly, others often have difficulty in visualizing the problem and may select a weak fix when strong ones are available. The following generally useful (but not infallible) rules apply to selection of charted objects to be observed:

1. The strongest fix is obtained when the observer is inside the triangle formed by the three objects. And in such case the fix is strongest where the three objects form an equilateral triangle (Figure 1105, view A), the observer is at the center, and the objects are close to the observer.

2. The fix is strong when the sum of the two angles equal to or greater than 180° and neither angle is less than 30° . The nearer the angles are equal to each other, the stronger is the fix (view B).

3. The fix is strong when the three objects lie in a

straight line and the center object is nearest the observer (view C).

4. The fix is strong when the center object lies between the observer and a line joining the other two, and the center object is nearest the observer (view D).

5. The fix is strong when two objects a considerable distance apart are in range and the angle to the third object is greater than 45° (view E).

6. Small angles should be avoided as they result in weak fixes in most cases and are difficult to plot. However, a strong fix is obtained when two objects are nearly in range and the nearest one is used as the common object. The small angle must be measured very accurately, and the position of the two objects in range must be very accurately plotted. Otherwise, large errors in position will result. Such fixes are strong only when the common object is nearest the observer. The fix will become very weak where the observer moves to a position where the distant object is the common object (view F).

7. A fix is strong when at least one of the angles chang-

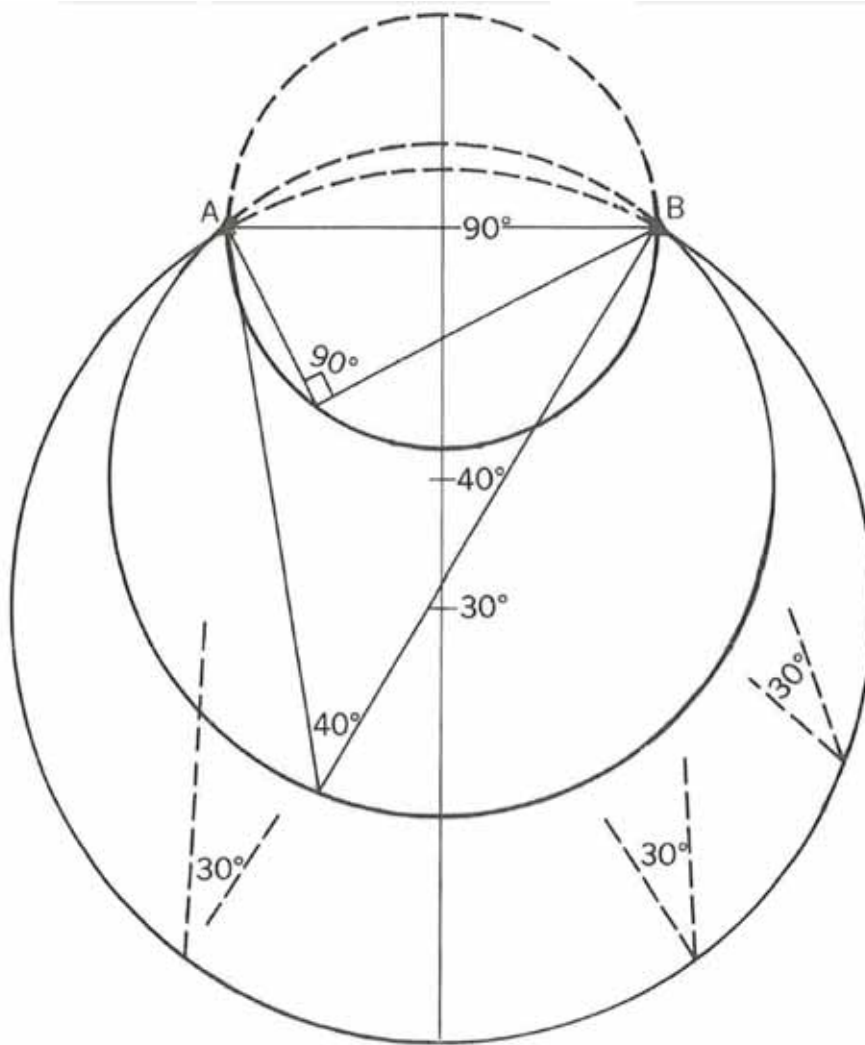

Figure 1102a. Circles of equal angle.

es rapidly as the vessel moves from one location to another.

8. The sum of the two angles should not be less than 50° ; better results are obtained when neither angle is less than 30° .

9. Do not observe an angle between objects of considerably different elevation. Indefinite objects such as tangents, hill-tops, and other poorly defined or located points should not be used. Take care to select prominent objects such as major lights, church spires, towers or buildings which are charted and are readily distinguished from surrounding objects.

Beginners should demonstrate the validity of the above rules by plotting examples of each and their opposites. It should be noted that a fix is strong if, in plotting, a slight movement of the center of the protractor moves the arms away from one or more of the stations, and is weak if such movement does not appreciably change the relation of the arms to the three points. An appreciation of the accuracy required in measuring angles can be obtained by changing

one angle about five minutes in arc in each example and noting the resulting shift in the plotted positions;

The **error of the three-point fix** will be due to:

1. error in measurement of the horizontal angles;
2. error resulting from observer and observed objects not lying in a horizontal plane;
3. instrument error; and
4. plotting error.

The magnitude of the error varies directly as the error in measurement, the distance of the common object from the observer, (D) and inversely as the sine function of the angle of cut (?). The magnitude of the error also depends upon the following ratios:

1. The distance to the object to the left of the observer divided by the distance from this object to the center object (r_1).
2. The distance to the object to the right of the observer divided by the distance from this object to the center object

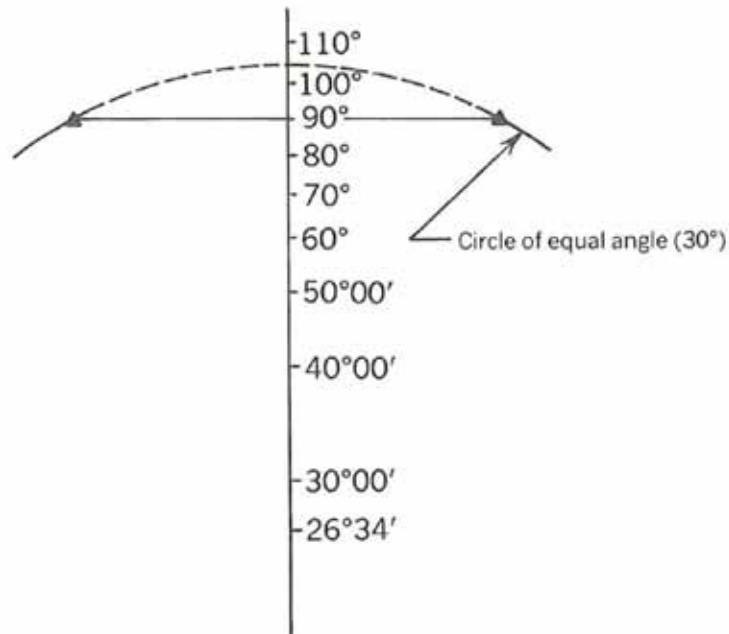

Figure 1102b. Graduated perpendicular bisector.

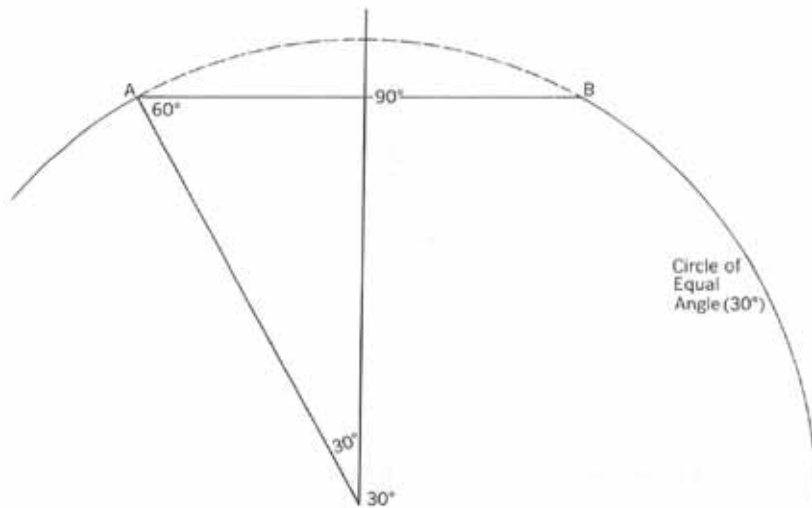

Figure 1102c. Circle of equal angle (30°).

(r_2).

Assuming that each horizontal angle has the same error (?), the magnitude of the error (E) is expressed in the formula

$$E = \frac{\alpha D}{\sin \theta} \sqrt{r_1^2 + r_2^2 + (2r_1)r_2 \cos \theta}$$

where error in measurement (?) is expressed in radians.

The magnitude of the error (E) is expressed in the formula

$$E = \frac{0.00029 \alpha D}{\sin \theta} \sqrt{r_1^2 + r_2^2 + (2r_1)r_2 \cos \theta}$$

where error in measurement (?) is expressed in minutes of arc.

To avoid mistakes in the identification of charted objects observed, either a check bearing or a check angle should be used to insure that the objects used in observation and plotting are the same.

1106. Avoiding the swinger

Avoid a selection of objects which will result in a “revolver” or “swinger”; that is, when the three objects observed on shore and the ship are all on, or near, the cir-

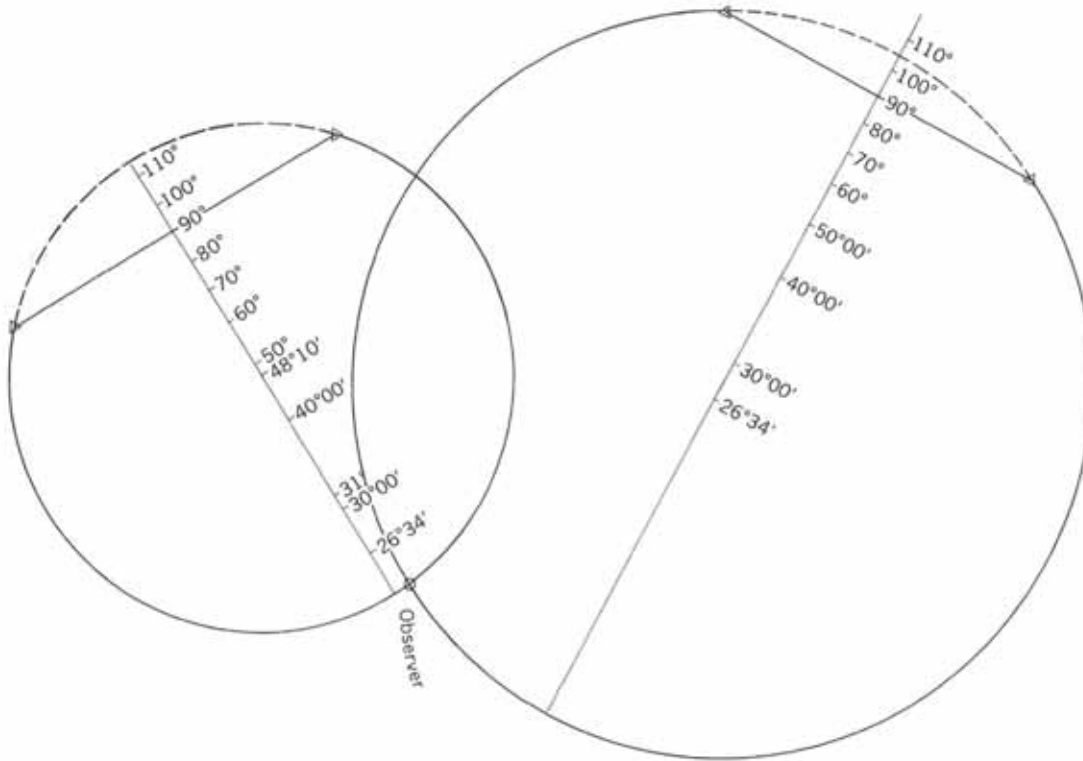

Figure 1103. Split fix.

cumference of a circle (Figure 1106). In such a case the ship's position is indeterminate by three-point fix.

If *bearings* as plotted are affected by unknown and uncorrected compass error, the bearing lines may intersect at a point when the objects observed ashore and the ship are all on, or near, the circumference of a circle.

1107. Cutting in uncharted objects

To cut in or locate on the chart uncharted objects, such as newly discovered offshore wrecks or objects ashore which may be useful for future observations, proceed as follows:

1. Fix successive positions of the ship or ship's boat by three-point fixes, i.e., by horizontal sextant angles. At each fix, simultaneously measure the sextant angle between one of the objects used in the fix and the object to be charted (Figure 1107b). For more accurate results, the craft from which the observations are made should be either lying to or proceeding slowly.

2. For best results, the angles should be measured simultaneously. If verification is undertaken, the angles observed should be interchanged among observers.

3. The fix positions should be selected carefully to give strong fixes, and so that the cuts to the object will provide a good intersection at the next station taken for observations. A minimum of three cuts should be taken.

An alternative procedure is to select observing positions so that the object to be charted will be in range with

one of the charted objects used to obtain the three-point fix (Figure 1107a). The charted objects should be selected to provide the best possible intersections at the position of the uncharted object.

1108. Horizontal and vertical danger angles

A vessel proceeding along a coast may be in safe water as long as it remains a minimum distance off the beach. This information may be provided by any means available. One method useful in avoiding particular dangers is the use of a **danger angle**. Refer to Figure 1108. A ship is proceeding along a coast on course line *AB*, and the captain wishes to remain outside a danger *D*. Prominent landmarks are located at *M* and *N*. A circle is drawn through *M* and *N* and tangent to the outer edge of the danger. If *X* is a point on this circle, angle *MXN* is the same as at any other point on the circle (except that part between *M* and *N*). Anywhere within the circle the angle is *larger* and anywhere outside the circle it is *smaller*. Therefore, any angle smaller than *MXN* indicates a safe position and any angle larger than *MXN* indicates possible danger. Angle *MXN* is therefore a maximum **horizontal danger angle**. A minimum horizontal danger angle is used when a vessel is to pass *inside* an off-lying danger, as at *D'* in Figure 1108. In this case the circle is drawn through *M* and *N* and tangent to the *inner* edge of the danger area. The angle is kept larger than *MYN*. If a vessel is to pass between two danger areas, as in Figure 1108, the horizontal angle should be kept smaller than *MXN* but

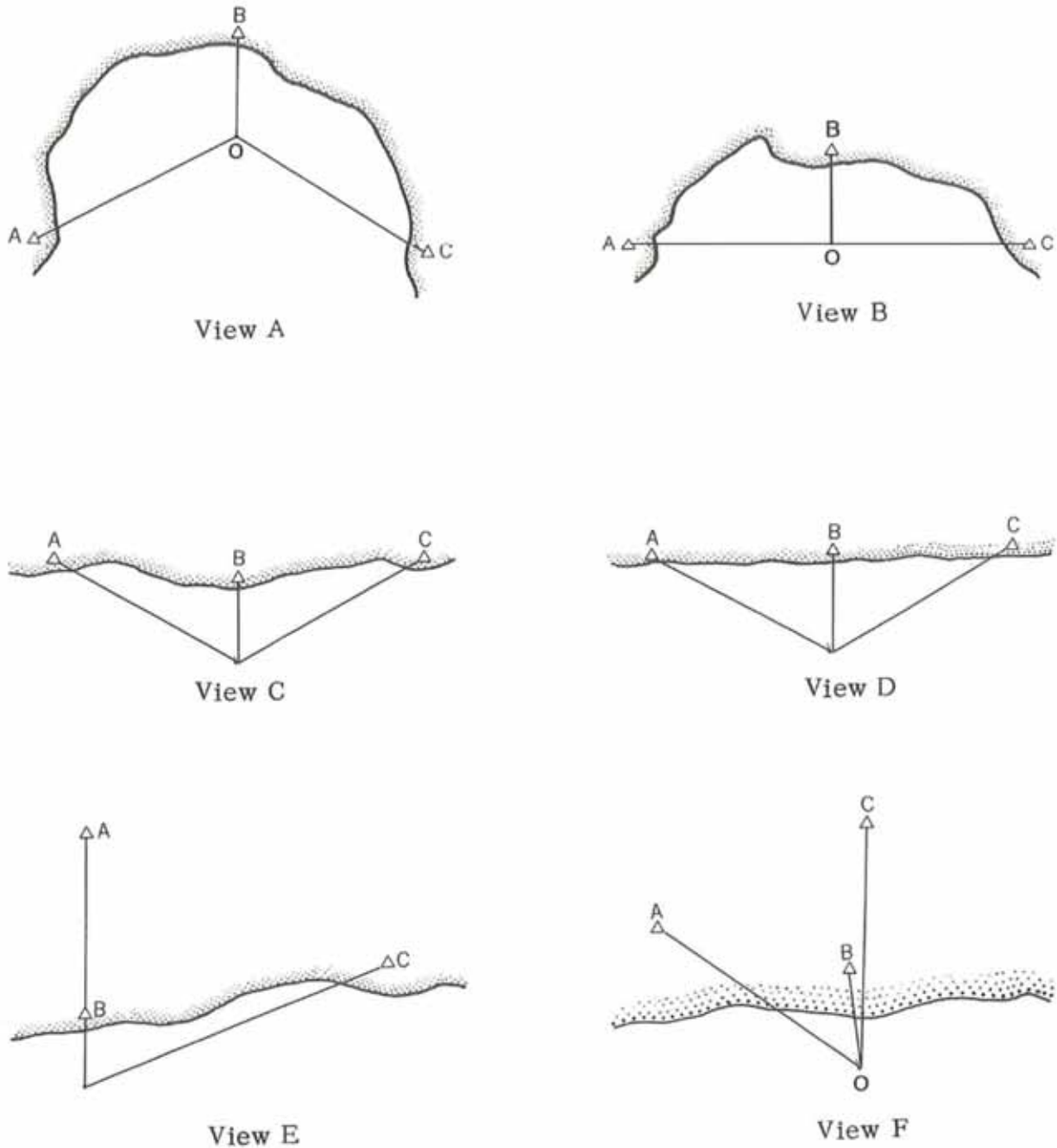

Figure 1105. Strengths of three-point fixes.

larger than *MYN*. The minimum danger angle is effective only while the vessel is inside the larger circle through *M* and *N*. Bearings on either landmark might be used to indicate the entering and leaving of the larger circle. A margin of safety can be provided by drawing the circles through points a short distance off the dangers. Any method of measuring the angles, or difference of bearing of *M* and *N*, can be used. Perhaps the most accurate is by horizontal sextant angle. If a single landmark of known height is available, similar procedure can be used with a **vertical danger angle** between top and bottom of the object. In this case the chart-

ed position of the object is used as the center of the circles.

1109. Distance by vertical angle

Table 16 (Distance by Vertical Angle) provides means for determining the distance of an object of known height above sea level. The vertical angle between the top of the object and the visible (sea) horizon (the sextant altitude) is measured and corrected for index error and dip only. If the visible horizon is not available as a reference, the angle should be measured to the bottom of the object, and dip short of the horizon (table. 15) used in

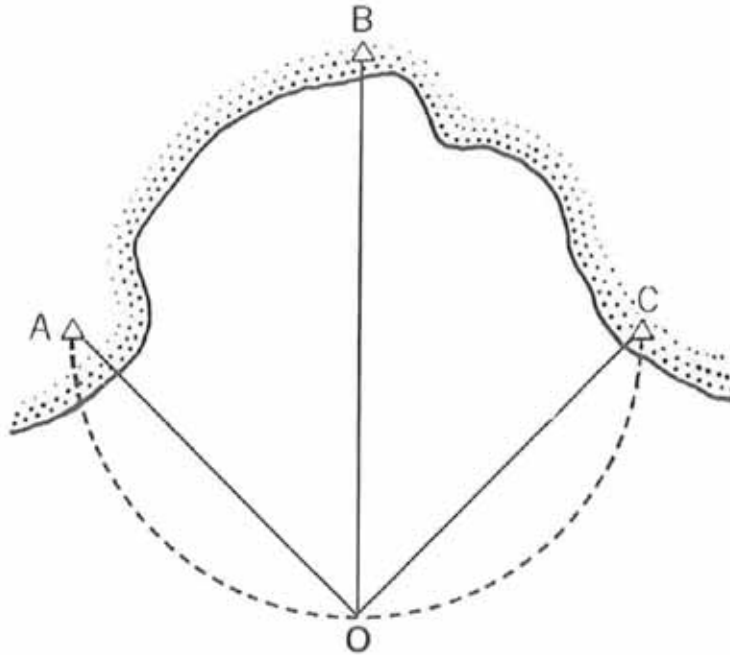

Figure 1106. Revolver or swinger.

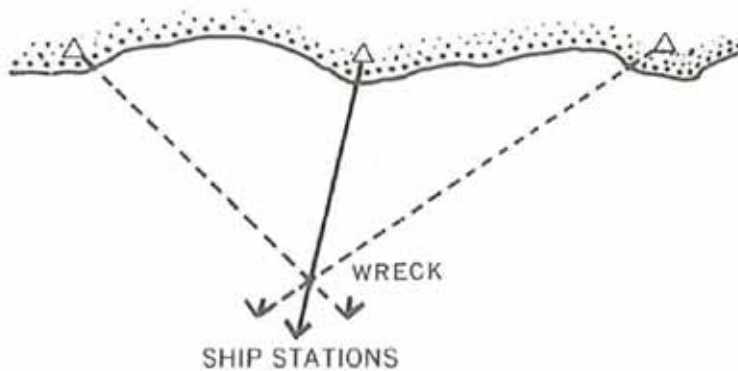

Figure 1107a. On range method.

place of the usual dip correction. This may require several approximations of distance by alternate entries of tables 16 and 15 until the same value is obtained twice. The table is entered with the difference in the height of the object and the height of eye of the observer, in feet, and the corrected vertical angle; and the distance in nautical miles is taken directly from the table. An error may be introduced if refraction differs from the standard value used in the computation of the table. See the Explanation of Tables section in Volume II for more details.

1110. Evaluation

As time and conditions permit, it behooves the navigator to use the sextant to evaluate the accuracy of navigation by other means in pilot waters. Such accuracy comparisons tend to provide navigators with better appreciation of the limitations of fixing by various methods in a given piloting situation.

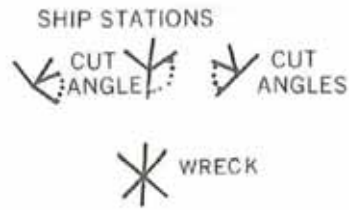

Figure 1107b. Cutting in uncharted objects.

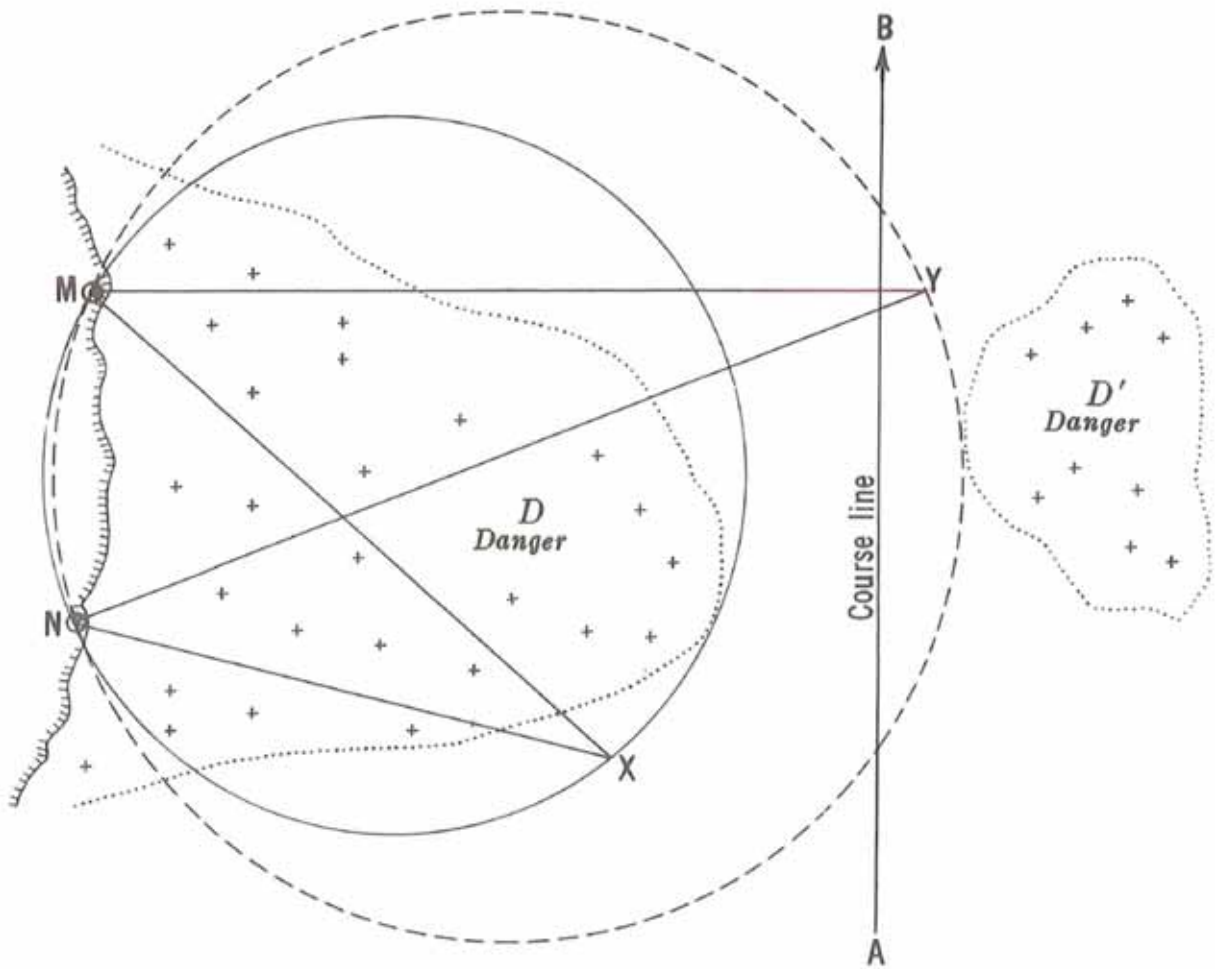

Figure 1108. Horizontal danger angles.

CHAPTER 12

THE SAILINGS

INTRODUCTION

1200. Introduction

Dead reckoning involves the determination of a present or future position by projecting the vessel's course and distance run from a known position. A closely related problem is that of finding the course and distance from one known point to another. For short distances, these problems are easily solved directly on charts, but for trans-oceanic distances, a purely mathematical solution is often a better method. Collectively, these methods are called **The Sailings**.

Navigational computer programs and calculators commonly contain algorithms for computing all of the problems of the sailings. This chapter discusses basic calculation methods and tabular solutions. Navigators can also refer to National Geospatial-Intelligence Agency (NGA) *Pub. 151, Distances Between Ports*, for distances along normal ocean routes. Pilot charts also offer some track and distance information.

Because most commonly used formulas for the sailings are based on rules of spherical trigonometry and assume a perfectly spherical Earth, there may be inherent errors in the calculated answers. Also, differences in rounding practices will result in slightly varying solutions. Errors of a few miles over distances of a few thousand miles can be expected. These will generally be much less than errors due to currents, steering error, and leeway.

To increase the accuracy of these calculations, one would have to take into account the oblateness of the Earth. Formulas exist which account for oblateness, reducing these errors to less than the length of the typical vessel using them, but far larger errors can be expected on any voyage of more than a few day's duration.

There are two types of Sailings: Great Circle and Rhumb Lines. Both will be described in detail in this chapter.

1201. Terms and Definitions

In solutions of the sailings, the following quantities are used:

1. **Arc min.** Minutes of arc; for example, 234 arc min is usually indicated as 234' in formulae.
2. **Course (Cn).** The vessel's true course, or a track-line's true course, as measured from 000°-360° T.

3. **Course Angle (C).** The angular direction measured clockwise or counterclockwise from 000° through 090° or 180°. The reference direction (north or south) will be the prefix and the direction of measurement (east or west) will be the suffix. The parameters and procedure for labeling the prefix and suffix differs with the type of sailing. C is normally expressed as N/S xxx° E/W and converted to true course by reading "the true course is xxx° E/W of N/S."

4. **Departure (p or Dep.).** The distance (in nautical miles) between two meridians at any given parallel of latitude; differentiated from DLo which is an angular measure of the same arc and does not change with latitude. Departure (p) between two meridians decreases with the cosine of the latitude as latitude increases. At the equator, departure is equal to DLo (in minutes). Departure becomes zero at the poles. Departure must be marked E or W depending on the direction it was measured. The relationship between departure and DLo is $p = (\cos L) DLo$.

5. **Difference of latitude (l or DLat or ΔL).** The shorter arc of any meridian between the parallels of two places, expressed in angular measure. The difference in latitude between L1 and L2, usually expressed in minutes of arc.

6. **Difference of longitude (DLo or Δ Long or Δλ).** The shorter arc of a parallel between the meridians of two places, expressed in angular measure. The difference in longitude between two points, usually expressed in minutes of arc; Differentiated from p (departure) which is the same arc measured in nautical miles. DLo will remain the same regardless of latitude. DLo_v is the difference in longitude between the point of departure and the great circle vertex. DLo_{vx} is the difference in longitude between the great circle vertex and a point on the great circle track.

7. **Distance (D or Dist.).** Distance in nautical miles (nm) of 6,076.1 feet or 1,852 meters. D_v is the great circle distance to the vertex from the point of departure. D_{vx} is the distance from the vertex to a

- point on the great circle track.
8. **Latitude (L).** The latitude of the point of departure is designated L_1 ; that of the destination, L_2 ; middle (mid) or mean latitude, L_m ; latitude of the vertex of a great circle, L_v ; and latitude of any point on a great circle, L_x .
 9. **Longitude (λ).** The longitude of the point of departure is designated λ_1 ; that of the point of arrival or the destination, λ_2 ; of the vertex of a great circle, λ_v ; and of any point on a great circle, λ_x .
 10. **Mean latitude (L_m).** Half the arithmetical sum of the latitudes of two places on the same side of the equator.
 11. **Meridional parts (M).** The meridional parts of the

point of departure are designated M_1 , and of the point of arrival or the destination, M_2 . Meridional Parts can be found in Table 6 in Volume 2 with the latitude as an entering value.

12. **Meridional difference (m).** The mathematical difference between the tabular values of M_2 and M_1 .
13. **Middle or mid latitude (L_m).** The latitude exactly mid-way between the point of departure and point of arrival latitudes. The latitude at which the arc length of the parallel separating the meridians passing through two specific points is exactly equal to the departure (p) in proceeding from one point to the other by mid-latitude sailing. The mean latitude is used when there is no practicable means of determining the middle latitude.

KINDS OF SAILINGS

1202. Great Circles

A **great circle** is the intersection of the surface of a sphere and a plane through the center of the sphere. It is the largest circle that can be drawn on the surface of the sphere and is the shortest distance, along the surface, between any two points on the sphere. Any two points are connected by only one great circle, unless the points are antipodal (180° apart), in which case an infinite number of great circles pass through them. Every great circle bisects every other great circle. Thus, except for the equator, every great circle lies half in the northern hemisphere and half in the southern hemisphere. Any two points 180° apart on a great circle have the same numerical latitude, but contrary names, and are 180° apart in longitude.

The point of greatest latitude on a great circle is called the **vertex**, and there is a vertex in each hemisphere, 180° apart. At the vertex, the great circle is tangent to a parallel of latitude and the direction along the great circle would be exactly due east or west. On each side of these vertices the direction changes progressively until the intersection with the equator is reached, 90° away, where the great circle crosses the equator at an angle equal to the latitude of the vertex. As the great circle crosses the equator, its change in direction reverses, again approaching east/west, which it reaches at the next vertex.

Great circle sailing involves the solution of courses, distances, and points along a great circle between two points. Great circle sailing takes advantage of the shorter distance along the great circle between two points, as compared to the longer rhumb line. The arc of the great circle between the points of departure and arrival is called the **great circle track**. The rhumb line appears the more direct route on a Mercator chart because of chart distortion. Along any intersecting meridian the great circle crosses at

a higher latitude than the rhumb line. Because the great circle crosses meridians at higher latitudes, where the distance between them is less, the great circle route is shorter than the rhumb line.

The savings in distance offered by a great circle route, as compared to a rhumb line track, increases as

1. the latitude increases (the farther from the equator the route is)
2. as the difference of latitude between the two points decreases (the more easterly/westerly the track), and
3. as the difference of longitude increases (the longer the route is). Of course any track that runs exactly due north or south, or lies along the equator is itself a great circle and would be coincident with the rhumb line track.

On a Mercator projection, a great circle appears as a sine curve, concave to the equator, extending equal distances on each side of the equator. The rhumb line connecting any two points of the great circle on the same side of the equator is a chord of the curve. If the two points are on opposite sides of the equator, the direction of curvature of the great circle relative to the rhumb line changes at the equator. The rhumb line and great circle may intersect each other, and if the points are equal distances on each side of the equator, the intersection takes place at the equator. Along any intersecting meridian, the great circle crosses at a higher latitude than the rhumb line. If the two points are on opposite sides of the equator, the direction of curvature of the great circle relative to the rhumb line changes at the equator.

Despite the constant course changes required to follow a great circle, if the great circle could be followed exactly,

the destination would always be dead ahead (on the sphere). Since a great circle (other than a meridian or the equator) is a curved line whose true direction changes continually, the navigator does not attempt to follow it exactly. Instead, a number of waypoints are selected along the great circle, rhumb lines are drawn between the waypoints, and the vessel is steered along these rhumb lines. The number of points to use is a matter of personal preference. A large number of points provides a closer approximation to the great circle, but requires more frequent course changes. As a general rule, 5° of longitude is a convenient length. This method does not provide legs of equal length, but under normal conditions, this is acceptable. Care must be taken to apply the correct variation and deviation to magnetic compass headings as the vessel changes location and heading along the great circle route.

The decision to use a great circle sailing depends upon several factors. The savings in distance should be worth the additional effort, and of course the great circle route cannot cross land, nor should it carry the vessel into dangerous waters. If a vessel finds herself considerably off the desired great circle track, it may be preferable to generate a new great circle route for the remainder of the voyage, rather than return to the original route.

1203. Altering a Great Circle Track to Avoid Obstructions

Usually, great circle tracks are followed from an offshore point of departure, near a sea buoy for example, to a similar offshore point of arrival. However, obstructions such as land, ice, or prohibited areas may make following the great circle for the entire voyage impossible. One may also alter a direct route in order to take advantage of favorable winds or currents. If the great circle route needs to be modified the navigator may follow the great circle to the obstruction then follow a rhumb line course (or several) until clear of the obstruction, and then follow a great circle to the destination. One could also sail great circle to a point near the obstruction and then a different great circle from that point to the destination. Another solution is to use a composite sailing.

1204. Rhumb Lines

A rhumb line makes the same angle with all meridians it crosses and appears as a straight line on a Mercator chart. The principal advantage of a rhumb line is that it maintains a constant true direction and a ship following the rhumb line between two places does not change its true course. It is adequate for most purposes of navigation, bearing lines (except long bearing lines such as are obtained by radio bearings), and course lines both being plotted on a Mercator chart as rhumb lines, except in high latitudes.

Rhumb line sailings account for the spherical nature of the path using various mathematical formulae, and will

yield different results for courses, distances and positions depending on the type of sailing used.

The types of rhumb line sailings are:

1. **Parallel sailing** is the interconversion of departure and difference of longitude when a vessel is proceeding due east or due west and thus sailing along a parallel of latitude.
2. **Plane sailing** solves problems involving a single course and distance, difference of latitude, and departure, in which the Earth is regarded as a plane surface. This method, therefore, provides solution for latitude of the point of arrival, but not for longitude of the arrival point. To calculate the longitude, the spherical sailings are necessary. Because of the assumption that the Earth is flat, plane sailing is not intended for distances of more than a few hundred miles.
3. **Mercator sailing** provides a mathematical solution of the plot as made on a Mercator chart. It is similar to plane sailing, but uses meridional difference and difference of longitude in place of difference of latitude and departure, respectively.
4. **Middle- (or mid-) latitude sailing** uses the mean latitude for converting departure to difference of longitude when the course is not due east or due west and it is assumed the course is steered at the mid latitude.
5. **Traverse sailing** combines the plane sailing solutions when there are two or more courses and determines the equivalent course and distance made good by a vessel steaming along a series of rhumb lines.
6. **Meridian sailing** describes a vessel is sailing due north or south along a meridian of longitude. No solutions are necessary because there is no departure or difference in longitude. Though course is constant, it actually is also a great circle sailing.

1205. Composite Sailing

A **composite sailing** (a combination of great circle and rhumb line tracks) is planned as a great circle route with rhumb line portions inserted as required to sail along a desired parallel of latitude, usually to avoid a navigational danger such as ice, land, or inclement weather. The composite track consists of a great circle from the point of departure tangent to a limiting parallel of latitude, a course line due east or west along the parallel of latitude, and a great circle tangent to the limiting latitude and to the destination.

Solution is made most easily by means of a great circle chart. Composite sailing only applies when the vertex lies between the departure and arrival points.

GREAT CIRCLE SAILING SOLUTIONS

1206. Great Circle Sailing by Chart

The graphic solution of great circle problems involves the use of gnomonic projection charts. NGA publishes several gnomonic projections covering the principal navigable waters of the world. On these great circle charts, any straight line is a great circle. Gnomonic charts however, are not conformal; therefore, the navigator cannot directly measure directions or distances as on a Mercator chart.

The usual method of using a gnomonic chart is to plot the route and pick points along the track every 5° of longitude using the latitude and longitude scales in the immediate vicinity of each point. These points are then transferred to a Mercator chart and connected by rhumb lines. The course and distance for each leg can then be measured on the Mercator chart, and the points entered as waypoints. See Figure 1206. A projection on which a straight line is approximately

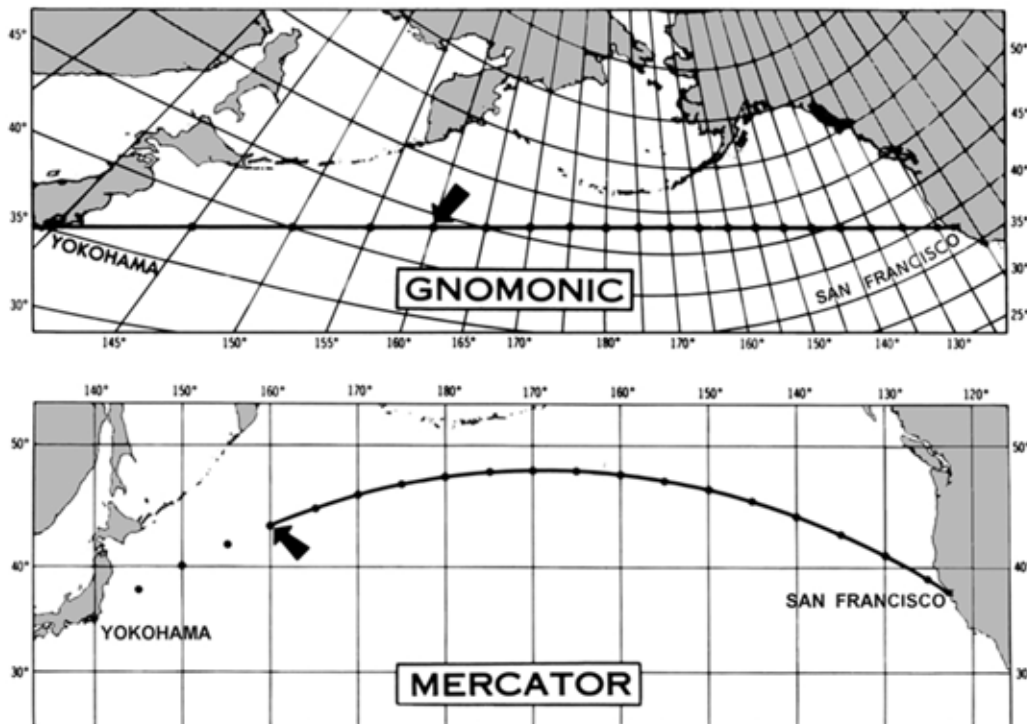

Figure 1206. Constructing a great circle track on a Mercator projection.

a great circle can be used in place of a gnomonic chart with negligible error. If the projection is conformal, such as a Lambert conformal chart, measurement of course and distance of each leg can be made directly on the chart.

1207. Great Circle Sailing by Sight Reduction Tables

Any method of solving a spherical triangle can be used for solving great circle sailing problems. The point of departure replaces the assumed position of the observer, the destination replaces the geographical position of the body, the difference of longitude replaces the meridian angle or local hour angle, the initial course angle replaces the azimuth angle, and the great circle distance replaces the zenith distance ($90^\circ - \text{altitude}$). See Figure 1207b. Therefore, any table of azimuths (if the entering values are meridian angle, declination, and latitude) can be used

for determining initial great circle course. Tables which solve for altitude, such as *Pub. No. 229*, can be used for determining great circle distance. The required distance is $90^\circ - \text{altitude}$. Explanation can be found on pages xx-xxii in the introductions section of *Pub. No. 229*. *Pub. No. 229* is available for download through the link found in Figure 1207a.



Figure 1207a. *Pub. No. 229*.

<https://msi.nga.mil/MSISiteContent/StaticFiles/NAV/Pubs/STRM/Pub229/Vol 2/Pub229Vol2.pdf>

For some inspection tables like those in *Pub. No. 229*, the given combination of L_1 , L_2 , and DLo may not be tabulated. In this case reverse the name of L_2 and use $180^\circ - DLo$ for entering the table. The required course angle is then 180° minus the tabulated azimuth, and distance is 90° plus the altitude. If neither combination can be found,

solution cannot be made by that method. By interchanging L_1 and L_2 , one can find the supplement of the final course angle.

Solution by table often provides a rapid approximate check, but accurate results usually require triple interpolation.

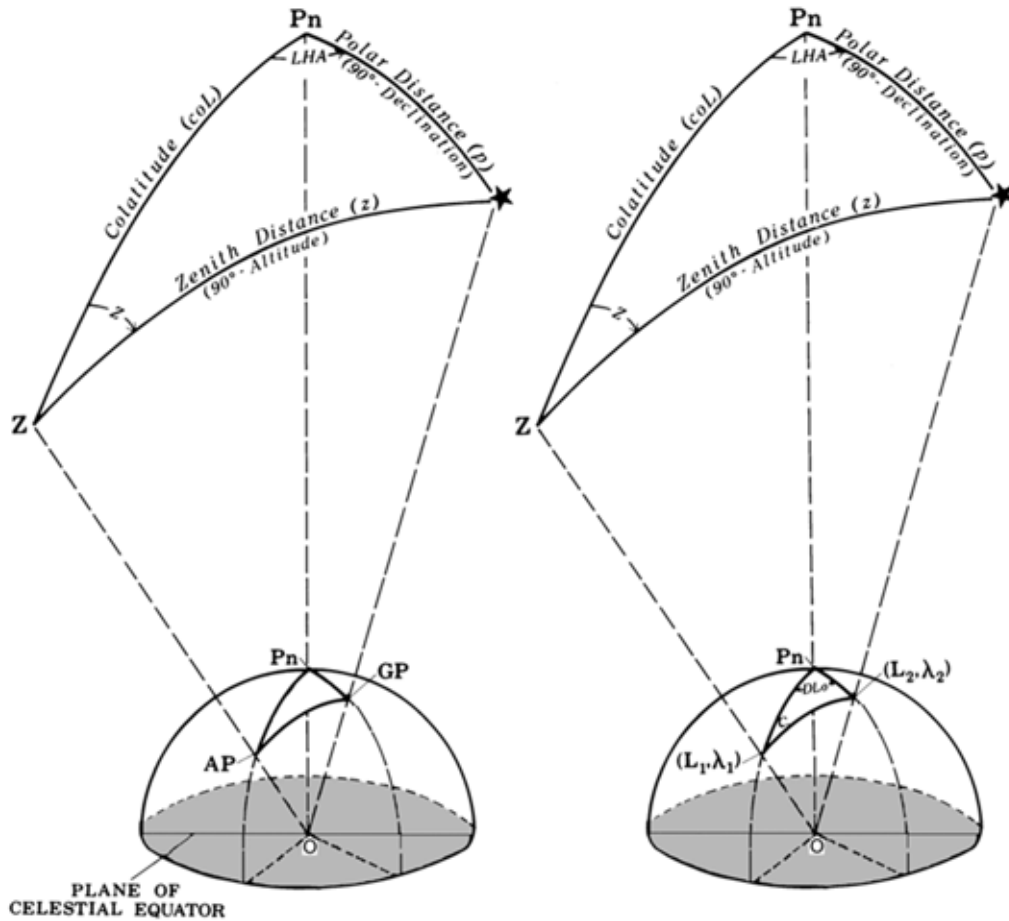

Figure 1207b. Adapting the astronomical triangle to the navigational triangle of great circle sailing.

Except for *Pub. No. 229*, inspection tables do not provide a solution for points along the great circle. *Pub. No. 229* provides solutions for these points only if interpolation is not required.

By entering *Pub. No. 229* with the latitude of the point of departure as latitude, latitude of destination as declination, and difference of longitude as LHA, the tabular altitude and azimuth angle may be extracted and converted to great circle distance and course. As in sight reduction, the tables are entered according to whether the name of the latitude of the point of departure is the same as or contrary to the name of the latitude of the destination (declination). If the values correspond to those of a celestial body above the celestial horizon, 90° minus the arc of the tabular

altitude becomes the distance; the tabular azimuth angle becomes the initial great circle course angle. If the respondents correspond to those of a celestial body below the celestial horizon (meaning the Contrary/Same (C/S) line has been crossed), the arc of the tabular altitude plus 90° becomes the distance, and the supplement of the tabular azimuth angle becomes the initial great circle course angle.

When the C/S line is crossed in either direction, the altitude becomes negative and the body lies below the celestial horizon. For example: If the tables are entered with the LHA (DLo) at the bottom of a right-hand page and declination (L_2) such that the respondents lie above the C/S line, the C/S line has been crossed. Then the distance is 90° plus the tabular altitude and the initial course angle is the

supplement of the tabular azimuth angle. Similarly, if the tables are entered with the LHA (DLo) at the top of a right-hand page and the respondents are found below the C/S line, the distance is 90° plus the tabular altitude and the initial course angle is the supplement of the tabular azimuth angle. If the tables are entered with the LHA (DLo) at the bottom of a right-hand page and the name of L_2 is contrary to L_1 , the respondents are found in the column for L_1 on the facing page. In this case, the C/S line has been crossed and the distance is 90° plus the tabular altitude, and the initial course angle is the supplement of the tabular azimuth angle.

The tabular azimuth angle, or its supplement, is prefixed N or S for the latitude of the point of departure (L_1) and suffixed E or W depending upon the destination being east or west of the point of departure (DLo).

If all entering arguments are integral degrees, the distance and course angle are obtained directly from the tables without interpolation. If the latitude of the destination is non-integral, interpolation for the additional minutes of latitude is done as in correcting altitude for declination increment. If the latitude of departure (L_1) or difference of longitude (DLo) is non-integral, the additional interpolation is done graphically.

Since the latitude of destination becomes the declination entry, and all declinations appear on every page, the great circle solution can always be extracted from the volume which covers the latitude of the point of departure.

Example 1: (L_1 and L_2 on same side of equator) - Using Pub. No. 229, Vol 2, find the distance and initial great circle course from lat. $22^\circ S$, long. $116^\circ E$ to lat. $20^\circ S$, long. $31^\circ E$.

Solution: Refer to Figure 1207b. The point of departure (L $22^\circ S$, λ $116^\circ E$) replaces the AP of the observer; The destination (L $20^\circ S$, λ $31^\circ E$) replaces the GP of the celestial body; The difference of longitude (DLo 085°) replaces local hour angle (LHA) of the body.

Enter Pub. No. 229, Volume 2 with L 22° (Same Name), LHA 085° , and declination S 20° (page 172). The respondents fall above the C/S line, and thus correspond to a celestial body above the celestial horizon. Therefore, 90° minus the tabular altitude becomes the distance ($90^\circ - 11^\circ 46.5' = 78^\circ 13.5' = 4,693.5$ nm); the tabular azimuth angle (Z), here S $073.0^\circ W$, becomes the initial great circle course angle, prefixed S for the latitude of the point of departure (L_1) and suffixed W due to the destination being west of the point of departure (DLo).

Answer:

$$D = 4,693.5 \text{ nautical miles (nm)}$$

$$C = S 073.0^\circ W \therefore C_n = 253.0^\circ T$$

Example 2: (L_1 and L_2 on opposite sides of the equator) - Using Pub. No. 229, Vol 2, find the distance and initial

great circle course from lat. $28^\circ N$, long. $122^\circ W$ to lat. $24^\circ S$, long. $151^\circ E$.

Solution: Refer to Figure 1207b. The point of departure (L $28^\circ N$, λ $122^\circ W$) replaces the AP of the observer; The destination (L $24^\circ S$, λ $151^\circ E$) replaces the GP of the celestial body; The difference of longitude (DLo 087°) replaces local hour angle (LHA) of the body.

Enter Pub. No. 229 Volume 2 with L 28° (Contrary Name), LHA 087° , and declination S 24° . To find corresponding entries requires the C/S line be crossed. Thus, the respondents correspond to those of a celestial body below the celestial horizon. Therefore, the tabular altitude plus 90° becomes the distance ($08^\circ 33.2' + 90^\circ = 098^\circ 33.2' = 5,913.2$ nm); the supplement of tabular azimuth angle (Z) becomes the initial great circle course angle, prefixed N for the latitude of the point of departure (L_1) and suffixed W since the destination is west of the point of departure (DLo) ($180^\circ - 67.3^\circ = 112.7^\circ$). Note that the data is extracted from across the CS Line from the entering argument (LHA 87°), indicating that the corresponding celestial body would be below the celestial horizon.

Answer:

$$D = 5,913.2 \text{ nm}$$

$$C = N112.7^\circ \therefore C_n = 247.3^\circ T$$

1208. Great Circle Sailing by Computation

In Figure 1208, 1 is the point of departure, 2 the destination, P the pole nearer 1, 1-X-V-2 the great circle through 1 and 2, V the vertex, and X any point on the great circle. The arcs P1, PX, PV, and P2 are the colatitudes of points 1, X, V, and 2, respectively. If 1 and 2 are on opposite sides of the equator, P2 is $90^\circ + L_2$. The length of arc 1-2 is the great circle distance between 1 and 2. Arcs 1-2, P1, and P2 form a spherical triangle. The angle at 1 is the initial great circle course from 1 to 2, that at 2 the supplement of the final great circle course (or the initial course from 2 to 1), and that at P the DLo between 1 and 2.

Great circle sailing by computation usually involves solving for the initial great circle course, the distance, latitude/longitude (and sometimes the distance) of the vertex, and the latitude and longitude of various points (X) on the great circle. The computation for initial course and the distance involves solution of an oblique spherical triangle, and any method of solving such a triangle can be used. If 2 is the geographical position (GP) of a celestial body (the point at which the body is at the zenith), this triangle is solved in celestial navigation, except that $90^\circ - D$ (the altitude) is desired instead of D. The solution for the vertex and any point X usually involves the solution of right spherical triangles.

There are many formulae appropriate for great circle

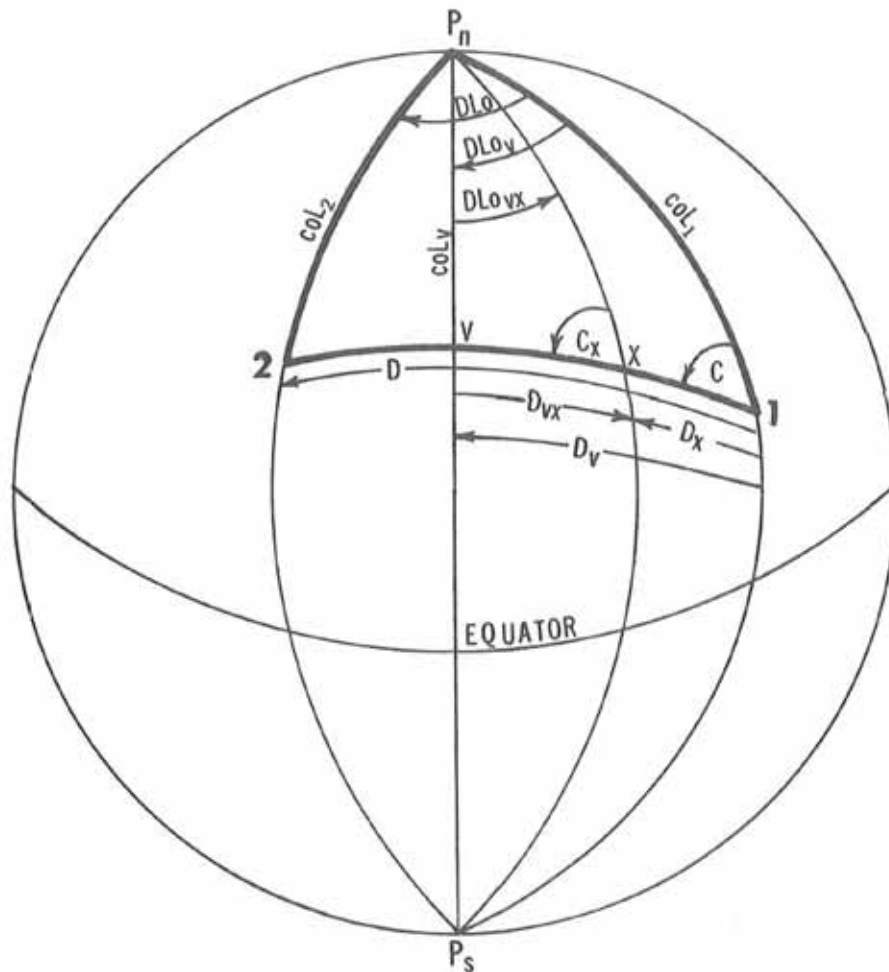

Figure 1208. The navigation triangle of great-circle sailing.

solutions. When solving by computation, angular measurements must be in decimal format to at least three decimal places. Rounding and varying levels of precision will generate differences in results. **Formulae intended for calculator-based solutions are provided below:**

$$\cos D = (\sin L_1)(\sin L_2) + (\cos L_1)(\cos L_2)(\cos DLo)$$

- If crossing the equator, make L_2 negative

\tan Initial Course Angle (C) =

$$\tan(C) = \sin DLo / (\cos L_1)(\tan L_2) - (\sin L_1)(\cos DLo)$$

- Make L_2 negative if crossing the equator

- If C is negative, add 180°

- Prefix C by L_1 and suffix by DLo

\cos Final Course Angle (C) =

$$\cos(C) = \sin L_1 - (\cos D)(\sin L_2) / (\sin D)(\cos L_2)$$

- Make L_1 negative if crossing the equator

- Label final course angle contrary to L_2 and same DLo

Example 1 (L_1 and L_2 on same side of equator): Using the calculations method, find the distance and initial great circle course from $L 22^\circ S, \lambda 116^\circ E$ to $20^\circ S, \lambda 031^\circ E$.

Solution:

$$DLo = 085^\circ W'ly$$

$$\cos D = (\sin 22^\circ)(\sin 20^\circ) + (\cos 22^\circ)(\cos 20^\circ)(\cos 85^\circ)$$

$$\cos D = 0.204$$

$$D = 78.23^\circ = 4,693.8 \text{ nm}$$

$$\tan C = (\sin 85^\circ) / (\cos 22^\circ)(\tan 20^\circ) - (\sin 22^\circ)(\cos 85^\circ)$$

$$\tan C = 3.2694$$

$$\therefore C = S 72.99^\circ W \approx S 73^\circ W \therefore C_n = 253^\circ T$$

Answer:

$$D = 4,693.8 \text{ nm}$$

$$C_n = 253^\circ T$$

Example 2 (L_1 and L_2 on opposite sides of equator): Us-

ing the calculation method, find the distance and initial great circle course from $L 28^\circ N$, $\lambda 122^\circ W$ to $L 24^\circ S$, $\lambda 151^\circ E$.

Solution:

$$DLo = 087^\circ W'ly$$

$$\cos D = (\sin 28^\circ)(\sin -24^\circ) + (\cos 28^\circ)(\cos -24^\circ)(\cos 87^\circ)$$

$$\cos D = -.1487$$

$$D = 98.55^\circ = 5,913.1 \text{ nm}$$

$$\tan C = (\sin 87^\circ) / (\cos 28^\circ)(\tan -24^\circ) - (\sin 28^\circ)(\cos 87^\circ)$$

$$\tan C = -2.391$$

$$C = -67.3^\circ \text{ (if } C \text{ is negative, subtract from } 180^\circ) \therefore C = N$$

$$112.7^\circ W \therefore Cn = 247.3^\circ T$$

Answer:

$$D = 5,913.1 \text{ nm}$$

$$Cn = 247.3^\circ T$$

Example 3 (Final Course Angle): Using the calculation method, find the final course from $L 22^\circ S$, $\lambda 116^\circ E$ to $L 20^\circ S$, $\lambda 031^\circ E$. Additional, $D = 4,693.8 \text{ nm} = 78.23^\circ$.

Solution:

$$\cos \text{Final Course Angle } (C) = \sin L1 - (\cos D)(\sin L2) / (\sin D)(\cos L2)$$

$$\cos C = \sin 22^\circ - (\cos 78.23^\circ)(\sin 20^\circ) / (\sin 78.23^\circ)(\cos 20^\circ) = .2988$$

$$\therefore C = N 72.6^\circ W \therefore Cn = 287.4^\circ T$$

Answer:

$$Cn = 287.4^\circ T$$

1209. Points Along the Great Circle

Since the great circle is continuously changing direction as one proceeds along it, no attempt is usually made to follow it exactly. Instead, a number of points along the route are selected (either at specific distances, arc, or DLo from the vertex) and rhumb lines are followed between these selected points. Since for short distances a great circle and a rhumb line almost coincide, this practice effectively yields the savings of the great circle route. This is normally done on a great circle chart. Points can also be determined by formulae or the sight reduction tables. In most cases, the position of the vertex must be known.

Keep in mind that DLo_v and D_v of the closest vertex are never more than 90° . When L_1 and L_2 are on opposite sides of the equator, the farther vertex, 180° away, may be the better vertex to use in the solution for points along the great circle track if it is nearer the mid-point of the route. Navigators may decide to select points along the great circle track by either selecting **equal distances** or **equal DLo** measures from the vertex.

1. Select **equal DLo** intervals each side of the vertex,

and solve for the corresponding latitudes. This method provides for shorter legs in higher latitudes and longer legs in lower latitudes. If DLo_v is less than 90° , L_x has the same name as L_v . If DLo_{vx} is greater than 90° , then L_x is of contrary name. Since the great circle is a symmetrical curve about the vertex, any DLo can be applied to λ_v in both directions (E and W) to find two points of equal latitude. However, if whole degrees of λ_x are desired, different E and W intervals are needed unless λ_v is a whole degree or exact half degree. The formula for the DLo technique is:

$$\tan L_x = (\cos DLo_{vx}) (\tan L_v).$$

2. Select **equal distances** from the vertex and solve for corresponding positions along the great circle route. In these formulae, distance must be expressed as degrees. If distance is greater than 90° (5,400 nm), L_x is of contrary name to L_v , and DLo_{vx} is greater than 90° . The formulae for the equal distance technique are:

$$\sin L_x = (\sin L_v) (\cos D_{vx})$$

$$\sin DLo_{vx} = (\sin D_{vx}) / (\cos L_x).$$

Example 1: Determine points along the great circle track 12° on either side of the vertex, with $L_v 41^\circ 21.2' N$, $\lambda_v 160^\circ 34.4' W$.

Solution:

$$\tan L_x = (\cos DLo_{vx} \text{Solution}) (\tan L_v)$$

$$\tan L_x = (\cos 12^\circ) (\tan 41.3533^\circ) = (.9781) (.8802) = .8609$$

Answer:

$$L_x = 40.7252^\circ$$

$$= 40^\circ 43.5' N, \lambda_x 172^\circ 34.4' W \text{ and } \lambda_x 148^\circ 34.4' W$$

Example 2: Determine points along the great circle track 300 nm and 600 nm from the vertex, with $L_v 41^\circ 21.2' N$, $\lambda_v 160^\circ 34.4' W$.

Solution (300 nm):

$$\sin L_x = (\sin L_v) (\cos D_{vx})$$

$$\sin L_x = (\sin 41.3533^\circ) (\cos 5^\circ) = (.6607) (.9962) = .6582$$

$$\therefore L_x = 41.1627^\circ = 41^\circ 09.8' N$$

$$\sin DLo_{vx} = (\sin D_{vx}) / (\cos L_x)$$

$$\sin DLo_{vx} = (\sin 5^\circ) / (\cos 41.1627^\circ) = (.0872) / (.7528) = .1158$$

$$\therefore DLo_{vx} = 6.6498^\circ = 6^\circ 38.9'$$

Answer:

$$L_x 41^\circ 09.8' N, \lambda_x 167^\circ 13.3' W \text{ (west of vertex)}$$

and

$$\lambda_x 153^\circ 55.5' W \text{ (east of vertex).}$$

Solution (600 nm):

$$\sin L_x = (\sin 41.3533^\circ) (\cos 10^\circ) = (.6607) (.9848) = .6507$$

$$\therefore L_x = 40.5944^\circ = 40^\circ 35.7' N$$

$$\sin DLo_{vx} = (\sin D_{vx}) / (\cos L_x)$$

$$\sin DLo_{vx} = (\sin 10^\circ) / (\cos 40.5944^\circ)$$

$$= (.1736) / (.7593) = .2286$$

$$\therefore DLo_{vx} = 13.2147^\circ = 13^\circ 12.9'$$

Answer:

$$L_x = 40.5944^\circ$$

$$= 40^\circ 35.7' N, \lambda_x 173^\circ 47.3' W \text{ (west of vertex)}$$

and

$$\lambda_x 147^\circ 21.5' W \text{ (east of vertex).}$$

Points along the great circle route may also be determined by using **sight reduction tables**, if the latitude of the point of departure and the initial great circle course angle are integral degrees, points along the great circle are found by entering the sight reduction tables with the latitude of departure as the latitude argument (always Same Name), the initial great circle course angle as the LHA argument, and 90° minus distance to a point on the great circle as the declination argument. The latitude of the point on the great circle and the difference of longitude between that point and the point of departure are the tabular altitude and azimuth angle, respectively. If, however, the respondents are extracted from across the C/S line, the tabular altitude corresponds to a latitude on the side of the equator opposite from that of the point of departure; the tabular azimuth angle is the supplement of the difference of longitude.

Example 1: Find a number of points along the great circle from $L 28^\circ N, \lambda 125^\circ W$ when the initial great circle course angle is $N 111^\circ W$ using sight reduction tables.

Solution: Entering the tables in Pub. 229 with $L 28^\circ$ (Same Name), LHA 111° (found at the bottom of page 323), and with successive declinations of $85^\circ, 80^\circ, 75^\circ, 40^\circ$, etc., the latitudes and differences in longitude from $125^\circ W$ are found as tabular altitudes and azimuth angles respectively:

Answer:

<i>D (nm)</i>	300	600	900	3000
<i>D (arc)</i>	5°	10°	15°	50°
<i>Dec.</i>	85°	80°	75°	40°
<i>Hc = Lat.</i>	$26^\circ 06.6' N$	$24^\circ 02.5' N$	$21^\circ 48.8' N$	$03^\circ 24.2' N$

Table 1209a

<i>Dep.</i>	$125^\circ W$	$125^\circ W$	$125^\circ W$	$125^\circ W$
<i>(Z) = DLo</i>	5.2°	10.2°	15.1°	45.8°
<i>Long.</i>	$130.2^\circ W$	$135.2^\circ W$	$140.1^\circ W$	$170.8^\circ W$

Table 1209a

Example 2: Find a number of points along the great circle track from $L 28^\circ N, \lambda 125^\circ W$ when the initial great circle course angle (C) is $N 069^\circ W$ using sight reduction tables.

Solution: Enter the tables with $L 28^\circ$ (Same Name), LHA 069° (found on page 322), and with successive declinations as shown. Find the latitudes and differences of longitude from $125^\circ W$ as tabular altitudes and azimuth angles, respectively:

Answer:

<i>D (nm)</i>	300	600	900	6600
<i>D (arc)</i>	5°	10°	15°	110°
<i>Dec.</i>	85°	80°	75°	20°
<i>Hc = Lat.</i>	$29^\circ 41.2' N$	$31^\circ 09.0' N$	$32^\circ 22.1' N$	$27^\circ 15.1' N$
<i>Dep.</i>	$125^\circ W$	$125^\circ W$	$125^\circ W$	$125^\circ W$
<i>(Z) = DLo</i>	5.4°	10.9°	16.6°	80.7°
<i>Long.</i>	$130.4^\circ W$	$135.9^\circ W$	$141.6^\circ W$	$154.3^\circ W$

Table 1209b

Example 3: Find a number of points along the great circle from $L 28^\circ N, \lambda 125^\circ W$ when the initial great circle course angle is $N 111^\circ W$ ($Cn = 249^\circ T$, which is SW'ly) by calculation. Determine points $5^\circ, 10^\circ$ and 15° from the point of departure.

Solution:

First, find the vertex: $\cos L_v = (\cos L_1) (\sin C)$

$$\cos L_v = (\cos 28^\circ) (\sin 111^\circ)$$

$$= (.8829) (.9336) = .8243$$

$$\therefore L_v = 34.4824^\circ = 34^\circ 29.9' N$$

$$\sin DLo_v = (\cos C) / (\sin L_v)$$

$$= (\cos 111^\circ) / (\sin 34.4824^\circ) = (-.3584) / (.5662)$$

$$\sin DLo_v = -.6329 \therefore DLo_v = -39.2644^\circ \text{ (E'ly)}$$

$$= 39^\circ 15.9' \text{ E'ly}$$

position of vertex: $L 34^\circ 29.9' N, \lambda 085^\circ 44.1' W$

Now find points along the track:

$$DLo_{vx} \text{ for } 5^\circ = 130^\circ W - 085.7356^\circ = 44.2644^\circ$$

$$DLo_{vx} \text{ for } 10^\circ = 135^\circ W - 085.7356^\circ = 49.2644^\circ$$

$$DLo_{vx} \text{ for } 15^\circ = 140^\circ W - 085.7356^\circ = 54.2644^\circ$$

$$\tan L_x = (\cos DLo_{vx}) (\tan L_v)$$

Answer:

$$\tan L_{5^{\circ}} = (\cos 44.2644^{\circ}) (\tan 34.4824^{\circ})$$

$$= (.7161) (.6868) = .4918$$

$$\therefore L_{5^{\circ}} = 26.1879^{\circ} = 26^{\circ} 11.3' N$$

$$\tan L_{10^{\circ}} = (\cos 49.2644^{\circ}) (\tan 34.4824^{\circ})$$

$$= (.6526) (.6868) = .4482$$

$$\therefore L_{10^{\circ}} = 24.1419^{\circ} = 24^{\circ} 08.5' N$$

$$\tan L_{15^{\circ}} = (\cos 54.2644^{\circ}) (\tan 34.4824^{\circ})$$

$$= (.5840) (.6868) = .4011$$

$$\therefore L_{15^{\circ}} = 21.8557^{\circ} = 21^{\circ} 51.3' N.$$

1210. Direction at Various Points Along the Great Circle Track

To determine direction at any point along the great circle route, the following formulae may be used, but unless L_2 is of the same name and equal to or greater than L_1 , it leaves doubt as to whether C is less or greater than 90° . The formulae are:

$$\sin C = (\sin DLo) (\cos L_2) / (\sin D), \text{ and}$$

$$\cos C = (\sin L_v) (\sin DLo_v)$$

if the location of the vertex is known.

1211. Finding the Vertex

The vertex will always be equal or greater than L_1 or L_2 . If C is less than 90° , the nearer vertex is toward L_2 . If C is greater than 90° the vertex is in the opposite direction. Since every great circle circumscribes the entire globe, there is a vertex in each hemisphere. A vertex may be either embedded within the vessel's great circle route, or may be beyond the vessel's intended route and fall either ahead of or behind the intended track. The vertex nearer L_1 has the same name as L_1 .

Using *Pub. No. 229* to find the approximate position of the vertex of a great circle track provides a rapid check on the solution by computation. This approximate solution is also useful for voyage planning purposes.

Using the procedures for finding points along the great circle, inspect the column of data for the latitude of the point of departure and find the maximum value of tabular altitude. This maximum tabular altitude and the tabular azimuth angle correspond to the latitude of the vertex and the difference of longitude of the vertex and the point of departure. The vertex can also be calculated (here, C is initial course angle):

Latitude of the vertex

$$\cos L_v = (\cos L_1) (\sin C)$$

(name L_v same as L_1)

Difference in λ from departure point to the vertex

$$\sin DLo_{1v} = (\cos C) / (\sin L_v)$$

(If initial course is $< 90^{\circ}$ vertex is ahead of the vessel and DLo and DLo_v have the same name. If initial course is $> 90^{\circ}$, DLo and DLo_v have opposite names and the vertex is behind the vessel).

Distance to the vertex

$$\sin D_v = (\cos L_1) (\sin DLo_v)$$

Longitude when crossing the equator is determined by applying 90° to the longitude of the vertex in the direction of DLo . The longitude of crossing must lie between the points of departure and arrival in the direction of DLo from the vertex.

Example 1: Find the vertex of the great circle track from lat. $28^{\circ}N$, long. $125^{\circ}W$ when the initial great circle course angle (C) is $N 069^{\circ}W$.

Solution: Enter *Pub. No. 229* with $L 28^{\circ}$ (Same Name), $LHA 069^{\circ}$ (found on page 322), and inspect the column for $L 28^{\circ}$ to find the maximum tabular altitude. Maximum altitude (H_c) of $34^{\circ} 28.9'$ occurs when declination is 56° . The distance of the vertex from the point of departure can be calculated as $90^{\circ} - Dec$. Thus, $90^{\circ} - 56^{\circ} = 34^{\circ} = 2,040$ nm. The corresponding tabular azimuth angle (Z) is 039.3° . Therefore, the difference of longitude between vertex and point of departure is 39.3° .

Answer:

Distance of the vertex from the point of departure = 2,040 nm

Latitude of vertex = $34^{\circ} 28.9' N$

Longitude of vertex = $125^{\circ} W + 39.3^{\circ} W = 164.3^{\circ} W$.

Solution by calculation:

$$\cos L_v = (\cos L_1) (\sin C) = (\cos 28^{\circ}) (\sin 69^{\circ})$$

$$= (.8829) (.9336) = .8243$$

$$\therefore L_v = 34.4824^{\circ} = 34^{\circ} 28.9' N$$

$$\sin DLo_v = (\cos C) / (\sin L_v)$$

$$= (\cos 69^{\circ}) / (\sin 34.4824^{\circ})$$

$$= (.3584) / (.5662) = .6329$$

$$\therefore DLo_v = 39.2644^{\circ} = 39^{\circ} 15.9'$$

Answer:

Latitude of vertex = $34^{\circ} 28.9' N$

Longitude of vertex = $125^{\circ} + 39.2644^{\circ} = 164^{\circ} 15.9' W$.

1212. Altering a Great Circle Track to Avoid Obstructions

Land, ice, or severe weather, or other operational constraints may prevent the use of great circle sailing for some or all of one's route. One of the principal advantages of the solution by great circle chart is that any hazards become immediately apparent. The pilot charts are particularly useful in this regard. Often a relatively short run by rhumb line is sufficient to reach a point from which the great circle track can be followed. Where a choice is possible, the rhumb line selected should conform as nearly as practicable to the direct great circle.

If the great circle route passes too near a navigational hazard, it may be necessary to follow a great circle to the vicinity of the hazard, one or more rhumb lines along the edge of the hazard, and another great circle to the destination. Another possible solution is the use of composite sailing; still another is the use of two great circles, one from the point of departure to a point near the maximum latitude of unobstructed water and the second from that point to the destination.

1213. Composite Sailing

When the great circle would carry a vessel to a higher latitude than desired, a modification of great circle sailing called **composite sailing** may be used to good advantage. The composite track consists of a great circle from the point of departure and tangent to the limiting parallel, a course line along the parallel, and then a great circle tangent to the limiting parallel and through to the destination.

Solution of composite sailing problems is most easily made with a great circle chart. For this solution, draw lines from the point of departure and the destination, tangent to the limiting parallel. Then measure the coordinates of various selected points along the composite track and transfer them to a Mercator chart, as in great circle sailing.

Composite sailing problems can also be solved by computation, using the equation:

$$\cos DLo_{vx} = \tan L_x \cot L_v$$

The point of departure and the destination are used successively as point X. Solve the two great circles at each end of the limiting parallel, and use parallel sailing along the limiting parallel. Since both great circles have vertices at the same parallel, which is the limiting latitude, computation for C, D, and DLo_{vx} can be made by considering them parts of the same great circle with L_1 , L_2 , and L_v as given and $DLo = DLo_{v1} + DLo_{v2}$. The total distance is the sum of the great circle and parallel distances.

Example 1: Determine the longitude at which a limiting latitude of $47^\circ N$ will be reached when using a composite sailing from $L 36^\circ 57.7' N$, $\lambda 075^\circ 42.2' W$ to $L 45^\circ 39.1' N$, $\lambda 001^\circ 29.8' W$. Also determine the longitude when the limiting latitude should be left and the great circle track resumed.

Solution (for limiting latitude):

$$L_1 36^\circ 57.7' N = 36.9617^\circ$$

$$L_2 45^\circ 39.1' N = 45.6517^\circ$$

$$L_v = 47^\circ N$$

$$\cos DLo_{vx} = (\tan L_x) / (\tan L_v)$$

$$\cos DLo_{v1} = (\tan 36.9617) / (\tan 47)$$

$$= (.7525) / (1.0724) = .7017$$

$$\therefore DLo_{v1} = 45.4364^\circ = 45^\circ 26.2' E'ly$$

Answer:

$$\lambda_1 = 075^\circ 42.2' W + 45^\circ 26.2' E'ly$$

$$= 030^\circ 16.0' W \text{ (start rhumb line along } L 47^\circ N \text{).}$$

Solution (for λ_2):

$$\cos DLo_{v2} = (\tan 45.6517) / (\tan 47)$$

$$= (1.0230) / (1.0724) = .9539$$

$$\therefore DLo_{v2} = 17.4651^\circ = 17^\circ 27.9' W'ly$$

Answer:

$$\lambda_2 = 001^\circ 29.8' W + 17^\circ 27.9' W'ly$$

$$= 018^\circ 57.5' W \text{ (end rhumb line along } L 47^\circ N \text{).}$$

TRAVERSE TABLES

1214. Using Traverse Tables

Traverse tables can be used in the solution of any of the sailings except great circle and composite. They consist of the tabulation of the solutions of plane right triangles. Because the solutions are for integral values of the course angle and the distance, interpolation for intermediate values may be required. Through appropriate interchanges of the headings of the columns, solutions for other than plane

sailing can be made. For the solution of the plane right triangle, any value N in the distance (Dist.) column is the hypotenuse; the value opposite in the difference of latitude (D. Lat.) column is the product of N multiplied by the cosine of the acute angle; and the other number opposite in the departure (Dep.) column is the product of N and the sine of the acute angle. Or, the number in the D. Lat. column is the value of the adjacent side, and the number in the Dep. column is the value of the side opposite the acute angle.

Hence, if the acute angle is the course angle, the adjacent side in the D. Lat. column is meridional difference (m); the opposite side in the Dep. column is DLo. If the acute angle is the mid-latitude of the formula $p = DLo \cos L_m$, then DLo is any value N in the Dist. column, and the departure is the value $N (\cos L_m)$ in the D. Lat. column.

The examples below clarify the use of the traverse tables for plane, traverse, parallel, mid-latitude, and Mercator sailings.

1215. Plane Sailing

In plane sailing the figure formed by the meridian through the point of departure, the parallel through the point of arrival, and the course line is considered a plane right triangle. This is illustrated in Figure 1215a. P_1 and P_2 are the points of departure and arrival, respectively. The course angle and the three sides are as labeled. From this triangle:

$$\cos C = \frac{l}{D} \quad \sin C = \frac{p}{D} \quad \tan C = \frac{p}{l}$$

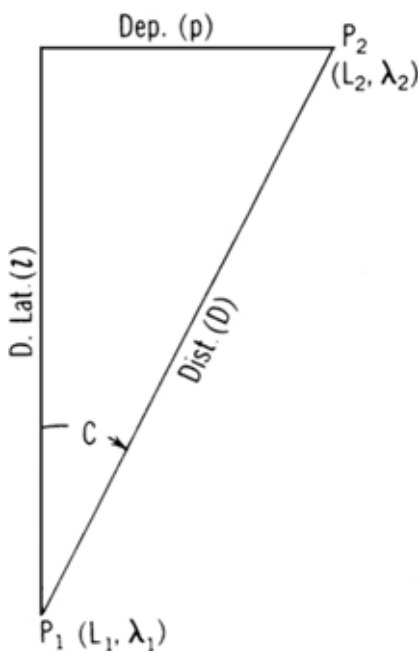

Figure 1215a. The plane sailing triangle.

From the first two of these formulas the following relationships can be derived:

$$l = D \cos C \quad D = l \sec C \quad p = D \sin C$$

Label l as N or S, and p as E or W, to aid in identification of the quadrant of the course. Solutions by calculations and traverse tables are illustrated in the following examples:

Example 1: A vessel steams 188.0 nm on course 005°T.

Required: (1) Difference of latitude (l) and departure (p) by computation and (2) Difference of latitude (l) and departure (p) by traverse table.

(1) - Solution by computation:

Difference of latitude (l) by computation:

$$l = D (\cos C)$$

$$l = 188.0 \text{ nm} (\cos 5^\circ) = 188.0 (.9962) = 187.2856$$

$$l = 187.3' N$$

$$l = 3^\circ 07.3' N$$

Departure (p) by computation:

$$p = D (\sin C)$$

$$p = 188.0 (\sin 5^\circ) = 188.0 (.0872) = 16.3936$$

$$p = 16.4 \text{ nm}$$

Answer:

$$l = 3^\circ 07.3' N$$

$$p = 16.4 \text{ nm E}$$

(2) - Solution by traverse tables: See Figure 1215b. Enter the traverse table and find course 005° at the top of the page. Using the column headings at the top of the table, opposite 188 in the Dist. column extract D. Lat. (l) 187.3 and Dep. (p) 16.4 nm.

Answer:

$$l = 187.3' N = 3^\circ 07.3' N$$

$$p = 16.4 \text{ nm E}$$

Example 2: A ship has steamed 136.0 nm north and 203.0 nm west.

Required: (1) Course and distance by computation and (2) Course and distance by traverse table.

(1) - Solution by computation:

Course by computation

$$\tan C = p / l \therefore C = \arctan p / l$$

$$C = \arctan (203.0 / 136.0) = \arctan 1.4926$$

$$C = N 56.18^\circ W \quad N 56^\circ W$$

$$C_n \approx 304^\circ T$$

Draw the course vectors to determine the correct course. In this case the vessel has gone north 136 nm and west 203 nm. The course, therefore, is northwesterly and must have been between 270° and 360°.

Distance by computation:

$$D = l / (\cos C)$$

$$D = (136) / (\cos 56.18^\circ)$$

$$D = (136) / (.5566) = 244.34$$

$$D = 244.3 \text{ nm}$$

$\frac{355^\circ}{185^\circ} \frac{005^\circ}{175^\circ}$			TABLE 4									$\frac{355^\circ}{185^\circ} \frac{005^\circ}{175^\circ}$											
Traverse 5° Table																							
Dist.	D. Lat.	Dep.	Dist.	D. Lat.	Dep.	Dist.	D. Lat.	Dep.	Dist.	D. Lat.	Dep.	Dist.	D. Lat.	Dep.									
1	1.0	0.1	61	60.8	5.3	121	120.5	10.5	181	180.3	15.8	241	240.1	21.0									
2	2.0	0.2	62	61.8	5.4	22	121.5	10.6	82	181.3	15.9	42	241.1	21.1									
3	3.0	0.3	63	62.8	5.5	23	122.5	10.7	83	182.3	15.9	43	242.1	21.2									
4	4.0	0.3	64	63.8	5.6	24	123.5	10.8	84	183.3	16.0	44	243.1	21.3									
5	5.0	0.4	65	64.8	5.7	25	124.5	10.9	85	184.3	16.1	45	244.1	21.4									
6	6.0	0.5	66	65.7	5.8	26	125.5	11.0	86	185.3	16.2	46	245.1	21.4									
7	7.0	0.6	67	66.7	5.8	27	126.5	11.1	87	186.3	16.3	47	246.1	21.5									
8	8.0	0.7	68	67.7	5.9	28	127.5	11.2	88	187.3	16.4	48	247.1	21.6									
9	9.0	0.8	69	68.7	6.0	29	128.5	11.2	89	188.3	16.5	49	248.1	21.7									
10	10.0	0.9	70	69.7	6.1	30	129.5	11.3	90	189.3	16.6	50	249.0	21.8									
<hr/>																							
60	59.8	5.2	20	119.5	10.5	80	179.3	15.7	40	239.1	20.9	300	298.9	26.1									
Dist.	Dep.	D. Lat.	Dist.	Dep.	D. Lat.	Dist.	Dep.	D. Lat.	Dist.	Dep.	D. Lat.	Dist.	Dep.	D. Lat.									
$\frac{275^\circ}{265^\circ} \frac{085^\circ}{095^\circ}$			85°									<table border="1" style="width: 100%; border-collapse: collapse; text-align: center;"> <tr> <td>Dist.</td><td>D. Lat.</td><td>Dep.</td> </tr> <tr> <td>N.</td><td>N x Cos.</td><td>N x Sin.</td> </tr> <tr> <td>Hypotenuse</td><td>Side Adj.</td><td>Side Opp.</td> </tr> </table>			Dist.	D. Lat.	Dep.	N.	N x Cos.	N x Sin.	Hypotenuse	Side Adj.	Side Opp.
Dist.	D. Lat.	Dep.																					
N.	N x Cos.	N x Sin.																					
Hypotenuse	Side Adj.	Side Opp.																					

Figure 1215b. Extract from Table 4.

Answer:

$C = 304^\circ T$
 $D = 244.3 \text{ nm}$

(2) - Solution by traverse table: See Figure 1215c. Enter

the table and find 136 and 203 beside each other in the columns labeled D. Lat. and Dep., respectively. This occurs most nearly on the page for course angle 56° . Therefore, the course is $304^\circ T$. Interpolating for intermediate values, the corresponding number in the Dist. column is 244.3 nm

$\frac{326^\circ}{214^\circ} \frac{034^\circ}{146^\circ}$			TABLE 4									$\frac{326^\circ}{214^\circ} \frac{034^\circ}{146^\circ}$											
Traverse 34° Table																							
Dist.	D. Lat.	Dep.	Dist.	D. Lat.	Dep.	Dist.	D. Lat.	Dep.	Dist.	D. Lat.	Dep.	Dist.	D. Lat.	Dep.									
1	0.8	0.6	61	50.6	34.1	121	100.3	67.7	181	150.1	101.2	241	199.8	134.8									
2	1.7	1.1	62	51.4	34.7	22	101.1	68.2	82	150.9	101.8	42	200.6	135.3									
3	2.5	1.7	63	52.2	35.2	23	102.0	68.8	83	151.7	102.3	43	201.5	135.9									
4	3.3	2.2	64	53.1	35.8	24	102.8	69.3	84	152.5	102.9	44	202.3	136.4									
5	4.1	2.8	65	53.9	36.3	25	103.6	69.9	85	153.4	103.5	45	203.1	137.0									
<hr/>																							
60	49.7	33.6	20	99.5	67.1	80	149.2	100.7	40	199.0	134.2	300	248.7	167.8									
Dist.	Dep.	D. Lat.	Dist.	Dep.	D. Lat.	Dist.	Dep.	D. Lat.	Dist.	Dep.	D. Lat.	Dist.	Dep.	D. Lat.									
$\frac{304^\circ}{236^\circ} \frac{056^\circ}{124^\circ}$			56°									<table border="1" style="width: 100%; border-collapse: collapse; text-align: center;"> <tr> <td>Dist.</td><td>D. Lat.</td><td>Dep.</td> </tr> <tr> <td>N.</td><td>N x Cos.</td><td>N x Sin.</td> </tr> <tr> <td>Hypotenuse</td><td>Side Adj.</td><td>Side Opp.</td> </tr> </table>			Dist.	D. Lat.	Dep.	N.	N x Cos.	N x Sin.	Hypotenuse	Side Adj.	Side Opp.
Dist.	D. Lat.	Dep.																					
N.	N x Cos.	N x Sin.																					
Hypotenuse	Side Adj.	Side Opp.																					

Figure 1215c. Extract from Table 4.

Answer:

$$C = 304^\circ T$$

$$D = 244.3 \text{ nm}$$

1216. Traverse Sailing

A **traverse** is a series of courses or a track consisting of a number of course lines, such as might result from a sailing vessel tacking on various courses, or a vessel with operational needs requiring legs of various courses and distances. **Traverse sailing** is the finding of a single equivalent course and distance.

Though the problem can be solved graphically on a chart, traverse tables provide a mathematical solution. The distance to the north or south and to the east or west on each course is tabulated, the algebraic sum of difference of latitude and departure is found, and is then converted to course and distance.

If the effect of an estimated current is to be considered, the set is treated as an additional course, and the drift times the number of hours involved should be used as the distance. If direction and distance from some point, such as a lighthouse, other than the point of departure is desired, the bearing from the selected position to the point of departure is used as the first course and the distance between these points as the first distance.

Example: A ship steams as follows: course 158° , distance 15.5 nm; course 135° , distance 33.7 nm; course 259° , distance 16.1 nm; course 293° , distance 39.0 nm; course 169° , distance 40.4 nm.

Required: Equivalent single (1) course and (2) distance.

Solution: Solve each leg as a plane sailing and tabulate each solution as follows: For course 158° , extract the values for D. Lat. and Dep. opposite 155 in the Dist. column. Then, divide the values by 10 and round them off to the nearest tenth. Repeat the procedure for each leg.

Course	Dist. (nm)	N (nm)	S (nm)	S (nm)	W (nm)
158°	15.5		14.4	5.8	
135°	33.7		23.8	23.8	
259°	16.1		3.1		15.8
293°	39.0	15.2			35.9
169°	40.4		39.7	7.7	
Subtotals.		15.2	81.0	37.3	51.7
			-15.2		-37.3
Total			65.8S		14.4W

Table 1216a

Thus, the latitude difference is S 65.8 nm and the departure is W 14.4 nm. **Convert this to a course and distance** using the formulas discussed for plane sailings, above.

$$l = 65.8 \text{ S and } p = 14.4 \text{ W}$$

$$\tan C = p / l = 14.4 / 65.8 = .2188$$

$$\therefore C = S 12.3^\circ W$$

$$\therefore C_n = 192.3^\circ T$$

$$D = l / \cos C$$

$$= 65.8 / \cos 12.3^\circ$$

$$= 65.8 / .9770 = 67.3 \text{ nm}$$

Answer:

$$C_n = 192.3^\circ T$$

$$D = 67.3 \text{ nm}$$

1217. Parallel Sailing

Parallel sailing consists of the interconversion of departure and difference of longitude. It is the simplest form of spherical sailing and is used when a vessel is sailing due east or west. The formulas for these transformations are:

$$DLo = p \sec L \quad p = DLo \cos L$$

Example 1: The DR latitude of a ship on course 090° is $49^\circ 30' N$. The ship steams on this course until the longitude changes $3^\circ 30'$.

Required: The departure by (1) computation and (2) traverse table.

Solution:

(1) Solution by computation:

$$DLo = p / (\cos L) \therefore p = (DLo) (\cos L)$$

$$DLo = 3^\circ 30' = 210'$$

$$p = (210') (\cos 49.5^\circ) = 136.4 \text{ nm}$$

(2) Solution by traverse table: See Figure 1217a. Enter the traverse tables with latitude as course angle and substitute DLo as the heading of the Dist. column and Dep. as the heading of the D. Lat. column. Since the table is computed for integral degrees of course angle (or latitude), the tabulations in the pages for 49° and 50° must be interpolated for the intermediate value ($49^\circ 30'$). The departure for latitude 49° and DLo 210' is 137.8 nm. The departure for latitude 50° and DLo 210' is 135.0 nm. Interpolating for the intermediate latitude, the departure is 136.4 nm

Answer:

$$p = 136.4 \text{ nm.}$$

$\frac{319^\circ}{221^\circ} \frac{041^\circ}{139^\circ}$			TABLE 4									$\frac{319^\circ}{221^\circ} \frac{041^\circ}{139^\circ}$											
Traverse												41°			Table								
Dist.	D. Lat.	Dep.	Dist.	D. Lat.	Dep.	Dist.	D. Lat.	Dep.	Dist.	D. Lat.	Dep.	Dist.	D. Lat.	Dep.									
21	15.8	13.8	81	61.1	53.1	141	106.4	92.5	201	151.7	131.9	261	197.0	171.2									
22	16.6	14.4	82	61.9	53.8	42	107.2	93.2	02	152.5	132.5	62	197.7	171.9									
23	17.4	15.1	83	62.6	54.5	43	107.9	93.8	03	153.2	133.2	63	198.5	172.5									
24	18.1	15.7	84	63.4	55.1	44	108.7	94.5	04	154.0	133.8	64	199.2	173.2									
25	18.9	16.4	85	64.2	55.8	45	109.4	95.1	05	154.7	134.5	65	200.0	173.9									
26	19.6	17.1	86	64.9	56.4	46	110.2	95.8	06	155.5	135.1	66	200.8	174.5									
27	20.4	17.7	87	65.7	57.1	47	110.9	96.4	07	156.2	135.8	67	201.5	175.2									
28	21.1	18.4	88	66.4	57.7	48	111.7	97.1	08	157.0	136.5	68	202.3	175.8									
29	21.9	19.0	89	67.2	58.4	49	112.5	97.8	09	157.7	137.1	69	203.0	176.5									
30	22.6	19.7	90	67.9	59.0	50	113.2	98.4	10	158.5	137.8	70	203.8	177.1									
Dist.	Dep.	D. Lat.	Dist.	Dep.	D. Lat.	Dist.	Dep.	D. Lat.	Dist.	Dep.	D. Lat.	Dist.	Dep.	D. Lat.									
$\frac{311^\circ}{229^\circ} \frac{049^\circ}{131^\circ}$			49°									<table border="1" style="width: 100%; border-collapse: collapse; text-align: center;"> <tr><th>Dist.</th><th>D. Lat.</th><th>Dep.</th></tr> <tr><td>D Lo</td><td>Dep.</td><td></td></tr> <tr><td></td><td>m</td><td>D Lo</td></tr> </table>			Dist.	D. Lat.	Dep.	D Lo	Dep.			m	D Lo
Dist.	D. Lat.	Dep.																					
D Lo	Dep.																						
	m	D Lo																					

Figure 1217a. Extract from Table 4.

Example 2: The DR latitude of a ship on course 270° is L 38° 15' S. The ship steams on this course for a distance of 215.5 nm.

Answer:

DLo = 4° 34.4' W

Required: The change in longitude by (1) computation and (2) traverse table.

(2) Solution by traverse table: See Figure 1217b. Enter the traverse tables with latitude as course angle and substitute DLo as the heading of the Dist. column and Dep. as the heading of the D. Lat. column. As the table is computed for integral degrees of course angle (or latitude), the tabulations in the pages for 38° and 39° must be interpolated for the minutes of latitude. Corresponding to Dep. 215.5 nm in the former is DLo 273.5', and in the latter DLo 277.3'. Interpolating for minutes of latitude, the DLo is 274.4' W.

Solution:

(1) Solution by computation:

$p = 215.5'$

$DLo = (215.5') / (\cos 38.25^\circ)$

$DLo = (215.5') / (0.7853) = 274.4'$

$DLo = 274.4' W = 4^\circ 34.4' W$

$\frac{322^\circ}{218^\circ} \frac{038^\circ}{142^\circ}$			TABLE 4									$\frac{322^\circ}{218^\circ} \frac{038^\circ}{142^\circ}$											
Traverse												38°			Table								
Dist.	D. Lat.	Dep.	Dist.	D. Lat.	Dep.	Dist.	D. Lat.	Dep.	Dist.	D. Lat.	Dep.	Dist.	D. Lat.	Dep.									
31	24.4	19.1	91	71.7	56.0	151	119.0	93.0	211	166.3	129.9	271	213.6	166.8									
32	25.2	19.7	92	72.5	56.6	52	119.8	93.6	12	167.1	130.5	72	214.3	167.5									
33	26.0	20.3	93	73.3	57.3	53	120.6	94.2	13	167.8	131.1	73	215.1	168.1									
34	26.8	20.9	94	74.1	57.9	54	121.4	94.8	14	168.6	131.8	74	215.9	168.7									
35	27.6	21.5	95	74.9	58.5	55	122.1	95.4	15	169.4	132.4	75	216.7	169.3									
												<table border="1" style="width: 100%; border-collapse: collapse; text-align: center;"> <tr><th>Dist.</th><th>D. Lat.</th><th>Dep.</th></tr> <tr><td>D Lo</td><td>Dep.</td><td></td></tr> <tr><td></td><td>m</td><td>D Lo</td></tr> </table>			Dist.	D. Lat.	Dep.	D Lo	Dep.			m	D Lo
Dist.	D. Lat.	Dep.																					
D Lo	Dep.																						
	m	D Lo																					

Figure 1217b. Extracts from Table 4.

TABLE 4																													
321°			039°			Traverse						39°			Table			321°			039°								
219°			141°									219°			141°														
Dist.	D. Lat.	Dep.	Dist.	D. Lat.	Dep.	Dist.	D. Lat.	Dep.	Dist.	D. Lat.	Dep.	Dist.	D. Lat.	Dep.	Dist.	D. Lat.	Dep.	Dist.	D. Lat.	Dep.									
35	27.2	22.0	95	73.8	59.8	55	120.5	97.5	15	167.1	135.3	75	213.7	173.1	36	28.0	22.7	96	74.6	60.4	56	121.2	98.2	16	167.9	135.9	76	214.5	173.7
37	28.8	23.3	97	75.4	61.0	57	122.0	98.8	17	168.6	136.6	77	215.3	174.3	38	29.5	23.9	98	76.2	61.7	58	122.8	99.4	18	169.4	137.2	78	216.0	175.0
39	30.3	24.5	99	76.9	62.3	59	123.6	100.1	19	170.2	137.8	79	216.8	175.6															

Dist.	D. Lat.	Dep.
D Lo	Dep.	
	m	D Lo

Figure 1217b. Extracts from Table 4.

Answer:

$$DLo = 4^\circ 34.4' W$$

1218. Middle-Latitude Sailing

Middle-latitude sailing combines plane sailing and parallel sailing. Plane sailing is used to find difference of latitude and departure when course and distance are known, or vice versa. Parallel sailing is used to interconvert departure and difference of longitude. The mean latitude (L_m) is normally used for want of a practical means of determining the middle latitude, or the latitude at which the arc length of the parallel separating the meridians passing through two specific points is exactly equal to the departure in proceeding from one point to the other.

The mean latitude (L_m) is half the arithmetic sum of the latitudes of two places on the same side of the equator. It is labeled N or S to indicate its position north or south of the equator. If a course line crosses the equator, solve each course line segment separately.

This sailing, like most elements of navigation, contains certain simplifying approximations which produce answers somewhat less accurate than those yielded by more rigorous solutions. For ordinary purposes, the solutions are more accurate than the navigation of the vessel using them. A correction could be applied to eliminate the error introduced by assuming that the departure and arrival meridians converge uniformly (as the two sides of a plane triangle), rather than as the approximate sine of the latitude. The correction is usually some correction to the middle latitude to obtain a "corrected middle latitude" for use in the solution. Tables for such correction have been published for both spherical and spheroidal earths. However, the actual correction is not a simple function of the middle latitude and DLo, as assumed, because the basic formulae of the sailing are themselves based upon a sphere, rather than a spheroid. Hence, the use of such a correction is misleading, and may introduce more error than it eliminates. The use of any correction is therefore not justified; if highly accurate results are required, a different solution should be used.

The formulae for these transformations are:

$$l = D (\cos C) \therefore \cos C = l / D$$

$$p = D (\sin C) \therefore \sin C = p / D$$

$$\tan C = p / l$$

$$DLo = p / (\cos Lm) \quad p = (DLo) (\cos Lm)$$

The labels (N, S, E, W) of l , p , and C are determined by noting the direction of motion or the relative positions of the two places.

Example 1: A vessel steams 1,253 nm on course 070° from lat. 15°17.0' N, λ 151°37.0' E.

Required: Latitude and longitude of the point of arrival by (1) computation and (2) traverse table.

Solution:

(1) Solution by computation:

$$D = 1253.0 \text{ nm}$$

$$Cn = 070^\circ T \therefore C = N 070^\circ E$$

$$l = (1,253.0) (\cos 070^\circ) = 428.6' N = 7^\circ 08.6' N$$

$$p = (1,253.0) (\sin 070^\circ) = 1,177.4 \text{ nm E}$$

$$L_1 = 15^\circ 17.0' N$$

$$+l = 7^\circ 08.6' N$$

$$L_2 = 22^\circ 25.6' N$$

$$L_m = 18^\circ 51.3' N = 18.855^\circ$$

$$DLo = p / (\cos Lm) = 1,177.4 / \cos 18.855^\circ = 1,244.2'$$

$$DLo = 1,244.2' E = 20^\circ 44.2' E$$

$$\lambda_1 = 151^\circ 37.0' E$$

$$\pm DLo \quad 20^\circ 44.2' E$$

$$\lambda_2 = 172^\circ 21.2' E$$

Answer:

$$L_2 = 22^\circ 25.6' N$$

$$\lambda_2 = 172^\circ 21.2' E$$

(2) Solution by traverse tables: Refer to Figure 1218a. Enter the traverse table with course 070° and distance 1,253 nm. Because a number as high as 1,253 is not tabulated in the Dist. column, obtain the values for D. Lat. and Dep. for a distance of 125.3 nm and multiply them by 10. Interpolating between the tabular distance arguments yields D. Lat. = 429' and Dep. = 1,178 nm. Converting the D. Lat. value to degrees of latitude yields 7° 09.0'. The point of arrival's latitude, therefore, is 22° 26' N. This results in a mean latitude of 18° 51.5' N.

Reenter the table with the mean latitude as course angle and substitute DLo as the heading of the Dist. column and Dep. as the heading of the D. Lat. column. Since the table is computed for integral degrees of course angle (or latitude), the tabulations in the pages for 18° and 19° must be interpolated for the minutes of L_m . In the 18° table, interpolate for DLo between the departure values of 117.0 nm and 117.9 nm. This results in a DLo value of 123.9. In the 19° table, interpolate for DLo between the departure values of 117.2 and 118.2. This yields a DLo value of 124.6.

Having obtained the DLo values corresponding to mean latitudes of 18° and 19°, interpolate for the actual value of the mean latitude: 18° 51.5' N. This yields the value of DLo = 124.5'. Multiply this final value by ten to obtain DLo = 1,245' = 20° 45' E.

Add the changes in latitude and longitude to the original position's latitude and longitude to obtain the final position.

Answer:

$$L_2 = 22^\circ 26' N$$

$$\lambda_2 = 172^\circ 22.0' E$$

Example 2: A vessel at lat. 8°48.9'S, λ . 89°53.3'W is to proceed to lat. 17°06.9'S, λ 104°51.6'W.

Required: Course and distance by (1) computation and (2) traverse table.

Solution:

(1) Solution by computation:

$$p = DLo (\cos L_m)$$

$$\tan C = p / l$$

$$D = l / (\cos C)$$

The labels (N, S, E, W) of l, p, and C are determined by noting the direction of motion or the relative positions of the two places.

$$DLo = 14^\circ 58.3' W = 898.3'$$

$$L_m = 12^\circ 57.9' S = 12.965^\circ S$$

$$p = (898.3') (\cos 12.965^\circ) = 875.4' = 875.4 \text{ nm}$$

$$L_1 = 8.815^\circ \text{ and } L_2 = 17.115^\circ$$

$$l = 17.115^\circ - 8.815^\circ = 8.3^\circ = 498'$$

$$C = \arctan (875.4'/498') = \arctan (1.7578) = S 60.4^\circ W$$

$$C_n = 240.4^\circ T$$

$$D = 498' / (\cos 60.4^\circ) = 498' / (.4939) = 1,008.3 \text{ nm}$$

Answer:

$$C_n = 240.4^\circ$$

$$D = 1008.2 \text{ nm}$$

(2) Solution by traverse tables: Refer to Figure 1218b. Enter the traverse table with the mean latitude as course angle and substitute DLo as the heading of the Dist. column and Dep. as the heading of the D. Lat. column. Since the table is computed for integral values of course angle (or latitude), it is usually necessary to extract the value of departure for values just less and just greater than the L_m and then interpolate for the minutes of L_m . In this case where L_m is almost 13°, enter the table with L_m 13° and DLo 898.3' to find Dep. 875 nm. The departure is found for DLo 89.9', and then multiplied by 10.

Reenter the table to find the numbers 875 and 498 beside each other in the columns labeled Dep. and D. Lat., respectively. Because these high numbers are not tabulated, divide them by 10, and find 87.5 and 49.8. This occurs most nearly on the page for course angle 60°. Interpolating for intermediate values, the corresponding number in the Dist. column is about 100.5. Multiplying this by 10, the distance is about 1005 nm.

Answer:

$$C = 240^\circ$$

$$D = 1005 \text{ nm.}$$

The labels (N, S, E, W) of l, p, DLo, and C are determined by noting the direction of motion or the relative positions of the two places.

1219. Mercator Sailing

Mercator sailing problems can be solved graphically on a Mercator chart. For mathematical solution, the formulas of Mercator sailing are:

$$\tan C = DLo/m \therefore DLo = m (\tan C)$$

After solving for course angle by Mercator sailing, solve for distance using the plane sailing formula:

$$D = l / (\cos C)$$

The labels (N, S, E, W) of l, p, DLo and C are determined by noting the direction of motion or the relative positions of the two places.

If the true course is near 090° or 270°, a small error in C introduces a large error in DLo. Thus, solving C to the

$\frac{340^\circ}{200^\circ}$		$\frac{020^\circ}{160^\circ}$		TABLE 4									$\frac{340^\circ}{200^\circ}$		$\frac{020^\circ}{160^\circ}$	
Traverse		20°									Table					
Dist.	D. Lat.	Dep.	Dist.	D. Lat.	Dep.	Dist.	D. Lat.	Dep.	Dist.	D. Lat.	Dep.	Dist.	D. Lat.	Dep.		
1	0.9	0.3	61	57.3	20.9	121	113.7	41.4	181	170.1	61.9	241	226.5	82.4		
2	1.9	0.7	62	58.3	21.2	22	114.6	41.7	82	171.0	62.2	42	227.4	82.8		
3	2.8	1.0	63	59.2	21.5	23	115.6	42.1	83	172.0	62.6	43	228.3	83.1		
4	3.8	1.4	64	60.1	21.9	24	116.5	42.4	84	172.9	62.9	44	229.3	83.5		
5	4.7	1.7	65	61.1	22.2	25	117.5	42.8	85	173.8	63.3	45	230.2	83.8		
6	5.6	2.1	66	62.0	22.6	26	118.4	43.1	86	174.8	63.6	46	231.2	84.1		
7	6.6	2.4	67	63.0	22.9	27	119.3	43.4	87	175.7	64.0	47	232.1	84.5		

Dist.	Dep.	D. Lat.	Dist.	Dep.	D. Lat.	Dist.	Dep.	D. Lat.	Dist.	Dep.	D. Lat.	Dist.	Dep.	D. Lat.		
$\frac{290^\circ}{250^\circ}$		$\frac{070^\circ}{110^\circ}$		70°												
Hypotenuse		Side Adj.											Side Opp.			

$\frac{342^\circ}{198^\circ}$		$\frac{018^\circ}{162^\circ}$		TABLE 4									$\frac{342^\circ}{198^\circ}$		$\frac{018^\circ}{162^\circ}$	
Traverse		18°									Table					
Dist.	D. Lat.	Dep.	Dist.	D. Lat.	Dep.	Dist.	D. Lat.	Dep.	Dist.	D. Lat.	Dep.	Dist.	D. Lat.	Dep.		
1	1.0	0.3	61	58.0	18.9	121	115.1	37.4	181	172.1	55.9	241	229.2	74.5		
2	1.9	0.6	62	59.0	19.2	22	116.0	37.7	82	173.1	56.2	42	230.2	74.8		
3	2.9	0.9	63	59.9	19.5	23	117.0	38.0	83	174.0	56.6	43	231.1	75.1		
4	3.8	1.2	64	60.9	19.8	24	117.9	38.3	84	175.0	56.9	44	232.1	75.4		
5	4.8	1.5	65	61.8	20.1	25	118.9	38.6	85	175.9	57.2	45	233.0	75.7		

Dist.	Dep.	D. Lat.	Dist.	Dep.	D. Lat.	Dist.	Dep.	D. Lat.	Dist.	Dep.	D. Lat.	Dist.	Dep.	D. Lat.		
$\frac{288^\circ}{252^\circ}$		$\frac{072^\circ}{108^\circ}$		72°												
D Lo		Dep.											m		D Lo	

$\frac{341^\circ}{199^\circ}$		$\frac{019^\circ}{161^\circ}$		TABLE 4									$\frac{341^\circ}{199^\circ}$		$\frac{019^\circ}{161^\circ}$	
Traverse		19°									Table					
Dist.	D. Lat.	Dep.	Dist.	D. Lat.	Dep.	Dist.	D. Lat.	Dep.	Dist.	D. Lat.	Dep.	Dist.	D. Lat.	Dep.		
1	0.9	0.3	61	57.7	19.9	121	114.4	39.4	181	171.1	58.9	241	227.9	78.5		
2	1.9	0.7	62	58.6	20.2	22	115.4	39.7	82	172.1	59.3	42	228.8	78.8		
3	2.8	1.0	63	59.6	20.5	23	116.3	40.0	83	173.0	59.6	43	229.8	79.1		
4	3.8	1.3	64	60.5	20.8	24	117.2	40.4	84	174.0	59.9	44	230.7	79.4		
5	4.7	1.6	65	61.5	21.2	25	118.2	40.7	85	174.9	60.2	45	231.7	79.8		

Dist.	Dep.	D. Lat.	Dist.	Dep.	D. Lat.	Dist.	Dep.	D. Lat.	Dist.	Dep.	D. Lat.	Dist.	Dep.	D. Lat.		
$\frac{289^\circ}{251^\circ}$		$\frac{071^\circ}{109^\circ}$		71°												
D Lo		Dep.											m		D Lo	

Figure 1218a. Extracts from the Table 4.

347° 013°			TABLE 4									347° 013°		
193° 167°			Traverse 13° Table									193° 167°		
Dist.	D. Lat.	Dep.	Dist.	D. Lat.	Dep.	Dist.	D. Lat.	Dep.	Dist.	D. Lat.	Dep.	Dist.	D. Lat.	Dep.
27	28.3	6.1	87	84.8	19.6	47	143.2	33.1	07	201.7	46.6	67	260.2	60.1
28	27.3	6.3	88	85.7	19.8	48	144.2	33.3	08	202.7	46.8	68	261.1	60.3
29	28.3	6.5	89	86.7	20.0	49	145.2	33.5	09	203.6	47.0	69	262.1	60.5
30	29.2	6.7	90	87.7	20.2	50	146.2	33.7	10	204.6	47.2	70	263.1	60.7
283° 077°			77°									257° 103°		
			Dist.			D. Lat.			Dep.					
			D Lo			Dep.			m			D Lo		

Figure 1218b. Extract from Table 4.

$$D = l / (\cos C)$$

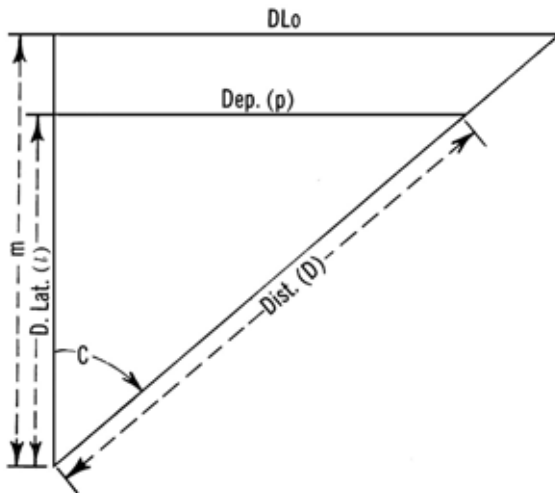

Figure 1219a. Mercator and plane sailing relationship.

nearest 0.1°, as is done by the traverse tables, may introduce a large error in DLo if the true course is near due east or west.

Example 1: A ship at lat. 32°14.7'N, λ 66°28.9'W is to head for a point near Chesapeake Light, lat. 36°58.7'N, λ 75°42.2'W.

Required: Course and distance by (1) computation and (2) traverse table.

Solution:

(1) Solution by computation:

$$\tan C = (DLo) / m \therefore DLo = m(\tan C)$$

First calculate the meridional difference by entering Table 6 Meridional Parts and interpolating for the meridional parts for the original and final latitudes. The meridional difference is the difference between these two values. Having calculated the meridional difference, solve for course and distance using the equations above. Figure 1219a depicts the relationship between Mercator and plane sailings.

$$M_2 (36^\circ 58.7' N) = 2377.1$$

$$M_1 (32^\circ 14.7' N) = 2033.4$$

$$m = 343.7$$

$$\lambda_2 = 075^\circ 42.2' W$$

$$\lambda_1 = 066^\circ 28.9' W$$

$$DLo = 9^\circ 13.3' W = 553.3' W$$

$$\tan C = DLo / m \therefore C = \arctan (DLo / m)$$

$$= \arctan (553.3 / 343.7) = N 58.2^\circ W$$

$$\therefore C_n = 301.8^\circ T$$

$$L_2 = 36^\circ 58.7' N$$

$$L_1 = 32^\circ 14.7' N$$

$$l = 4^\circ 44.0' = 284.0'$$

$$D = l / (\cos C) = 284.0' / (\cos 58.2^\circ) = 538.9 \text{ nm}$$

Answer:

$$C = 301.8^\circ T$$

$$D = 538.9 \text{ nm}$$

(2) Solution by traverse table: Refer to Figure 1219b. Substitute m as the heading of the D. Lat. column and DLo as the heading of the Dep. column. Inspect the table for the numbers 343.7 and 553.3 in the columns relabeled m and DLo, respectively. Because a number as high as 343.7 is not tabulated in the m column, it is necessary to divide m and DLo by 10. Then inspect to find 34.4 and 55.3 abreast in the

$\frac{328^\circ}{212^\circ} \mid \frac{032^\circ}{148^\circ}$		TABLE 4 Traverse 32° Table									$\frac{328^\circ}{212^\circ} \mid \frac{032^\circ}{148^\circ}$			
Dist.	D. Lat.	Dep.	Dist.	D. Lat.	Dep.	Dist.	D. Lat.	Dep.	Dist.	D. Lat.	Dep.	Dist.	D. Lat.	Dep.
1	0.8	0.5	61	51.7	32.3	121	102.6	64.1	181	153.5	96.9	241	204.4	127.7
2	1.7	1.1	62	52.6	32.9	22	103.5	64.7	82	154.3	96.4	42	205.2	128.2
3	2.5	1.6	63	53.4	33.4	23	104.3	65.2	83	155.2	97.0	43	206.1	128.8
4	3.4	2.1	64	54.8	33.9	24	105.2	65.7	84	156.0	97.5	44	206.9	129.3
5	4.2	2.6	65	55.1	34.4	25	106.0	66.2	85	156.9	98.0	45	207.8	129.8
6	5.1	3.2	66	56.0	35.0	26	106.9	66.8	86	157.7	98.6	46	208.6	130.4

351	297.7	186.0	411	348.5	217.8	471	399.4	249.6	531	450.3	281.4	591	501.2	313.2
52	298.5	186.5	12	349.4	218.3	72	400.3	250.1	32	451.2	281.9	92	502.0	313.7
53	299.4	187.1	13	350.2	218.9	73	401.1	250.7	33	452.0	282.4	93	502.9	314.2
54	300.2	187.6	14	351.1	219.4	74	402.0	251.2	34	452.9	283.0	94	503.7	314.8
55	301.1	188.1	15	351.9	219.9	75	402.8	251.7	35	453.7	283.5	95	504.6	315.3
56	301.9	188.7	16	352.8	220.4	76	403.7	252.2	36	454.6	284.0	96	505.4	315.8
57	302.8	189.2	17	353.6	221.0	77	404.5	252.8	37	455.4	284.6	97	506.3	316.4
58	303.6	189.7	18	354.5	221.5	78	405.4	253.3	38	456.2	285.1	98	507.1	316.9
59	304.4	190.2	19	355.3	222.0	79	406.2	253.8	39	457.1	285.6	99	508.0	317.4
60	305.3	190.8	20	356.2	222.6	80	407.1	254.4	40	457.9	286.2	600	508.8	318.0

$\frac{302^\circ}{238^\circ} \mid \frac{058^\circ}{122^\circ}$		58°			
Dist.	D. Lat.	Dep.	Dist.	D. Lat.	Dep.
D Lo	Dep.				
	m	D Lo			

Figure 1219b. Extract from Table 4 composed of parts of left and right hand pages for course angle 58°.

m and *DLo* columns, respectively. This occurs most nearly on the page for course angle 58° or course 302°. Reenter the table with course 302° to find *Dist.* for *D. Lat.* 284.0'. This distance is 536 miles.

Answer:

Cn = 302° *T*
D = 536 nm

Example 2: A ship at lat. 75°31.7' N, λ 79°08.7' W, in Baffin Bay, steams 263.5 nm on course 155°.

Required: Latitude and longitude of point of arrival by (1) computation and (2) traverse table.

Solution:

(1) Solution by computation:

$l = D (\cos C)$; and $DLo = m (\tan C)$

$D = 263.5 \text{ nm}$

$Cn = 155^\circ T \therefore C = S 25^\circ E$

$l = 263.5 (\cos 25^\circ) = 238.8' S = 3^\circ 58.8' S$

$L_1 \quad 75^\circ 31.7' N$

$+ l \quad 3^\circ 58.8' S$

$L_2 \quad 71^\circ 32.9' N$

$M_1 = 7072.4$

$M_2 = 6226.1$

$m = 846.3$

$DLo = 846.3 (\tan 25^\circ) = 394.6' E = 6^\circ 34.6'$

$DLo = 6^\circ 34.6' E$

$\lambda_1 = 079^\circ 08.7' W$

$+ DLo \quad 6^\circ 34.6' E$

$\lambda_2 = 072^\circ 34.1' W$

Answer:

$L_2 = 71^\circ 32.9' N$

$\lambda_2 = 072^\circ 34.1' W$

The labels (*N*, *S*, *E*, *W*) of *l*, *DLo*, and *C* are determined by noting the direction of motion or the relative positions of the two places. Here the vessel is steaming SE'ly.

(2) Solution by traverse table: Refer to Figure 1219c. Enter the traverse table with course 155° and *Dist.* 263.5 nm to find *D. Lat.* 238.8'. The latitude of the point of arrival is found by subtracting the *D. Lat.* from the latitude of the point of departure. Determine the meridional difference by Table 5 (Travers Table) Table 4 ($m = 846.3$).

335° 025°		TABLE 4									335° 025°				
205° 155°		Traverse 25° Table									205° 155°				
Dist.	D. Lat.	Dep.	Dist.	D. Lat.	Dep.	Dist.	D. Lat.	Dep.	Dist.	D. Lat.	Dep.	Dist.	D. Lat.	Dep.	
21	19.0	8.9	81	73.4	34.2	141	127.8	59.6	201	182.2	84.9	261	238.5	110.3	
22	19.9	9.3	82	74.3	34.7	42	128.7	60.0	02	183.1	85.4	62	237.5	110.7	
23	20.8	9.7	83	75.2	35.1	43	129.6	60.4	03	184.0	85.8	63	238.4	111.1	
24	21.8	10.1	84	76.1	35.5	44	130.5	60.9	04	184.9	86.2	64	239.3	111.6	
25	22.7	10.6	85	77.0	35.9	45	131.4	61.3	05	185.8	86.6	65	240.2	112.0	
33	29.9	13.9	93	84.3	39.3	53	138.7	64.7	13	193.0	90.0	73	247.4	115.4	
34	30.8	14.4	94	85.2	39.7	54	139.6	65.1	14	193.9	90.4	74	248.3	115.8	
Dist.	Dep.	D. Lat.	Dist.	Dep.	D. Lat.	Dist.	Dep.	D. Lat.	Dist.	Dep.	D. Lat.	Dist.	Dep.	D. Lat.	
295° 065°		65°									245° 115°				
Dist.		D. Lat.		Dep.		Dist.		D. Lat.		Dep.		Dist.		D. Lat.	
D Lo		Dep.		m		D Lo		Dep.		m		D Lo		Dep.	

Figure 1219c. Extract from Table 4.

Reenter the table with course 155° to find the DLo corresponding to $m = 846.3$. Substitute meridional difference m as the heading of the D. Lat. column and DLo as the heading of the Dep. column. Because a number as high as 846.3 is not tabulated in the m column, divide m by 10 and then inspect the m column for a value of 84.6. Interpolating as necessary, the latter value is opposite DLo 39.4'. The DLo is 394' ($39.4' \times 10$). The longitude of the point of arrival is found by applying the DLo to the longitude of the point of departure.

Answer:

$L_2 = 71^\circ 32.9' N.$

$\lambda_2 = 072^\circ 34.7' W.$

1220. Additional Problems

Example: A vessel steams 117.3 nm on course 214° T.

Required: (1) Difference of latitude, (2) departure, by plane sailing.

Answers: (1) l 97.2'S, (2) p 65.6 nm W.

Example: A steamer is bound for a port 173.3 nm south and 98.6 nm east of the vessel's position

Required: (1) Course, (2) distance, by plane sailing.

Answers: (1) C 150.4°; (2) D 199.4 nm by computation, 199.3 nm by traverse table.

Example: A ship steams as follows: course 359° T, distance 28.8 nm; course 006°, distance 16.4 miles; course 266° T, distance 4.9 nm; course 144°, distance 3.1 nm; course 333° T, distance 35.8 nm; course 280°, distance 19.3 nm.

Required: (1) Course, (2) distance, by traverse sailing.

Answers: (1) Cn 334.4° T, (2) D 86.1 nm.

Example: The 1530 DR position of a ship is lat. 44°36.3'N, λ 031°18.3'W. The ship is on course 270° T, speed 17 knots.

Required: The 2000 DR position, by parallel sailing.

Answer: 2000 DR: L 44°36.3'N, λ 033°05.7'W.

Example: A ship at lat. 33°53.3'S, λ 018°23.1'E, leaving Cape Town, heads for a destination near Ambrose Light, lat. 40°27.1'N, λ 073°49.4'W.

Required: (1) Course and (2) distance, by Mercator sailing.

Answers: (1) Cn = 310.9° T; (2) D 6,811.5 nm by computation, 6,812.8 mi. by traverse table.

Example: A ship at lat. 15°03.7'N, λ . 151°26.8'E steams

57.4 nm on course $035^\circ T$.

Answers: (1) $L 15^\circ 50.7'N$; (2) $\lambda 152^\circ 00.7'E$.

Required: (1) Latitude and (2) longitude of the point of arrival, by Mercator sailing.

CHAPTER 13

NAVIGATIONAL ASTRONOMY

PRELIMINARY CONSIDERATIONS

1300. Definitions

The science of Astronomy studies the positions and motions of celestial bodies and seeks to understand and ex-

plain their physical properties. Navigational astronomy deals with their coordinates, time, and motions. The symbols commonly recognized in navigational astronomy are given in Table 1300.

Celestial Bodies	
☉ Sun	☾ Lower limb
☾ Moon	☉ Center
☿ Mercury	☽ Upper limb
♀ Venus	● New moon
⊕ Earth	☾ Crescent moon
♂ Mars	☽ First quarter
♃ Jupiter	☾ Gibbous moon
♄ Saturn	☽ Full moon
♅ Uranus	☾ Gibbous moon
♆ Neptune	☽ Last quarter
♇ Pluto	☾ Crescent moon
☆ Star	
☆-P Star-planet altitude correction (altitude)	
Miscellaneous Symbols	
ʸ Years	* Interpolation impractical
^m Months	° Degrees
^d Days	' Minutes of arc
^h Hours	" Seconds of arc
^m Minutes of time	♋ Conjunction
^s Seconds of time	♌ Opposition
■ Remains below horizon	□ Quadrature
□ Remains above horizon	♊ Ascending node
//// Twilight all night	♋ Descending node
♈ Aries (vernal equinox)	

Table 1300. Astronomical symbols.

1301. The Celestial Sphere

Looking at the sky on a dark night, imagine that celestial bodies are located on the inner surface of a vast,

Earth-centered sphere (see Figure 1301). This model is useful since we are only interested in the relative positions and motions of celestial bodies on this imaginary surface. Understanding the concept of the celestial

sphere is most important when discussing sight reduction in Chapter 19.

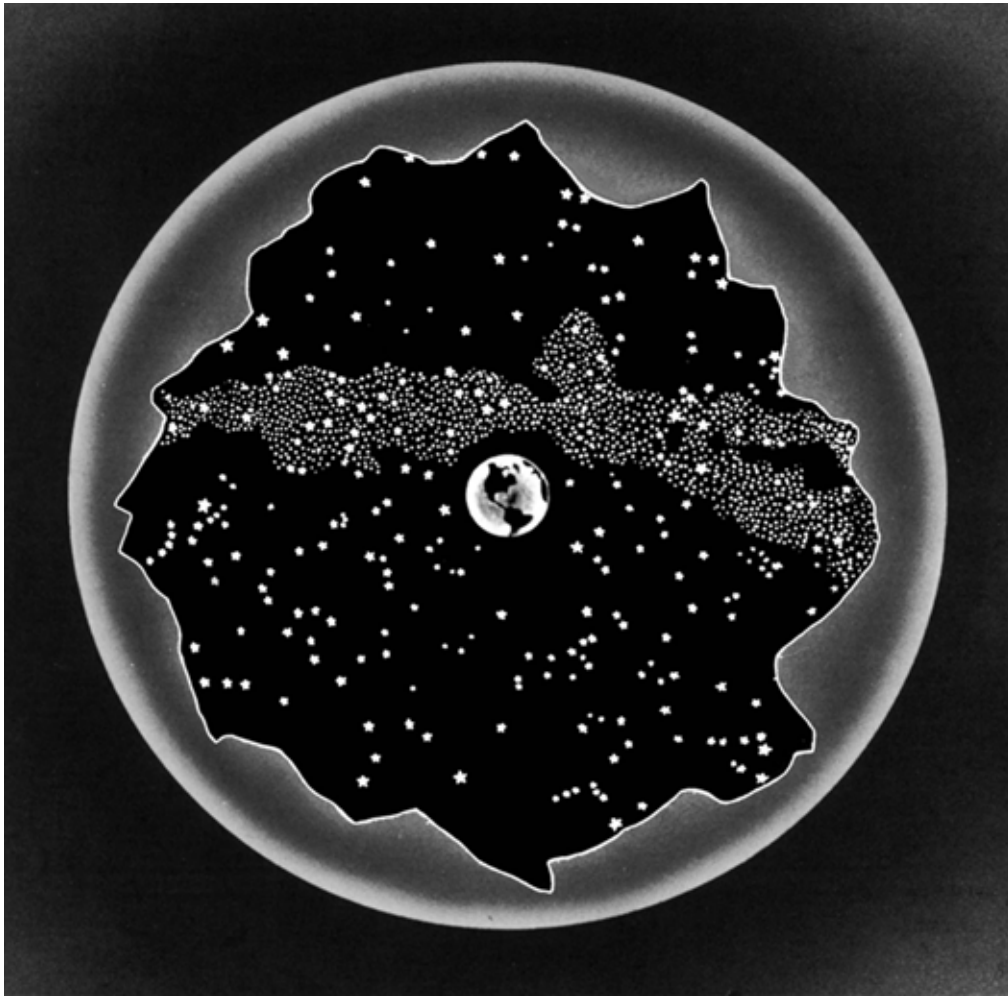

Figure 1301. The celestial sphere.

1302. Relative and Apparent Motion

Celestial bodies are in constant motion. There is no fixed position in space from which one can observe absolute motion. Since all motion is relative, the position of the observer must be noted when discussing planetary motion. From the Earth we see apparent motions of celestial bodies on the celestial sphere. In considering how planets follow their orbits around the Sun, we assume a hypothetical observer at some distant point in space. When discussing the rising or setting of a body on a local horizon, we must locate the observer at a particular point on the Earth because the setting Sun for one observer may be the rising Sun for another.

Apparent motion on the celestial sphere results from the motions in space of both the celestial body and the Earth. Without special instruments, motions toward and away from the Earth cannot be discerned.

1303. Astronomical Distances

We can consider the celestial sphere as having an infinite radius because distances between celestial bodies are so vast. For an example in scale, if the Earth were represented by a ball one inch in diameter, the Moon would be a ball one-fourth inch in diameter at a distance of 30 inches, the Sun would be a ball nine feet in diameter at a distance of nearly a fifth of a mile, and Pluto would be a ball half an inch in diameter at a distance of about seven miles. The nearest star would be one-fifth of the actual distance to the Moon.

Because of the size of celestial distances, it is inconvenient to measure them in common units such as the mile or kilometer. The mean distance to our nearest neighbor, the Moon, is 238,855 miles. For convenience this distance is sometimes expressed in units of the equatorial radius of the Earth: 60.27 Earth radii.

Distances between the planets are usually expressed in

terms of the **astronomical unit (au)**, which closely corresponds to the average distance between the Earth and the Sun. This is approximately 92,960,000 miles. Thus the mean distance of the Earth from the Sun is 1 au. The mean distance of the dwarf planet Pluto is about 39.5 au. Expressed in astronomical units, the mean distance from the Earth to the Moon is 0.00257 au.

Distances to the stars require another leap in units. A commonly-used unit is the **light-year**, the distance light travels in one year. Since the speed of light is about 1.86×10^5 miles per second and there are about 3.16×10^7 seconds per year, the length of one light-year is about 5.88×10^{12} miles. The nearest stars, Alpha Centauri and its neighbor Proxima, are 4.3 light-years away. Relatively few stars are less than 100 light-years away. The nearest galaxy of comparable size to our own Milky Way is the Andromeda Galaxy, at a distance of about 2.5 million light years. The most distant galaxies observed by astronomers are 13 billion light years away, just at the edge of the visible universe.

1304. Magnitude

The relative brightness of celestial bodies is indicated by a scale of stellar **magnitudes**. Initially, astronomers divided the stars into 6 groups according to brightness. The 20 brightest were classified as of the first magnitude, and the dimmest were of the sixth magnitude. In modern times, when it became desirable to define more precisely the limits of magnitude, a first magnitude star was considered 100 times brighter than one of the sixth magnitude. Since the fifth root of 100 is 2.512, this number is considered the

magnitude ratio. A first magnitude star is 2.512 times as bright as a second magnitude star, which is 2.512 times as bright as a third magnitude star. A second magnitude is $2.512 \times 2.512 = 6.310$ times as bright as a fourth magnitude star. A first magnitude star is 2.512^{20} times as bright as a star of the 21st magnitude, the dimmest that can be seen through a 200-inch telescope. It is important to note the higher the magnitude, the dimmer the object.

Stars vary in color; i.e., some are more red than others. Therefore, the brightness of a star is a function of what “detector” is being used. For example, stars that are more red than others appear brighter using a detector that is most sensitive in red wavelengths. Thus, it is common when defining magnitudes to include an idea of the detector. For navigation, most magnitudes are described as “visual”, or how the object would look to the unaided eye, but sometimes you will see other magnitude bands. If no band is given assume that the magnitude is visual.

Brightness is normally tabulated to the nearest 0.1 magnitude, about the smallest change that can be detected by the unaided eye of a trained observer. All stars of magnitude 1.50 or brighter are popularly called “first magnitude” stars. Those between 1.51 and 2.50 are called “second magnitude” stars, those between 2.51 and 3.50 are called “third magnitude” stars, etc. Sirius, the brightest star, has a magnitude of -1.6 . The only other star with a negative magnitude is Canopus, -0.9 . At greatest brilliance Venus has a magnitude of about -4.4 . Mars, Jupiter, and Saturn are sometimes of negative magnitude. The full Moon has a magnitude of about -12.7 , but varies somewhat. The magnitude of the Sun is about -26.7 .

THE UNIVERSE

1305. The Solar System

The Sun, the most conspicuous celestial object in the sky, is the central body of the solar system. Associated with it are eight planets, five dwarf planets like Pluto, and thousands of asteroids, comets, and meteors. All planets other than Mercury and Venus have moons.

1306. Motions of Bodies of the Solar System

Astronomers distinguish between two principal motions of celestial bodies. **Rotation** is a spinning motion about an axis within the body, whereas **revolution** is the motion of a body in its orbit around another body. The body around which a celestial object revolves is known as that body’s **primary**. For the moons (satellites), the primary is a planet. For the planets, the primary is the Sun. The entire solar system is held together by the gravitational force of the Sun. The whole system revolves around the center of the Milky Way galaxy and the Milky Way is in motion relative to its neighboring galaxies.

The hierarchies of motions in the universe are caused by the force of gravity. As a result of gravity, bodies attract each other in proportion to their masses and to the inverse square of the distances between them. This force causes the planets to go around the sun in nearly circular, elliptical orbits.

The laws governing the motions of planets in their orbits were discovered by Johannes Kepler, and are now known as **Kepler’s laws**:

1. The orbits of the planets are ellipses, with the sun at the common focus.
2. The straight line joining the sun and a planet (the **radius vector**) sweeps over equal areas in equal intervals of time.
3. The squares of the sidereal periods of any two planets are proportional to the cubes of their mean distances from the sun.

In 1687 Isaac Newton stated three “laws of motion,” which he believed were applicable to the planets. **Newton’s laws of motion** are:

1. Every body continues in a state of rest or of uniform motion in a straight line unless acted upon by an external force.
2. When a body is acted upon by an external force, its acceleration is directly proportional to that force, and inversely proportional to the mass of the body, and acceleration take place in the direction in which the force acts.
3. To every action there is an equal and opposite reaction.

Newton also stated a single **universal law of gravitation**, which he believed applied to all bodies, although it was based upon observations with the solar system only:

Every particle of matter attracts every other particle with a force that varies directly as the product of their masses and inversely as the square of the distance between them.

From these fundamental laws of motion and gravitation, Newton derived Kepler's empirical laws. He proved rigorously that the gravitational interaction between any two bodies results in an orbital motion of each body about the barycenter of the two masses that form a conic section, that is a circle, ellipse, parabola, or hyperbola.

Circular and parabolic orbits are unlikely to occur in nature because of the precise speeds required. Hyperbolic orbits are open, that is one body, due to its speed, recedes into space. Therefore, a planet's orbit must be elliptical as found by Kepler.

Both the sun and each body revolve about their common center of mass. Because of the preponderance of the mass of the sun over that of the individual planets, the common center of the sun and each planet except Jupiter lies with the sun. The common center of the combined mass of the solar system moves in and out of the sun.

The various laws governing the orbits of planets apply equally well to the orbit of any body with respect to its primary.

In each planet's orbit, the point nearest the Sun is called the **perihelion**. The point farthest from the Sun is called the **aphelion**. The line joining perihelion and aphelion is called the **line of apsides**. In the orbit of the Moon, the point nearest the Earth is called the **perigee**, and that point farthest from the Earth is called the **apogee**. Figure 1306 shows the orbit of the Earth (with exaggerated eccentricity), and the orbit of the Moon around the Earth.

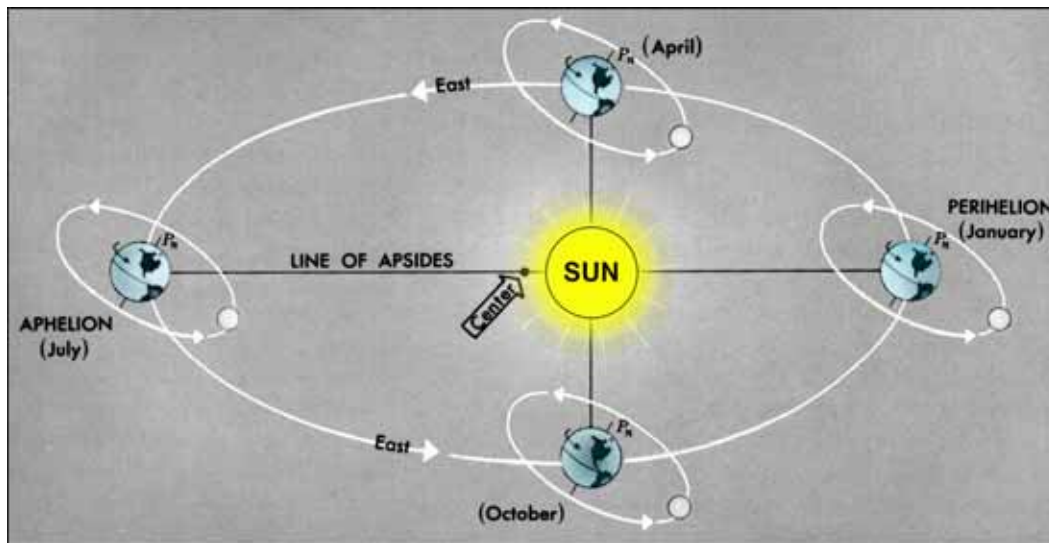

Figure 1306. Orbits of the Earth and Moon.

1307. The Sun

The Sun dominates our solar system. Its mass is nearly a thousand times that of all other bodies of the solar system combined. Its diameter is about 865,000 miles. Since it is a star, it generates its own energy through a thermonuclear reaction, thereby providing heat and light for the entire solar system.

The distance from the Earth to the Sun varies from 91,300,000 at perihelion to 94,500,000 miles at aphelion. When the Earth is at perihelion, which always occurs early in January, the Sun appears largest, 32.6' of arc in diameter. Six months later at aphelion, the Sun's apparent diameter is a minimum of 31.5'. Reductions of celestial navigation

sights taken of the Sun's limb take this change of apparent size into account.

Observations of the Sun's surface (called the **photosphere**) reveal small dark areas called **sunspots**. These are areas of intense magnetic fields in which relatively cool gas (at 7000°F.) appears dark in contrast to the surrounding hotter gas (10,000°F.). Sunspots vary in size from perhaps 50,000 miles in diameter to the smallest spots that can be detected (a few hundred miles in diameter). They generally appear in groups. See Figure 1307.

Surrounding the photosphere is an outer **corona** of very hot but tenuous gas. This can only be seen during an eclipse of the Sun, when the Moon blocks the light of the photosphere.

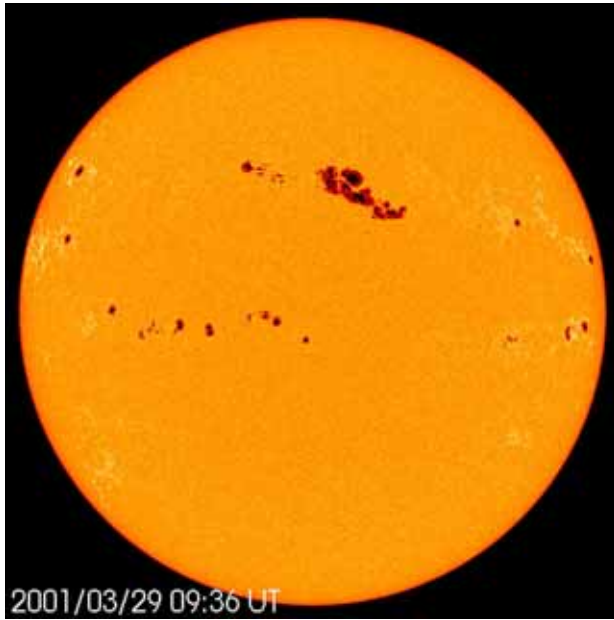

Figure 1307. The huge sunspot group observed on March 30, 2001 spanned an area 13 times the entire surface of the Earth. Courtesy of SOHO a project of international cooperation between ESA and NASA.

The Sun is continuously emitting charged particles, which form the **solar wind**. As the solar wind sweeps past the Earth, these particles interact with the Earth's magnetic field. If the solar wind is particularly strong, the interaction can produce magnetic storms which adversely affect radio signals on the Earth and can interfere with satellite communications. At such times the **auroras** are particularly brilliant and widespread.

The Sun is moving approximately in the direction of Vega at about 12 miles per second, or about two-thirds as fast as the Earth moves in its orbit around the Sun.

1308. The Planets

The principal bodies orbiting the Sun are called **planets**. Eight planets are known; in order of their distance from the Sun, they are: Mercury, Venus, Earth, Mars, Jupiter, Saturn, Uranus, and Neptune. Pluto, formerly considered a planet, is now classified as a dwarf planet. All of the planets revolve around the Sun in the same direction in nearly circular orbits. All of the planets are spherical or nearly so, all have regular rotation rates, and all shine by reflected sunlight. All except Mercury have substantial atmospheres. Only four of the planets are commonly used for celestial navigation: Venus, Mars, Jupiter, and Saturn.

The orbits of the planets lie in nearly the same plane as the Earth's orbit. Therefore, as seen from the Earth, the planets are confined to a strip of the celestial sphere near the **ecliptic**, which is the intersection of the mean plane of the Earth's orbit around the Sun with the celestial sphere. Ex-

cept for Uranus and Neptune, the planets are bright enough to be easily seen by the unaided eye, although the brightness of each at any given time depends on its distance from the Earth and the fraction of the sunlit part observed.

Mercury and Venus, the two planets with orbits closer to the Sun than that of the Earth, are called **inferior planets**, and the others, with orbits farther from the Sun are called **superior planets**. The four planets nearest the Sun (Mercury through Mars) are called the inner planets, and the others (Jupiter through Neptune) are referred to as the outer planets. The outer planets are sometimes also called gas giants because they are so much larger than the others and have deep, dense atmospheres.

Planets can sometimes be identified in the sky by their appearance, because-unlike the stars-they do not twinkle. The stars are so distant that they are point sources of light. Therefore the stream of light from a star is easily disrupted by turbulence in the Earth's atmosphere, causing **scintillation** (the twinkling effect). The naked-eye planets, however, are close enough to present perceptible disks. The broader stream of light from a planet is not so easily disrupted.

The orbits of many thousands of minor planets, also called asteroids, lie chiefly between the orbits of Mars and Jupiter. These are all too faint to be seen without a telescope.

1309. The Earth

In common with other planets, the Earth **rotates** on its axis and **revolves** in its orbit around the Sun. These motions are the principal source of the daily apparent motions of other celestial bodies. The Earth's rotation also causes a deflection of water and air currents to the right in the Northern Hemisphere and to the left in the Southern Hemisphere. Because of the Earth's rotation, high tides on the open sea lag behind the meridian transit of the Moon.

For most navigational purposes, the Earth can be considered a sphere. However, like the other planets, the Earth is approximately an **oblate spheroid**, or **ellipsoid of revolution**, flattened at the poles and bulged at the equator. See Figure 1309. Therefore, the polar diameter is less than the equatorial diameter, and the meridians are slightly elliptical, rather than circular. The dimensions of the Earth are recomputed from time to time, as additional and more precise measurements become available. Since the Earth is not exactly an ellipsoid, results differ slightly when equally precise and extensive measurements are made on different parts of the surface.

1310. Inferior Planets (Mercury and Venus)

The orbits of Mercury and Venus are closer to the Sun than the Earth's orbit, thus they always appear in the neighborhood of the Sun. Over a period of weeks or months, they appear to oscillate back and forth from one

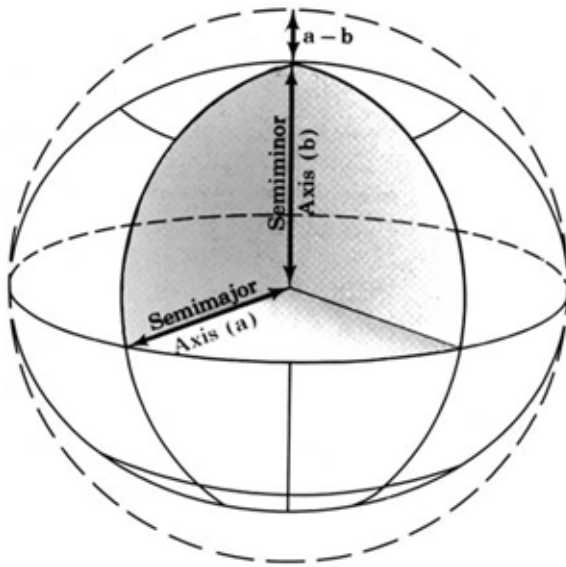

Figure 1309. Oblate spheroid or ellipsoid of revolution.

side of the Sun to the other. They are seen either in the eastern sky before sunrise or in the western sky after sunset. For brief periods they disappear into the Sun's glare. At this time they are between the Earth and Sun (known as **inferior conjunction**) or on the opposite side of the Sun from the Earth (**superior conjunction**). On rare occasions at inferior conjunction, the planet will cross the face of the Sun as seen from the Earth. This is known as a **transit of the Sun**.

When Mercury or Venus appears most distant from the Sun in the evening sky, it is at greatest eastern elongation. (Although the planet is in the western sky, it is at its easternmost point from the Sun.) From night to night the planet will appear to approach the Sun until it disappears into the glare of twilight. At this time it is moving between the Earth and Sun to inferior conjunction. A few days later, the planet will appear in the morning sky at dawn. It will gradually appear to move away from the Sun to its greatest western elongation, then move back toward the Sun. After disappearing in the morning twilight, it will move behind the Sun to superior conjunction. After this it will reappear in the evening sky, heading toward eastern elongation, beginning the cycle again. See Figure 1310.

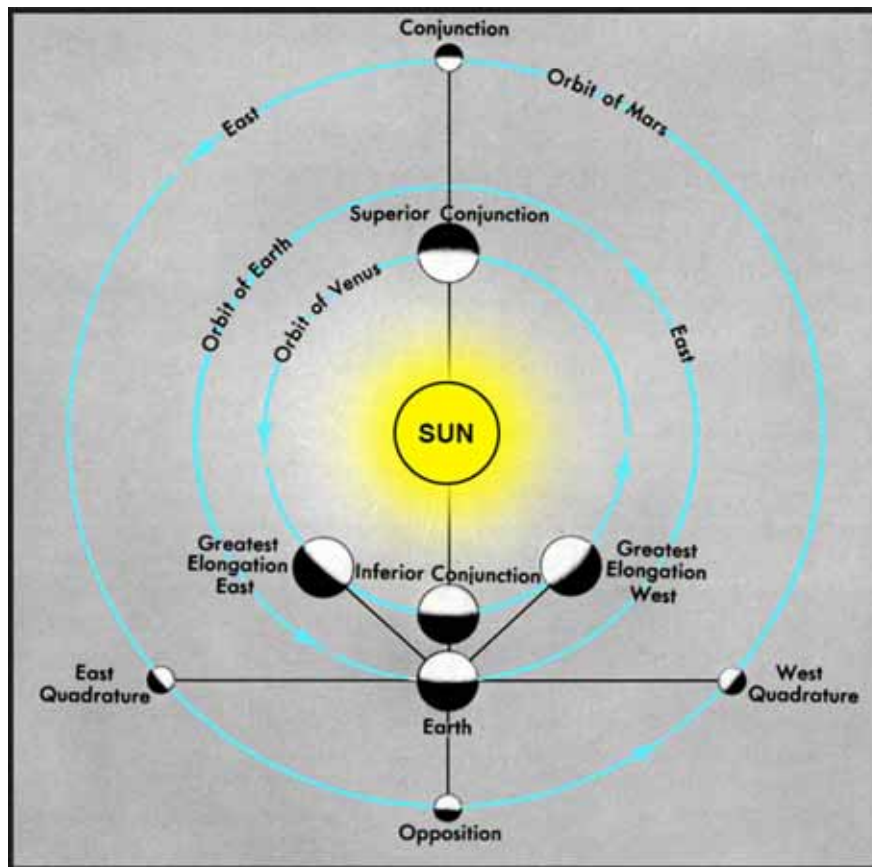

Figure 1310. Planetary configurations.

Mercury is never seen more than about 28° from the Sun. For this reason it is not commonly used for navigation.

Near greatest elongation it appears near the western horizon after sunset or the eastern horizon before sunrise. At these

times it resembles a first magnitude star and is sometimes reported as a new or strange object in the sky. The interval during which it appears as a morning or evening star can vary from about 30 to 50 days. Around inferior conjunction, Mercury is difficult to observe for about 5 days; near superior conjunction, it is as long as 35 days. Observed with a telescope, Mercury is seen to go through phases similar to those of the Moon.

Venus can reach a distance of 47° from the Sun, allowing it to dominate the morning or evening sky. At maximum brilliance, about five weeks before and after inferior conjunction, it has a magnitude of about -4.4 and is brighter than any other object in the sky except the Sun and Moon. At these times it can be seen during the day and is sometimes observed for a celestial line of position. It appears as a morning or evening "star" for approximately 263 days in succession. Near inferior conjunction Venus disappears for 8 days; around superior conjunction it disappears for 50 days. Through strong binoculars or a telescope, Venus can be seen to go through a full set of phases. This actually has the effect of offsetting Venus' center of light from its center of mass. Reductions of celestial navigation sights taken of Venus take this offset into account.

1311. Superior Planets (Mars, Jupiter, Saturn, Uranus, and Neptune)

All other planets besides Mercury and Venus have orbits further from the Sun than Earth's orbit; these are called superior planets. While Mercury and Venus never appear too far from the Sun, the superior planets are not confined to the proximity of the Sun as seen from the Earth. They can pass behind the Sun (**conjunction**), but they cannot pass between the Sun and the Earth. We see them move away from the Sun until they are opposite the Sun in the sky (**opposition**). When a superior planet is near conjunction, it rises and sets approximately with the Sun and is thus lost in the Sun's glare. Gradually it becomes visible in the early morning sky before sunrise. From day to day, it rises and sets earlier, becoming increasingly visible through the late night hours until dawn. At opposition, it will rise about when the Sun sets, be visible throughout the night, and set about when the Sun rises.

Observed against the background stars, the planets normally move eastward in what is called **direct motion**. Approaching opposition, however, a planet will slow down, pause (at a stationary point), and begin moving westward (**retrograde motion**), until it reaches the next stationary point and resumes its direct motion. This is not because the planet is moving strangely in space. This relative, observed motion results because the faster moving Earth is "catching up" with and "passing" by the slower moving superior planet.

The superior planets are brightest and closest to the Earth at opposition, when they are visible throughout the night. The interval between oppositions is known as the

synodic period. This period is longest for the closest planet, Mars, and becomes increasingly shorter for the outer planets.

Unlike Mercury and Venus, the superior planets do not go through a full cycle of phases. They are always full or highly gibbous. With the exception of Mars, the offset between a superior planet's center of light from its center of mass (due to phase) does not need to be accounted for in traditional celestial navigation. Reductions of celestial navigation sights of Mars often take this offset into account.

Mars can usually be identified by its orange color. It can become as bright as magnitude -2.8 but is more often between -1.0 and -2.0 at opposition. Oppositions occur at intervals of about 780 days. The planet is visible for about 330 days on either side of opposition. Near conjunction it is lost from view for about 120 days. Its two satellites can only be seen in a large telescope.

Jupiter, largest of the known planets, normally outshines Mars, regularly reaching magnitude -2.0 or brighter at opposition. Oppositions occur at intervals of about 400 days, with the planet being visible for about 180 days before and after opposition. The planet disappears for about 32 days at conjunction. Four satellites (of a total 67 currently known) are bright enough to be seen with binoculars. Their motions around Jupiter can be observed over the course of several hours.

Saturn, the outermost of the navigational planets, comes to opposition at intervals of about 380 days. It is visible for about 175 days before and after opposition, and disappears for about 25 days near conjunction. At opposition it becomes as bright as magnitude $+0.8$ to -0.2 . Through good, high powered binoculars, Saturn appears as elongated because of its system of rings. A telescope is needed to examine the rings in any detail. Saturn is now known to have at least 62 satellites, none of which are visible to the unaided eye.

Uranus, Neptune and the dwarf planet, **Pluto**, are too faint to be used for navigation; Uranus, at about magnitude 5.5, is faintly visible to the unaided eye.

1312. The Moon

The **Moon** is the only satellite of direct navigational interest. It revolves around the Earth once in about 27.3 days, as measured with respect to the stars. This is called the **sidereal month**. Because the Moon rotates on its axis with the same period with which it revolves around the Earth, the same side of the Moon is always turned toward the Earth. The cycle of phases depends on the Moon's revolution with respect to the Sun. This **synodic month** is approximately 29.53 days, but can vary from this average by up to a quarter of a day during any given month.

When the Moon is in conjunction with the Sun (new Moon), it rises and sets with the Sun and is lost in the Sun's glare. The Moon is always moving eastward at about 12.2° per day, so that sometime after conjunction (as little as 16

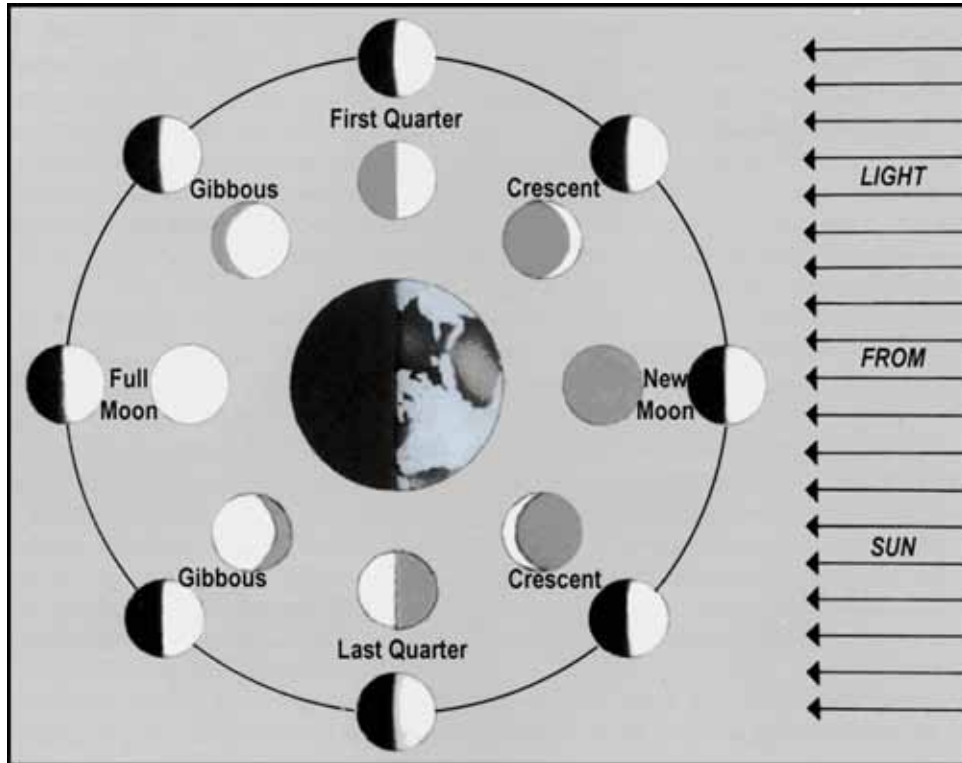

Figure 1312a. Phases of the Moon. The inner figures of the Moon represent its appearance from the Earth.

hours, or as long as two days), the thin lunar crescent can be observed after sunset, low in the west. For the next couple of weeks, the Moon will **wax**, becoming more fully illuminated. From day to day, the Moon will rise (and set) later, becoming increasingly visible in the evening sky, until (about 7 days after new Moon) it reaches first quarter, when the Moon rises about noon and sets about midnight. Over the next week the Moon will rise later and later in the afternoon until full Moon, when it rises about sunset and dominates the sky throughout the night. During the next couple of weeks the Moon will **wane**, rising later and later at night. By last quarter (a week after full Moon), the Moon rises about midnight and sets at noon. As it approaches new Moon, the Moon becomes an increasingly thin crescent, and is seen only in the early morning sky. Sometime before conjunction (16 hours to 2 days before conjunction) the thin crescent will disappear in the glare of morning twilight.

At full Moon, the Sun and Moon are on opposite sides of the ecliptic. Therefore, in the winter the full Moon rises early, crosses the celestial meridian high in the sky, and sets late; as the Sun does in the summer. In the summer the full Moon rises in the southeastern part of the sky (Northern Hemisphere), remains relatively low in the sky, and sets along the southwestern horizon after a short time above the horizon.

At the time of the autumnal equinox, the part of the ecliptic opposite the Sun is most nearly parallel to the horizon. Since the eastward motion of the Moon is

approximately along the ecliptic, the delay in the time of rising of the full Moon from night to night is less than at other times of the year. The full Moon nearest the autumnal equinox is called the **Harvest Moon**; the full Moon a month later is called the **Hunter's Moon**. See Figure 1312a for an image of the Phases of the Moon.

See Figure 1312b for a depiction of Earthrise from the surface of the moon.

1313. Comets and Meteors

Although **comets** are noted as great spectacles of nature, very few are visible without a telescope. Those that become widely visible do so because they develop long, glowing tails. Comets consist of a solid, irregularly shaped nucleus, a few kilometers across, composed of rock and ice. As the nucleus approaches the Sun in its orbit, the ice evaporates and forms an atmosphere around the nucleus, called the coma, and the tail. The tail, which may eventually extend tens of millions of kilometers or more, consists of both gas and dust; the dust reflects sunlight while the gases fluoresce. The tail is driven away from the direction of the Sun by radiation pressure and solar wind. The tail is so thin that stars can easily be seen through it.

Compared to the well-ordered orbits of the planets, comets are erratic and inconsistent. Some travel east to west and some west to east, in highly eccentric orbits inclined at any angle to the ecliptic. Periods of revolution range from



Figure 1312b. Earthrise from the surface of the Moon.
Image courtesy of NASA.

about 3 years to thousands of years. Some comets may speed away from the solar system after gaining velocity as they pass by Jupiter or Saturn.

Of the known comets in our solar system, Halley's comet is the most famous because it returns about every 75 years. Its appearance in 1910 was spectacular but its 1986 apparition was hardly noticed, especially in the northern hemisphere. It will return in 2061. Comet Hale-Bopp, easily visible from the northern hemisphere in the spring of 1997, is said to have been seen by more people than any other comet in history. Other recent bright comets include Comet Ikeya-Seki (1965), Comet West (1976), and Comet McNaught (2007), the last of which was most spectacular from the southern hemisphere.



Figure 1313. Comet Hyakutake made its closest approach to the Earth on March 25, 1996. Image courtesy of NASA.

The short-period comets long ago lost the gasses needed to form a tail. Long period comets, such as comet Hyakutake, are more likely to develop tails. See Figure 1313. The visibility of a comet depends very much on how close it approaches the Earth. Hyakutake's passage on March 25, 1996 was one of the closest cometary approaches of the previous 200 years.

The visibility of a comet depends very much on how close it approaches the Earth. In 1910, Halley's comet spread across the sky. Yet when it returned in 1986, the Earth was not well situated to get a good view, and it was barely visible to the unaided eye.

Meteors, popularly called **shooting stars**, are rocks or rock particles from space that fall toward the Earth and are heated to incandescence by air friction in the Earth's upper atmosphere. They are visible as streaks of light in the night sky that generally last no longer than a few seconds. The particles involved, called meteoroids, range in size from dust grains to boulders, with the former much more frequent than the latter. A particularly bright meteor is called a **fireball**. One that explodes is called a **bolide**. The rare meteoroid that survives its trip through the atmosphere and lands as a solid particle is called a **meteorite**.

Millions of meteors large enough to be seen enter the Earth's atmosphere each hour, and many times this number undoubtedly enter, but are too small to be seen. The cosmic dust they create constantly rains down on the Earth, tons per day. Meteors are seen more frequently in the pre-dawn hours than at other times of the night because the pre-dawn sky is on the leading side of the Earth as it moves along its orbit, where more meteoroid particles collect.

Meteor showers occur at certain times of the year when the Earth passes through **meteor swarms** (streams of meteoroid particles), the scattered remains of comets that have broken apart. At these times the number of meteors observed is many times the usual number.

A faint glow sometimes observed extending upward approximately along the ecliptic before sunrise and after sunset has been attributed to the reflection of sunlight from quantities of this material. This glow is called **zodiacal light**. A faint glow at that point of the ecliptic 180° from the Sun is called the **gegenschein** or **counterglow**.

1314. Stars

Stars are distant Suns, in many ways resembling our own. Like the Sun, stars are massive balls of gas that create their own energy through thermonuclear reactions.

Although stars differ in size and temperature, these differences are apparent only through analysis by astronomers. Some differences in color are noticeable to the unaided eye. While most stars appear white, some (those of lower temperature) have a reddish hue. Orion, blue Rigel and red Betelgeuse, located on opposite sides of the belt, constitute a noticeable contrast.

The stars are not distributed uniformly around the sky.

Stars appearing in the same area of the sky can bring to mind patterns. Ancient peoples supplied star patterns with names and myths; today we call them **constellations**. Today professional astronomers recognize 88 “modern” constellations, used to identify areas of the sky.

Under ideal viewing conditions, the dimmest star that can be seen with the unaided eye is of the sixth magnitude. In the entire sky there are about 6,000 stars of this magnitude or brighter. Half of these are below the horizon at any time. Because of the greater absorption of light near the horizon, where the path of a ray travels for a greater distance through the atmosphere, not more than perhaps 2,500 stars are visible to the unaided eye at any time. However, the average navigator seldom uses more than perhaps 20 or 30 of the brighter stars.

Stars which exhibit a noticeable change of magnitude are called **variable stars**. A star which suddenly becomes several magnitudes brighter and then gradually fades is called a **nova**. A particularly bright nova is called a **supernova**. Supernovae that are visible to the unaided eye are very rare, occurring less than once per century on average.

Two stars which appear to be very close together are called a **double star system**. They may just lie in the same direction of the sky and not be physically related to each other. If they are gravitational bound to each other, they are known as a **binary star system**. The bright star Sirius is actually one component of a binary star system; the other component is too faint to be seen without a telescope. If more than two stars are included in a group, it is called a **multiple star system**.

A group of a few dozen to several hundred stars moving through space together is called an **open cluster**. The Pleiades is an example of an open cluster. There are also spherically symmetric clusters of hundreds of thousands of stars known as **globular clusters**. The globular clusters are all too distant to be seen with the naked eye.

A cloudy patch of matter in the heavens is called a **nebula**. If it is within the galaxy of which the Sun is a part, it is called a **galactic nebula**; if outside, it is called an **extragalactic nebula**.

Motion of a star through space can be classified by its vector components. That component in the line of sight is called **radial motion**, while that component across the line of sight, causing a star to change its apparent position relative to the background of more distant stars, is called **proper motion**.

1316. Apparent Motion due to Rotation of the Earth

The **apparent motion** of the heavens arising from the Earth's rotation is much greater than other motions of celestial bodies. This motion causes celestial bodies to appear to rise along the eastern half of the horizon, climb to

1315. Galaxies

A **galaxy** is a vast collection of clusters of stars and clouds of gas. In many galaxies the stars tend to congregate in groups called **star clouds** arranged in long spiral arms. The spiral nature is believed due to matter density waves that propagate through the galaxy over time (Figure 1315).



Figure 1315. Spiral nebula Messier 51. Image courtesy of NASA.

The Earth is located in the Milky Way galaxy, a slowly spinning disk more than 100,000 light years in diameter. All the bright stars in the sky are in the Milky Way. However, the most dense portions of the galaxy are seen as the great, broad band that glows in the summer nighttime sky. When we look toward the constellation Sagittarius, we are looking toward the center of the Milky Way, 25,000 light years away.

Despite their size and luminance, almost all other galaxies are too far away to be seen with the unaided eye. An exception in the northern hemisphere is the Great Galaxy (sometimes called the Great Nebula) in Andromeda, which appears as a faint glow. In the southern hemisphere, the Large and Small Magellanic Clouds (named after Ferdinand Magellan) are the nearest known neighbors of the Milky Way. They are approximately 200,000 light years distant. The Magellanic Clouds can be seen as sizable glowing patches in the southern sky.

APPARENT MOTION

their maximum altitude as they cross the meridian, and set along the western horizon, at about the same point relative to due west as the rising point was to due east. This apparent motion of a body along the daily path, or **diurnal circle**, is approximately parallel to the plane of the equator. It would be exactly so if rotation of the Earth were the only motion

and the axis of rotation of the Earth were stationary in space.

The apparent effect due to rotation of the Earth varies with the latitude of the observer. At the equator, where the equatorial plane is perpendicular to the horizon (since the axis of rotation of the Earth is parallel to the plane of the horizon), bodies appear to rise and set vertically. Every celestial body is above the horizon approximately half the time. The celestial sphere as seen by an observer at the equator is called the right sphere, shown in Figure 1316a.

For an observer at one of the poles, bodies having constant declination neither rise nor set, remaining parallel to the horizon (neglecting precession of the equinoxes and changes in refraction). They circle the sky, always at the same altitude, making one complete trip around the horizon

each **sidereal day** (See Section 1611). At the North Pole the motion is clockwise, and at the South Pole it is counter-clockwise. Approximately half the stars are always above the horizon and the other half never are. The parallel sphere at the poles is illustrated in Figure 1316b.

Between these two extremes, the apparent motion is a combination of the two. On this oblique sphere, illustrated in Figure 1316c, circumpolar celestial bodies are those that remain above the horizon during the entire 24 hours, circling the elevated celestial pole. The portion of the sky where bodies are circumpolar extends from the elevated pole to approximately the declination equal to 90° minus the observer's latitude. For example, the stars of Ursa Major (the Big Dipper) and Cassiopeia are circumpolar for many observers in the United States.



Figure 1316a. The right sphere.

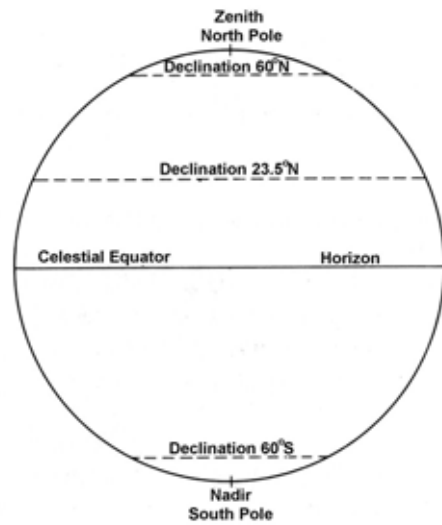

Figure 1316b. The parallel sphere.



Figure 1316c. The oblique sphere at latitude 40°N .

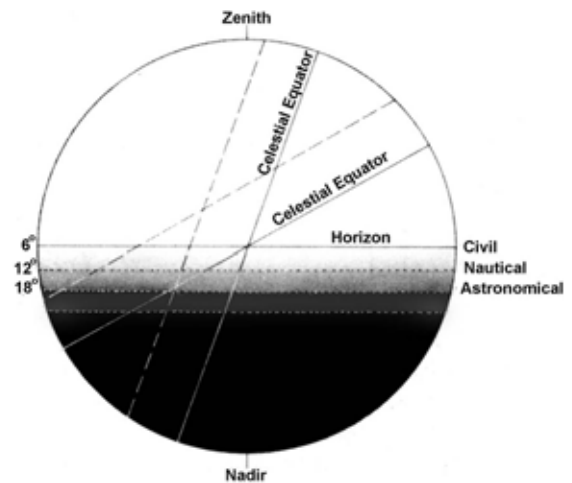

Figure 1316d. The various twilight at latitude 20°N and latitude 60°N .

An area of the celestial sphere approximately equal to

the circumpolar area around the depressed pole remains

Twilight	Lighter limit	Darker limit	At darker limit
Civil	sunrise/set	-6°	Horizon clear; bright stars visible
Nautical	-6°	-12°	Horizon not visible
Astronomical	-12°	-18°	Full night

Table 1316. Limits of the three twilights.

constantly below the horizon. For example, Crux is not visible to most observers in the United States. Other celestial bodies rise obliquely along the eastern horizon, climb to maximum altitude at the celestial meridian, and set along the western horizon. The length of time above the horizon and the altitude at meridian transit vary with both the latitude of the observer and the declination of the body. Days and nights are always about the same length in the tropics. At higher latitudes the increased obliquity result in a greater change in the length of the day and longer periods of twilight. North of the Arctic Circle and south of the Antarctic Circle the Sun is circumpolar for part of the year. This is sometimes termed the land of the midnight Sun, where the Sun does not set during part of the summer and does not rise during part of the winter.

The increased obliquity at higher latitudes explains why days and nights are always about the same length in the tropics, and the change of length of the day becomes greater as latitude increases, and why twilight lasts longer in higher latitudes. Evening twilight begins at sunset, and morning twilight ends at sunrise. The darker limit of twilight occurs when the center of the Sun is a stated number of degrees below the celestial horizon. Three kinds of twilight are defined: civil, nautical and astronomical. See Table 1316.

The conditions at the darker limit are relative and vary considerably under different atmospheric conditions.

In Figure 1316d, the twilight band is shown, with the darker limits of the various kinds indicated. The nearly vertical celestial equator line is for an observer at latitude 20°N . The nearly horizontal celestial equator line is for an observer at latitude 60°N . The broken line for each case is the diurnal circle of the Sun when its declination is 15°N . The portion of the diurnal circle between the lighter and the darker limits indicates the relative duration of a particular type of twilight at the two example latitudes. But the relative duration is not directly proportional to the relative length of line shown since the projection is orthographic. Note that complete darkness will not occur at latitude 60°N when the declination of the Sun is 15°N .

1317. Apparent Motion due to Revolution of the Earth

If it were possible to stop the rotation of the Earth so that the celestial sphere would appear stationary, the effects

of the revolution of the Earth would become more noticeable. The Sun would appear to move eastward a little less than 1° per day, to make one complete trip around the Earth in a year. If the Sun and stars were visible at the same time this motion could be observed by watching the changing position of the Sun with respect to the stars. A better way is to observe the constellations at the same time each night. Each night, a star rises nearly four minutes earlier than on the previous night. The period from star rise on one night to its rise on the next night is called a **sidereal day**. Thus, the celestial sphere appears to shift westward nearly 1° each night, so that different constellations are associated with different seasons of the year.

Apparent motions of planets and the Moon are due to a combination of their motions and those of the Earth. If the rotation of the Earth were stopped, the combined apparent motion due to the revolutions of the Earth and other bodies would be similar to that occurring if both rotation and revolution of the Earth were stopped. Stars would appear nearly stationary in the sky but would undergo a small annual cycle of change due to aberration. The motion of the Earth in its orbit is sufficiently fast to cause the light from stars to appear to shift slightly in the direction of the Earth's motion. This is similar to the effect one experiences when walking in vertically-falling rain that appears to come from ahead due to the observer's own forward motion. The apparent direction of the light ray from the star is the vector difference of the motion of light and the motion of the Earth, similar to that of apparent wind on a moving vessel. This effect is most apparent for a body perpendicular to the line of travel of the Earth in its orbit, for which it reaches a maximum value of 21.2 seconds of arc. The effect of aberration can be noted by comparing the coordinates (declination and sidereal hour angle) of various stars throughout the year. A change is observed in some bodies as the year progresses, but at the end of the year the values have returned almost to what they were at the beginning. The reason they do not return exactly is due to proper motion and precession of the equinoxes. It is also due to nutation, an irregularity in the motion of the Earth due to the disturbing effect of other celestial bodies, principally the Moon. Polar motion is a slight wobbling of the Earth about its axis of rotation and sometimes wandering of the poles. This motion, which does not exceed 40 feet from the mean position, produces slight variation of latitude and longitude of places on

the Earth.

1318. Apparent Motion due to Movement of other Celestial Bodies

Each celestial body makes its own contribution to its apparent motion:

The Moon revolves about the Earth each month, rising in the west and setting in the east. Its orbital plane is slightly inclined to the ecliptic (see Section 1319), and is continuously changing in response to perturbations in its motion, primarily by the Sun.

The planets revolve about the Sun (technically, the solar system barycenter, which is within the sun's interior). The inferior planets, Mercury and Venus, appear to move eastward and westward relative to the Sun. The period for Mercury's motion is 116 days and the period for Venus is 584 days (see Section 1310). The superior planets make an apparent revolution around the Earth, from west to east. The periods for their motion varies from 780 to 367 days, depending on the planet (see Section 1311).

The stars revolve about the galactic center. As they move about the galactic center, the stars, including the Sun, move with respect to one another. The component of their motion across the line of sight is called proper motion. The maximum observed proper motion is that of Barnard's Star, which is moving at the rate of 10.3 seconds of arc per year. Barnard's Star is a tenth-magnitude star, not visible to the unaided eye. Rigil Kentaurus has the greatest proper motion of the 57 stars listed on the daily pages of the almanacs, about 3.7 seconds per year. Arcturus has the greatest proper motion of the navigational stars in the Northern Hemisphere, 2.3 seconds per year. Over the course of a few years, proper motions are very small; they can be ignored when reducing celestial navigation sights. A few thousand years of proper motion is sufficient to materially alter the look of some familiar constellations.

1319. The Ecliptic and the Inclination of the Earth's Axis

The **ecliptic** is the mean path of the Sun through the heavens arising from the annual revolution of the Earth in its orbit and appears as a great circle on the celestial sphere. The ecliptic is currently inclined at an angle of about $23^{\circ}26'$ to the celestial equator. This angle is called the **obliquity of the ecliptic** and is due to the inclination or tilt of Earth's rotational axis relative to its orbital plane. The perturbations of the other planets on the Earth's orbital plane decreases the obliquity of the ecliptic by about $2/3$ of an arc minute per century. The obliquity of the ecliptic causes the Sun to appear to move north and south over the course of the year, giving the Earth its seasons and changing lengths of periods of daylight.

Refer to Figure 1319a. The **vernal equinox** occurs when the center of the Sun crosses the equator going north.

It occurs on or about March 21, and is the start of astronomical spring in the northern hemisphere. At this time the Sun is rising at the North Pole and setting at the South Pole, the Sun shines equally on both hemispheres, and day and night are approximately the same length over the entire world. The **summer solstice** occurs on or about June 21. On this date, the northern pole of the Earth's axis is tilted toward the Sun. The north polar regions are continuously in sunlight; the Northern Hemisphere is having its summer with long, warm days and short nights; the Southern Hemisphere is having winter with short days and long, cold nights; and the south polar region is in continuous darkness. The **autumnal equinox** occurs on or about September 23. On this date, the Sun is setting at the North Pole and rising at the South Pole, the Sun again shines equally on both hemispheres, and day and night are approximately the same length over the entire world. The **winter solstice** occurs on or about December 22. On this date, the Southern Hemisphere is tilted toward the Sun and conditions are the reverse of those six months earlier; the Northern Hemisphere is having its winter, and the Southern Hemisphere its summer.

The word **equinox** means "equal nights". At the equinoxes, the Sun is directly over the equator. It remains above the horizon for approximately 12 hours. The length of daylight is not exactly 12 hours because of refraction, the solar semidiameter, and the height of the eye of the observer. These cause the Sun to be above the horizon a few minutes longer than below the horizon. Following the **vernal equinox**, the Sun's declination increases (becomes more northerly), and the Sun climbs higher in the sky each day (at the latitudes of the United States), until the summer solstice, when a declination of about $23^{\circ}26'$ north of the celestial equator is reached. The word **solstice**, meaning "Sun stands still," is used because the Sun halts its apparent northward or southward motion and momentarily "stands still" before it starts in the opposite direction. This action, somewhat analogous to the "stand" of the tide, refers to the motion in a north-south direction, not to the daily apparent revolution around the Earth.

Over the course of a year the distance between the Earth and the Sun changes by about 1.7%. The Earth is closest to the Sun during the northern hemisphere winter. To conserve angular momentum, the Earth travels faster when nearest the Sun, like a spinning ice skater pulling her arms in. As a result, the northern hemisphere (astronomical) winter is shorter than its summer by about seven days.

The distance between the Earth and Sun is not the primary source for the difference in temperature during the different seasons. Over a year, the change in Earth-Sun distance changes the solar energy flux only 3% from the average value. The tilt of the Earth's axis has a much larger affect. During the summer the rays are more nearly vertical, and hence more concentrated, as shown in Figure 1319b. At the polar circle on the summer solstice for a hemisphere, the solar flux (energy per unit area per unit time) is 73% of the flux at the tropic where the Sun is directly overhead. Winter

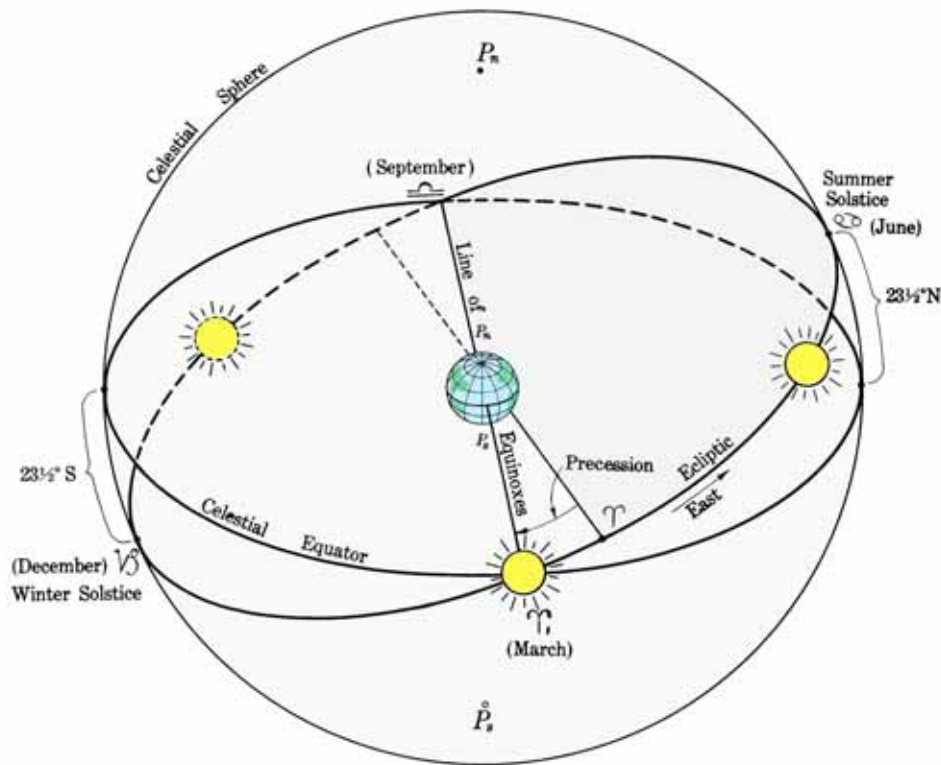

Figure 1319a. Apparent motion of the Sun in the ecliptic.

sunlight is distributed over a larger area and shines fewer hours each day, causing less total heat energy to reach the Earth. The solar flux at the polar circle on the winter solstice is nearly zero and the flux at the tropic is only 69% of the flux at the summer solstice.

Astronomically, the seasons begin at the equinoxes and solstices. Meteorologically, they differ from place to place. During the summer the Sun is above the horizon more than half the time. So, the total energy being added by absorption during a longer period than it is being lost by radiation. Following the summer solstice, the surface at a given latitude continues to receive more energy than it dissipates, but a decreasing amount. Gradually, the amount decreases until the surface is losing more energy than it gains from the Sun. This effect explains the lag of the seasons. It is analogous to the day, when the highest temperatures normally occur several hours after the Sun reaches maximum altitude at local noon.

At some time during the year, the Sun is directly overhead everywhere between the latitudes of about $23^{\circ}26'N$ and about $23^{\circ}26'S$. Except at the limits, this occurs twice: once as the Sun appears to move northward, and the second time as it moves southward. The area on Earth between these latitudes is called the Tropics, or the **torrid zone**. The northern limit is the **Tropic of Cancer**, and the southern limit is the **Tropic of Capricorn**. These names come from the constellations the Sun entered at the solstices when the names were first used more than 2,000

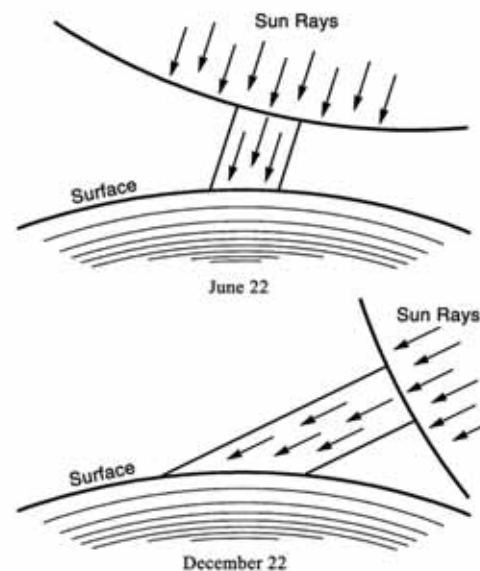

Figure 1319b. Sunlight in summer and winter. Winter sunlight is distributed over a larger area and shines fewer hours each day, causing less heat energy to reach the Earth.

years ago. Today, the Sun is in the next constellation to the

west because of precession of the equinoxes. The parallels about $23^{\circ}26'$ from the poles, marking the approximate limits of the circumpolar Sun, are called **polar circles**. The polar circle in the Northern Hemisphere is called the **Arctic Circle**, and the one in the Southern Hemisphere is called the **Antarctic Circle**. The areas inside the polar circles are the north and south **frigid zones**. The regions between the frigid zones and the torrid zones are the north and south **temperate zones**.

The expression “**vernal equinox**” and associated expressions are applied both to the times and points of occurrence of these phenomena. The vernal equinox is also called the **first point of Aries** (symbol Υ) because, when the name was given, the Sun entered the constellation Aries, the ram, as the Sun crossed the equator going north. The vernal equinox is of interest to navigators because it is the origin for measuring **sidereal hour angle**. The terms March equinox, June solstice, September equinox, and December solstice are occasionally applied as appropriate, because the more common names are associated with the seasons in the Northern Hemisphere and are six months out of step for the Southern Hemisphere.

1320. Precession and Nutation

The Earth's axis precesses: the motion of its rotation axis is similar to that of a top spinning with its axis tilted. The precession is in response to torques principally by the Sun and Moon. The spinning Earth responds to these torques in the manner of a gyroscope. The result is a slow westward movement of the equinoxes and solstices. This westward motion of the equinoxes along the ecliptic is called precession of the equinoxes. The precession has a period of about 25,800 years. There are also a series of short period motions of the Earth's axis of rotation called nutation. See Figure 1320. The nutations are all quite small. The largest nutation has an amplitude of 0.2 and a period of 18.6 years. The next largest nutation has an amplitude of just 0.01 and a period of 0.5 years.

The sidereal hour angle is measured from the vernal equinox, and declination from the celestial equator, so the coordinates of celestial bodies change because of precession. The total motion with respect to the ecliptic, called general precession, is about $50.''29$ per year. It may be divided into two components with respect to the celestial equator: precession in right ascension (about $46.''12$ per year) measured along the celestial equator, and precession in declination (about $20.''04$ per year) measured perpendicular to the celestial equator. The annual change in the coordinates of any given star, due to precession alone, depends upon its position on the celestial sphere.

Since precession changes the direction of Earth's pole, Polaris will not always be Earth's “Pole Star”. Currently, the north celestial pole is moving closer to Polaris because of precession. It will pass at a distance of approximately $28'$ about the year 2102. Afterward, the polar distance will in-

crease, and eventually other stars, in their turn, will become the Pole Star.

1321. The Zodiac

The **zodiac** is a circular band of the sky extending 8° on each side of the ecliptic. The navigational planets and the Moon are within these limits. The zodiac is divided into 12 sections of 30° each, each section being given the name and symbol (“sign”) of a constellation. These are shown in Figure 1321. The names were assigned more than 2,000 years ago, when the Sun entered Aries at the vernal equinox, Cancer at the summer solstice, Libra at the autumnal equinox, and Capricornus at the winter solstice. Because of precession, the zodiacal signs have shifted with respect to the constellations. Thus at the time of the vernal equinox, the Sun is said to be at the “first point of Aries,” though it is in the constellation Pisces.

1322. Time and the Calendar

Traditionally, astronomy has furnished the basis for measurement of time, a subject of primary importance to the navigator. The **year** is associated with the revolution of the Earth in its orbit. The **day** is one rotation of the Earth about its axis.

The duration of one rotation of the Earth depends upon the external reference point used, the most common is using the Sun. One rotation relative to the Sun is called a **solar day**. However, an actual solar day varies in length. This variation is removed by using a “fictitious **mean**” Sun, leading to what we refer to as “**mean time**.” See Chapter 16 - Time for a more complete discussion; Section 1600 discusses apparent and mean solar time.

Universal Time (UT) is a generic reference to one (of several) time scales that approximate the mean diurnal motion of the Sun. Loosely, UT is mean solar time on the Greenwich meridian. The terms “Universal Time” and “**Greenwich Mean Time**” are sometimes used interchangeably, but the latter is being deprecated. Universal Time is the standard in the application of astronomy to navigation. See Chapter 16 - Section 1602 for a more complete discussion.

If the vernal equinox is used as the reference, a **sidereal day** is obtained, and from it, **sidereal time**. This indicates the approximate positions of the stars, and for this reason it is the basis of star charts and star finders. Because of the revolution of the Earth around the Sun, a sidereal day is about 3 minutes 56 seconds shorter than a solar day, and there is one more sidereal than solar days in a year. One mean solar day equals 1.00273791 mean sidereal days. Because of precession of the equinoxes, one rotation of the Earth with respect to the stars is not quite the same as one rotation with respect to the vernal equinox. One mean solar day averages 1.0027378118868 rotations of the Earth with respect to the stars.

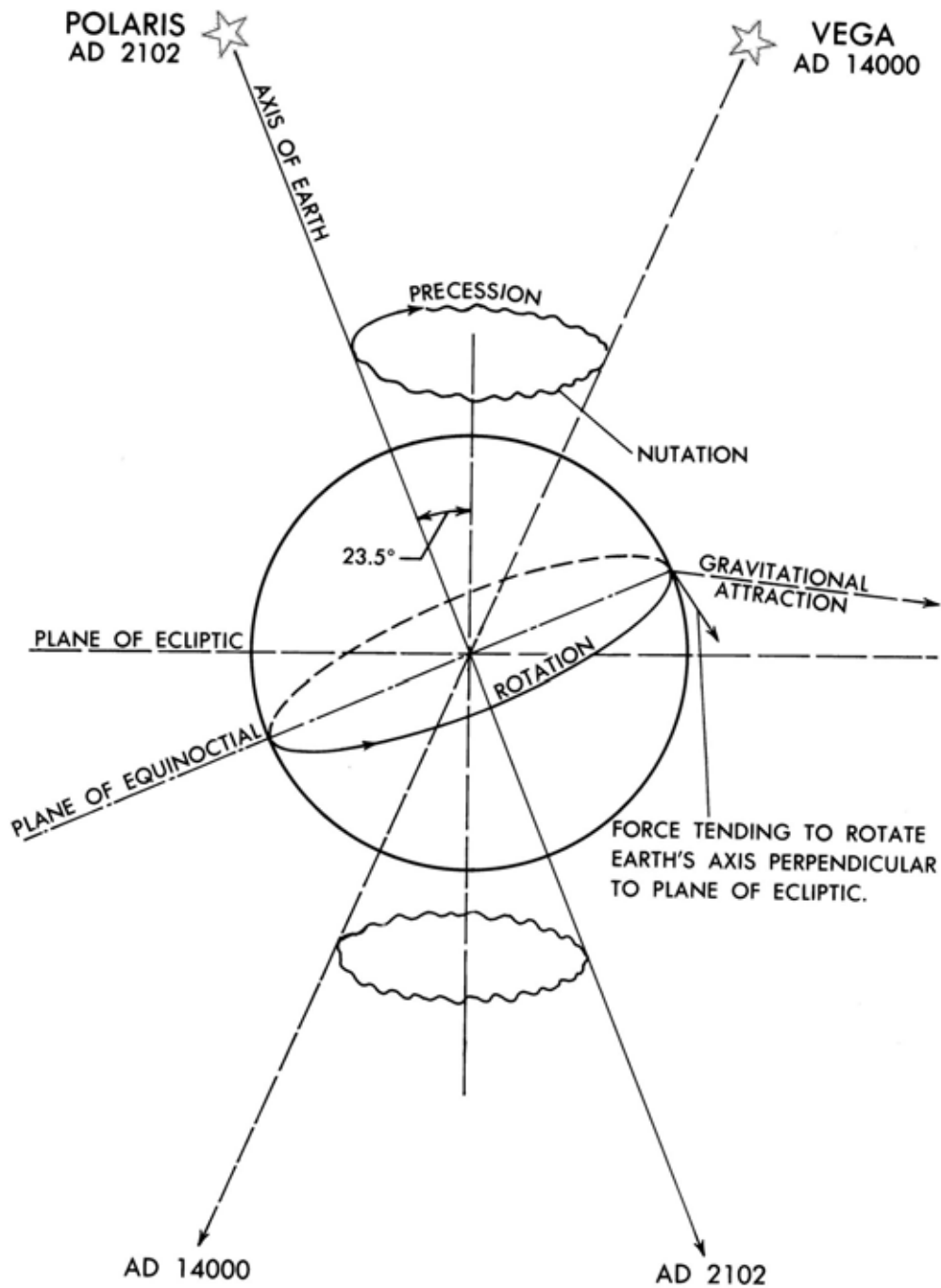

Figure 1320. Precession and nutation.

In tide analysis, the Moon is sometimes used as the reference, producing a **lunar day** averaging 24 hours 50 minutes (mean solar units) in length, and lunar time.

Since each kind of day is divided arbitrarily into 24 hours, each hour having 60 minutes of 60 seconds, the length of each of these units differs somewhat in the various kinds of time.

Time is also classified according to the terrestrial

meridian used as a reference. **Local time** results if one's own meridian is used, **zone time** if a nearby reference meridian is used over a spread of longitudes, and **Greenwich** or **Universal Time** if the Greenwich meridian is used.

The period from one vernal equinox to the next (the cycle of the seasons) is known as the **tropical year**. It is approximately 365 days, 5 hours, 48 minutes, 45 seconds,

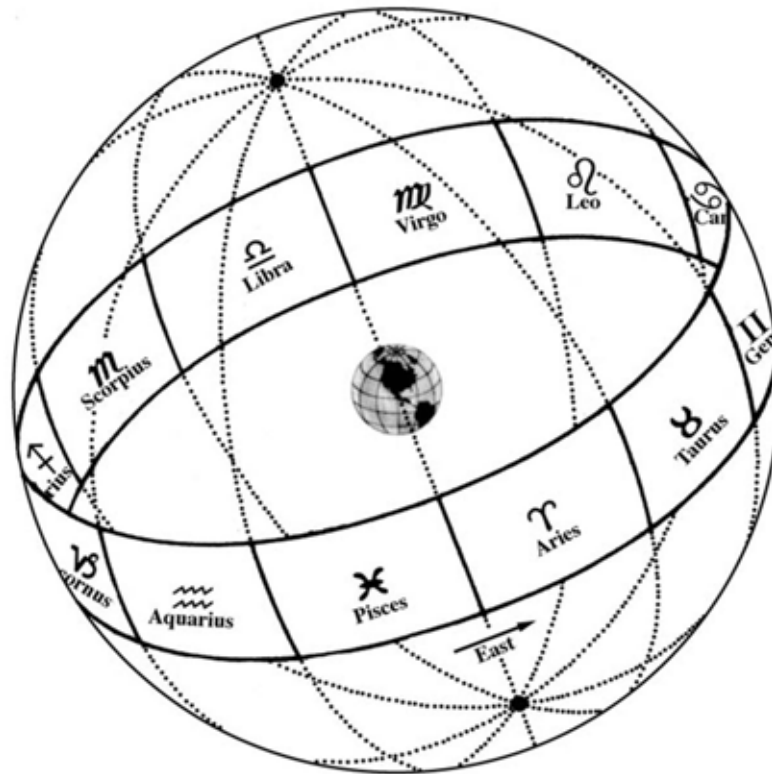

Figure 1321. The Zodiac.

though the length has been slowly changing for many centuries. Our calendar, the **Gregorian calendar**, approximates the tropical year with a combination of common years of 365 days and leap years of 366 days. A **leap year** is any year divisible by four, unless it is a century year, which must be divisible by 400 to be a leap year. Thus, 1700, 1800, and 1900 were not leap years, but 2000 was. A critical mistake was made by John Hamilton Moore in calling 1800 a leap year, causing an error in the tables in his book, *The Practical Navigator*. This error caused the loss of at least one ship and was later discovered by Nathaniel Bowditch while writing the first edition of *The New American Practical Navigator*.

See Chapter 16 for an in-depth discussion of time.

1323. Eclipses

If the orbit of the Moon coincided with the plane of the ecliptic, the Moon would pass in front of the Sun at every new Moon, causing a solar eclipse. At full Moon, the Moon would pass through the Earth's shadow, causing a lunar eclipse. Because of the Moon's orbit is inclined 5° with respect to the ecliptic, the Moon usually passes above or below the Sun at new Moon and above or below the Earth's shadow at full Moon. However, there are two points at which the plane of the Moon's orbit intersects the ecliptic. These are the **nodes** of the Moon's orbit. If the Moon passes

one of these points at the same time as the Sun, a **solar eclipse** takes place. This is shown in Figure 1323.

The Sun and Moon are of nearly the same apparent size to an observer on the Earth. If the Moon is near perigee (the point in its orbit closest to the Earth), the Moon's apparent diameter is larger than that of the Sun, and its umbra (darkest part of the shadow) reaches the Earth as a nearly round dot. The dot moves rapidly across the Earth, from west to east, as the Moon continues in its orbit. Within the dot, the Sun is completely hidden from view, and a **total eclipse** of the Sun occurs. The width of this dot on the Earth's surface varies from eclipse to eclipse, but can be as large as a couple hundred miles. On the **path of totality**, a **partial eclipse** occurs as the disk of the Moon appears to move slowly across the face of the Sun, hiding an ever-increasing part of it, until the total eclipse occurs. Because of the uneven edge of the mountainous Moon, the light is not cut off evenly. But several last illuminated portions appear through the Moon's valleys or passes between the Moon's mountain peaks. These are called **Baily's Beads**. For a considerable distance around the umbral shadow, part of the surface of the Sun is obscured, and a partial eclipse occurs.

A total eclipse is a spectacular phenomenon. As the last light from the Sun is cut off, the solar **corona**, or envelope of thin, illuminated gas around the Sun becomes visible. Wisps of more dense gas may appear as **solar prominenc-**

es. The only light reaching the observer is that diffused by the atmosphere surrounding the shadow. As the Moon appears to continue on across the face of the Sun, the Sun finally emerges from the other side, first as Baily's Beads, and then as an ever widening crescent until no part of its surface is obscured by the Moon.

The duration of a total eclipse depends upon how nearly the Moon crosses the center of the Sun, the location of the shadow on the Earth, the relative orbital speeds of the Moon and Earth, and (principally) the relative apparent diameters of the Sun and Moon. The maximum length that can occur is a little more than seven minutes.

If the Moon is near apogee, its apparent diameter is less than that of the Sun, and its shadow does not quite reach the Earth. Over a small area of the Earth directly in line with the

Moon and Sun, the Moon appears as a black disk almost covering the surface of the Sun, but with a thin ring of the Sun around its edge. This is known as an **annular eclipse**; these occur a little more often than total eclipses.

If the **umbral shadow** of the Moon passes close to the Earth, but not directly in line with it, a partial eclipse may occur without a total or annular eclipse.

An eclipse of the Moon (or **lunar eclipse**) occurs when the Moon passes through the shadow of the Earth, as shown in Figure 1323. Since the diameter of the Earth is about $3\frac{1}{2}$ times that of the Moon, the Earth's shadow at the distance of the Moon is much larger than that of the Moon. A total eclipse of the Moon can last nearly $1\frac{3}{4}$ hours, and some part of the Moon may be in the Earth's shadow for almost 4 hours.

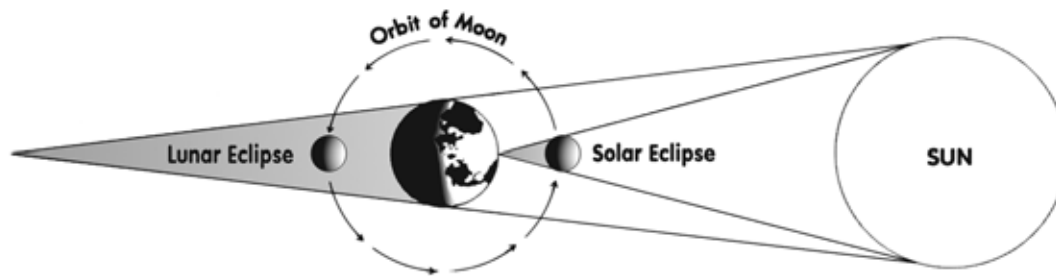

Figure 1323. Eclipses of the Sun and Moon.

During a total solar eclipse no part of the Sun is visible because the Moon is in the line of sight. But during a lunar eclipse some light does reach the Moon, diffracted by the atmosphere of the Earth, and hence the eclipsed full Moon is visible as a faint reddish disk. A lunar eclipse is visible over the entire hemisphere of the Earth facing the Moon. Anyone who can see the Moon can see the eclipse.

During any one year there may be as many as five eclipses of the Sun, and always there are at least two. There may be as many as three eclipses of the Moon, or none. The total number of eclipses during a single year does not exceed seven, and can be as few as two. There are more solar than

lunar eclipses, but the latter can be seen more often because of the restricted areas over which solar eclipses are visible.

The Sun, Earth, and Moon are nearly aligned on **the line of nodes** twice each "eclipse year" of 346.6 days. This is less than a calendar year because of **regression of the nodes**. In a little more than 18 years the line of nodes returns to approximately the same position with respect to the Sun, Earth, and Moon. During an almost equal period, called the **saros**, a cycle of eclipses occurs. During the following saros the cycle is repeated with only minor differences.

COORDINATES

1324. Latitude and Longitude

Latitude and longitude are coordinates used to locate positions on the Earth. This section discusses three different definitions of these coordinates.

Astronomic latitude is the angle (ABQ, Figure 1324) between a line in the direction of gravity (AB) at a station and the plane of the equator (QQ'). **Astronomic longitude** is the angle between the plane of the celestial meridian at a station and the plane of the celestial meridian at Greenwich. These coordinates are customarily found by means of celestial observations. If the Earth were perfectly homogeneous and round, these positions would be consistent and satisfac-

tory. However, because of deflection of the vertical due to uneven distribution of the mass of the Earth, lines of equal astronomic latitude and longitude are not circles, although the irregularities are small. In the United States the east-west component of the deflection of the vertical (affecting longitude) may be a little more than 18", and the north-south component (affecting latitude) may be as much as 25".

Geodetic latitude is the angle (ACQ, Figure 1324) between a normal to the spheroid (AC) at a station and the plane of the geodetic equator (QQ'). **Geodetic longitude** is the angle between the plane defined by the normal to the spheroid and the axis of the Earth and the plane of the geo-

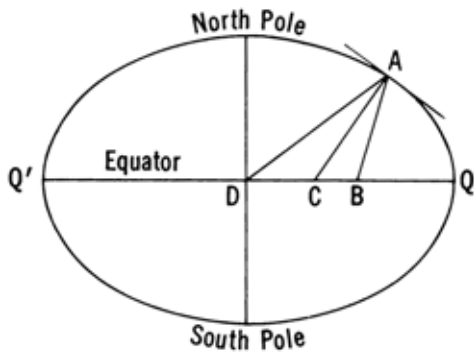

Figure 1324. Three kinds of latitude at point A.

etic meridian at Greenwich. These values are obtained when astronomical latitude and longitude are corrected for deflection of the vertical. These coordinates are used for charting and are frequently referred to as **geographic lati-**

tude and **geographic longitude**, although these expressions are sometimes used to refer to astronomical latitude.

Geocentric latitude is the angle (ADQ, Figure 1324) at the center of the ellipsoid between the plane of its equator (QQ') and a straight line (AD) to a point on the surface of the Earth. This differs from geodetic latitude because the Earth is a spheroid rather than a sphere, and the meridians are ellipses. Since the parallels of latitude are considered to be circles, geodetic longitude is geocentric, and a separate expression is not used. The difference between geocentric and geodetic latitudes is a maximum of about 11.6' at latitude 45°.

Because of the oblate shape of the ellipsoid, the length of a degree of geodetic latitude is not everywhere the same, increasing from about 59.7 nautical miles at the equator to about 60.3 nautical miles at the poles. The value of 60 nautical miles customarily used by the navigator is correct at about latitude 45°.

MEASUREMENTS ON THE CELESTIAL SPHERE

1325. Elements of the Celestial Sphere

The **celestial sphere** (Section 1301) is an imaginary sphere of infinite radius with the Earth at its center (Figure 1325a). The north and south celestial poles of this sphere, PN and PS respectively, are located by extension of the Earth's mean pole of rotation. The **celestial equator** (sometimes called **equinoctial**) is the projection of the plane of the Earth's equator to the celestial sphere. A **celestial meridian** is a great circle passing through the celestial poles and the zenith of any location on the Earth.

The point on the celestial sphere vertically overhead of an observer is the **zenith**, and the point on the opposite side of the sphere vertically below him or her is the **nadir**. The zenith and nadir are the extremities of a diameter of the celestial sphere through the observer and the common center of the Earth and the celestial sphere. The arc of a celestial meridian between the poles is called the **upper branch** if it contains the zenith and the **lower branch** if it contains the nadir. The upper branch is frequently used in navigation, and references to a celestial meridian are understood to mean only its upper branch unless otherwise stated.

In order to uniquely define every point on the celestial sphere, a coordinate system must be defined. One such coordinate system uses **hour angles** and **declination**. With these two angular measurements, every position on the celestial sphere can be uniquely described.

Hour circles are great circles on the celestial sphere that pass through the celestial poles, and are therefore perpendicular to the **celestial equator**. An **hour angle** is the angle from a "reference" hour circle to the hour circle of a point (or object). There are three main "reference" hour circles used in celestial navigation. The first is the hour circle

through the **vernal equinox** (also known as the **first point of Aries** (Υ)). The angular distance west of this reference circle is called the **sidereal hour angle** (SHA) (Figure 1325b). The second is using the local meridian as the reference hour circle. The angular distance west of the local meridian is known as a **local hour angle** (LHA). And the third reference is the Greenwich meridian. Measurements west from the Greenwich meridian are known as **Greenwich hour angles**, or GHA. See Figure 1325c for a depiction of how to locate a point on the celestial sphere.

Since hour circles are perpendicular to the celestial equator, hour angles can be thought of as angular measurements along the equator. This give us one of our two coordinates needed to define every point on the celestial sphere. The second coordinate, **declination**, is the angular distance from the celestial equator along an hour circle and is measured north or south of the celestial equator in degrees, from 0° through 90°, similar to latitude on the Earth. Northern and southern declinations are sometime labeled with positive or negative values, respectively if not labeled N or S. A circle parallel to the celestial equator is called a **parallel of declination**, since it connects all points of equal declination. It is similar to a parallel of latitude on the Earth.

It is sometimes more convenient to measure hour angle either eastward or westward, as longitude is measured on the Earth, in which case it is called **meridian angle** (designated "t").

A point on the celestial sphere may also be located using **altitude** and **azimuth**, which are topocentric coordinates based upon the observer's local horizon as the primary great circle instead of the celestial equator.

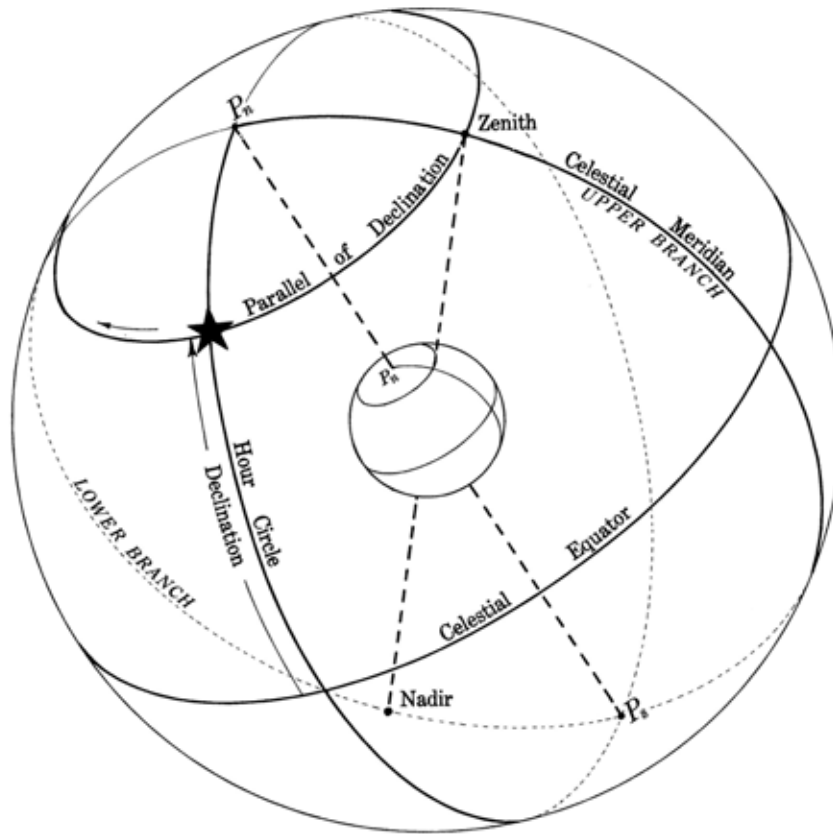

Figure 1325a. Elements of the celestial sphere can be located by its sidereal hour angle.

COORDINATE SYSTEMS

1326. The Celestial Equator System of Coordinates

The familiar graticule of latitude and longitude lines, expanded until it reaches the celestial sphere, forms the basis of the **celestial equator system** of coordinates. On the celestial sphere latitude becomes **declination**, while longitude becomes **sidereal hour angle**, measured from the **vernal equinox**.

Polar distance (p) is angular distance from a celestial pole, or the arc of an hour circle between the celestial pole and a point on the celestial sphere. It is measured along an hour circle and may vary from 0° to 180° , since either pole may be used as the origin of measurement. It is usually considered the complement of declination, though it may be either $90^\circ - d$ or $90^\circ + d$, depending upon the pole used. See Figure 1326a.

Local hour angle (LHA) is angular distance west of the local celestial meridian, or the arc of the celestial equator between the upper branch of the local celestial meridian and the hour circle through a point on the celestial sphere, measured westward from the local celestial meridian, through 360° . It is

also the similar arc of the parallel of declination and the angle at the celestial pole, similarly measured. If the Greenwich (0°) meridian is used as the reference, instead of the local meridian, the expression **Greenwich hour angle (GHA)** is applied. It is sometimes convenient to measure the arc or angle in either an easterly or westerly direction from the local meridian, through 180° , when it is called **meridian angle (t)** and labeled E or W to indicate the direction of measurement. All bodies or other points having the same hour angle lie along the same hour circle.

Because of the apparent daily rotation of the celestial sphere, the hour angle of an object continually increases, but meridian angle increases from 0° at the celestial meridian to 180° W, which is also 180° E, and then decreases to 0° again. The rate of change in meridian angle for the mean Sun is 15° per hour. The rate of all other bodies except the Moon is within $3'$ of this value. The average rate of the Moon is about 15.5° .

As the celestial sphere rotates, each body crosses each branch of the celestial meridian approximately once a day. This crossing is called **meridian transit** (sometimes called

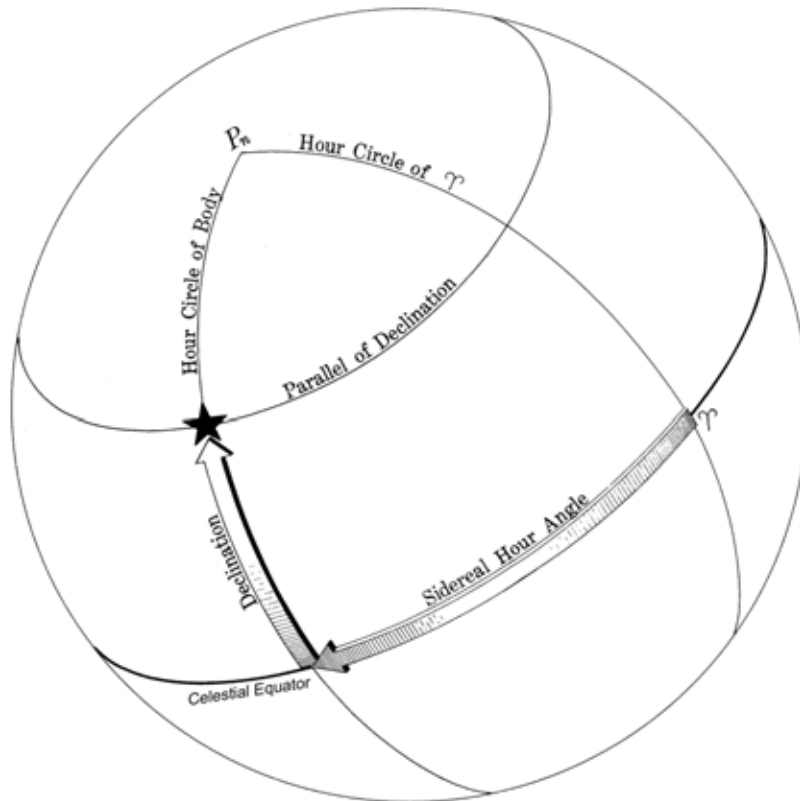

Figure 1325b. A point on the celestial sphere can be located by its declination and sidereal hour angle.

culmination). For circumpolar bodies, it is called **upper transit** to indicate crossing the upper branch of the meridian and **lower transit** to indicate crossing the lower branch.

The **time diagram** shown in Figure 1326b illustrates the relationship between the various hour angles and meridian angle. The circle is the celestial equator as seen from above the South Pole, with the upper branch of the observer's meridian (P_sM) at the top. The radius P_sG is the Greenwich meridian; $P_s \Upsilon$ is the hour circle of the vernal equinox. The Sun's hour circle is to the east of the observer's meridian; the Moon's hour circle is to the west of the observer's meridian. Note that when LHA is less than 180° , it is numerically the same and is labeled W, but that when LHA is greater than 180° , $t = 360^\circ - \text{LHA}$ and is labeled E. In Figure 1326b arc GM is the longitude, which in this case is west. The relationships shown apply equally to other arrangements of radii, except for relative magnitudes of the quantities involved.

1327. Atmospheric Refraction of Light

The Earth's atmosphere acts like a lens which causes light rays to bend. This bending of a light ray or path is called **refraction**. The amount of the angular change caused by refraction is primarily a function of the atmospheric density gradient. An incoming light ray is bent or

refracted towards the direction of increasing atmospheric density. The apparent path of the refracted light ray is always closer to perpendicular to the atmospheric density gradient than the path of the unrefracted ray. A light ray approaching the observer from the zenith is perpendicular to the density gradient. So, the refraction angle for the zenith is 0, and the direction of the refraction angle for other light rays is towards the zenith, making an object appear higher than if it were not refracted. In other words, an object's observed altitude is increased due to refraction. The greatest angular change occurs near the horizon where the light path is almost parallel to a given atmospheric density layer. The mean refraction angle near the horizon is approximately $34'$. The density gradient and refraction angle are a function of the atmospheric pressure and temperature. So, observations made near the horizon should be corrected for changes from the standard pressure (1010 mb) and temperature (10°C) used in calculating the refraction.

1328. The Horizons

The second set of celestial coordinates with which the navigator is directly concerned is based upon the horizon as the primary great circle. However, since several different horizons are defined, these should be thoroughly understood before proceeding with a consideration of the

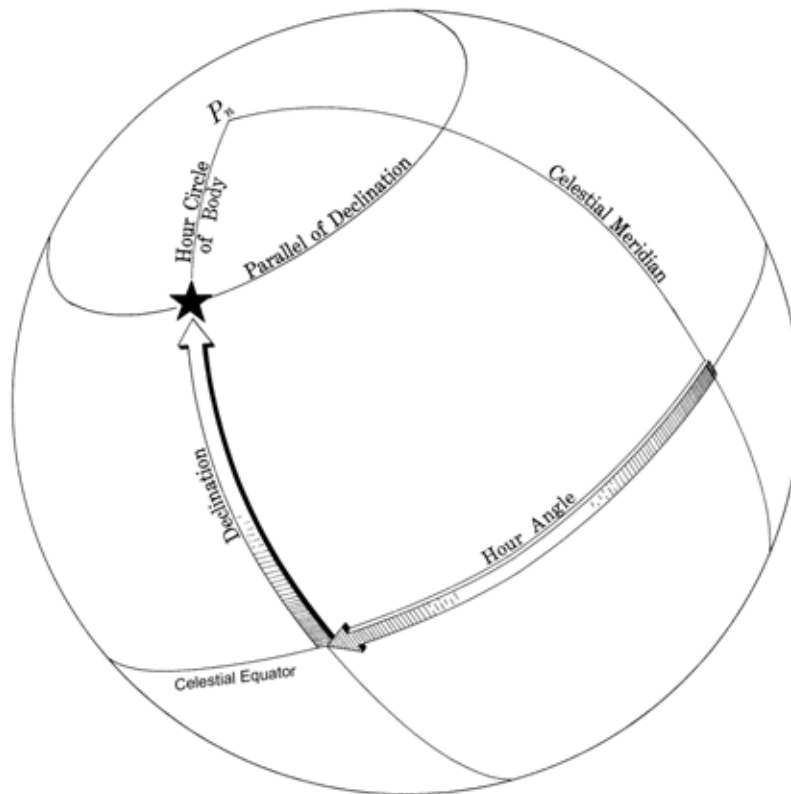

Figure 1325c. A point on the celestial sphere can be located by its declination and hour angle.

horizon system of coordinates.

The line where Earth and sky appear to meet is called the **visible** or **apparent horizon**. On land this is usually an irregular line unless the terrain is level. At sea the visible horizon appears very regular and is often very sharp. However, its position relative to the celestial sphere depends primarily upon (1) the refractive index of the air and (2) the height of the observer's eye above the surface.

In Figure 1328, the observer's eye is a height h above the Earth at A. The line through A and the center of the Earth is the vertical of the observer and contains the zenith. The plane perpendicular to the vertical is the **sensible horizon**. If the observer is at the Earth's surface, $h = 0$, then the plane of the sensible horizon is called the **geoidal horizon**. And if the observer is at the center of the Earth, then the plane of the sensible horizon is called the **celestial horizon**. The radius of the Earth is negligible with respect to that of the celestial sphere. Most measurements are referred only to the celestial horizon.

If the eye of the observer is at the surface of the Earth, the sensible horizon coincides with the geoidal horizon; but above the Earth's surface, at height h , the observer's eye is at the vertex of a cone, which is tangent to the Earth at the geometric horizon. The angle between the sensible and geometric horizon is the **geometric dip**. So, it is possible to

observe a body, which is above the geometric horizon but below the celestial horizon. That is, the body's altitude is negative and its zenith distance is greater than 90° .

The apparent (or visible) horizon, that is the horizon seen by the observer, is not identical to the geometric horizon because of the refraction of light by the atmosphere. The direction of refraction is towards the zenith, so the apparent horizon is above the geometric horizon. However, because the path of the light is bent the position of the apparent horizon, the place on the Earth's surface where the light path is tangent to the surface, is farther away than the geometric horizon. The difference between the geometric dip and the refraction angle is the **total dip**.

1329. The Horizon System of Coordinates

This system is based upon the celestial horizon as the primary great circle and a series of secondary vertical circles which are great circles through the zenith and nadir of the observer and hence perpendicular to his or her horizon (Figure 1329a). Thus, the celestial horizon is similar to the equator, and the vertical circles are similar to meridians, but with one important difference. The celestial horizon and vertical circles are dependent upon the position of the observer and hence move with changes position, while the

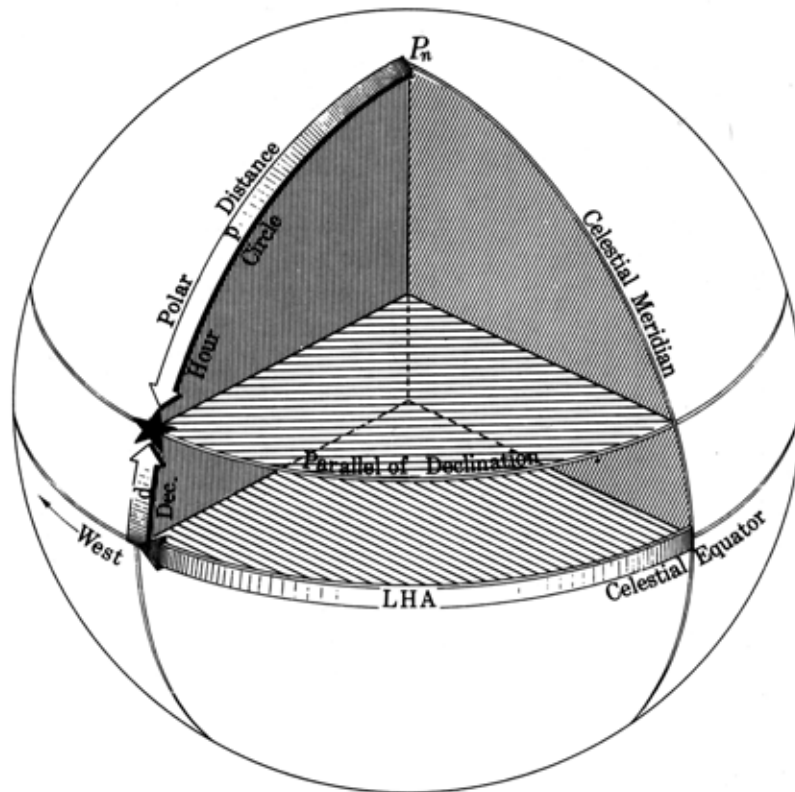

Figure 1326a. The celestial equator system of coordinates, showing measurements of declination, polar distance, and local hour angle.

primary and secondary great circles of both the geographical and celestial equator systems are independent of the observer. The horizon and celestial equator systems coincide for an observer at the geographical pole of the Earth and are mutually perpendicular for an observer on the equator. At all other places the two are oblique.

The **celestial** or **local meridian** passes through the observer's zenith, nadir, and poles of the celestial equator system of coordinates. As such, it passes through north and

As shown in Figure 1329b, altitude is angular distance above the horizon. It is measured along a vertical circle, from 0° at the horizon through 90° at the zenith. Altitude measured from the visible horizon may exceed 90° because of the dip of the horizon, as shown in Figure 1329a. Altitude is nominally a positive value, however, angular distance below the celestial horizon, called negative altitude, is provided for by including certain negative altitudes in some tables for use in celestial navigation. All points having the same altitude lie along a parallel of altitude.

Zenith distance (z) is angular distance from the zenith, or the arc of a vertical circle between the zenith and a point on the celestial sphere. It is measured along a vertical circle from 0° through 180° . It is usually considered the complement of altitude. For a body measured with respect to the

south on the observer's horizon. One of these poles (having the same name, N or S, as the latitude) is above the horizon and is called the **elevated pole**. The other, called the **depressed pole**, is below the horizon. In the horizon system it is called the principal vertical circle. The vertical circle through the east and west points of the horizon, and hence perpendicular to the principal vertical circle, is called the **prime vertical circle**, or simply the **prime vertical**.
celestial horizon $z = 90^\circ - h$.

The horizontal direction of a point on the celestial sphere, or the bearing of the geographical position, is called **azimuth** or **azimuth angle** depending upon the method of measurement. In both methods it is an arc of the horizon (or parallel of altitude). It is true azimuth (Z_n) if measured east from north on the horizon through 360° , and azimuth angle (Z) if measured either direction along the horizon through 180° , starting at the north for an observer in north latitudes and the south in south latitudes.

1330. The Ecliptic System of Coordinates

The **ecliptic system** is based upon the ecliptic as the primary great circle, analogous to the equator. The **ecliptic**

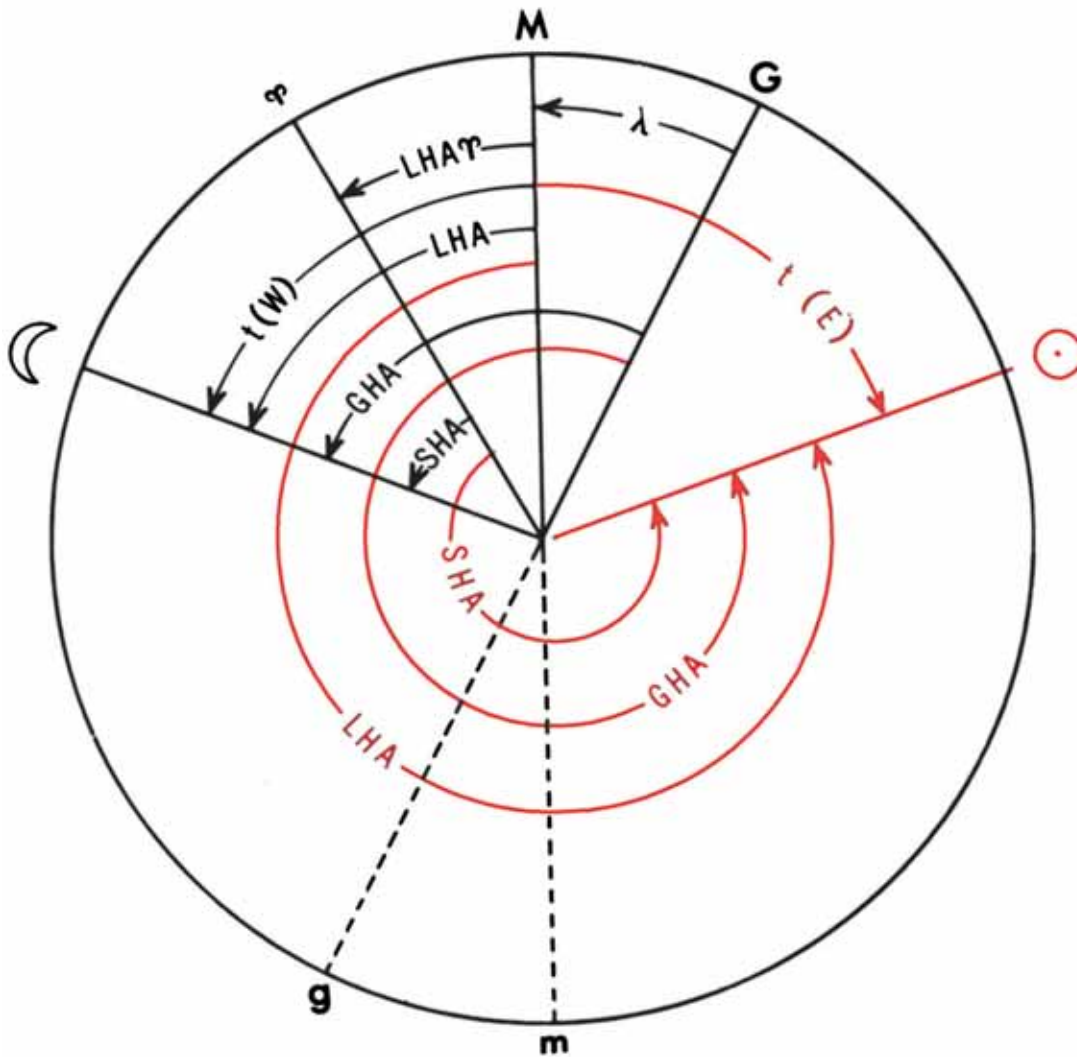

Figure 1326b. Time diagram.

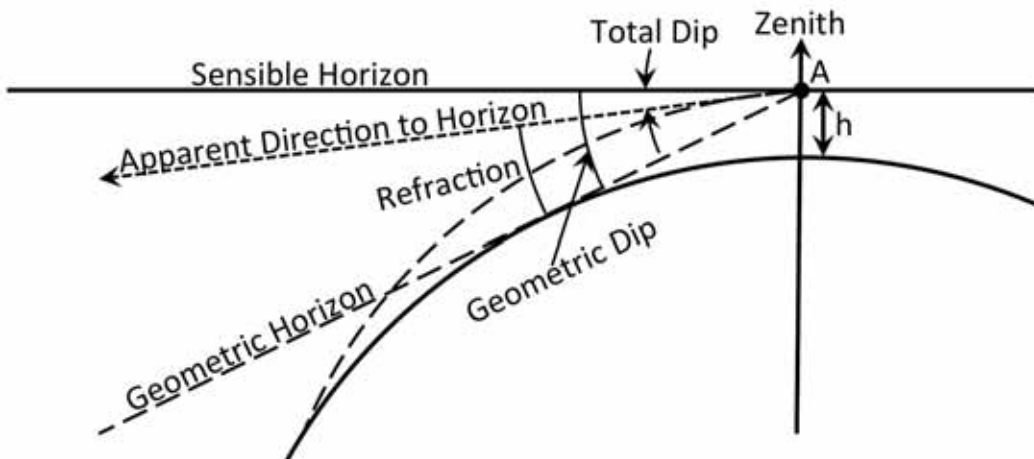

Figure 1328. The sensible horizon.

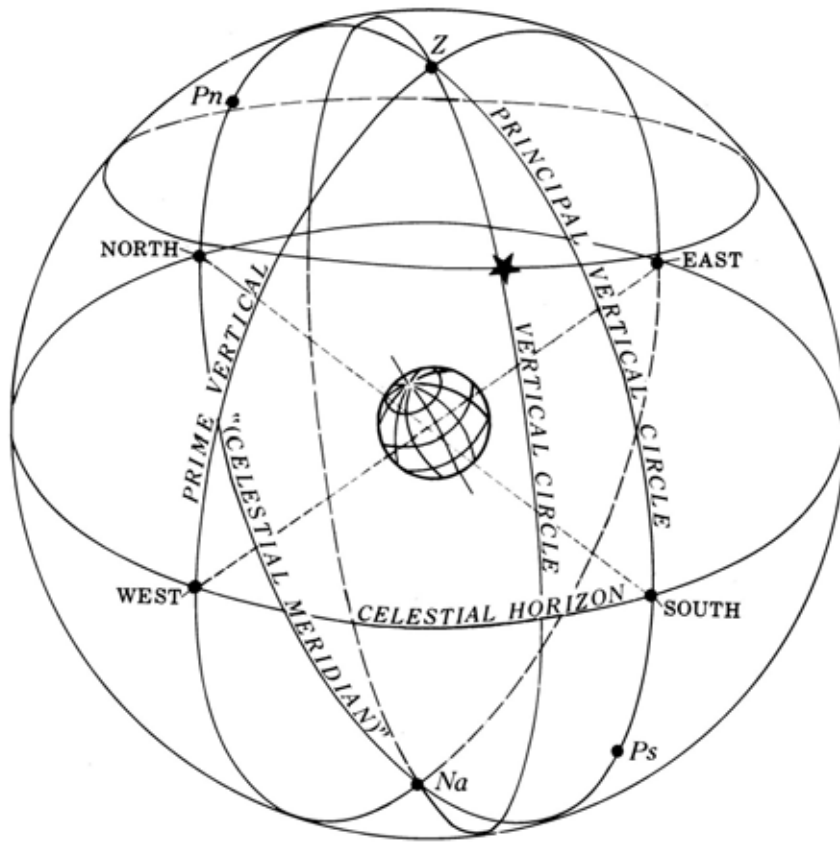

Figure 1329a. Elements of the celestial sphere. The celestial horizon is the primary great circle.

Earth	Celestial Equator	Horizon	Ecliptic
equator	celestial equator	horizon	ecliptic
poles	celestial poles	zenith; nadir	ecliptic poles
meridians	hours circle; celestial meridians	vertical circles	circles of latitude
prime meridian	hour circle of Aries	principal or prime vertical circle	circle of latitude through Aries
parallels	parallels of declination	parallels of altitude	parallels of latitude
latitude	declination	altitude	ecliptic altitude
colatitude	polar distance	zenith distance	ecliptic colatitude
longitude	SHA; RA; GHA; LHA; t	azimuth; azimuth angle; amplitude	ecliptic longitude

Table 1329. The four systems of celestial coordinates and their analogous terms.

is the apparent path of the Sun around the celestial sphere. The points 90° from the ecliptic are the north and south ecliptic poles. The series of great circles through these poles, analogous to meridians, are **circles of latitude**. The circles parallel to the plane of the ecliptic, analogous to par-

allels on the Earth, are parallels of latitude or **circles of longitude**. Angular distance north or south of the ecliptic, analogous to latitude, is ecliptic latitude. Ecliptic longitude is measured eastward along the ecliptic through 360°, starting at the vernal equinox. The mean plane of the Sun's orbit

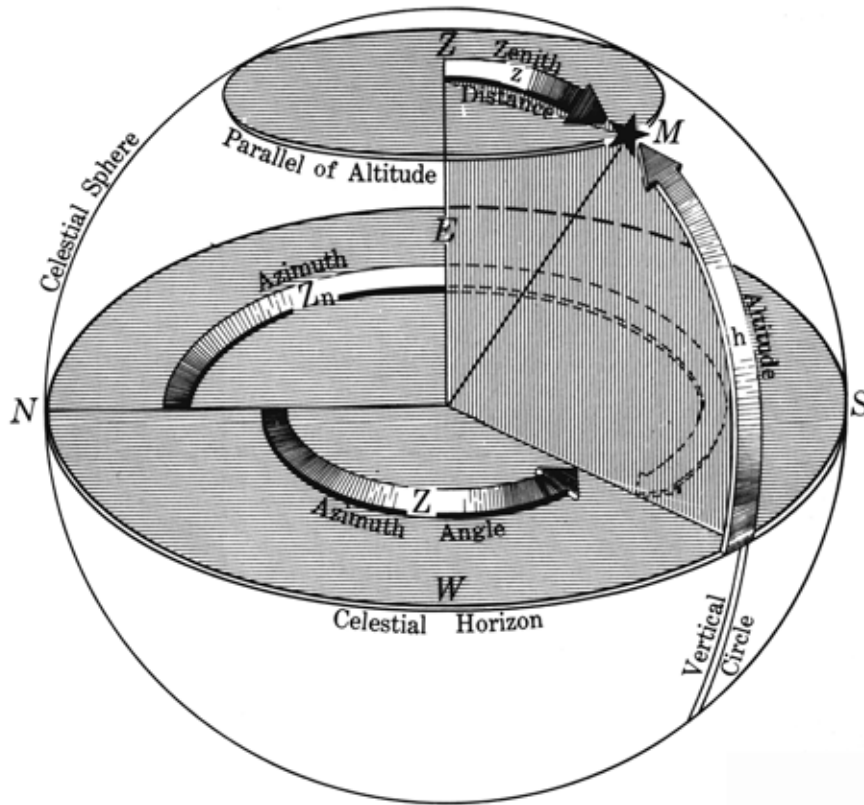

Figure 1329b. Elements of the celestial sphere. The celestial horizon.

lies in the ecliptic and the planes of the orbits of the Moon and planets are near the ecliptic. Because the planes of their orbits lie near the ecliptic, it is easier to predict the positions of the Sun, Moon, and planets using ecliptic coordinates.

The four systems of celestial coordinates are analogous

to each other and to the terrestrial system, although each has distinctions such as differences in primary reference planes. Table 1329 indicates the analogous term or terms under each system. Also see Table 1330.

NAVIGATIONAL COORDINATES

Coordinate	Symbol	Measured from	Measured along	Direction	Measured to	Units	Precision	Maximum value	Labels
latitude	L, lat.	equator	meridian	N, S	parallel	°, ¢	0¢.1	90°	N, S
colatitude	colat.	poles	meridian	S, N	parallel	°, ¢	0¢.1	90°	—
longitude	l, long.	prime meridian	parallel	E, W	local meridian	°, ¢	0¢.1	180°	E, W
declination	d, dec.	celestial equator	hour circle	N, S	parallel of declination	°, ¢	0¢.1	90°	N, S
polar distance	p	elevated pole	hour circle	S, N	parallel of declination	°, ¢	0¢.1	180°	—
altitude	h	horizon	vertical circle	up	parallel of altitude	°, ¢	0¢.1	90°*	—
zenith distance	z	zenith	vertical circle	down	parallel of altitude	°, ¢	0¢.1	180°	—

Table 1330. Navigational Coordinates.

NAVIGATIONAL COORDINATES									
Coordinate	Symbol	Measured from	Measured along	Direction	Measured to	Units	Precision	Maximum value	Labels
azimuth	Zn	north	horizon	E	vertical circle	°	0°.1	360°	—
azimuth angle	Z	north, south	horizon	E, W	vertical circle	°	0°.1	180° or 90°	N, S...E, W
amplitude	A	east, west	horizon	N, S	body	°	0°.1	90°	E, W...N, S
Greenwich hour angle	GHA	Greenwich celestial meridian	parallel of declination	W	hour circle	°, ¢	0¢.1	360°	—
local hour angle	LHA	local celestial meridian	parallel of declination	W	hour circle	°, ¢	0¢.1	360°	—
meridian angle	t	local celestial meridian	parallel of declination	E, W	hour circle	°, ¢	0¢.1	180°	E, W
sidereal hour angle	SHA	hour circle of vernal equinox	parallel of declination	W	hour circle	°, ¢	0¢.1	360°	—
right ascension	RA	hour circle of vernal equinox	parallel of declination	E	hour circle	h, m, s	1s	24h	—
Greenwich mean time	GMT	lower branch Greenwich celestial meridian	parallel of declination	W	hour circle mean Sun	h, m, s	1s	24h	—
local mean time	LMT	lower branch local celestial meridian	parallel of declination	W	hour circle mean Sun	h, m, s	1s	24h	—
zone time	ZT	lower branch zone celestial meridian	parallel of declination	W	hour circle mean Sun	h, m, s	1s	24h	—
Greenwich apparent time	GAT	lower branch Greenwich celestial meridian	parallel of declination	W	hour circle apparent Sun	h, m, s	1s	24h	—
local apparent time	LAT	lower branch local celestial meridian	parallel of declination	W	hour circle apparent Sun	h, m, s	1s	24h	—
Greenwich sidereal time	GST	Greenwich celestial meridian	parallel of declination	W	hour circle vernal equinox	h, m, s	1s	24h	—
local sidereal time	LST	local celestial meridian	parallel of declination	W	hour circle vernal equinox	h, m, s	1s	24h	—

*When measured from celestial horizon.

Table 1330. Navigational Coordinates.

1331. The Navigational Triangle

A triangle formed by arcs of great circles of a sphere is called a **spherical triangle**. A spherical triangle on the celestial sphere is called a **celestial triangle**. The spherical triangle of particular significance to navigators is called the **navigational triangle**, formed by arcs of a celestial meridian, an hour circle, and a vertical circle. Its vertices are the elevated pole, the zenith, and a point on the celestial sphere (usually a celestial body). The terrestrial counterpart is also called a navigational triangle, being formed by arcs of two meridians and the great circle connecting two places on the Earth, one on each meridian. The vertices are the two places and a pole. In great-circle sailing these places are the point of departure and the destination. In celestial navigation they are the **assumed position (AP)** of the observer and the **geographical position (GP)** of the body (the point on the Earth's surface having the body in its zenith). The GP of the Sun is sometimes called the **subsolar point**, that of the

Moon the **sublunar point**, that of a satellite (either natural or artificial) the **subsattellite point**, and that of a star its **substellar** or **subastral point**. When used to solve a celestial observation, either the celestial or terrestrial triangle may be called the **astronomical triangle**.

The navigational triangle is shown in Figure 1331a on a diagram on the plane of the celestial meridian. The Earth is at the center, O. The star is at M, dd' is its parallel of declination, and hh' is its altitude circle.

In the figure, arc QZ of the celestial meridian is the latitude of the observer, and PnZ, one side of the triangle, is the colatitude. Arc AM of the vertical circle is the altitude of the body, and side ZM of the triangle is the zenith distance, or coaltitude. Arc LM of the hour circle is the declination of the body, and side PnM of the triangle is the polar distance, or codeclination.

The angle at the elevated pole, ZPnM, having the hour circle and the celestial meridian as sides, is the meridian angle, t. The angle at the zenith, PnZM, having the vertical

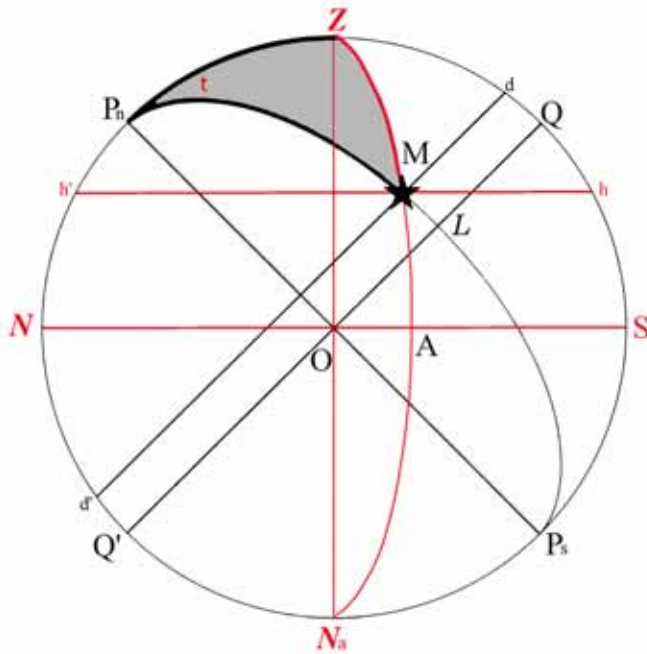

Figure 1331a. The navigational triangle.

circle and that arc of the celestial meridian, which includes the elevated pole, as sides, is the azimuth angle. The angle at the celestial body, ZMP_h , having the hour circle and the vertical circle as sides, is the parallactic angle (q) (sometimes called the position angle), which is not generally used by the navigator.

A number of problems involving the navigational triangle are encountered by the navigator, either directly or indirectly. Of these, the most common are:

1. Given latitude, declination, and meridian angle, to find of a celestial observation to establish a line of position.
2. Given latitude, altitude, and azimuth angle, to find declination and meridian angle. This is used to identify an unknown celestial body.
3. Given meridian angle, declination, and altitude, to find azimuth angle. This may be used to find azimuth when the altitude is known.
4. Given the latitude of two places on the Earth and the difference of longitude between them, to find the initial great-circle course and the great-circle distance. This involves the same parts of the triangle as in 1, above, but in the terrestrial triangle, and hence is defined differently.

Both celestial and terrestrial navigational triangles are shown in perspective in Figure 1331b.

IDENTIFICATION OF STARS AND PLANETS

1332. Introduction

A basic requirement of celestial navigation is the ability to identify the bodies observed. This is not difficult because relatively few stars and planets are commonly used for navigation, and various aids are available to assist in their identification. See Figure 1332, Figure 1333, Figure 1334a and Figure 1334b.

Identification of the Sun and Moon is straightforward, however, the planets can be mistaken for stars. A person working continually with the night sky recognizes a planet by its changing position among the relatively fixed stars. The planets are identified by noting their positions relative to each other, the Sun, the Moon, and the stars. They remain within the narrow limits of the ecliptic, but are in almost constant motion relative to the stars. The magnitude (brightness) and color may be helpful; they are some of the brightest objects in the sky. The information needed is found in the *Nautical Almanac*. The "Planet Notes" near the front of that volume are particularly useful. Planets can also be identified by planet diagram, star finder, sky diagram, or by computation.

1333. Stars

The *Nautical Almanac* lists full navigational informa-

tion on 19 first magnitude stars and 38 second magnitude stars, plus Polaris given its proximity to the north celestial pole. These are known as "selected stars" and are listed in the Index to Selected Stars in the *Nautical Almanac*. These stars can also be seen in Figure 1333 - Distribution of Selected Stars from the *Nautical Almanac*. These are some of the brightest stars, and span declinations from 70° south to 89° north on the celestial sphere. Abbreviated information is listed for 115 more, known as "tabulated stars." Additional stars are listed in the *Astronomical Almanac* and in various star catalogs. About 6,000 stars are visible to the unaided eye on clear, dark nights across the entire sky.

Stars are designated by one or more of the following naming systems:

- **Common Name:** Most names of stars, as now used, were given by the ancient Arabs and some by the Greeks or Romans. One of the stars of the *Nautical Almanac*, Nunki, was named by the Babylonians. Only a relatively few stars and often only the brightest have common names. Several of the stars on the daily pages of the almanacs had no name prior to 1953.
- **Bayer's Name:** Most bright stars, including those with names, have been given a designation consisting of a Greek letter followed by the

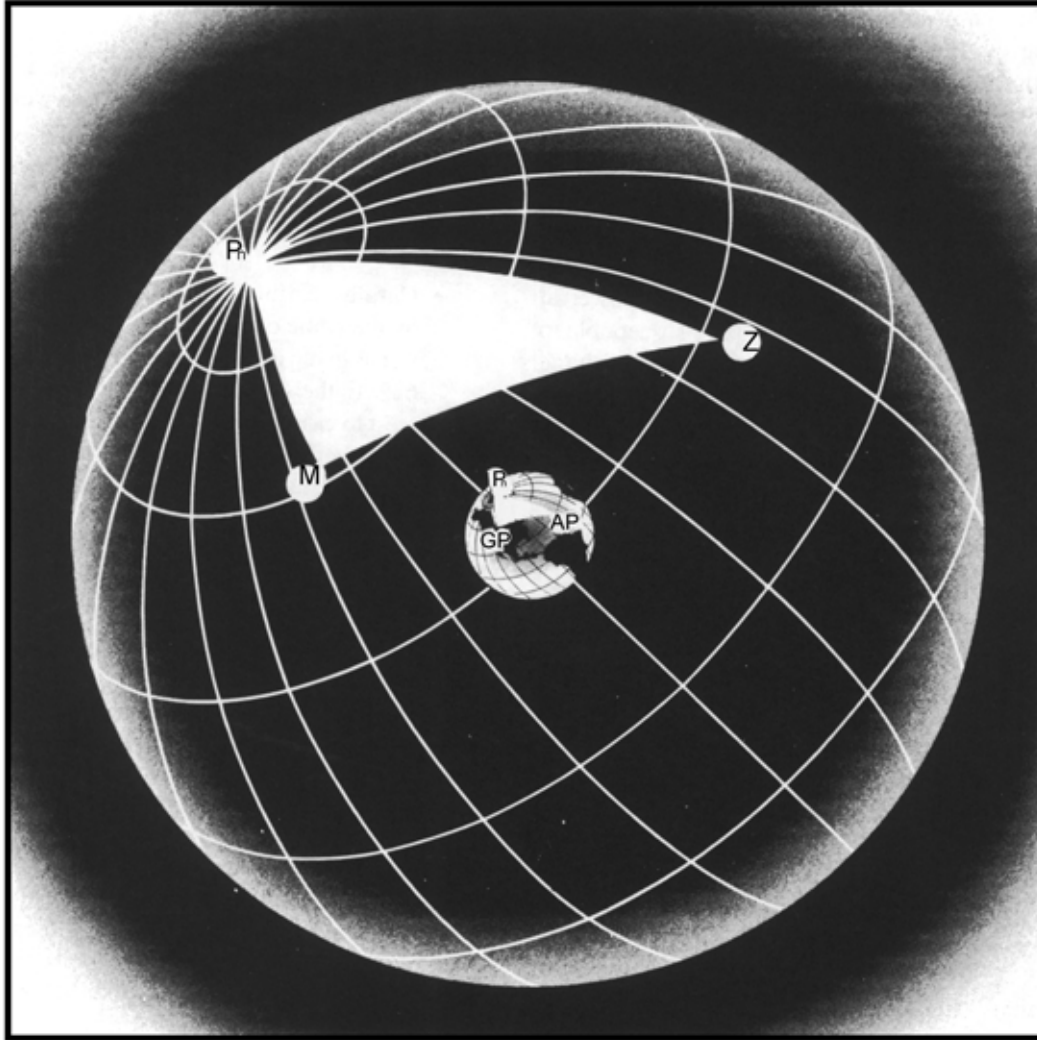

Figure 1331b. The navigational triangle in perspective.

possessive form of the name of the constellation. For example, the brightest star in the constellation Cygnus is known as (Greek letter “alpha”) Cygni, and also by its common name, Deneb. Roman letters are used when there are not enough Greek letters. Usually, the letters are assigned in order of brightness within the constellation; however, this is not always the case. For example, the letter designations of the stars in Ursa Major or the Big Dipper are assigned in order from the outer rim of the bowl to the end of the handle. This system of star designation was suggested by John Bayer of Augsburg, Germany, in 1603. All of the 173 stars included in the list near the back of the *Nautical Almanac* are listed by Bayer's name, and, when applicable, their common name.

- **Flamsteed's Number:** This system assigns numbers to stars in each constellation, from west to east in the order in which they cross the celestial meridian. An

example is 95 Leonis, the 95th star in the constellation Leo. This system was suggested by John Flamsteed (1646-1719).

- **Catalog Number:** Stars are sometimes designated by the name of a star catalog and the number of the star as given in the catalog, such as the Henry Draper or Hipparcos catalogs. Stars are frequently listed in catalogs by increasing right ascension coordinate, without regard to constellation, for example, Polaris is known as HD 8890 and HIP 11767 in these catalogs. Navigators seldom have occasion to use this system.

1334. Star Charts

It is useful to be able to identify stars by relative position. A **star chart** (Figure 1334a and Figure 1334b) is helpful in locating these relationships and others which may be useful. This method is limited to periods of relatively clear, dark skies with little or no

NAVIGATIONAL STARS AND THE PLANETS					
Name	Pronunciation	Bayer name	Origin of name	Meaning of name	Distance*
Acamar	á'ká-mâr	θ Eridani	Arabic	another form of Achernar	120
Achernar	á'kér-nâr	α Eridani	Arabic	end of the river (Eridanus)	72
Acrux	á'krûks	α Crucis	Modern	coined from Bayer name	220
Adhara	á-dá'rá	ε Canis Majoris	Arabic	the virgin(s)	350
Aldebaran	ál déb'á-rán	α Tauri	Arabic	follower (of the Pleiades)	64
Alioth	ál'í-óth	ε Ursa Majoris	Arabic	another form of Capella	49
Alkaid	ál-kád'	η Ursa Majoris	Arabic	leader of the daughters of the bier	190
Al Na'ir	ál-nâr'	α Gruis	Arabic	bright one (of the fish's tail)	90
Alnilam	ál'ni-lám	ε Orionis	Arabic	string of pearls	410
Alphard	ál'fárd	α Hydrae	Arabic	solitary star of the serpent	200
Alphecca	ál-fé'ká	α Corona Borealis	Arabic	feeble one (in the crown)	76
Alpheratz	ál-fé'râts	α Andromeda	Arabic	the horse's navel	120
Altair	ál-târ'	α Aquilae	Arabic	flying eagle or vulture	16
Ankaa	án'ká	α Phoenicis	Arabic	coined name	93
Antares	án-tâ'rêz	α Scorpii	Greek	rival of Mars (in color)	250
Arcturus	árk-tû'rûs	α Bootis	Greek	the bear's guard	37
Atria	át'ri-á	α Trianguli Australis	Modern	coined from Bayer name	130
Avior	á'vi-ór	ε Carinae	Modern	coined name	350
Bellatrix	bê-lâ'tríks	γ Orionis	Latin	female warrior	250
Betelgeuse	bê't'él-jûz	α Orionis	Arabic	the arm pit (of Orion)	300
Canopus	ká-nô'pûs	α Carinae	Greek	city of ancient Egypt	230
Capella	ká-pê'lá	α Aurigae	Latin	little she-goat	46
Deneb	dên'êb	α Cygni	Arabic	tail of the hen	600
Denebola	dê-nêb'ô-lá	β Leonis	Arabic	tail of the lion	42
Diphda	dîf'dá	β Ceti	Arabic	the second frog (Fomalhaut was once the first)	57
Dubhe	dûb'ê	α Ursa Majoris	Arabic	the bear's back	100
Elnath	êl'náth	β Tauri	Arabic	one butting with horns	130
Eltanin	êl-tâ'nin	γ Draconis	Arabic	head of the dragon	150
Enif	ên'if	ε Pegasi	Arabic	nose of the horse	250
Fomalhaut	fô'mál-ôt	α Piscis Austrini	Arabic	mouth of the southern fish	23
Gacrux	gá'krûks	γ Crucis	Modern	coined from Bayer name	72
Gienah	jê'ná	γ Corvi	Arabic	right wing of the raven	136
Hadar	há'dâr	β Centauri	Modern	leg of the centaur	200
Hamal	hâm'ál	α Arietis	Arabic	full-grown lamb	76
Kaus Australis	kôs ôs-trâ'lis	ε Sagittarii	Ar., L.	southern part of the bow	163
Kochab	kô'kâb	β Ursa Minoris	Arabic	shortened form of "north star" (named when it was that, c. 1500 BC-AD 300)	100
Markab	mâr'káb	α Pegasi	Arabic	saddle (of Pegasus)	100
Menkar	mên'kâr	α Ceti	Arabic	nose (of the whale)	1,100
Menkent	mên'kênt	θ Centauri	Modern	shoulder of the centaur	55
Miaplacidus	mî'á-plâs'í-dûs	β Carinae	Ar., L.	quiet or still waters	86
Mirfak	mîr'fák	α Persei	Arabic	elbow of the Pleiades	130
Nunki	nûn'kê	ε Sagittarii	Bab.	constellation of the holy city (Eridu)	150
Peacock	pê'kôk	α Pavonis	Modern	coined from English name of constellation	250
Polaris	pô-lâ'ris	α Ursa Minoris	Latin	the pole (star)	450
Pollux	pôl'ûks	β Geminorum	Latin	Zeus' other twin son (Castor, α Geminorum, is first twin)	33
Procyon	prô'si-ôn	α Canis Minoris	Greek	before the dog (rising before the dog star, Sirius)	11
Rasalhague	râs'âj-hâ'gwê	α Ophiuchi	Arabic	head of the serpent charmer	67
Regulus	rêg'û-lûs	α Leonis	Latin	the prince	67
Rigel	rî'jêl	β Orionis	Arabic	foot (left foot of Orion)	500
Rigel Kentaurus	rî'jêl kên-tô'rûs	α Centauri	Arabic	foot of the centaur	4.3
Sabik	sâ'bík	η Ophiuchi	Arabic	second winner or conqueror	69
Schedar	shêd'âr	α Cassiopeiae	Arabic	the breast (of Cassiopeia)	360
Shaula	shô'lá	λ Scorpii	Arabic	cocked-up part of the scorpion's tail	200
Sirius	sîr'í-ûs	α Canis Majoris	Greek	the scorching one (popularly, the dog star)	8.6
Spica	spl'ká	α Virginis	Latin	the ear of corn	155
Suhail	sôo-hâil'	λ Velorum	Arabic	shortened form of Al Suhail, one	200
Vega	vê'gá	α Lyrae	Arabic	Arabic name for Canopus	27
Zubenelgenubi	zôo-bên'êl-jê-nû'bê	α Librae	Arabic	the falling eagle or vulture	66
				southern claw (of the scorpion)	

PLANETS			
Name	Pronunciation	Origin of name	Meaning of name
Mercury	mûr'kû-rí	Latin	god of commerce and gain
Venus	vê'nûs	Latin	goddess of love
Earth	úrth	Mid. Eng.	—
Mars	mârz	Latin	god of war
Jupiter	jôo'pî-têr	Latin	god of the heavens, identified with the Greek Zeus, chief of the Olympian gods
Saturn	sât'êrn	Latin	god of seed-sowing
Uranus	û'râ-nûs	Greek	the personification of heaven
Neptune	nêp'tûn	Latin	god of the sea
Pluto	plôo'tô	Greek	god of the lower world (Hades)

Guide to pronunciations: fâte, ádd, fínál, lást, ábound, úrn; bê, ênd, camêl, readêr; íce, bit, ánfmal; ôver, pôetic, hôt, lôrd, mûôn; tâbe, únite, tâb, circûs, úrn
 *Distances in light-years. One light-year equals approximately 63,300 AU, or 5,880,000,000,000 miles. Authorities differ on distances of the stars; the values given are representative.

Figure 1332. Navigational stars and the planets.

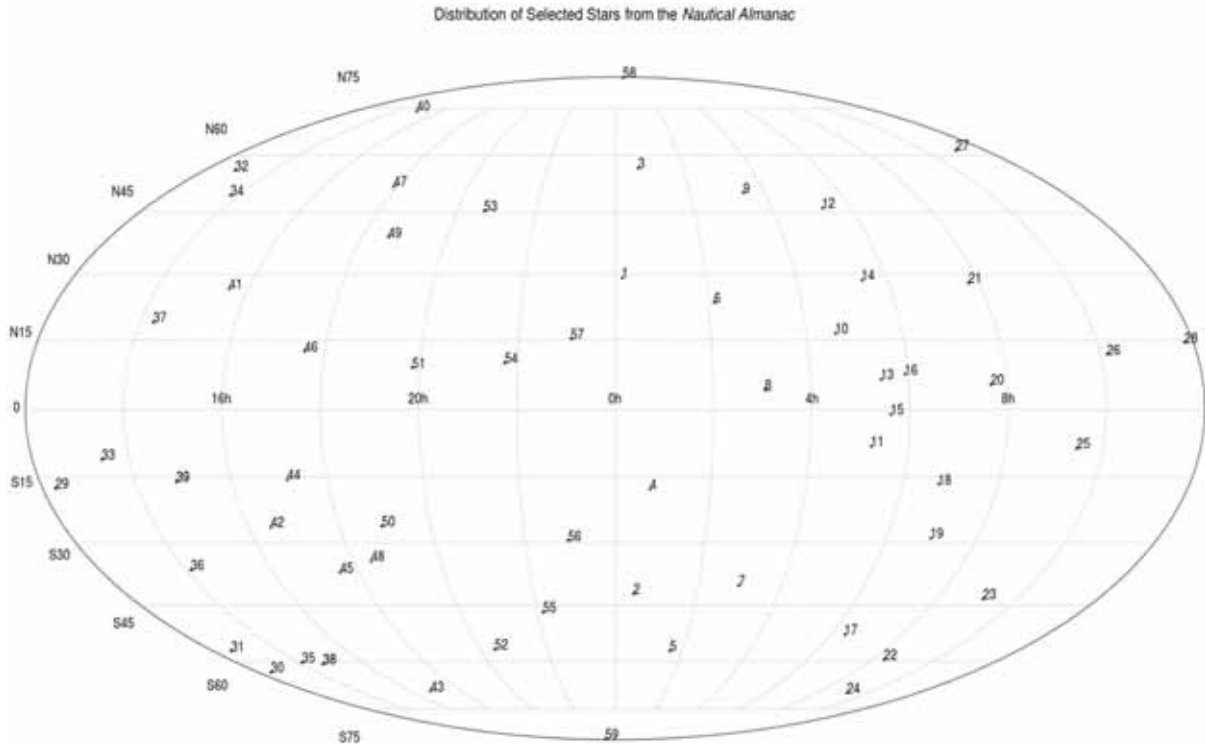

Figure 1333. Distribution of Selected Stars from the Nautical Almanac.

overcast. Stars can also be identified by the Air Almanac **sky diagrams**, a **star finder**, Pub. No. 249, or by computation by hand, navigational calculator, computer software or even smart phone applications.

Star charts are based upon the celestial equator system of coordinates, using declination and sidereal hour angle (or right ascension). See Figure 1334c for a graphical depiction of right ascension. The zenith of the observer is at the intersection of the parallel of declination equal to his or her latitude, and the hour circle coinciding with his or her celestial meridian. This hour circle has an SHA equal to $360^\circ - \text{LHA}$ Ψ (or $\text{RA} = \text{LHA} \Psi$). The horizon is everywhere 90° from the zenith.

A **star globe** is similar to a terrestrial sphere, but with stars (and often constellations) shown instead of geographical positions. The Nautical Almanac (page 260) includes instructions for using this device. On a star globe the celestial sphere is shown as it would appear to an observer outside the sphere. Constellations appear reversed. Star charts may show a similar view, but more often they are based upon the view from inside the sphere, as seen from the Earth. On these charts, north is at the top, as with maps, but east is to the left and west to the right. The directions seem correct when the chart is held overhead, with the top toward the north, so the relationship is similar to the sky.

The *Nautical Almanac* has four star charts, located on pages 266 and 267. Two are polar projections of each hemisphere, and two are Mercator projections from 30°N to 30°S . On any of these charts, the zenith can be located as indicated, to determine which stars are overhead. The horizon is 90° from the zenith. The charts

can also be used to determine the location of a star relative to surrounding stars.

The star charts shown in Figure 1335 through Figure 1338 on the transverse Mercator projection, are designed to assist in learning Polaris and the stars listed on the daily pages of the *Nautical Almanac*. Each chart extends about 20° beyond each celestial pole, and about 60° (four hours) each side of the central hour circle (at the celestial equator). Therefore, they do not coincide exactly with that half of the celestial sphere above the horizon at any one time or place. The zenith, and hence the horizon, varies with the position of the observer on the Earth. It also varies with the rotation of the Earth (apparent rotation of the celestial sphere). The charts show all stars of fifth magnitude and brighter as they appear in the sky, but with some distortion toward the right and left edges.

The overprinted lines add certain information of use in locating the stars. Only Polaris and the 57 stars listed on the daily pages of the *Nautical Almanac* are named on the charts. The almanac star charts can be used to locate the additional stars given near the back of the *Nautical Almanac* and the Air Almanac. Dashed lines connect stars of some of the more prominent constellations. Solid lines indicate the celestial equator and useful relationships among stars in different constellations. The celestial poles are marked by crosses, and labeled. By means of the celestial equator and the poles, an observer can locate the zenith approximately along the mid hour circle, when this coincides with the celestial meridian, as shown in Table 1334. At any time

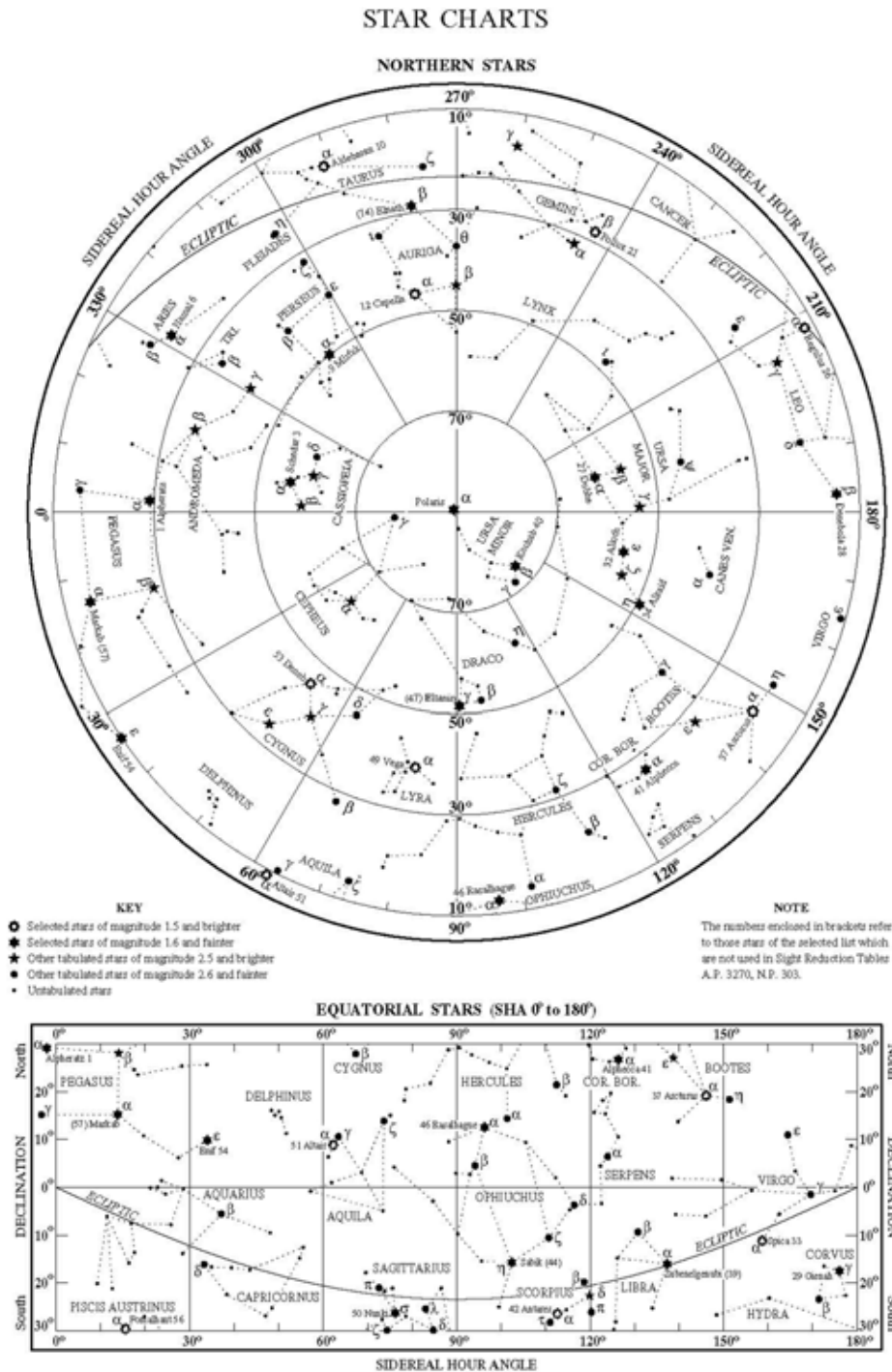

Figure 1334a. Star chart from *Nautical Almanac*.

earlier than those shown in Table 1334. The zenith is to the right of center, and at a later time it is to the left, approximately one-quarter of the distance from the center to the outer edge (at the celestial equator) for each hour that the time differs from that shown. The stars in the vicinity of the north celestial pole can be seen in proper perspective by inverting the chart, so that the zenith of an observer in the

Northern Hemisphere is up from the pole.

1335. Stars in the Vicinity of Pegasus

In autumn the evening sky has few first magnitude stars. Most are near the southern horizon of an observer in the latitudes of the United States. A relatively large number

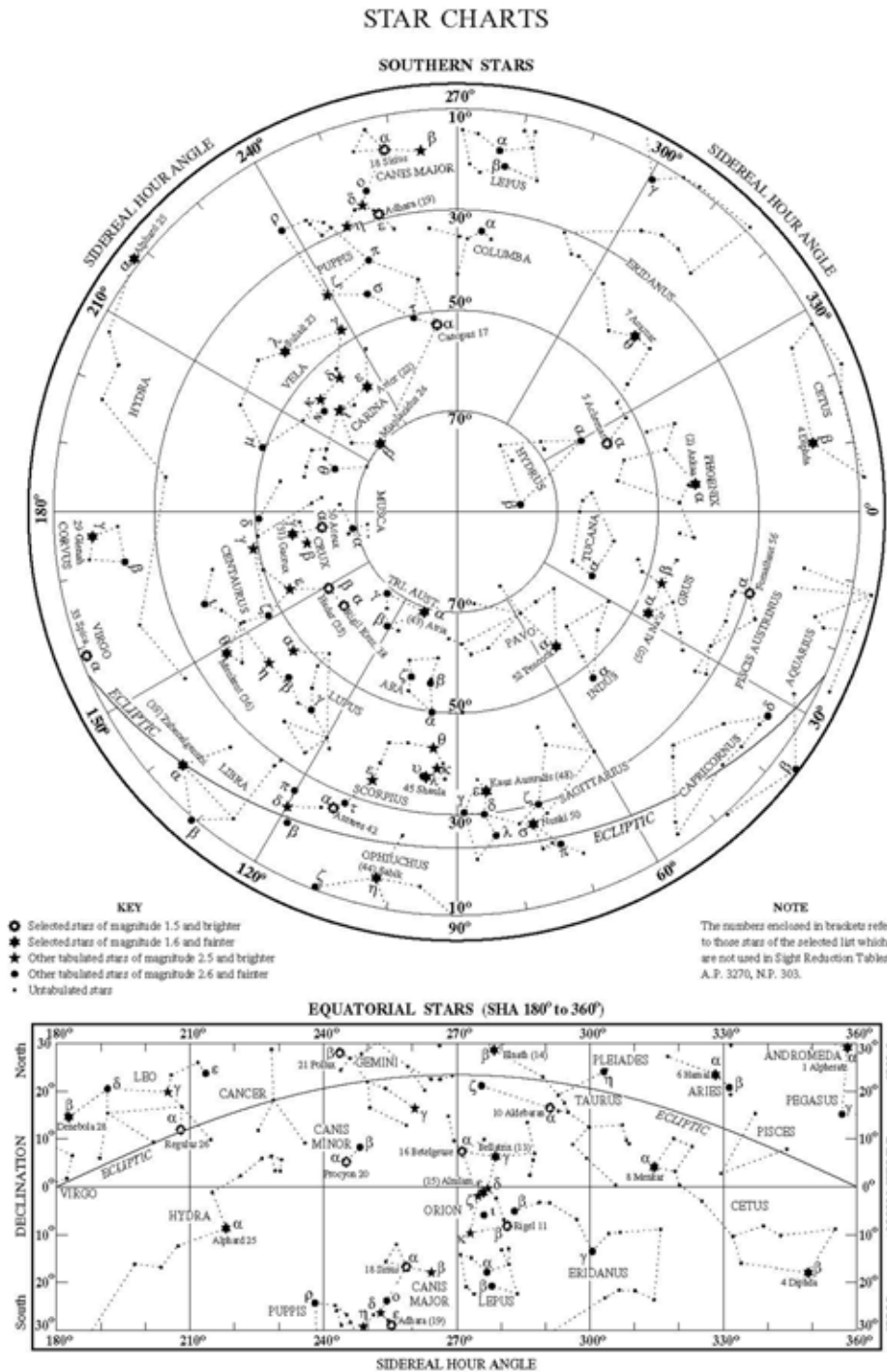

Figure 1334b. Star chart from *Nautical Almanac*.

of second and third magnitude stars seem conspicuous, perhaps because of the small number of brighter stars. High in the southern sky three third magnitude stars and one second magnitude star form a square with sides nearly 15° of arc in length. This is Pegasus, the winged horse.

Only Markab at the southwestern corner and Alpheratz at the northeastern corner are listed on the daily pages of the

Nautical Almanac. Alpheratz is part of the constellation Andromeda, the princess, extending in an arc toward the northeast and terminating at Mirfak in Perseus, legendary rescuer of Andromeda.

A line extending northward through the eastern side of the square of Pegasus passes through the leading (western) star of M-shaped (or W-shaped) Cassiopeia, the legendary

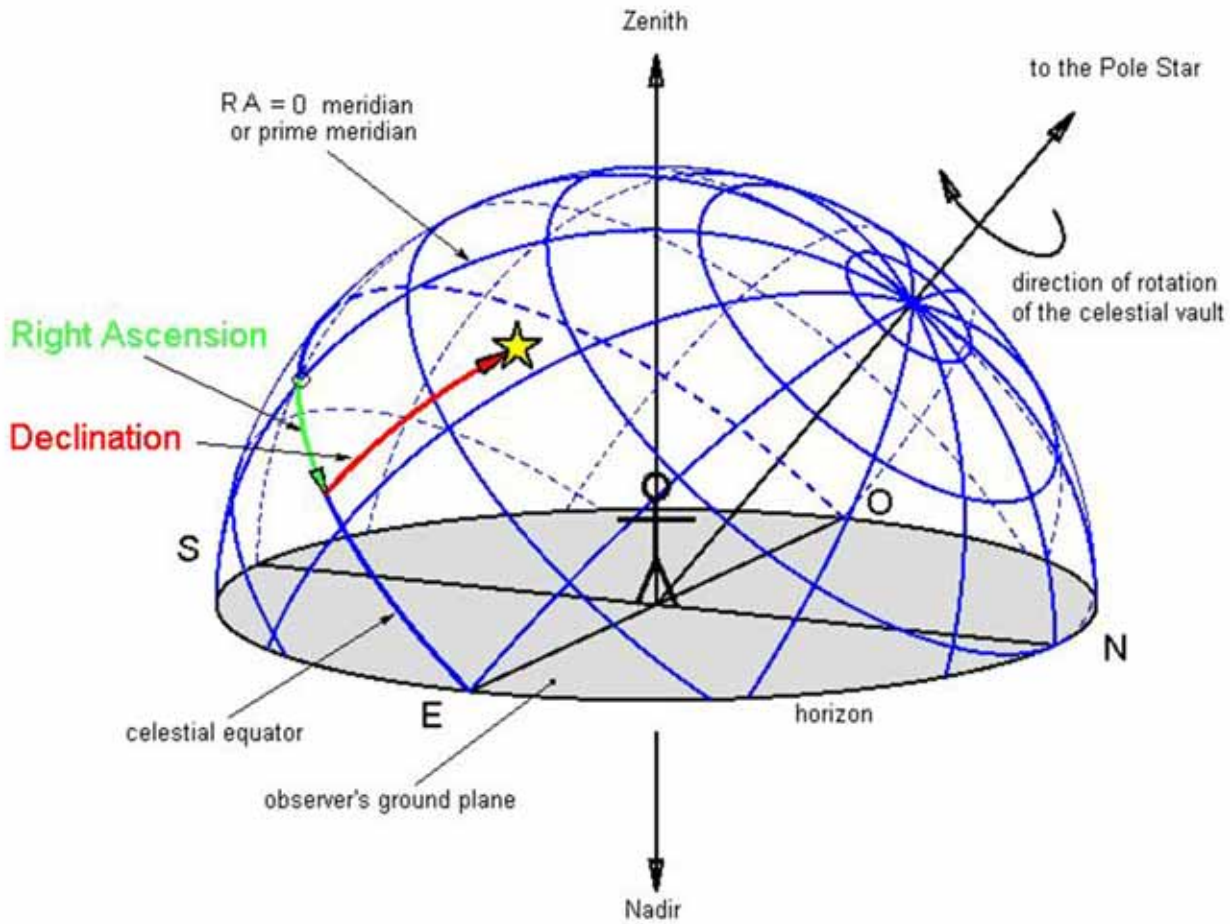

Figure 1334c. Star chart from Nautical Almanac.

	Fig. 1335	Fig.1336	Fig. 1337	Fig. 1338
Local sidereal time	0000	0600	1200	1800
LMT 1800	Dec. 21	Mar. 22	June 22	Sept. 21
LMT 2000	Nov. 21	Feb. 20	May 22	Aug. 21
LMT 2200	Oct. 21	Jan. 20	Apr. 22	July 22
LMT 0000	Sept. 22	Dec. 22	Mar. 23	June 22
LMT 0200	Aug. 22	Nov. 21	Feb. 21	May 23
LMT 0400	July 23	Oct. 22	Jan 21	Apr. 22
LMT 0600	June 22	Sept. 21	Dec. 22	Mar. 23

Table 1334d. Locating the zenith on the star diagrams.

mother of the princess Andromeda. The only star of this constellation listed on the RA daily pages of the *Nautical Almanac* is Schedar, the second star from the leading one as the configuration circles the pole in a counterclockwise direction. If the line through the eastern side of the square of Pegasus is continued on toward the north, it leads to second magnitude Polaris, the North Star (less than 1° from the north celestial pole) and brightest star of Ursa Minor, the

Little Dipper. Kochab, a second magnitude star at the other end of Ursa Minor, is also listed in the almanacs. At this season Ursa Major is low in the northern sky, below the celestial pole. A line extending from Kochab through Polaris leads to Mirfak, assisting in its identification when Pegasus and Andromeda are near or below the horizon.

Deneb, in Cygnus, the swan, and Vega are bright, first magnitude stars in the northwestern sky. The line through

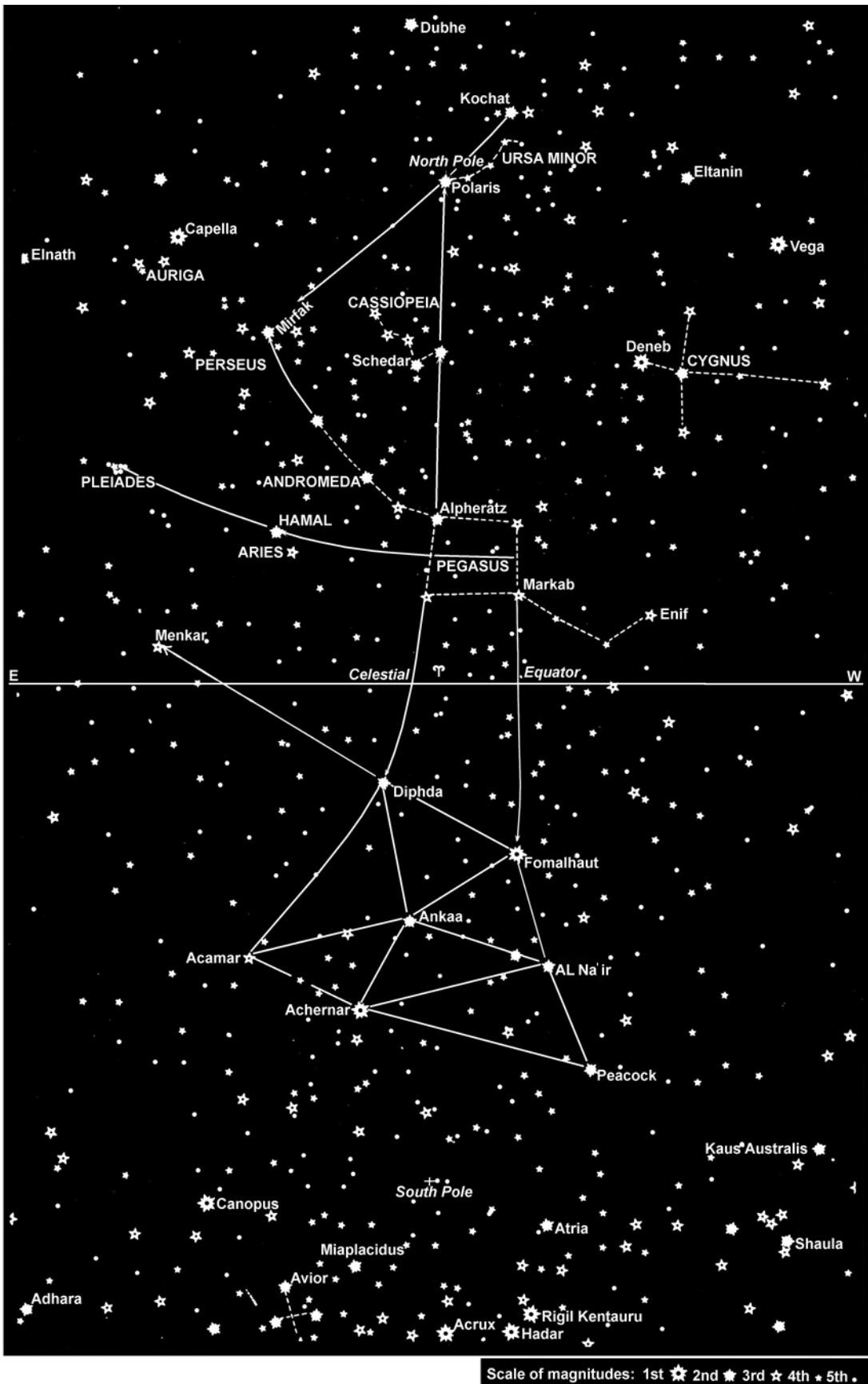

Figure 1335. Stars in the vicinity of Pegasus.

the eastern side of the square of Pegasus approximates the hour circle of the vernal equinox, shown at Aries on the celestial equator to the south. The Sun is at Aries on or about March 21, when it crosses the celestial equator from south to north. If the line through the eastern side of Pegasus is extended southward and curved slightly toward the east, it leads to second magnitude Diphda. A longer and straighter line southward through the western side of Pegasus leads to first magnitude Fomalhaut. A line extending northeasterly from Fomalhaut through Diphda leads to Menkar, a third magnitude star, but the brightest in its vicinity. Ankaa, Diphda, and Fomalhaut form an isosceles triangle, with the apex at Diphda. Ankaa is near or below the southern horizon of observers in latitudes of the United States. Four stars farther south than Ankaa may be visible when on the celestial meridian, just above the horizon of observers in latitudes of the extreme southern part of the United States. These are Acamar, Achernar, Al Na'ir, and Peacock. These stars, with each other and with Ankaa, Fomalhaut, and Diphda, form a series of triangles as shown in Figure 1335. Almanac stars near the bottom of Figure 1335 are discussed in succeeding articles.

Two other almanac stars can be located by their positions relative to Pegasus. These are Hamal in the constellation Aries, the ram, east of Pegasus, and Enif, west of the southern part of the square, identified in Figure 1335. The line leading to Hamal, if continued, leads to the Pleiades (the Seven Sisters), not used by navigators for celestial observations, but a prominent figure in the sky, heralding the approach of the many conspicuous stars of the winter evening sky.

1336. Stars in the Vicinity of Orion

As Pegasus leaves the meridian and moves into the western sky, Orion, the hunter, rises in the east. With the possible exception of Ursa Major, no other configuration of stars in the entire sky is as well known as Orion and its immediate surroundings. In no other region are there so many first magnitude stars.

The belt of Orion, nearly on the celestial equator, is visible in virtually any latitude, rising and setting almost on the prime vertical, and dividing its time equally above and below the horizon. Of the three second magnitude stars forming the belt, only Alnilam, the middle one, is listed on the daily pages of the *Nautical Almanac*.

Four conspicuous stars form a box around the belt. Rigel, a hot, blue star, is to the south. Betelgeuse, a cool, red star lies to the north. Bellatrix, bright for a second magnitude star but overshadowed by its first magnitude neighbors, is a few degrees west of Betelgeuse. Neither the second magnitude star forming the southeastern corner of the box, nor any star of the dagger, is listed on the daily pages of the *Nautical Almanac*.

A line extending eastward from the belt of Orion, and curving toward the south, leads to Sirius, the brightest star

in the entire heavens, having a magnitude of -1.6 . Only Mars and Jupiter at or near their greatest brilliance, the Sun, Moon, and Venus are brighter than Sirius. Sirius is part of the constellation Canis Major, the large hunting dog of Orion. Starting at Sirius a curved line extends northward through first magnitude Procyon, in Canis Minor, the small hunting dog; first magnitude Pollux and second magnitude Castor (not listed on the daily pages of the *Nautical Almanac*), the twins of Gemini; brilliant Capella in Auriga, the charioteer; and back down to first magnitude Aldebaran, the follower, which trails the Pleiades, the seven sisters. Aldebaran, brightest star in the head of Taurus, the bull, may also be found by a curved line extending northwestward from the belt of Orion. The V-shaped figure forming the outline of the head and horns of Taurus points toward third magnitude Menkar. At the summer solstice the Sun is between Pollux and Aldebaran.

If the curved line from Orion's belt southeastward to Sirius is continued, it leads to a conspicuous, small, nearly equilateral triangle of three bright second magnitude stars of nearly equal brilliancy. This is part of Canis Major. Only Adhara, the westernmost of the three stars, is listed on the daily pages of the *Nautical Almanac*. Continuing on with somewhat less curvature, the line leads to Canopus, second brightest star in the heavens and one of the two stars having a negative magnitude (-0.9). With Suhail and Miaplacidus, Canopus forms a large, equilateral triangle which partly encloses the group of stars often mistaken for Crux. The brightest star within this triangle is Avior, near its center. Canopus is also at one apex of a triangle formed with Adhara to the north and Suhail to the east, another triangle with Acamar to the west and Achernar to the southwest, and another with Achernar and Miaplacidus. Acamar, Achernar, and Ankaa form still another triangle toward the west. Because of chart distortion, these triangles do not appear in the sky in exactly the relationship shown on the star chart. Other daily-page almanac stars near the bottom of Figure 1336 are discussed in succeeding articles.

In the winter evening sky, Ursa Major is east of Polaris, Ursa Minor is nearly below it, and Cassiopeia is west of it. Mirfak is northwest of Capella, nearly midway between it and Cassiopeia. Hamal is in the western sky. Regulus and Alphard are low in the eastern sky, heralding the approach of the configurations associated with the evening skies of spring.

1337. Stars in the Vicinity of Ursa Major

As if to enhance the splendor of the sky in the vicinity of Orion, the region toward the east, like that toward the west, has few bright stars, except in the vicinity of the south celestial pole. However, as Orion sets in the west, leaving Capella and Pollux in the northwestern sky, a number of good navigational stars move into favorable positions for observation.

Ursa Major, the great bear, appears prominently above the north celestial pole, directly opposite Cassiopeia, which

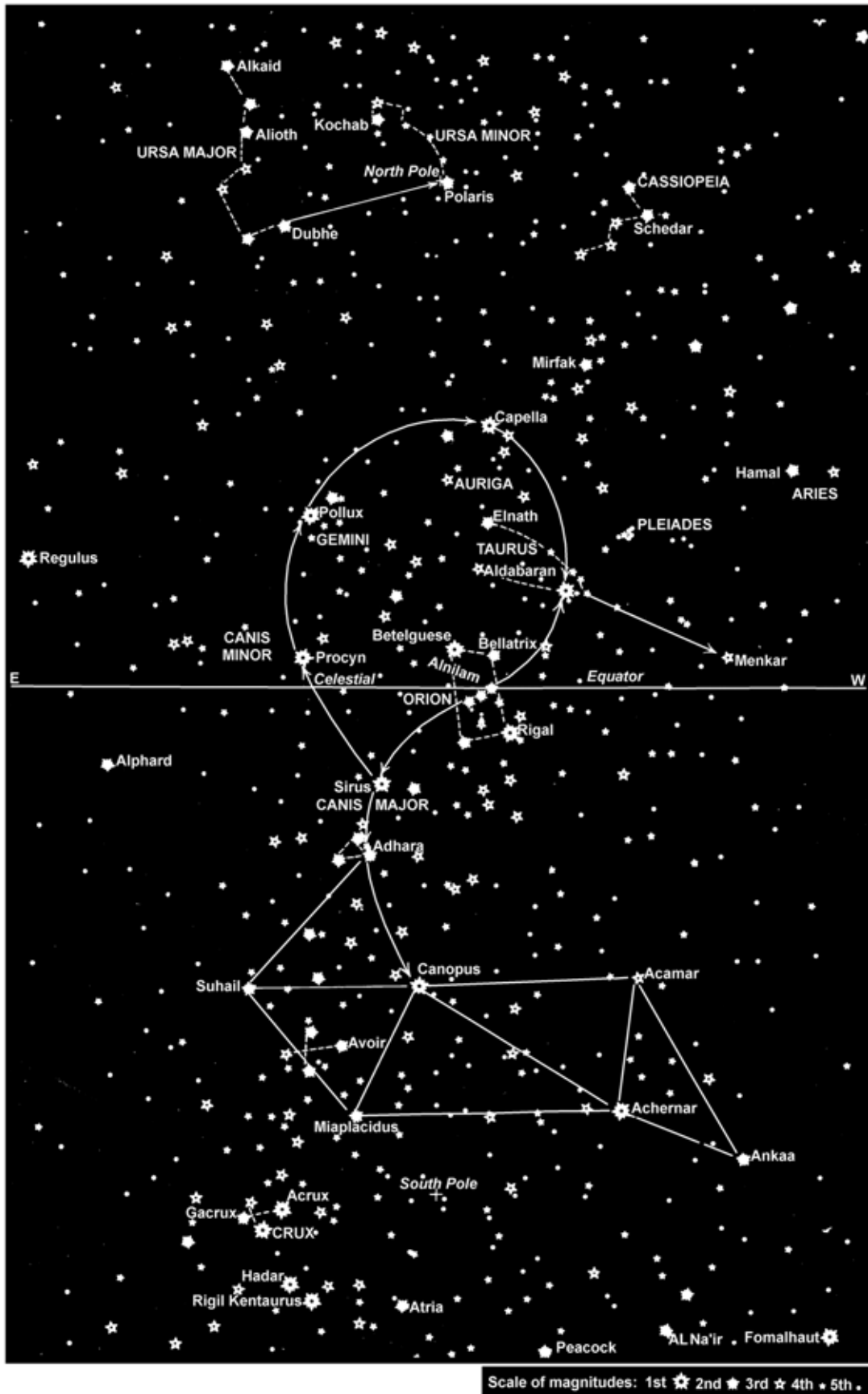

Figure 1336. Stars in the vicinity of Orion.

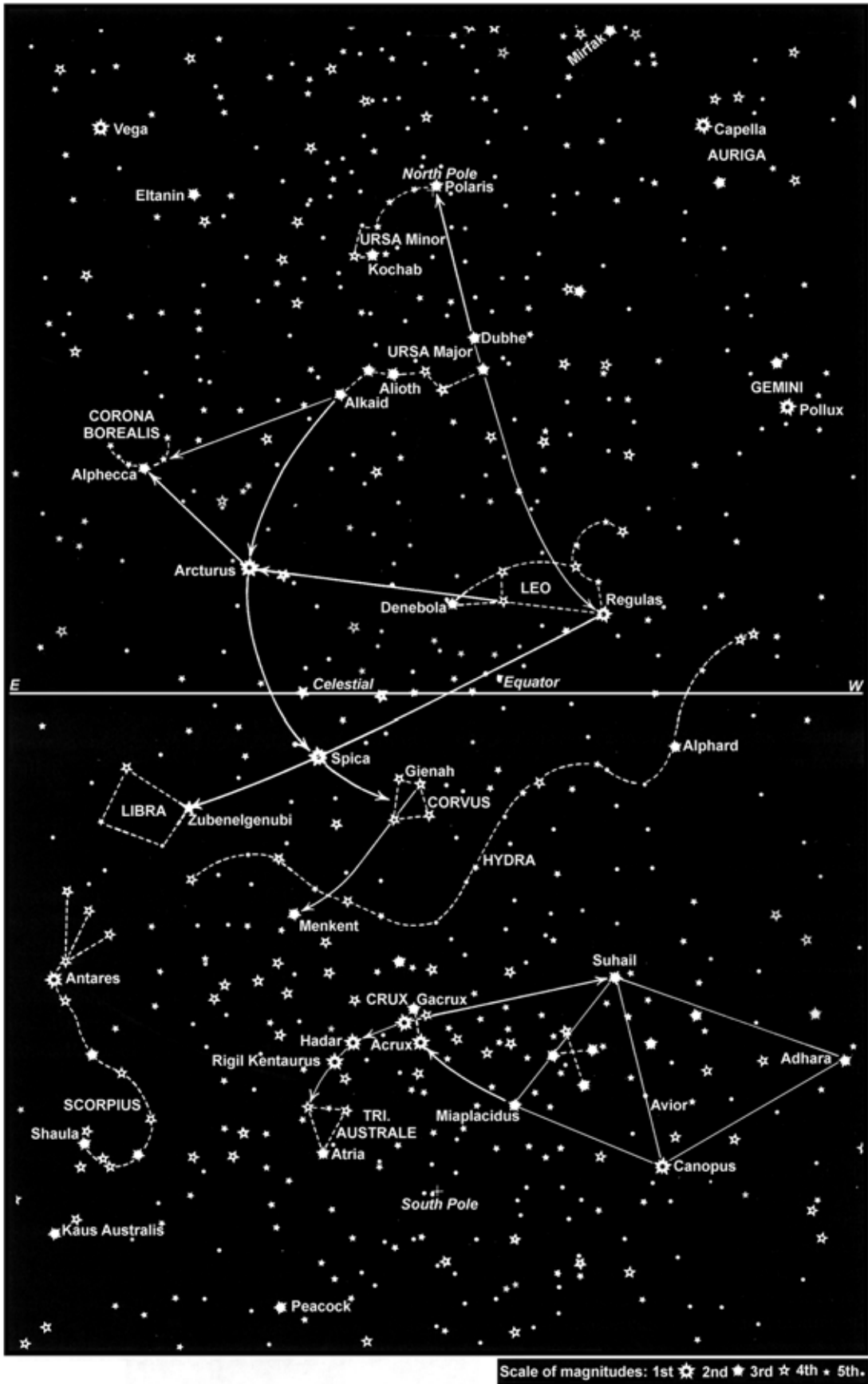

Figure 1337. Stars in the vicinity of Ursa Major.

appears as a “W” just above the northern horizon of most observers in latitudes of the United States. Of the seven stars forming Ursa Major, only Dubhe, Alioth, and Alkaid are in the list of selected stars in *Nautical Almanac*. See Figure 1337.

The two second magnitude stars forming the outer part of the bowl of Ursa Major are often called the pointers because a line extending northward (down in spring evenings) through them points to Polaris. Ursa Minor, the Little Bear, contains Polaris at one end and Kochab at the other. Relative to its bowl, the handle of Ursa Minor curves in the opposite direction to that of Ursa Major.

A line extending southward through the pointers, and curving somewhat toward the west, leads to first magnitude Regulus, brightest star in Leo, the lion. The head, shoulders, and front legs of this constellation form a sickle, with Regulus at the end of the handle. Toward the east is second magnitude Denebola, the tail of the lion. On toward the southwest from Regulus is second magnitude Alphard, brightest star in Hydra, the sea serpent. A dark sky and considerable imagination are needed to trace the long, winding body of this figure.

A curved line extending the arc of the handle of Ursa Major leads to first magnitude Arcturus. With Alkaid and Alphecca, brightest star in Corona Borealis, the Northern Crown, Arcturus forms a large, inconspicuous triangle. If the arc through Arcturus is continued, it leads next to first magnitude Spica and then to Corvus, the crow. The brightest star in this constellation is Gienah, but three others are nearly as bright. At autumnal equinox, the Sun is on the celestial equator, about midway between Regulus and Spica.

A long, slightly curved line from Regulus, east-southeasterly through Spica, leads to Zubenelgenubi at the southwestern corner of an inconspicuous box-like figure called Libra, the scales.

Returning to Corvus, a line from Gienah, extending diagonally across the figure and then curving somewhat toward the east, leads to Menkent, just beyond Hydra.

Far to the south, below the horizon of most northern hemisphere observers, a group of bright stars is a prominent feature of the spring sky of the Southern Hemisphere. This is Crux, the Southern Cross. Crux is about 40° south of Corvus. The “false cross” to the west is often mistaken for Crux. Acrux at the southern end of Crux and Gacrux at the northern end are selected stars, listed on the daily pages of the *Nautical Almanac*.

The triangles formed by Suhail, Miaplacidus, and Canopus, and by Suhail, Adhara, and Canopus, are west of Crux. Suhail is in line with the horizontal arm of Crux. A line from Canopus, through Miaplacidus, curved slightly toward the north, leads to Acrux. A line through the east-west arm of Crux, eastward and then curving toward the south, leads first to Hadar and then to Rigil Kentaurus, both very bright stars. Continuing on, the curved line leads to small Triangulum Australe, the Southern Triangle, the easternmost star of which is Atria.

1338. Stars in the Vicinity of Cygnus

As the celestial sphere continues in its apparent westward rotation, the stars familiar to a spring evening observer sink low in the western sky. By midsummer, Ursa Major has moved to a position to the left of the north celestial pole, and the line from the pointers to Polaris is nearly horizontal. Ursa Minor, is standing on its handle, with Kochab above and to the left of the celestial pole. Cassiopeia is at the right of Polaris, opposite the handle of Ursa Major. See Figure 1338.

The only first magnitude star in the western sky is Arcturus, which forms a large, inconspicuous triangle with Alkaid, the end of the handle of Ursa Major, and Alphecca, the brightest star in Corona Borealis, the Northern Crown.

The eastern sky is dominated by three very bright stars. The westernmost of these is Vega, the brightest star north of the celestial equator, and third brightest star in the heavens, with a magnitude of 0.1. With a declination of a little less than 39°N , Vega passes through the zenith along a path across the central part of the United States, from Washington in the east to San Francisco on the Pacific coast. Vega forms a large but conspicuous triangle with its two bright neighbors, Deneb to the northeast and Altair to the southeast. The angle at Vega is nearly a right angle. Deneb is at the end of the tail of Cygnus, the swan. This configuration is sometimes called the Northern Cross, with Deneb at the head. To modern youth it more nearly resembles a dive bomber, while it is still well toward the east, with Deneb at the nose of the fuselage. Altair has two fainter stars close by, on opposite sides. The line formed by Altair and its two fainter companions, if extended in a northwesterly direction, passes through Vega, and on to second magnitude Eltanin. The angular distance from Vega to Eltanin is about half that from Altair to Vega. Vega and Altair, with second magnitude Rasalhague to the west, form a large equilateral triangle. This is less conspicuous than the Vega-Deneb-Altair triangle because the brilliance of Rasalhague is much less than that of the three first magnitude stars, and the triangle is overshadowed by the brighter one.

Far to the south of Rasalhague, and a little toward the west, is a striking configuration called Scorpius, the scorpion. The brightest star, forming the head, is red Antares. At the tail is Shaula.

Antares is at the southwestern corner of an approximate parallelogram formed by Antares, Sabik, Nunki, and Kaus Australis. With the exception of Antares, these stars are only slightly brighter than a number of others nearby, and so this parallelogram is not a striking figure. At winter solstice the Sun is a short distance northwest of Nunki.

Northwest of Scorpius is the box-like Libra, the scales, of which Zubenelgenubi marks the southwest corner.

With Menkent and Rigil Kentaurus to the southwest,

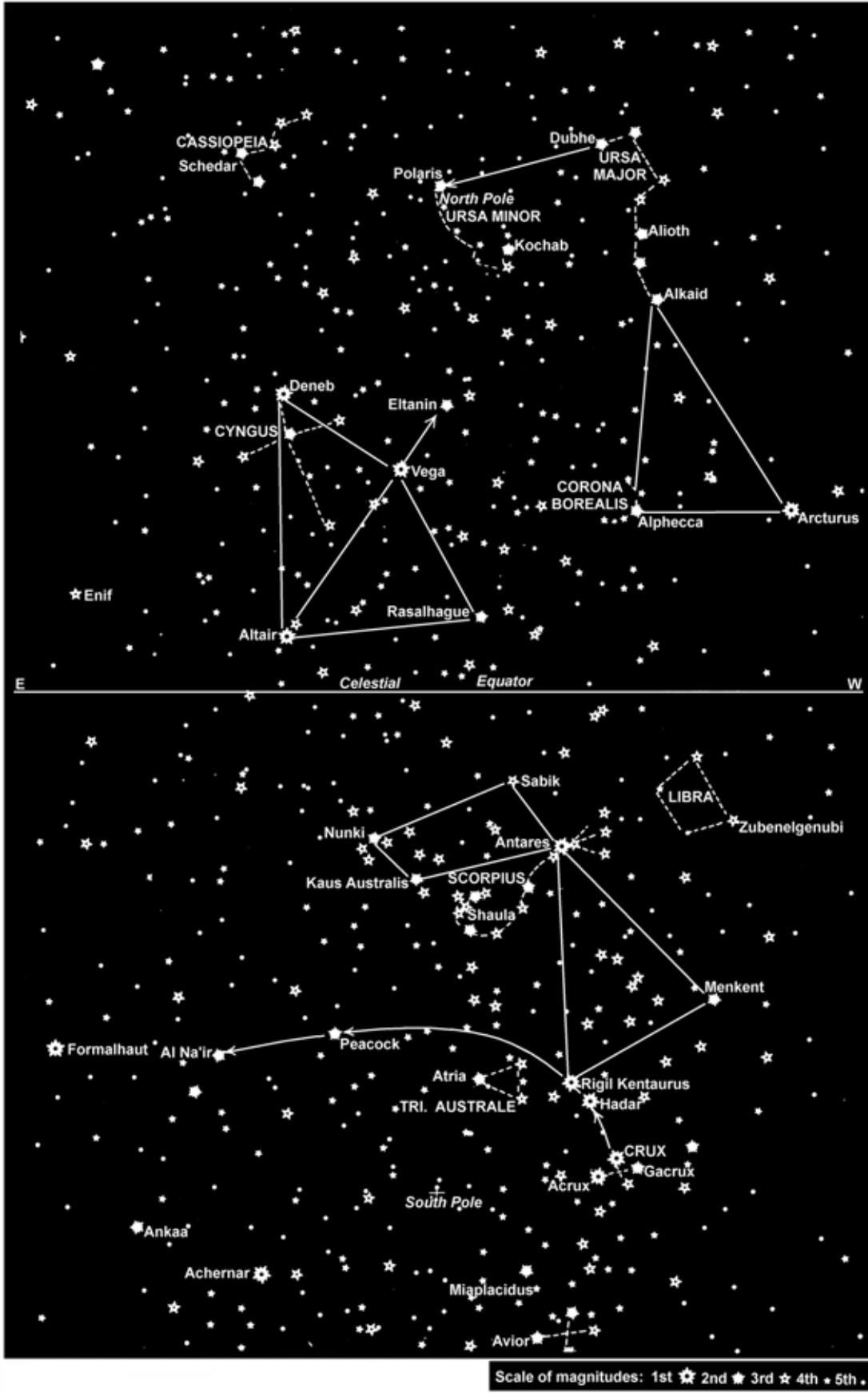

Figure 1338. Stars in the vicinity of Cygnus.

Antares forms a large but unimpressive triangle. For most observers in the latitudes of the United States, Antares is low in the southern sky, and the other two stars of the triangle are below the horizon. To an observer in the Southern Hemisphere Crux is to the right of the south celestial pole, which is not marked by a conspicuous star. A long, curved line, starting with the now-vertical arm of Crux and extending northward and then eastward, passes successively through Hadar, Rigil Kentaurus, Peacock, and Al Na'ir.

Fomalhaut is low in the southeastern sky of the southern hemisphere observer, and Enif is low in the eastern sky at nearly any latitude. With the appearance of these stars it is not long before Pegasus will appear over the eastern horizon during the evening, and as the winged horse climbs evening by evening to a position higher in the sky, a new annual cycle approaches.

1339. Planet Diagram

The planet diagram, on page 9 of the *Nautical Almanac* shows, for any date, the Local Mean Time (LMT) of meridian passage of the Sun, for the five planets Mercury, Venus, Mars, Jupiter, and Saturn, and of each 30° of SHA (Figure 1339). The diagram provides a general picture of the availability of planets and stars for observation, and thus shows:

1. Whether a planet or star is too close to the Sun for observation.
2. Whether a planet is a morning or evening star.
3. Some indication of the planet's position during twilight.
4. The proximity of other planets.
5. Whether a planet is visible from evening to morning twilight.

A band 45 minutes wide is shaded on each side of the curve marking the LMT of meridian passage of the Sun. Planets and stars lying within the shaded area are too close to the Sun for observation.

When the meridian passage occurs at midnight, the body is in opposition to the Sun and is visible all night; planets may be observable in both morning and evening twilights. When meridian passage is between 12h and 24h (that is, after the Sun's meridian passage), the object is visible in the evening sky, after sunset. When meridian passage is between 0 and 12 hours (that is, before the Sun's meridian passage) the object is visible in the morning sky, before sunrise. Graphically, if the curve for a planet intersects the vertical line connecting the date graduations below the shaded area, the planet is a morning "star"; if the intersection is above the shaded area, the planet is an evening "star".

Only about one-half the region of the sky along the ecliptic, as shown on the diagram, is above the horizon at one time. At sunrise (LMT about 6^h) the Sun and, hence, the

region near the middle of the diagram, are rising in the east; the region at the bottom of the diagram is setting in the west. The region half way between is on the meridian. At sunset (LMT about 18^h) the Sun is setting in the west; the region at the top of the diagram is rising in the east. Marking the planet diagram of the *Nautical Almanac* so that east is at the top of the diagram and west is at the bottom can be useful to interpretation.

A similar planet location diagram in the *Air Almanac* (pages A122-A123) represents the region of the sky along the ecliptic. It shows, for each date, the Sun in the center and the relative positions of the Moon, the five planets Mercury, Venus, Mars, Jupiter, Saturn and the four first magnitude stars Aldebaran, Antares, Spica, and Regulus, and also the position on the ecliptic which is north of Sirius (i.e. Sirius is 40° south of this point). The first point of Aries is also shown for reference. The magnitudes of the planets are given at suitable intervals along the curves. The Moon symbol shows the correct phase. A straight line joining the date on the left-hand side with the same date of the right-hand side represents a complete circle around the sky, the two ends of the line representing the point 180° from the Sun; the intersections with the curves show the spacing of the bodies along the ecliptic on the date. The time scale indicates roughly the local mean time at which an object will be on the observer's meridian.

At any time only about half the region on the diagram is above the horizon. At sunrise the Sun (and hence the region near the middle of the diagram), is rising in the east and the region at the end marked "West" is setting in the west; the region half-way between these extremes is on the meridian, as will be indicated by the local time (about 6^h). At the time of sunset (local time about 18^h) the Sun is setting in the west, and the region at the end marked "East" is rising in the east. The diagram should be used in conjunction with the Sky Diagrams.

1340. Finding Stars for a Fix

Various devices have been invented to help an observer find individual stars. The most widely used is the **Star Finder and Identifier**, also known as a **Rude Star Finder** and formerly published by the U.S. Navy Hydrographic Office as No. 2102D. It is no longer issued, but it is still available commercially. A navigational calculator or computer program, like the U.S. Navy STELLA program is much quicker, more accurate, and less tedious. A navigational calculator can be used to predict the best stars to observe for a fix. See Section 1900 - Computer Sight Reduction for a more thorough discussion.

HO Publication 249, (Rapid Sight Reduction Tables for Navigation), Volume 1, identifies the best three and seven stars for a navigational fix given an observer's latitude and LHA of Aries. This publication is also known as AP 3270.

The navigational program also solves for the LOP's for

PLANETS, 2016

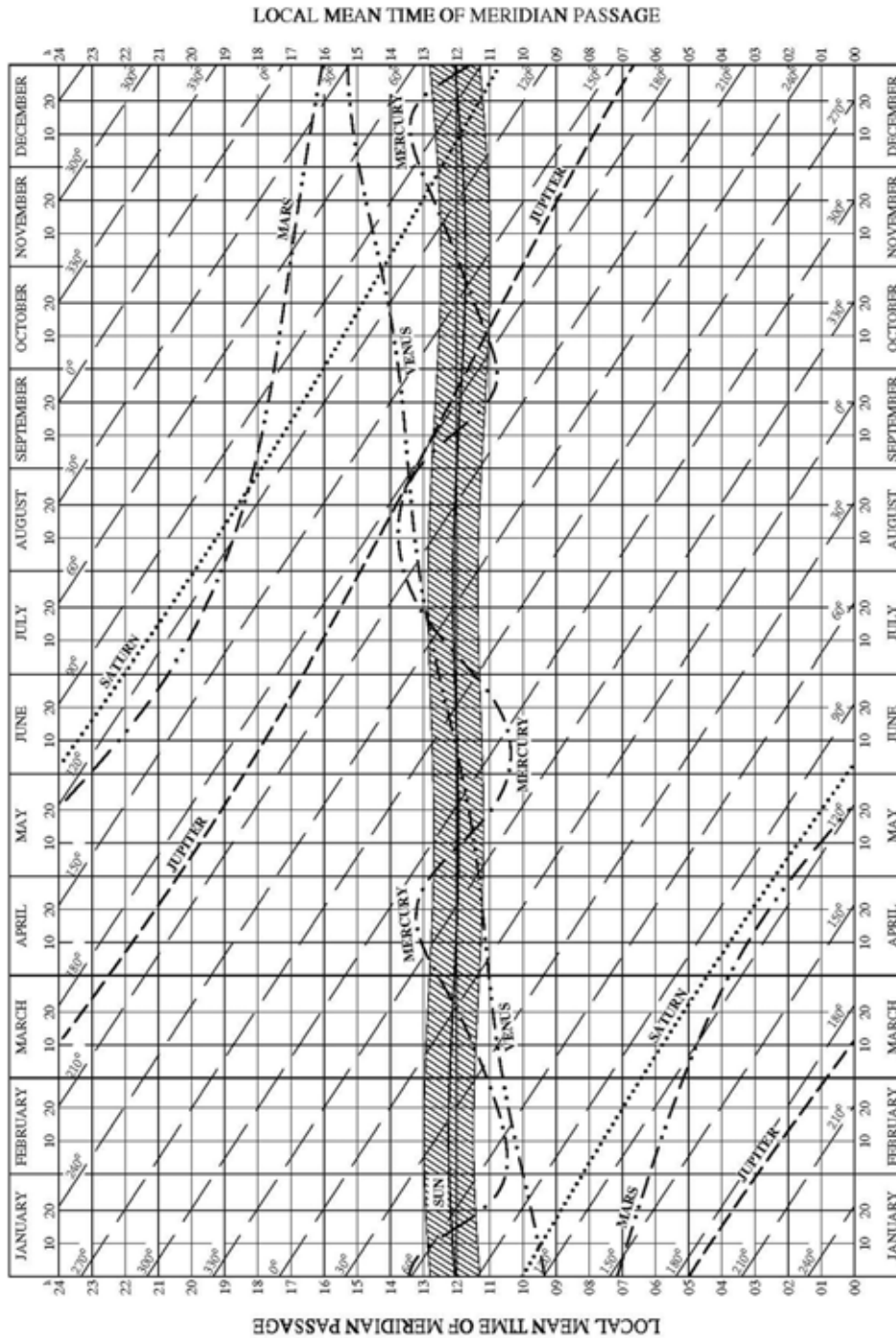

Figure 1339. Reproduction of Nautical Almanac Page 9.

each object observed, combines them into the best fix, and displays the lat./long. position. Most navigational programs also print out a plotted fix, just as the navigator might have drawn by hand.

Computer sight reduction programs can also automatically predict twilight on a moving vessel and create a plot

of the sky at the vessel's twilight location (or any location, at any time). This plot will be free of the distortion inherent in the mechanical star finders and will show all bodies, even planets, Sun, and Moon, in their correct relative orientation centered on the observer's zenith. It will also indicate which stars provide the best geometry for a fix.

Computer sight reduction programs or celestial navigation calculators, or apps are especially useful when the sky is only briefly visible through broken cloud cover.

1341. Identification by Computation

If the altitude and azimuth of the celestial body, and the approximate latitude of the observer, are known, the navigational triangle can be solved for meridian angle and declination. The meridian angle can be converted to LHA, and this to GHA. With this and GHA φ at the time of observation, the SHA of the body can be determined. With SHA and declination, one can identify the body by reference to an almanac. Any method of solving a spherical triangle, with two sides and the included angle being given, is suitable for this purpose.

Although no formal star identification tables are included in Pub. No. 229, a simple approach to star identification is to scan the pages of the appropriate latitudes, and observe the combination of arguments which give the altitude and azimuth angle of the observation. Thus the declination and LHA H are determined directly. The star's SHA is found from $SHA = LHA - LHA \varphi$. From

these quantities the star can be identified from the *Nautical Almanac*.

Another solution is available through an interchange of arguments using the nearest integral values. The procedure consists of entering Pub. No. 229 with the observer's latitude (same name as declination), with the observed azimuth angle (converted from observed true azimuth as required) as LHA and the observed altitude as declination, and extracting from the tables the altitude and azimuth angle respondents. The extracted altitude becomes the body's declination; the extracted azimuth angle (or its supplement) is the meridian angle of the body. Note that the tables are always entered with latitude of same name as declination. In north latitudes the tables can be entered with true azimuth as LHA.

If the respondents are extracted from above the C-S Line on a right-hand page, the name of the latitude is actually contrary to the declination. Otherwise, the declination of the body has the same name as the latitude. If the azimuth angle respondent is extracted from above the C-S Line, the supplement of the tabular value is the meridian angle, t , of the body. If the body is east of the observer's meridian, $LHA = 360^\circ - t$; if the body is west of the meridian, $LHA = t$.

CHAPTER 14

INSTRUMENTS FOR CELESTIAL NAVIGATION

THE MARINE SEXTANT

1400. Description and Use

The marine sextant measures the angle between two points by bringing the direct image from one point and a double-reflected image from the other into coincidence. Its principal use is to measure the altitudes of celestial bodies above the visible sea horizon. It may also be used to measure vertical angles to find the range from an object of known height. The marine sextant can also be used to render a visual Line of Position (LOP) by turning it on its side to horizontally measure the angular distance between two terrestrial objects. See Chapter 11- Use of Sextant in Piloting.

A marine sextant can measure angles up to approximately 120° . Originally, the term “sextant” was applied to the navigator’s double-reflecting, altitude-measuring instrument only if its arc was 60° in length, or $1/6$ of a circle, permitting measurement of angles from 0° to 120° . In modern usage the term is applied to all modern navigational altitude-measuring instruments regardless of angular range or principles of operation.

1401. Optical Principles of a Sextant

When a plane surface reflects a light ray, the angle of reflection equals the angle of incidence. The angle between the first and final directions of a ray of light that has undergone double reflection in the same plane is twice the angle the two reflecting surfaces make with each other.

In Figure 1401 - *Optical principle of the marine sextant*, S to M is a ray of light from a celestial body.

The index mirror of the sextant is at M, the horizon glass at F, and the eye of the observer at A. The ray of light from S is reflected at mirror M, proceeds to mirror F, where it is again reflected, and then continues on to the eye of the observer. Geometrically, it can be shown that the altitude of the object S (angle α) is two times that of the angle between the mirrors (angle β). The graduations on the arc give the altitude.

1402. Micrometer Drum Sextant

Figure 1402 shows a modern marine sextant, called a **micrometer drum sextant**. In most marine sextants, brass or aluminum comprise the **frame**, A. Frames come in vari-

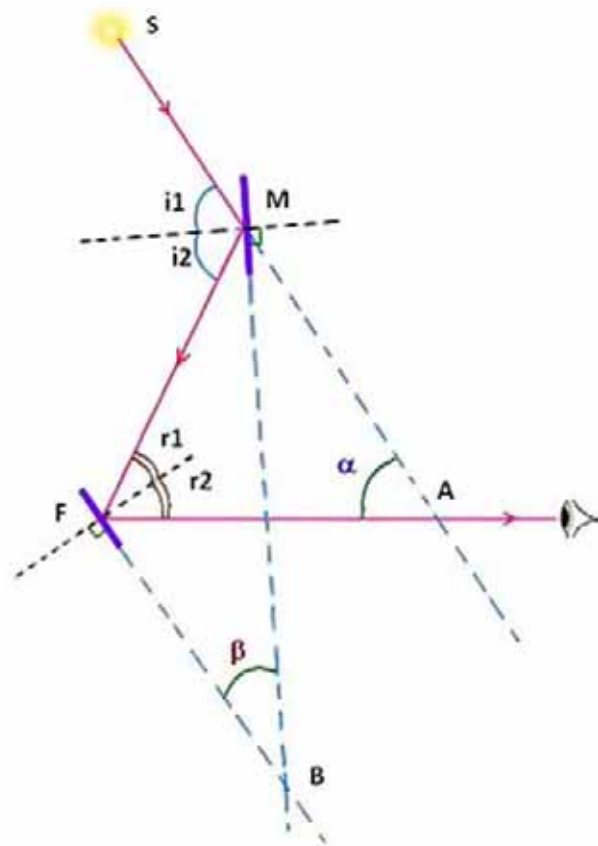

Figure 1401. Optical principle of the marine sextant.

ous designs; most are similar to this. Teeth mark the outer edge of the limb, B; each tooth marks one degree of altitude. The altitude graduations, C, along the limb, mark the arc. Some sextants have an arc marked in a strip of brass, silver, or platinum inlaid in the limb.

The **index arm**, D, is a movable bar of the same material as the frame. It pivots about the center of curvature of the limb. The **tangent screw**, E, is mounted perpendicularly on the end of the index arm, where it engages the teeth of the limb. Because the observer can move the index arm through the length of the arc by rotating the tangent screw, this is sometimes called an “endless tangent screw.” The **release**, F, is a spring-actuated clamp that keeps the tangent screw engaged with the limb’s teeth. The observer can disengage

the tangent screw and move the index arm along the limb for rough adjustment. The end of the tangent screw mounts a **micrometer drum**, G, graduated in minutes of altitude. One complete turn of the drum moves the index arm one degree along the arc. Next to the micrometer drum and fixed on the index arm is a **vernier**, H, that reads in fractions of a minute. The vernier shown is graduated into ten parts, permitting readings to $\frac{1}{10}$ of a minute of arc (0.1'). Some sextants have verniers graduated into only five parts, permitting readings to 0.2'.

The **index mirror**, I, is a piece of silvered plate glass mounted on the index arm, perpendicular to the plane of the instrument, with the center of the reflecting surface directly over the pivot of the index arm. The **horizon glass**, J, is a piece of optical glass silvered on its half nearer the frame. It is mounted on the frame, perpendicular to the plane of the sextant. The index mirror and horizon glass are mounted so that their surfaces are parallel when the micrometer drum is set at 0°, if the instrument is in perfect adjustment. **Shade glasses**, K, of varying darkness are mounted on the sextant's frame in front of the index mirror and horizon glass. They can be moved into the line of sight as needed to

reduce the intensity of light reaching the eye.

The **telescope**, L, screws into an adjustable collar in line with the horizon glass and parallel to the plane of the instrument. Most modern sextants are provided with only one telescope. When only one telescope is provided, it is of the "erect image type," either as shown or with a wider "object glass" (far end of telescope), which generally is shorter in length and gives a greater field of view. The second telescope, if provided, may be the "inverting type." The inverting telescope, having one lens less than the erect type, absorbs less light, but at the expense of producing an inverted image. A small colored glass cap is sometimes provided, to be placed over the "eyepiece" (near end of telescope) to reduce glare. With this in place, shade glasses are generally not needed. A "peep sight," or clear tube which serves to direct the line of sight of the observer when no telescope is used, may be fitted.

Sextants are designed to be held in the right hand. Some have a small light on the index arm to assist in reading altitudes. The batteries for this light are fitted inside a recess in the **handle**, M. Not clearly shown in Figure 1402 is the **tangent screw**, E, and the three legs.

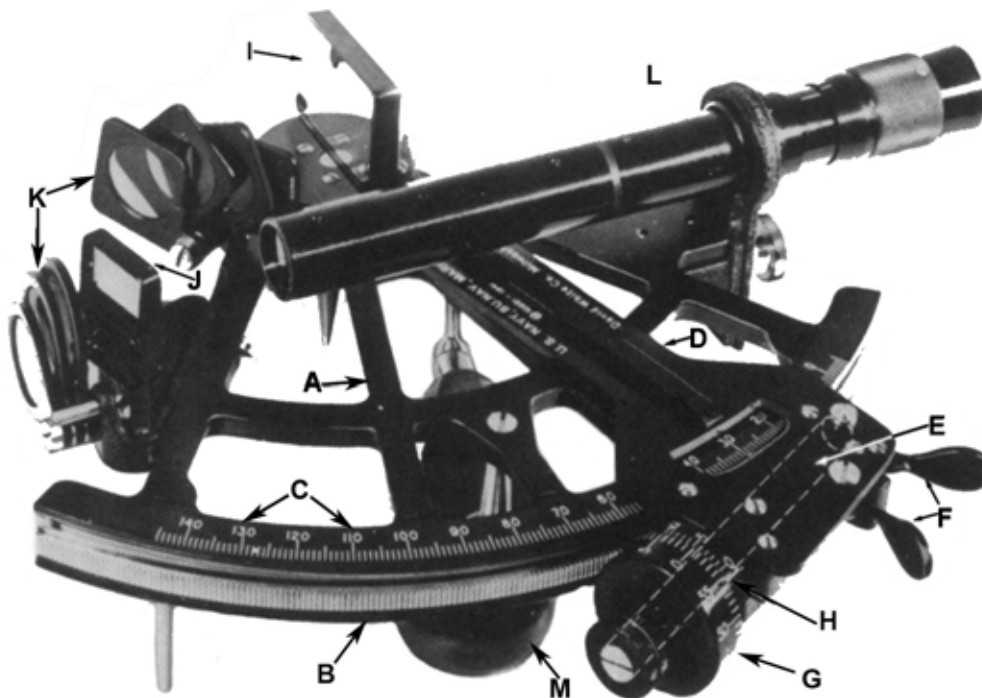

Figure 1402. U.S. Navy Mark 2 micrometer drum sextant.

There are two basic designs commonly used for mounting and adjusting mirrors on marine sextants. On the U.S. Navy Mark 3 and certain other sextants, the mirror is mounted so that it can be moved against retaining or mounting springs within its frame. Only one perpendicular adjustment screw is required. On the U.S. Navy Mark 2 and other sextants the mirror is fixed within its frame. Two perpendicular adjustment

screws are required. One screw must be loosened before the other screw bearing on the same surface is tightened.

1403. Vernier Sextant

Most recent marine sextants are of the micrometer drum type, but at least two older-type sextants are still in

use. These differ from the micrometer drum sextant principally in the manner in which the final reading is made. They are called **vernier sextants**.

The **clamp screw vernier sextant** is the older of the two. In place of the modern release clamp, a clamp screw is fitted on the underside of the index arm. To move the index arm, the clamp screw is loosened, releasing the arm. When the arm is placed at the approximate altitude of the body being observed, the clamp screw is tightened. Fixed to the clamp screw and engaged with the index arm is a long tangent screw. When this screw is turned, the index arm moves slowly, permitting accurate setting. Movement of the index arm by the tangent screw is limited to the length of the screw (several degrees of arc). Before an altitude is measured, this screw should be set to the approximate midpoint of its range. The final reading is made on a vernier set in the index arm below the arc. A small microscope or magnifying glass fitted to the index arm is used in making the final reading.

The **endless tangent screw vernier sextant** is identical to the micrometer drum sextant, except that it has no drum, and the fine reading is made by a vernier along the arc, as with the clamp screw vernier sextant. The release is the same as on the micrometer drum sextant, and teeth are cut into the underside of the limb which engage with the endless tangent screw.

1404. Sextant Sun Sights

For a Sun sight, hold the sextant vertically and direct the sight line at the horizon directly below the Sun. After moving suitable shade glasses into the line of sight, move the index arm outward along the arc until the reflected image appears in the horizon glass near the direct view of the horizon. Rock the sextant (also known as “swinging the arc” or “to swing the arc”) slightly to the right and left to ensure it is perpendicular. As you rock the sextant, the image of the Sun appears to move in an arc, and you may have to turn slightly to prevent the image from moving off the horizon glass.

The sextant is vertical when the Sun appears at the bottom of the arc. This is the correct position for making the observation. The Sun’s reflected image appears at the center of the horizon glass; one half appears on the silvered part, and the other half appears on the clear part. Move the index arm with the drum or vernier slowly until the Sun appears to be resting exactly on the horizon, tangent to the lower limb. The novice observer needs practice to determine the exact point of tangency. Beginners often err by bringing the image down too far.

Some navigators get their most accurate observations by letting the body contact the horizon by its own motion, bringing it slightly below the horizon if rising, and above if setting. At the instant the horizon is tangent to the disk, the navigator notes the time. The sextant altitude is the uncorrected reading of the sextant.

1405. Sextant Moon Sights

When observing the Moon, follow the same procedure as for the Sun. Because of the phases of the Moon, the upper limb of the Moon is observed more often than that of the Sun. When the terminator (the line between light and dark areas) is nearly vertical, be careful in selecting the limb to shoot. Sights of the Moon are best made during either daylight hours or that part of twilight in which the Moon is least luminous. At night, false horizons may appear below the Moon because the Moon illuminates the water below it.

1406. Sextant Star and Planet Sights

While the relatively large Sun and Moon are easy to find with a sextant, stars and planets can be more difficult to locate because the field of view is so narrow. One of three methods may help locate a star or planet:

Method 1. Set the index arm and micrometer drum on 0° and direct the line of sight at the body to be observed. Then, while keeping the reflected image of the body in the mirrored half of the horizon glass, swing the index arm out and rotate the frame of the sextant down. Keep the reflected image of the body in the mirror until the horizon appears in the clear part of the horizon glass; then, make the observation. When there is little contrast between brightness of the sky and the body this procedure can be difficult. If the body is “lost” while it is being brought down, it may not be recovered without starting over again.

Method 2. Direct the line of sight at the body while holding the sextant upside down. Slowly move the index arm out until the horizon appears in the horizon glass. Then invert the sextant and take the sight in the usual manner.

Method 3. Determine in advance the approximate altitude and azimuth of the body by a star finder such as No. 2102D. Set the sextant at the indicated altitude and face in the direction of the azimuth. The image of the body should appear in the horizon glass with a little searching.

When measuring the altitude of a star or planet, bring its center down to the horizon. Stars and planets have no discernible upper or lower limb; you must observe the center of the point of light. Because stars and planets have no discernible limb and because their visibility may be limited, the method of letting a star or planet intersect the horizon by its own motion is not recommended. As with the Sun and Moon, however, “swing the arc” to establish perpendicularity.

1407. Taking a Sight

Unless you have a navigation calculator, computer program, or app that will identify bodies automatically, predict expected altitudes and azimuths for up to eight bodies when preparing to take celestial sights. Choose the

stars and planets that will provide the best bearing spread. Try to select bodies with a predicted altitude between 30° and 70°. Take sights of the brightest stars first in the evening; take sights of the brightest stars last in the morning. See Chapter 18, Section 1810 - Sight Planning, for a more in depth discussion.

Occasionally, fog, haze, or other ships in a formation may obscure the horizon directly below a body which the navigator wishes to observe. If the arc of the sextant is sufficiently long, a **back sight** might be obtained, using the opposite point of the horizon as the reference. For this the observer faces away from the body and observes the supplement of the altitude. If the Sun or Moon is observed in this manner, what appears in the horizon glass to be the lower limb is in fact the upper limb, and vice versa. In the case of the Sun, it is usually preferable to observe what appears to be the upper limb. The arc that appears when rocking the sextant for a back sight is inverted; that is, the highest point indicates the position of perpendicularity.

If more than one telescope is furnished with the sextant, the erecting telescope is used to observe the Sun. A wider field of view is present if the telescope is not used. The collar into which the sextant telescope fits may be adjusted in or out, in relation to the frame. When moved in, more of the mirrored half of the horizon glass is visible to the navigator, and a star or planet is more easily observed when the sky is relatively bright. Near the darker limit of twilight, the telescope can be moved out, giving a broader view of the clear half of the glass, and making the less distinct horizon more easily discernible. If both eyes are kept open until the last moments of an observation, eye strain will be lessened. Practice will permit observations to be made quickly, reducing inaccuracy due to eye fatigue.

When measuring an altitude, have an assistant note and record the time if possible, with a "stand-by" warning when the measurement is almost ready, and a "mark" at the moment a sight is made. If a flashlight is needed to see the comparing watch, the assistant should be careful not to interfere with the navigator's night vision.

If an assistant is not available to time the observations, the observer holds the watch in the palm of his or her left hand, leaving his or her fingers free to manipulate the tangent screw of the sextant. After making the observation, s/he notes the time as quickly as possible. The delay between completing the altitude observation and noting the time should not be more than one or two seconds.

1408. Reading the Sextant

Reading a micrometer drum sextant is done in three steps. The degrees are read by noting the position of the arrow on the index arm in relation to the arc. The minutes are read by noting the position of the zero on the vernier with relation to the graduations on the micrometer drum. The fraction of a minute is read by noting which mark on the vernier most nearly coincides with one of the graduations

on the micrometer drum. This is similar to reading the time with the hour, minute, and second hands of a watch. In both, the relationship of one part of the reading to the others should be kept in mind. Thus, if the hour hand of a watch were about on "4," one would know that the time was about four o'clock. But if the minute hand were on "58," one would know that the time was 0358 (or 1558), not 0458 (or 1658). Similarly, if the arc indicated a reading of about 40°, and 58' on the micrometer drum were opposite zero on the vernier, one would know that the reading was 39° 58', not 40° 58'. Similarly, any doubt as to the correct minute can be removed by noting the fraction of a minute from the position of the vernier. In Figure 1408a the reading is 29° 42.5'. The arrow on the index mark is between 29° and 30°, the zero on the vernier is between 42' and 43', and the 0.5' graduation on the vernier coincides with one of the graduations on the micrometer drum.

The principle of reading a vernier sextant is the same, but the reading is made in two steps. Figure 1408b shows a typical altitude setting. Each degree on the arc of this sextant is graduated into three parts, permitting an initial reading by the reference mark on the index arm to the nearest 20' of arc. In this illustration the reference mark lies between 76° 20' and 76° 40', indicating a reading between these values. The reading for the fraction between 20' and 40' is made using the vernier, which is engraved on the index arm and has the small reference mark as its zero graduation. On this vernier, 20 graduations coincide with 19 graduations on the arc. Each graduation on the vernier is equivalent to 1/20 of one graduation of 20' on the arc, or 0.5', or 30". In the illustration, the vernier graduation representing 6' most nearly coincides with one of the graduations on the arc. Therefore, the reading is 76° 20' + 6' 00" or 76° 26' 00". When a vernier of this type is used, any doubt as to which mark on the vernier coincides with a graduation on the arc can usually be resolved by noting the position of the vernier mark on each side of the one that seems to be in coincidence.

Negative readings, such as a negative index correction, are made in the same manner as positive readings; the various figures are added algebraically. Thus, if the three parts of a micrometer drum reading are (-)1°, 56' and 0.3', the total reading is (-)1° + 56' + 0.3' = (-)3.7'.

1409. Developing Observational Skill

A well-constructed marine sextant is capable of measuring angles with an instrument error not exceeding 0.1'. Lines of position from altitudes of this accuracy would not be in error by more than about 200 yards. However, there are various sources of error, other than instrumental, in altitudes measured by sextant. One of the principal sources is the observer.

The first fix a student celestial navigator plots is likely to be disappointing. Most navigators require a great amount of practice to develop the skill necessary for consistently good observations. But practice alone is not sufficient. Good technique should be developed early and refined

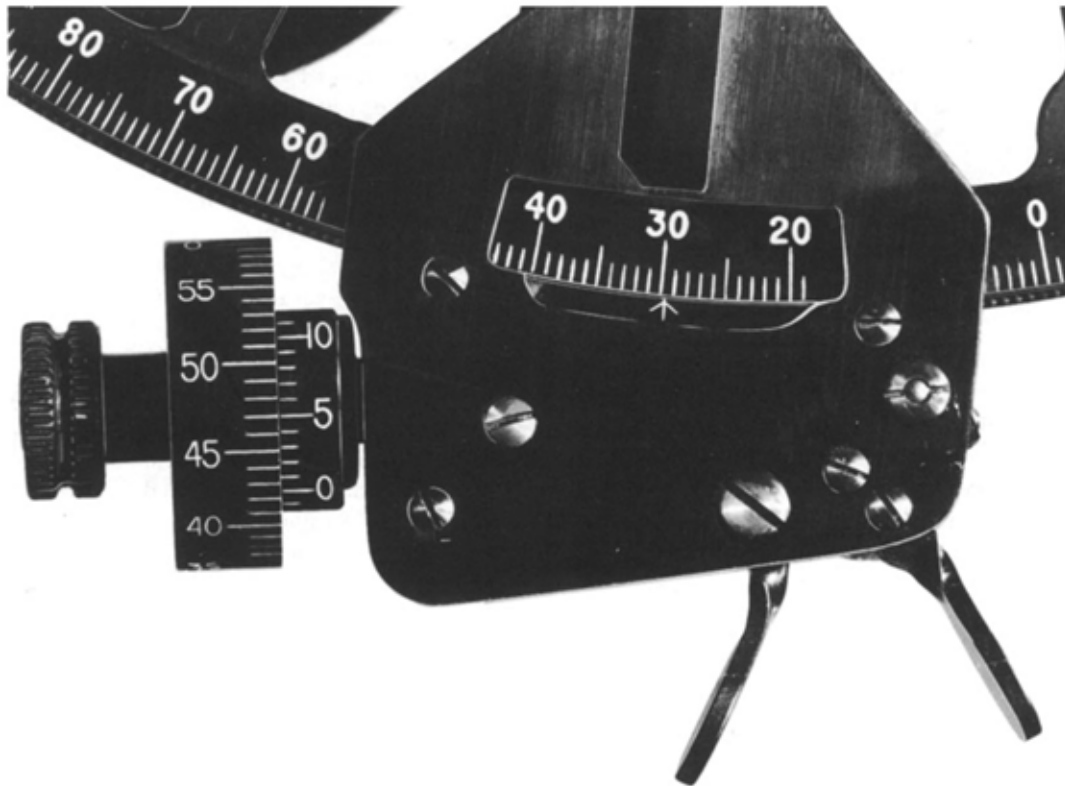

Figure 1408a. Micrometer drum sextant set at $29^{\circ} 42.5'$.

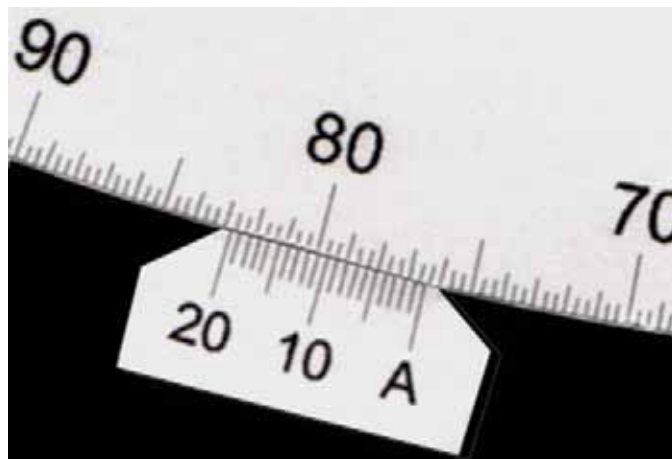

Figure 1408b. Vernier sextant set at $76^{\circ} 26' 00''$. Image courtesy of Omar F. Reis.

throughout the navigator's career. Many good pointers can be obtained from experienced navigators, but each student navigator must develop his or her own technique because one method proves successful for one observer may not be helpful to another. Also, experienced navigators have a natural tendency to judge the accuracy of their observations solely by the size of the

figure formed with the intersection of the plotted lines of position. Although a small area of intersection (or a "tight fix") may be present, it may not necessarily be an accurate reflection of the ship's position if individual observation errors are allowed to be introduced. There are many errors, some of which are beyond the navigator's control. Therefore, lines of position from celestial observations

should be compared often with accurate position obtained by electronics or piloting.

Common sources of error are:

1. Time errors.
2. Sextant adjustment.
3. Improper rocking of the sextant.
4. The height of eye input may be wrong.
5. Index correction computation errors.
6. Subnormal refraction (dip) might be present.
7. Inaccurate judgment of tangency.
8. Using a false horizon.
9. Other computation errors.

Generally, it is possible to correct observation technique errors, but occasionally a personal error will persist. This error might vary as a function of the body observed, degree of fatigue of the observer, and other factors. For this reason, a personal error should be applied with caution.

To obtain greater accuracy, take a number of closely-spaced observations. Plot the resulting altitudes versus time and draw a curve through the points. Unless the body is near the celestial meridian, this curve should be a straight line. Use this graph to determine the altitude of the body at any time covered by the graph. It is best to use a point near the middle of the line. Using a navigational calculator, computer program, or app to reduce sights will yield greater accuracy because of the rounding errors inherent in the use of sight reduction tables, and because many more sights can be reduced in a given time, thus averaging out errors.

A simpler method involves making observations at equal intervals. This procedure is based upon the assumption that, unless the body is on the celestial meridian, the change in altitude should be equal for equal intervals of time. Observations can be made at equal intervals of altitude or time. If time intervals are constant, the mid time and the average altitude are used as the observation. If altitude increments are constant, the average time and mid altitude are used.

If only a small number of observations is available, reduce and plot the resulting lines of position; then adjust them to a common time. The average position of the line might be used, but it is generally better practice to use the middle line. Reject any observation considered unreliable when determining the average.

1410. Care of the Sextant

A sextant is a rugged instrument. However, careless handling or neglect can cause it irreparable harm. If you drop it, take it to an instrument repair shop for testing and inspection. When not using the sextant, stow it in a sturdy and sufficiently padded case. Keep the sextant away from excessive heat and dampness. Do not expose it to excessive vibration. Do not leave it unattended when it is out of its case. Do not hold it by its limb, index arm, or telescope. Lift

it only by its frame or handle. Do not lift it by its arc or index bar.

Next to careless handling, moisture is the sextant's greatest enemy. Wipe the mirrors and the arc after each use. If the mirrors get dirty, clean them with lens paper and a small amount of alcohol. Clean the arc with ammonia; never use a polishing compound. When cleaning, do not apply excessive pressure to any part of the instrument.

Silica gel kept in the sextant case will help keep the instrument free from moisture and preserve the mirrors. Occasionally heat the silica gel to remove the absorbed moisture.

Rinse the sextant with fresh water if sea water gets on it. Wipe the sextant gently with a soft cotton cloth and dry the optics with lens paper.

Glass optics do not transmit all the light received because glass surfaces reflect a small portion of light incident on their face. This loss of light reduces the brightness of the object viewed. Viewing an object through several glass optics affects the perceived brightness and makes the image indistinct. The reflection also causes glare which obscures the object being viewed. To reduce this effect to a minimum, the glass optics are treated with a thin, fragile, anti-reflection coating. Therefore, apply only light pressure when polishing the coated optics. Blow loose dust off the lens before wiping them so grit does not scratch the lens.

Occasionally, oil and clean the tangent screw and the teeth on the side of the limb. Use the oil provided with the sextant or an all-purpose light machine oil. Occasionally set the index arm of an endless tangent screw at one extremity of the limb, oil it lightly, and then rotate the tangent screw over the length of the arc. This will clean the teeth and spread oil over them. When stowing a sextant for a long period, clean it thoroughly, polish and oil it, and protect its arc with a thin coat of petroleum jelly. If the mirrors need re-silvering, take the sextant to an instrument shop.

1411. Non Adjustable Sextant Errors

The non-adjustable sextant errors are prismatic error, graduation error, and centering error. The higher the quality of the instrument, the less these error will be.

Prismatic error occurs when the faces of the shade glasses and mirrors are not parallel. Error due to lack of parallelism in the shade glasses may be called **shade error**. The navigator can determine shade error in the shade glasses near the index mirror by comparing an angle measured when a shade glass is in the line of sight with the same angle measured when the glass is not in the line of sight. In this manner, determine and record the error for each shade glass. Before using a combination of shade glasses, determine their combined error. If certain observations require additional shading, use the colored telescope eyepiece cover. This does not introduce an error because direct and reflected rays are traveling together

when they reach the cover and are, therefore, affected equally by any lack of parallelism of its two sides.

Graduation errors occur in the arc, micrometer drum, and vernier of a sextant which is improperly cut or incorrectly calibrated. Normally, the navigator cannot determine whether the arc of a sextant is improperly cut, but the principle of the vernier makes it possible to determine the existence of graduation errors in the micrometer drum or vernier. This is a useful guide in detecting a poorly made instrument. The first and last markings on any vernier should align perfectly with one less graduation on the adjacent micrometer drum.

Centering error results if the index arm does not pivot at the exact center of the arc's curvature. Calculate centering error by measuring known angles after removing all adjustable errors. Use horizontal angles accurately measured with a theodolite as references for this procedure. Several readings by both theodolite and sextant should minimize errors. If a theodolite is not available, use calculated angles between the lines of sight to stars as the reference, comparing these calculated values with the values determined by the sextant. To minimize refraction errors, select stars at about the same altitude and avoid stars near the horizon. The same shade glasses, if any, used for determining index error should be used for measuring centering error.

The manufacturer normally determines the magnitude of all three non-adjustable errors and reports them to the user as **instrument error**. The navigator should apply the correction for this error to each sextant reading.

1412. Adjustable Sextant Error

The navigator should measure and remove the following adjustable sextant errors in the order listed:

1. **Perpendicularity Error:** Adjust first for perpendicularity of the index mirror to the frame of the sextant. To test for perpendicularity, place the index arm at about 35° on the arc and hold the sextant on its side with the index mirror up and toward the eye. Observe the direct and reflected views of the sextant arc, as illustrated in Figure 1412a. If the two views are not joined in a straight line, the index mirror is not perpendicular. If the reflected image is above the direct view, the mirror is inclined forward. If the reflected image is below the direct view, the mirror is inclined backward. Make the adjustment using two screws behind the index mirror.

2. **Side Error:** An error resulting from the horizon glass not being perpendicular to the frame is called **side error**. To test for side error, set the index arm at zero and direct the line of sight at a star. Then rotate the tangent screw back and forth so that the reflected image passes alternately above and below the direct view. If, in changing from one position to the other, the reflected image passes directly over the unreflected image, no side error exists. If it passes to one side, side error exists. Figure 1412b illustrates observations without side error (left) and with side error (right). Whether the sextant reads zero when the true and reflected images are in coincidence is immaterial for this test. An alternative method is to observe a vertical line, such as one edge of the mast of another vessel (or the sextant can be held on its side and the horizon used). If the direct and reflected portions do not form a continuous line, the horizon glass is not perpendicular to the frame of the sextant. A third method in-

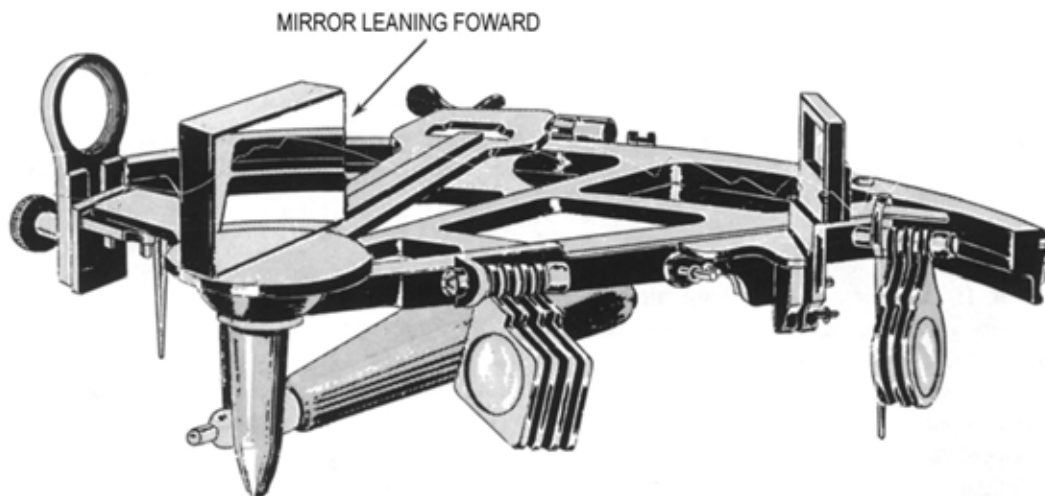

Figure 1412a. Testing the perpendicularity of the index mirror. Here the mirror is not perpendicular.

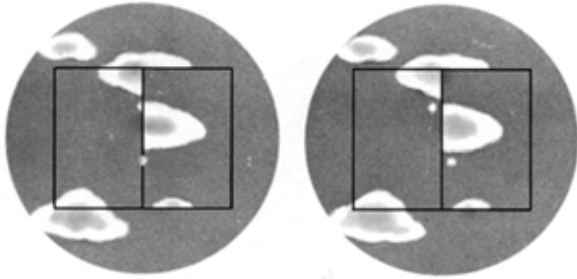

Figure 1412b. Testing the perpendicularity of the horizon glass. On the left, side error does not exist. At the right, side error does exist.

involves holding the sextant vertically, as in observing the altitude of a celestial body. Bring the reflected image of the horizon into coincidence with the direct view until it appears as a continuous line across the horizon glass. Then tilt the sextant right or left. If the horizon still appears continuous, the horizon glass is perpendicular to the frame, but if the reflected portion appears above or below the part seen directly, the glass is not perpendicular. Make the appropriate adjustment using two screws behind the horizon glass.

3. **Collimation Error:** If the line of sight through the telescope is not parallel to the plane of the instrument, a **collimation error** will result. Altitudes measured will be greater than their actual values. To check for parallelism of the telescope, insert it in its collar and observe two stars 90° or more apart. Bring the reflected image of one into coincidence with the direct view of the other near either the right or left edge of the field of view (the upper or lower edge if the sextant is horizontal). Then tilt the sextant so that the stars appear near the opposite edge. If they remain in coincidence, the telescope is parallel to the frame; if they separate, it is not. An alternative method involves placing the telescope in its collar and then laying the sextant on a flat table. Sight along the frame of the sextant and have an assistant place a mark on the opposite bulkhead, in line with the frame. Place another mark above the first, at a distance equal to the distance from the center of the telescope to the frame. This second line should be in the center of the field of view of the telescope if the telescope is parallel to the frame. Adjust the collar to correct for non-parallelism.

4. **Index Error:** Index error is the error remaining after the navigator has removed perpendicularity error, side error, and collimation error. The index mirror and horizon glass not being parallel when the index arm is set exactly at zero is the major cause of index error. To test for parallelism of the mirrors, set the instrument at zero and direct the line of sight at the horizon. Adjust the sextant reading as necessary to cause both images of the horizon to come into line. The sextant's reading when the horizon comes into line is the index error. If the index error is positive, subtract it from each sextant reading. If the index error is negative, add it to each sextant

reading.

1413. Selecting a Sextant

Carefully match the selected sextant to its required uses. For occasional small craft or student use, a plastic sextant may be adequate. A plastic sextant may also be appropriate for an emergency navigation kit. Accurate offshore navigation requires a quality metal instrument. For ordinary use in measuring altitudes of celestial bodies, an arc of 90° or slightly more is sufficient. If back sights or determining horizontal angles are often required, purchase one with a longer arc. An experienced mariner or nautical instrument technician can provide valuable advice on the purchase of a sextant.

1414. The Artificial Horizon

Measurement of altitude requires an exact horizontal reference, normally provided at sea by the visible horizon. If the horizon is not clearly visible, however, a different horizontal reference is required. Such a reference is commonly termed an **artificial horizon**. If it is attached to, or part of, the sextant, altitudes can be measured at sea, on land, or in the air, whenever celestial bodies are available for observations.

An external artificial horizon can be improvised by a carefully leveled mirror or a pan of dark liquid. To use an external artificial horizon, stand or sit so that the celestial body is reflected in the mirror or liquid, and is also visible in direct view. With the sextant, bring the double-reflected image into coincidence with the image appearing in the liquid. For a lower limb observation of the Sun or the Moon, bring the bottom of the double-reflected image into coincidence with the top of the image in the liquid. For an upper-limb observation, bring the opposite sides into coincidence. If one image covers the other, the observation is of the center of the body.

After the observation, apply the index correction and any other instrumental correction. Then take *half* the remaining angle and apply all other corrections except dip (height of eye) correction, since this is not applicable. If the center of the Sun or Moon is observed, omit the correction for semidiameter.

1415. Artificial Horizon Sextants

Various types of artificial horizons have been used, including a bubble, gyroscope, and pendulum. Of these, the bubble has been most widely used. This type of instrument is fitted as a backup system to inertial and other positioning systems in a few aircraft, fulfilling the requirement for a self-contained, non-emitting system. On land, a skilled observer using a 2-minute averaging bubble or pendulum sextant can measure altitudes to an accuracy of perhaps $2'$, (2 miles). This, of course, refers to the accuracy of measurement only, and does not include additional errors such as abnormal refraction, deflection of the vertical, computing and plotting errors, etc. In steady flight through smooth air the error of a 2-minute observation is increased to perhaps 5 to 10 miles.

At sea, with virtually no roll or pitch, results should approach those on land. However, even a gentle roll causes large errors. Under these conditions observational errors of 10-16 miles are not unreasonable. With a moderate sea, errors of 30 miles or more are common. In a heavy sea, any useful observations are virtually impossible to obtain. Single altitude observations in a moderate sea can be in error by a matter of degrees.

When the horizon is obscured by ice or haze, polar navigators can sometimes obtain better results with an artificial-horizon sextant than with a marine sextant. Some artificial-horizon sextants have provision for making

observations with the natural horizon as a reference, but results are not generally as satisfactory as by marine sextant. Because of their more complicated optical systems, and the need for providing a horizontal reference, artificial-horizon sextants are generally much more costly to manufacture than marine sextants.

Altitudes observed by artificial-horizon sextants are subject to the same errors as those observed by marine sextant, except that the dip (height of eye) correction does not apply. Also, when the center of the Sun or Moon is observed, no correction for semidiameter is required.

CHRONOMETERS

1416. The Marine Chronometer

Historically, the spring-driven **marine chronometer** was a precision timepiece used aboard ship to provide accurate time for celestial observations. A chronometer differs from a spring-driven watch principally in that it contains a variable lever device to maintain even pressure on the mainspring, and a special balance designed to compensate for temperature variations. Today, many seagoing ships no longer have chronometers on board due to highly accurate time signals provided by GPS.

A spring-driven chronometer is set approximately to **Coordinated Universal Time (UTC)**, also referred to as **Greenwich Mean Time (GMT)**, or **Universal Time (UT)**, which is the international time standard used in astronomical and aviation publications, weather products, navigation, and other applications. UTC is expressed in 24-hour (military) time notation, and as with GMT it is based on the local standard time of the 0° longitude meridian which runs through Greenwich, England. A spring-driven chronometer, once set, is not reset until the instrument is overhauled and cleaned, usually at three year intervals.

The difference between UTC and chronometer time (C) is carefully determined and applied as a correction to all chronometer readings. This difference, called chronometer error (CE), is **fast (F)** if chronometer time is later than UTC, and **slow (S)** if earlier. The amount by which chronometer error changes in 1 day is called **chronometer rate**. An erratic rate indicates a defective instrument requiring repair.

The principal maintenance requirement is regular winding at about the same time each day. At maximum intervals of about three years, a spring-driven chronometer should be sent to a chronometer repair shop for cleaning and overhaul.

1417. Quartz Crystal Marine Chronometers

Quartz crystal marine chronometers have replaced spring-driven chronometers aboard many ships because of their greater accuracy. They are maintained on UTC directly from radio time signals. This eliminates chronometer error

(CE) and watch error (WE) corrections. Should the second hand be in error by a readable amount, it can be reset electrically.

The basic element for time generation is a quartz crystal oscillator. The quartz crystal is temperature compensated and is hermetically sealed in an evacuated envelope. A calibrated adjustment capability is provided to adjust for the aging of the crystal.

The chronometer is designed to operate for a minimum of 1 year on a single set of batteries. A good marine chronometer has a built-in push button battery test meter. The meter face is marked to indicate when the battery should be replaced. The chronometer continues to operate and keep the correct time for at least 5 minutes while the batteries are changed. The chronometer is designed to accommodate the gradual voltage drop during the life of the batteries while maintaining accuracy requirements.

1418. Watches

A chronometer should not be removed from its case to time sights. Observations may be timed and ship's clocks set with a **comparing watch**, which is set to chronometer time (UTC, GMT, also known as UT) and taken to the bridge wing for recording sight times. In practice, a wrist watch coordinated to the nearest second with the chronometer will be adequate.

A stop watch, either spring wound or digital, may also be used for celestial observations. In this case, the watch is started at a known UTC by chronometer, and the elapsed time of each sight added to this to obtain UT of the sight.

All chronometers and watches should be checked regularly with a radio time signal. Times and frequencies of radio time signals are listed in NGA *Pub. 117, Radio Navigational Aids*.

1419. Navigational Calculators

While not considered "instruments" in the strict sense of the word, certainly one of the professional navigator's most useful tools is the navigational calculator or computer

program. Calculators eliminate several potential sources of error in celestial navigation, and permit the solution of many more sights in much less time, making it possible to refine a celestial position much more accurately than is practical using mathematical or tabular methods.

Calculators also save space and weight, a valuable consideration on many craft. One small calculator can replace several heavy and expensive volumes of tables, and is inexpensive enough that there is little reason not to carry a spare for backup use should the primary one fail. The pre-programmed calculators are at least as robust in construction, probably more so, than the sextant itself, and when properly cared for will last a lifetime with no maintenance except, to change batteries from time to time.

If the vessel carries a computer for other ship's chores such as inventory control or personnel administration, there is little reason not to use it for celestial navigation. Free-ware or inexpensive programs are available which take up little hard disk space and allow rapid solution of all types of celestial navigation problems. Typically they will also take care of route planning, sailings, tides, weather routing, electronic charts, and numerous other tasks.

U.S. Navy and Coast Guard navigators have access to a program called **STELLA (System To Estimate Latitude**

and Longitude Astronomically; do not confuse with a similarly named commercial astronomy program). The Astronomical Applications Department of the U.S. Naval Observatory developed STELLA in response to a Navy requirement. STELLA can perform almanac functions, position updating/DR estimations, celestial body rise/set/transit calculations, compass error calculations, sight planning, and sight reduction; on-line help and a user's guide are included. STELLA is now automatically distributed to each Naval ship; other Navy users may obtain a copy by contacting:

Superintendent
U.S. Naval Observatory
Code: AA/STELLA
3450 Massachusetts Ave. NW
Washington, DC, 20392-5420

By using a calculator or sight reduction program, it is possible to take and solve half a dozen or more sights in a fraction of the time it would normally take to shoot two or three and solve them by hand. This will increase the accuracy of the fix by averaging out errors in taking the sights. The computerized solution is always more accurate than tabular methods because it is free of rounding and arithmetic errors.

CHAPTER 15

AZIMUTHS AND AMPLITUDES

INTRODUCTION

1500. Checking Compass Error

The navigator must constantly be concerned about the accuracy of the ship's primary and backup compasses, and should check them regularly. A regularly annotated compass log book will allow the navigator to notice a developing error before it becomes a serious problem.

As long as at least two different types of compass (e.g. mechanical gyro and flux gate, or magnetic and ring laser gyro) are consistent with each other, one can be reasonably sure that there is no appreciable error in either system. Since different types of compasses depend on different scientific principles and are not subject to the same error sources, their agreement indicates almost certainly that no error is present.

A navigational compass can be checked against the heading reference of an inertial navigation system if one is installed. One can also refer to the ship's indicated GPS track as long as current and leeway are not factors, so that the ship's COG and heading are in close agreement.

The navigator's only completely independent directional reference (because it is extra-terrestrial and not man-made) is the sky. The primary compass should be

checked occasionally by comparing the observed and calculated azimuths and amplitudes of a celestial body. The difference between the observed and calculated values is the compass error. This chapter discusses these procedures.

Theoretically, these procedures work with any celestial body. However, the Sun and Polaris are used most often when measuring azimuths, and the rising or setting Sun when measuring amplitudes.

While errors can be computed to the nearest tenth of a degree or so, it is seldom possible to steer a ship that accurately, especially when a sea is running, and it is reasonable to round calculations to the nearest half or perhaps whole degree for most purposes.

Various hand-held calculators and computer programs are available to relieve the tedium and errors of tabular and mathematical methods of calculating azimuths and amplitudes. Naval and Coast Guard navigators will find the STELLA program useful in this regard. This program is discussed in further in Chapter 19 - Sight Reductions. STELLA stands for the System to Establish Latitude and Longitude Astronomically.

AZIMUTHS

1501. Gyro Error by Azimuth of the Sun

Mariners not having STELLA may use *Pub 229, Sight Reduction Tables for Marine Navigation* to compute the Sun's azimuth. They compare the computed azimuth to the azimuth measured with the compass to determine compass error. In computing an azimuth, interpolate the tabular azimuth angle for the difference between the table arguments and the actual values of declination, latitude, and local hour angle. Do this triple interpolation of the azimuth angle as follows:

1. Enter the *Sight Reduction Tables* with the integer values of declination, latitude, and local hour angle. For each of these arguments, extract a base azimuth angle.
2. Reenter the tables with the same latitude and LHA arguments but with the **declination** argument 1° greater than the base declination argument. Record the difference between the respondent azimuth

angle and the base azimuth angle and label it as the azimuth angle difference (Z Diff.).

3. Reenter the tables with the base declination and LHA arguments, but with the **latitude** argument 1° greater than the base latitude argument. Record the Z Diff. for the increment of latitude.
4. Reenter the tables with the base declination and latitude arguments, but with the LHA argument 1° greater than the base LHA argument. Record the Z Diff. for the increment of LHA.
5. Determine the increment of each of the three arguments, which is simply the actual minus the base argument. Use this to compute a correction for each of the three arguments, using the formula $\text{Correction} = \text{Z Diff.} \times (\text{increment} \div 60)$.
6. Sum the three corrections to obtain a total correction. Apply this to the base azimuth angle to obtain the true azimuth angle.

The gyrocompass error is the difference between the true azimuth angle (Zn) and the measured azimuth angle per gyrocompass (Zn pgc). The gyro error is West if the gyro reads a larger value than true; it is East if the gyro reading is the smaller value. One way to remember this is “gyro

best, error West; gyro least, error East.” (Be careful of this mnemonic near the 360°/0° boundary, though, where a value slightly larger than 0° is actually treated as slightly larger than 360°.)

	Actual	Base Arguments	Base Z	Tab* Z	Z Diff.	Increments	Correction Z Diff x (Inc.÷ 60)
Dec.	8°47.4' S	8°	121.3°	122.3°	+1.0°	47.4'	+0.8°
DR Lat.	23°55.0' N	23°(Contrary)	1213°	122.0°	+0.7°	55.0'	+0.6°
LHA	317°37.4'	317°	1213°	122.1°	+0.8°	37.4'	+0.5°
						Total Corr.	+1.9°

Base Z	121.3°
Corr.	(+) 1.9°
Z	N 121.3°E
Zn	123.2°
Zn pgc	124.0°
Gyro Error	0.8° W

*Respondent for the two base arguments and 1° change from third base argument, in vertical order of Dec., DR Lat., and LHA.

Figure 1501. Azimuth by Pub. No. 229.

Example:

In DR latitude 23° 55.0'N, the azimuth of the Sun is 124.0° per gyrocompass (pgc). At the time of the observation, the declination of the Sun is 8° 47.4'S; the local hour angle of the Sun is 317° 37.4. Determine gyro error.

Solution:

(See Figure 1501) Enter the actual value of declination, DR latitude, and LHA. Round each argument down to the nearest whole degree. Enter the Sight Reduction Tables with these whole degree arguments and extract the base azimuth value for these rounded off arguments. Record the base azimuth value in the table.

As the first step in the triple interpolation process, increase the value of the declination by 1° to 9° because the actual declination was greater than the base declination. Enter the Sight Reduction Tables with the following arguments: (1) Declination = 9°; (2) DR Latitude = 23°; (3) LHA = 317°. Record the tabulated azimuth for these arguments.

As the second step in the triple interpolation process, increase the value of latitude by 1° to 24° because the actual DR latitude was greater than the base latitude. Enter the Sight Reduction Tables with the following arguments: (1) Declination = 8°; (2) DR Latitude = 24°; (3) LHA =

317°. Record the tabulated azimuth for these arguments.

As the third and final step in the triple interpolation process, increase the value of LHA to 318° because the actual LHA value was greater than the base LHA. Enter the Sight Reduction Tables with the following arguments: (1) Declination = 8°; (2) DR Latitude = 23°; (3) LHA = 318°. Record the tabulated azimuth for these arguments.

Calculate the Z Difference by subtracting the base azimuth from the tabulated azimuth. Be careful to carry the correct sign.

$$Z \text{ Difference} = \text{Tab Z} - \text{Base Z}$$

Next, determine the increment for each argument by taking the difference between the actual values of each argument and the base argument. Calculate the correction for each of the three argument interpolations by dividing the increment by 60, and multiplying the result by the Z difference.

The sign of each correction is the same as the sign of the corresponding Z difference used to calculate it. In the above example, the total correction sums to +1.9. Apply this value to the base azimuth of 121.3° to obtain the true azimuth 123.2°. Compare this to the gyrocompass reading of 124.0° pgc. The compass error is 0.8°W.

AZIMUTH OF POLARIS

1502. Gyro Error by Azimuth of Polaris

The Polaris tables in the *Nautical Almanac* list the azimuth of Polaris for latitudes between the equator and 65° N. Figure 1912b in Chapter 19 shows this table. Compare a compass bearing of Polaris to the tabular value of Polaris to determine compass error. The entering arguments for the table are LHA of Aries and observer latitude.

Example:

On February 23, 2016, at LAT 29°31.0' N and LON 074°30.0'W, at 04-21-15 GMT, Polaris bears 359.9° pgc. Calculate the gyro error.

Date 23 February 2016
 Time (GMT) 04-21-15

GHA Aries 217° 49.3' (from almanac daily pages & interpolation)
 Longitude 074° 30.0'W
 LHA Aries 143° 19.3'

down and extract the value for the given latitude. Since the increment between tabulated values is so small, visual interpolation is sufficient. In this case, the azimuth for Polaris for the given LHA of Aries and the given latitude is 359.2°.

Solution:

Enter the azimuth section of the Polaris table with the calculated LHA of Aries. In this case, go to the column for LHA Aries between 140° and 149°. Follow that column

Tabulated Azimuth 359.2°T
 Gyrocompass Bearing 359.9°T
 Error 0.7°W

AMPLITUDES

1503. Amplitudes

A celestial body's amplitude angle is the complement of its azimuth angle. At the moment that a body rises or sets, the amplitude angle is the arc of the horizon between the

body and the East/West point of the horizon where the observer's prime vertical intersects the horizon (at 90°), which is also the point where the plane of the equator intersects the horizon (at an angle numerically equal to the observer's co-latitude). See Figure 1503.

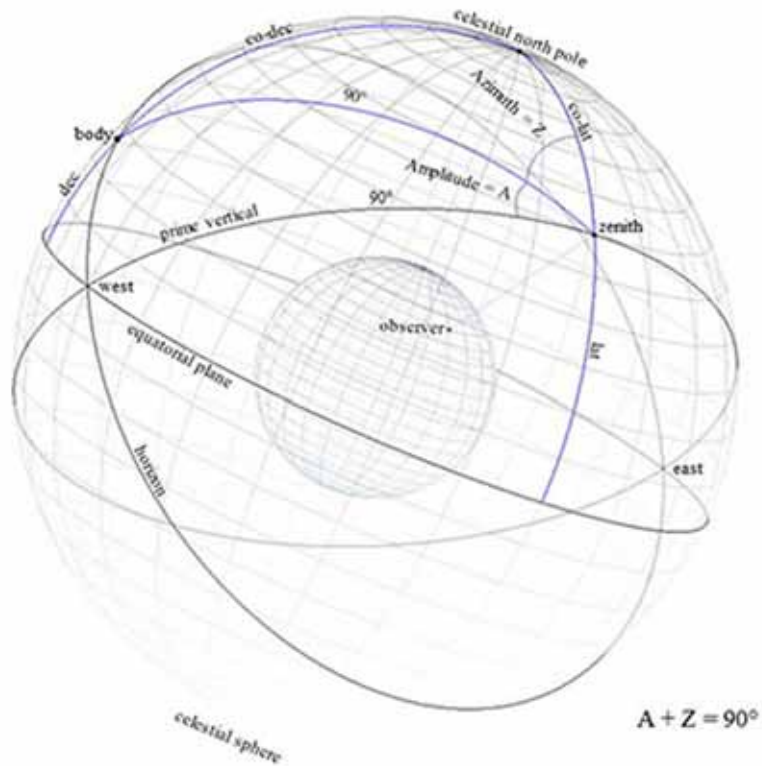

Figure 1503. The amplitude angle (A) subtends the arc of the horizon between the body and the point where the prime vertical and the equator intersect the horizon. Note that it is the complement of the azimuth angle (Z).

In practical navigation, a bearing (psc or pgc) of a body can be observed when it is on either the celestial or the visible horizon. To determine compass error, simply convert the computed amplitude angle to true degrees and compare it with the observed compass bearing.

The angle is computed by the formula:

$$\sin A = \sin Dec / \cos Lat.$$

This formula gives the angle at the instant the body is on the celestial horizon. It does not contain an altitude term because the body's computed altitude is zero at this instant.

The angle is prefixed E if the body is rising and W if it is setting. This is the only angle in celestial navigation referenced FROM East or West, i.e. from the prime vertical. A body with northerly declination will rise and set

North of the prime vertical. Likewise, a body with southerly declination will rise and set South of the prime vertical. Therefore, the angle is suffixed N or S to agree with the name of the body's declination. A body whose declination is zero rises and sets exactly on the prime vertical.

Due largely to refraction, dip, and its disk size, the Sun is on the celestial horizon when its lower limb is approximately two thirds of a diameter above the visible horizon. The Moon is on the celestial horizon when its upper limb is on the visible horizon. Stars and planets are on the celestial horizon when they are approximately one Sun diameter above the visible horizon.

When observing a body on the visible horizon, a correction from Table 23 - *Correction of Amplitude as Observed on the Visible Horizon* must be applied. This correction accounts for the slight change in bearing as the body moves between the visible and celestial horizons. It reduces the bearing on the visible horizon to the celestial horizon, from which the table is computed.

For the Sun, stars, and planets, apply this correction to the observed bearing in the direction away from the elevated pole. For the moon, apply one half of the correction toward the elevated pole. Note that the algebraic sign of the correction does not depend upon the body's declination, but only on the observer's latitude. Assuming the body is the Sun the rule for applying the correction can be outlined as follows:

Observer's Lat.	Rising/Setting	How to Apply Correction
North	Rising	Add correction to observed bearing
North	Setting	Subtract correction from observed bearing
South	Rising	Subtract correction from observed bearing
South	Setting	Add correction to observed bearing

Table 1503. Amplitude correction for the Sun.

The following two articles demonstrate the procedure for obtaining the amplitude of the Sun on both the celestial and visible horizons.

1504. Amplitude of the Sun on the Celestial Horizon

Mariners may use Bowditch Table 22 (Amplitudes) to determine the Sun's computed amplitude. The procedure is similar to that done in Section 1501. Comparing the computed amplitude to the amplitude measured with the gyrocompass determines the gyro error. In computing an amplitude, interpolate the tabular amplitude angle for the difference between the table arguments and the actual values of declination and latitude.

Do this double interpolation of the amplitude angle as

follows:

- Enter Bowditch Table 22 (Amplitudes) with the nearest integral values of declination and latitude. Extract a base amplitude angle.
- Reenter the table with the same declination argument but with the latitude to the next tabulated value (greater or less than the base latitude argument, depending upon whether the actual latitude is greater or less than the base argument). Record the amplitude and the difference between it and the base amplitude angle and label it Diff.
- Reenter the table with the base latitude argument but with the declination to the next tabulated value (greater or less than the base declination argument, depending upon whether the actual declination is greater or less than the base argument). Record the amplitude and the difference between it and the base amplitude angle and label it Diff.
- Compute the corrections due to latitude and declination not being exactly at a tabular value. Apply these corrections to obtain a final amplitude. The final amplitude is then converted to a true bearing. The difference between the true bearing and the gyro bearing gives the gyro error.

Example:

The DR latitude of a ship is 51° 24.6' N. The navigator observes the setting Sun on the celestial horizon. Its declination is N 19° 40.4'. Its observed bearing is 303° pgc.

Required:

Gyro error.

Solution:

Interpolate in Table 22 for the Sun's calculated amplitude as follows. See Figure 1504. The actual values for latitude and declination are L = 51.4° N and dec. = 19.67°. Find the tabulated values of latitude and declination closest to these actual values. In this case, these tabulated values are L = 51° and dec. = 19.5°. Record the amplitude corresponding to these base values, 32.0°, as the base amplitude.

Next, holding the base declination value constant at 19.5°, increase the value of latitude to the next tabulated value: N 52°. Note that this value of latitude was increased because the actual latitude value was greater than the base value of latitude. Record the tabulated amplitude for L = 52° and dec. = 19.5°: 32.8°. Then, holding the base latitude value constant at 51°, increase the declination value to the next tabulated value: 20°. Record the tabulated amplitude for L = 51° and dec. = 20°: 32.9°.

The latitude's actual value (51.4°) is 0.4 of the way between the base value (51°) and the value used to determine the tabulated amplitude (52°). The declination's actual value (19.67°) is 0.3 of the way between the base value (19.5°) and the value used to determine the tabulated amplitude

(20.0°). To determine the total correction to base amplitude, multiply these increments (0.4 and 0.3) by the respective difference between the base and tabulated values (+0.8 and +0.9, respectively) and sum the products. The total correction is +0.6°. Add the total correction (+0.6°) to the base amplitude (32.0°) to determine the final amplitude (32.6°) which will be converted to a true bearing.

Because of its northerly declination (in this case), the Sun was 32.6° north of west when it was on the celestial horizon. Therefore its true bearing was 302.6° (270° + 32.6°) at this moment. Comparing this with the gyro bearing of 303° gives an error of 0.4°W, which can be rounded to 1/2°W.

Actual	Base	Base Amp.	Tab. Amp.	Diff.	Inc.	Correction
L=51.4°N	51°	32.0°	32.8°	+0.8°	0.4	+0.3°
dec=19.67°N	19.5°	32.0°	32.9°	+0.9°	0.3	<u>+0.3°</u>
Total						+0.6°

Figure 1504. Interpolation in Table 22 for Amplitude.

1505. Amplitude of the Sun on the Visible Horizon

In higher latitudes, amplitude observations should be made when the body is on the visible horizon because the value of the correction is large enough to cause significant error if the observer misjudges the exact position of the celestial horizon. The observation will yield precise results whenever the visible horizon is clearly defined.

Example:

Observer's DR latitude is 59°47'N, Sun's declination is 5°11.3'S. At sunrise the Sun is observed on the visible horizon bearing 098.5° pgc.

Required:

Gyrocompass error.

Solution:

Given this particular latitude and declination, the amplitude angle is 10.3°S, so that the Sun's true bearing is 100.3° at the moment it is on the celestial horizon, that is, when its Hc is precisely 0°. Applying the Table 23 correction to the observed bearing of 098.5° pgc using the rules given in Section 1503, the Sun would have been bearing 099.7° pgc had the observation been made when the Sun was on the celestial horizon. Therefore, the gyro error is 0.6°E.

1506. Amplitude by Calculation

As an alternative to using the amplitude tables, if a calculator is available then the amplitudes can be computed using a slightly modified version of the altitude-azimuth formula. The modification is needed because azimuth (Z) and amplitude (A) angles are complimentary, and the co-functions of complimentary angles are equal; i.e., cosine Z = sine A. In the following formulas, northerly latitudes and declinations are given positive values, and southerly latitudes and declinations are considered negative. If the

resulting amplitude is positive, it is north of the prime vertical; conversely, a negative amplitude is south of the prime vertical.

- a) The general case, when a body is not on the celestial horizon, the formula is:

$$\text{Amplitude} = \sin^{-1}[(\sin \text{DEC} - \sin \text{LAT} \sin \text{Hc}) / (\cos \text{LAT} \cos \text{Hc})]$$

where DEC is the celestial body's declination, LAT is the observer's latitude, and Hc is the object's computed altitude. For the Sun on the visible horizon, Hc = -0.7°.

- b) When a body is on the celestial horizon (that is, its altitude, Hc = 0), the formula becomes:

$$\text{Amplitude} = \sin^{-1} [\sin \text{DEC} / \cos \text{LAT}]$$

Example:

Determine the gyrocompass error using the formulation instead of the tables, for the example in Section 1505.

Required:

Gyrocompass error.

Solution:

The observed bearing of the Sun on the visible horizon is 098.5° pgc. The computed amplitude of the Sun when it is on the visible horizon (that is, Hc = -0.7°) is found by:

$$\text{Amplitude} = \sin^{-1} [(\sin -5.19^\circ - \sin 59.78^\circ \sin -0.7^\circ) / (\cos 59.78^\circ \cos -0.7^\circ)].$$

Evaluating, we find the amplitude is 9.1°. This is 9.1° degrees away from E, in the "negative" (or southerly) direction, so the calculated azimuth is 90° + 9.1° = 99.1°. The gyrocompass error is 99.1° - 98.5° = 0.6° E. This value matches the answer obtained in Section 1505 using the tables.

CHAPTER 16

TIME

TIME IN NAVIGATION

1600. Apparent and Solar Time

The Earth's rotation on its axis presents the Sun and other celestial bodies to appear to proceed across the sky from east to west each day. If a navigator measures the time interval between two successive transits across the local meridian of a very distant star by the passage of time against another physical time reference such as a chronometer, he or she would be measuring the period of the Earth's rotation.

In the most practical sense, the Earth's rotation is the navigator's standard of time. When the navigator then

makes a similar measurement of the transit of the Sun, the resulting time interval would be about four minutes longer than the period determined by the Earth's rotation. This is due to the Earth's yearly orbital motion around the Sun, which continuously changes the apparent position of the Sun against the background of stars, traditionally observed as the cyclical procession of the zodiac. Thus, during the course of a day, the Sun appears to lag a little to the east with respect to the stars, and the Earth's rotation must exceed a complete rotation (360°) in order to have the Sun appear overhead at the local meridian.

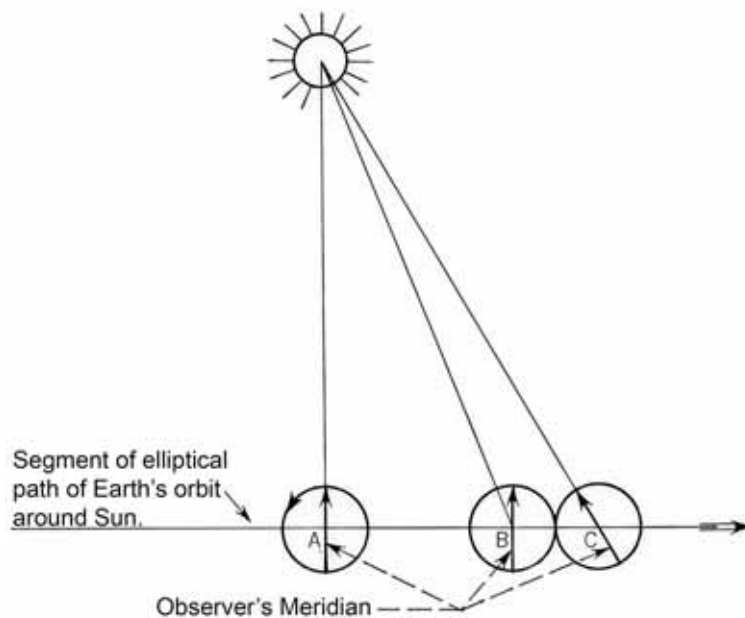

Figure 1600a. Apparent eastward movement of the Sun with respect to the stars.

Apparent eastward lag of the Sun with diurnal observations - when the Sun is on the observer's meridian at point A in the Earth's orbit around the Sun (see Figure 1600a), it will not be on the observer's meridian after the Earth has rotated once (360°) because the Earth will have moved along its orbit to point B. Before the Sun can again be observed on the observer's meridian, the Earth must turn a little more on its axis as shown in C. Thus, during the course of a day (as determined by the Earth's rotation period) the Sun appears to move eastward with respect to the celestial back-

ground of stars.

The apparent positions of individual stars against the celestial background are commonly determined with reference to an imaginary point called the **vernal equinox**. The vernal equinox is the intersection of the celestial equator and the ecliptic (see Figure 1600b). The full rotation of the Earth measured with respect to the vernal equinox is called a **sidereal day**, and corresponds to the Earth's rotational period. The period with respect to the Sun is called an **apparent solar day**, and includes the additional time to

compensate for the Earth's orbital motion.

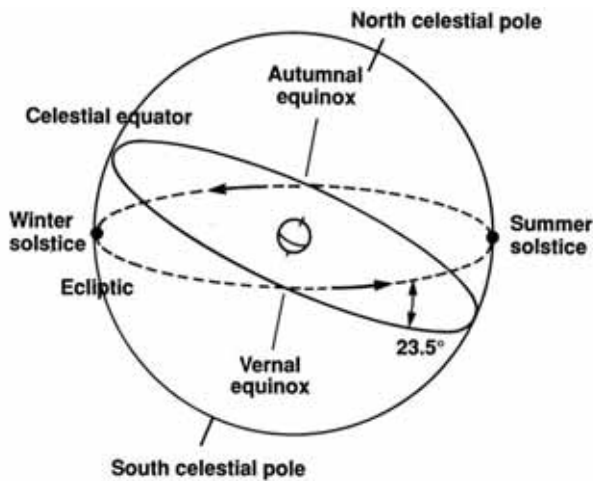

Figure 1600b. Solstices and equinoxes on the ecliptic.

A navigator using the observed position of the Sun, or the apparent Sun, to measure the passage of time from Earth's rotation results in **apparent solar time**. Apparent solar time is what a perfectly constructed and calibrated sundial would read at a given location, based on the apparent position of the Sun in the sky. In astronomical terms, apparent solar time is determined by the **local hour angle**, which is a measure of the Sun's projected angular distance east or west of the local **meridian**. Since each meridian is a line of constant longitude, at any instant of the Earth's rotation, the apparent solar time will differ for every longitude. We define apparent solar time at a specific location as 12^{h} + the local hour angle (expressed in hours) of the apparent position of the Sun in the sky. The local hour angle is negative when presenting east of the meridian.

Apparent solar time is not a uniform time scale; the apparent Sun crosses the sky at slightly different rates at different times of the year. This means the apparent solar time runs “fast” with respect to a constant timescale, such as a chronometer, part of the year and “slow” during other parts of the year. Although the daily fractional change in the rate of the Sun's apparent motion is small, the accumulated time difference can reach as much as sixteen minutes. This effect is a function of the Earth's orbit around the Sun. It is the result of two superimposed cycles; the Earth's eccentricity (no-circular orbit) and the tilt of Earth's axis with respect to the plane of its orbit (the ecliptic).

In order to create a uniform time scale for practical use, we imagine a point in the sky called the **fictitious mean sun**, which moves at a constant rate across the sky (at the celestial equator), regardless of the time of year. That is, the fictitious mean sun averages out the variations in the position and rate of motion of the true Sun over the course of an entire year. The fictitious mean sun is never more than about 4 degrees east or west of the actual Sun, although it is only an imaginary point. We can define **mean solar time** in

the same way as apparent solar time: mean solar time at a specific location is 12^{h} + the local hour angle (expressed in hours) of the fictitious mean sun. Of course, the fictitious mean sun is not an observable point, so we need a mathematical expression to tell us where it is with respect to the true Sun; this is the equation of time.

1601. Equation of Time

Mean solar time is sometimes ahead (fast) and sometimes behind (slow) of the apparent solar time. This difference is called the **equation of time**. The equation of time's minimum value is near -14 m 13 s in mid-February, and its maximum value is near 16 m 26 s in early November.

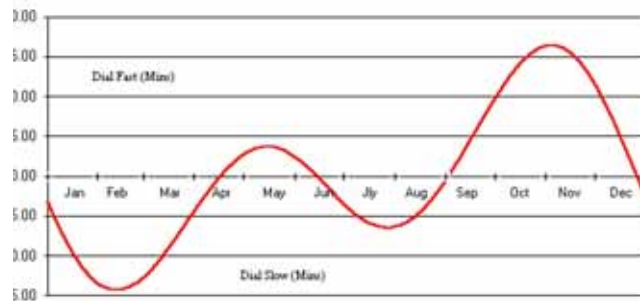

Figure 1601a. Equation of time.

The **equation of time** gives the offset in minutes applied to mean solar time, as may be determined by a chronometer, to calculate the apparent solar time; specifically at the Sun's apparent passage at the local meridian.

The navigator most often deals with the equation of time when determining the time of **upper meridian passage** of the Sun, called **Local Apparent Noon (LAN)**. Were it not for the difference in rate between the fictitious mean and apparent Sun, the Sun would always appear on the observer's meridian at 12^{h} (noon) local time. Except for four unique times of the year related to the interaction of the Earth's eccentric orbit and inclination to the ecliptic, the LAN will always be offset from exactly noon mean solar time. This time difference, which is applied as the equation of time at meridian transit, is listed on the right hand daily pages of the *Nautical Almanac*.

The sign of the equation of time is negative if apparent time is behind mean time; it is positive if apparent time is ahead of mean time. In either case, the equation is: $\text{Apparent Time} = \text{Mean Time} + (\text{equation of time})$. A negative equation of time is indicated by shading in the *Nautical Almanac*.

Example 1: Determine the local mean time of the Sun's meridian passage (Local Apparent Noon) on June 16, 2016.

Solution: See the *Nautical Almanac's* right hand daily page for June 16, 2016 (Figure 1601b). The equation of time is listed in the bottom right hand corner of the page.

There are two ways to solve the problem, depending on the accuracy required for the value of meridian passage. First, for minute accuracy, the time of the Sun at meridian passage is given to the nearest minute in the "Mer. Pass." column. For June 16, 2016, this time is 1201.

Second, to determine the nearest second of time of meridian passage, use the value given for the equation of time listed immediately to the left of the "Mer. Pass." column on the daily pages. For June 16, 2016, the value is given as negative 00 m 47 s. (Use the "12 h" column because the problem asked for meridian passage at LAN.)

Using the equation $Apparent\ Time = Mean\ Time + (equation\ of\ time)$, we have $1200 = Mean\ Time + (-0047)$. Rearranging, we get $Mean\ Time = 1200 + 0047$. The exact mean time of meridian passage for June 16, 2016, is 12 h 00 m 47 s.

To calculate latitude and longitude at LAN, the navigator seldom requires the time of meridian passage to accuracies greater than one minute (0.25 degrees of longitude). Therefore, use the time listed under the "Mer. Pass."

4.2	S	50	16 03	16 42	17 23	01 33	03 33	04 34	
4.2		52	15 54	16 34	17 18			04 39	
4.2		54	15 42	16 26	17 11			04 45	
4.2		56	15 30	16 17	17 07			04 52	
4.2		58	15 15	16 07	17 00			04 59	
4.2	S	60	14 58	15 55	16 46			05 07	
SUN									
4.3	Day	Eqn. of Time		Mer.	Mer. Pass.		Age	Phase	
4.3		00 ^h 12 ^h		Pass.	Upper	Lower	d	%	
4.3	d	m	s	m	s	h	m	h	m
4.3	14	00	16	00	22	12	00	19	49
	15	00	28	00	35	12	01	20	32
.8	16	00	41	00	47	12	01	21	16

Figure 1601b. Extract from the Nautical Almanac daily pages for June 16, 2016.

column to estimate LAN unless extraordinary accuracy is required.

1602. Fundamental Systems of Time

Atomic based timekeeping is determined by the definition of the Systeme International (SI) second, with duration of 9,192,631,770 cycles of electromagnetic radiation corresponding to the transition between two hyperfine levels of the ground state of cesium 133. **International Atomic Time (TAI)** is an international time scale based on the non-stationary ensemble of atomic clock observations contributed by worldwide timekeeping laboratories, qualified by the Bureau International des Poids et Mesures (BIPM).

Universal time (UT) is a generic reference to one of several timescales that approximate the mean diurnal motion of the fictitious mean sun. Loosely, UT is **mean solar time at zero longitude**, or the **Greenwich meridian** (previously known as **Greenwich Mean Time (GMT)**). The term GMT has been dropped from scientific usage. In cur-

rent usage, UT either refers to **UT1** or **Coordinated Universal Time (UTC)**. In the navigational publications, UT always means UT1.

UT1 is a continuous timescale precisely defined by a mathematical expression that relates it to sidereal time, or the angle and rate of Earth's rotation to fixed points (usually very distant objects) of reference on the celestial background. Thus, UT1 is observationally determined by the apparent diurnal motions of celestial bodies and is affected by irregularities and the slowing of Earth's rate of rotation.

Coordinated Universal Time (UTC) is a discontinuous timescale determined by TAI and maintained by the BIPM. UTC is recognized by nearly all worldwide timing centers as the standard reference clock for purposes ranging from navigation to precise time stamping of financial transactions. UTC is accurately distributed (usually better than ± 1 ms) by radiometric and optical fiber-based transmission. UTC defines the 24 hour cycle or clock as 86,400 SI seconds, not related to the rotation rate of the Earth. In this way, UTC appears to run faster than UT1, although it is UT1 that is varying because of the slowing of the Earth. To maintain the long term coordination of UTC with UT1 to within ±0.9 seconds, a one second interval is typically added as necessary to UTC. This added interval is known as a leap second. Since the explicit synchronization of UTC and UT1 in 1958 through 2016, there have been 36 leap seconds inserted into UTC. Although the expectation of the leap second insertion should be regular, it is not, and it is this irregularity that makes the implementation of the leap second undesirable to the highly synchronized worldwide systems based on UTC. The leap second insertion is what characterizes UTC as a discontinuous time scale. The formal insertion of leap second is to expand the minute modulo by one (count the minute with a leap second as 58,59,60,00). Because the difference between UT1 and UTC are always less than 0.9 sec, navigators often do not need to account for the difference except when the highest precisions are required.

GPS Time is the time disseminated by the Navstar satellites of GPS, and is not UTC(USNO), meaning UTC as maintained by the United States Naval Observatory (USNO). Rather GPS Time is a continuous timescale monitored against the USNO master clock and maintained with a fixed offset of 19 seconds added to TAI. To formulate UTC, a leap second field is given within the navigation message of the GPS signal, which the receiver then uses to accordingly increment GPS Time. The need for a continuous timescale for Global Navigation Satellite Systems (GNSS), such as GPS Time, is necessary to allow for the determination of velocity and interaction with inertial navigation systems. In this way, real time system dynamics may be separated from the discrete time of day feature of GPS. See Section 1613 on dissemination systems for further details.

Terrestrial time (TT), formerly known as Terrestrial Dynamical Time (TDT), is rarely used by a navigator. In practice $TT = TAI + 32.184\ sec$.

Sidereal time is the hour angle of the vernal equinox. If the mean equinox is used (that is, neglecting nutation), the result is mean sidereal time; if the true equinox is used, the result is apparent sidereal time. The hour angle can be measured with respect to the local meridian or the Greenwich meridian, yielding, respectively, local or Greenwich (mean or apparent) sidereal times.

Delta T is the difference between Terrestrial Time and Universal Time: $\Delta T = TT - UT1$.

1603. Time and Longitude Arc

A navigator may be required to convert the measure of longitude arc to time or vice versa. The concept and math is not difficult, and calculators or tables (such as the one provided on page i in the back of the *Nautical Almanac*) can help. To illustrate, note that in this section, one day represents one complete rotation of the Earth as determined by a mean solar day. That is, one 24-hour period of 86,400 seconds is the same as the Earth rotating 360° . Therefore, the time of day is an indication of the phase (amount of rotation) within the Earth's orbital period, calculating how much of a mean solar day has elapsed, or what part of a rotation has been completed. For example, initialing the day at zero hours, at one hour later, the Earth has turned through $1/24$ of its rotation, or $1/24$ of 360° , or $360^\circ \div 24 = 15^\circ$

Smaller intervals can also be stated in angular units; since 1 hour or 60 minutes is equivalent to 15° of arc, 1 minute of time is equivalent to $15^\circ \div 60 = 0.25^\circ = 15'$ of arc, and 1 second of time is equivalent to $15' \div 60 = 0.25' = 15''$ of arc. Therefore any time interval can be expressed as an equivalent amount of rotation, and vice versa. Conversion among these units can be aided by the relationships indicated below, summarizing in table form:

1 ^d	=24 ^h	=360 [°]
60 ^m	=1 ^h	=15 [°]
4 ^m	=1 [°]	=60'
60 ^s	=1 ^m	=15'
4 ^s	=1'	=60''
1 ^s	=15''	=0.25'

To convert time to arc:

If time is in hh:mm:ss format:

1. Convert to decimal hours. Take mm and divide by 60 (60 is the number of minutes per hour). Take ss and divide by 3600 (3600 is the number of seconds per hour). Add both to hh. Mathematically, decimal hours = $hh + mm \div 60 + ss \div 3600$.
2. Multiply decimal hours by 15 to obtain decimal degrees of arc.
3. If needed, convert decimal degrees of arc to $\text{deg}^\circ \text{amin}' \text{asec}''$ format, where deg is degree, amin is

minutes of arc, and asec is seconds of arc. To do this, deg is simply the integer portion of the decimal degrees. That is, the numbers before the decimal point. Take the remaining portion (that is, the decimal part) and multiply by 60. The minutes of arc, amin, is the integer portion of this. Take the remaining portion of this new value and again multiply it by 60. That is the seconds of arc, asec.

Example 1: Convert $14^h 21^m 39^s$ to arc.

Solution:

Step 1: Convert to decimal hours. $14 + 21 \div 60 + 39 \div 3600 = 14 + 0.35 + 0.01083 = 14.360833$ hours

Step 2: Multiply by 15. $14.360833 \times 15 = 215.4125^\circ$

Step 3: Convert to $\text{deg}^\circ \text{amin}' \text{asec}''$ format. The deg equal the integer portion of 215.4125, so deg = 215. The amin is found by taking the remainder, .4125, and multiplying it by 60; $.4125 \times 60 = 24.75$. The amin equals the integer part, so amin = 24. The asec is found by taking the remainder of that, .75, and multiplying it by 60, which equals 45, so asec = 45. The final answer is

$$14 \text{ h } 21 \text{ m } 39 \text{ s of time} = 215^\circ 24' 45''$$

To convert arc to time, the steps are similar.

If arc is in the $\text{deg}^\circ \text{amin}' \text{asec}''$ format:

Step 1: Convert to decimal degrees. To do this, take amin and divide by 60 (60 is the number of minutes of arc per degree). Take asec and divide by 3600 (3600 is the number of seconds of arc per degree). Add both to deg. Mathematically, decimal degrees = $\text{deg} + \text{amin} \div 60 + \text{asec} \div 3600$.

Step 2: Divide decimal degrees of arc by 15 to obtain decimal hours of time.

Step 3: If needed, convert decimal hours to hh:mm:ss format, where hh is hour, mm is minutes of time, and ss is seconds of time. To do this, hh is simply the integer portion of the decimal hours. That is, the numbers before the decimal point. Take the remaining portion (that is, the decimal part) and multiply by 60. The minutes of time, mm, is integer portion of this. Take the remaining portion of this new value and again multiply it by 60. That is the seconds of time, ss.

Convert $215^\circ 24' 45''$ to time units.

Step 1: Convert to decimal degrees. Decimal degrees = $\text{deg} + \text{amin} \div 60 + \text{asec} \div 3600$. In this example, $215 + (24 \div 60) + (45 \div 3600)$, which equals 215.4125 degrees.

Step 2: Divide decimal degrees of arc by 15 to obtain decimal hours of time. $215.4125 \div 15 = 14.360833$ hours.

Step 3: Convert decimal hours to hh:mm:ss format. The hh equal the integer portion of 14.360833, so hh = 14.

The mm is found by taking the remainder, .360833, and multiplying it by 60; $.360833 \times 60 = 21.65$. The mm equals the integer part, so mm = 21. The ss is found by taking the remainder of that, .65, and multiplying it by 60, which equals 39, so ss = 39. The final answer is

$$215^\circ 24' 45'' = 14 \text{ h } 21 \text{ m } 39 \text{ s}$$

Solutions can also be made using arc to time conversion tables in the almanacs. In the *Nautical Almanac*, the table given near the back of the volume is in two parts, permitting separate entries with degrees, minutes, and quarter minutes of arc. This table is arranged in this manner because the navigator converts arc to time more often than the reverse.

Convert $334^\circ 18' 22''$ to time units, using the *Nautical Almanac* arc to time conversion table.

Convert the 22" to the nearest quarter minute of arc for solution to the nearest second of time. Interpolate if more precise results are required.

$$334^\circ 00.00 \text{ m} = 22 \text{ h } 16 \text{ m } 00 \text{ s}$$

$$000^\circ 18.25 \text{ m} = 00 \text{ h } 01 \text{ m } 13 \text{ s}$$

$$334^\circ 18' 22'' = 22 \text{ h } 17 \text{ m } 13 \text{ s}$$

1604. Time Passage and Longitude

Section 1603 provides the direct coordination between the measure of longitude arc and the time passage of the mean solar day, equivalent to 24 hours equals 360 degrees of Earth's rotation. Thus, the measure of longitude between two fixed points is an angular equivalent of the time difference between these two points on the Earth. Therefore for any given time of day, places east of an observer have later time, and those places west have earlier time. The time difference observed between two places is equal to the difference of longitude between their meridians, expressed in units of time instead of arc. It is from this principle that longitude navigation through the use of a chronometer is derived. If an error free chronometer was set precisely at 12h at a given local noon, properly adjusted for the equation of time, then any longitudinal excursion (distance traveled east or west) could be determined through the interval of time passage on the chronometer, compared to the transit of the Sun across the new local (present) meridian.

1605. The Date Line

Since time accumulates later when traveling toward the east and earlier toward the west, a traveler circling the Earth gains or loses an entire day depending on the direction of travel. To provide a starting place for each new mean solar

day, a date line extending from Earth's poles is fixed by informal agreement, called the **International Date Line**. The International Date Line separates two consecutive calendar days. It coincides with the 180th meridian over most of its length. In crossing this line, the date is altered by one day. The date becomes one day earlier when traveling eastward from east longitude to west longitude. Conversely the date becomes one day later when traveling westward across it. When solving celestial problems, we convert local time to UTC and then convert this to local time on the opposite side of the date line.

1606. Civil Time vs. Mean Solar Time and Time Zones

Mean solar time is closely related to **civil time**, which is what our clocks read if they are set accurately. The worldwide system of civil time has historically been based on mean solar time, but in the modern system of timekeeping, there are some differences.

Civil time is based on a worldwide system of 1-hour time zone segments, which are spaced 15 degrees of longitude apart. (The time zone boundaries are usually irregular over land, and the system has broad variations; local time within a country is the prerogative of that country's government.) All places within a time zone, regardless of their longitudes, will have the same civil time, and when we travel over a time zone boundary, we encounter a 1-hour shift in civil time. The time zones are set up so that each is an integral number of hours from a time scale called Coordinated Universal Time (UTC). UTC is accurately distributed by GPS, the Internet, and radio time signals. So the minute and second "ticks" of civil time all over the world are synchronized and counted the same; it is only the hour count that is different. (There are a few odd time zones that are a $\frac{1}{4}$ or $\frac{1}{2}$ hour offset from neighboring zones. The minute count is obviously different in these places.)

1607. Zone Time

At sea, as well as ashore, watches and clocks are normally set to some form of **zone time (ZT)**. At sea the nearest meridian exactly divisible by 15° is usually designated as the **time meridian** or **zone meridian**. Thus, within a time zone extending $\pm 7.5^\circ$ on each side of the time meridian the time is the same, and time in consecutive zone increments differs by exactly one hour. The time maintained by a clock is changed as convenient, usually at a whole hour, when crossing the boundary between zones. Each time zone is identified by the number of times the longitude of its zone meridian is divisible by 15° , *positive in west longitude* and *negative in east longitude*. This number and its sign, called the **zone description (ZD)**, is the number of whole hours that are added to or subtracted from the zone time to obtain UTC. Note that the zone description does not change when Daylight Savings Time is in effect.

The mean fictitious sun is the celestial reference point for zone time. See Table 1607a and Figure 1607b for more detail.

Time Zones, Zone Descriptions, and Suffixes					
ZONE	ZD	SUFFIX	ZONE	ZD	SUFFIX
7.5° W to 7.5° E	0	Z	7.5° W to 22.5° W	+ 1	N
7.5° E to 22.5° E	-1	A	22.5° W to 37.5° W	+ 2	O
22.5° E to 37.5° E	-2	B	37.5° W to 52.5° W	+ 3	P
37.5° E to 52.5° E	-3	C	52.5° W to 67.5° W	+ 4	Q
52.5° E to 67.5° E	-4	D	67.5° W to 82.5° W	+ 5	R
67.5° E to 82.5° E	-5	E	82.5° W to 97.5° W	+ 6	S
82.5° E to 97.5° E	-6	F	97.5° W to 112.5° W	+ 7	T
97.5° E to 112.5° E	-7	G	112.5° W to 127.5° W	+ 8	U
112.5° E to 127.5° E	-8	H	127.5° W to 142.5° W	+ 9	V
127.5° E to 142.5° E	-9	I	142.5° W to 157.5° W	+ 10	W
142.5° E to 157.5° E	-10	K	157.5° W to 172.5° W	+ 11	X
157.5° E to 172.5° E	-11	L	172.5° W to 7.5° W	+ 12	Y
172.5° E to 180° E	-12	M			

Note. - GMT is indicated by suffix Z. Standard times as kept in various places or countries are listed in *The Nautical Almanac* and *The Air Almanac*.

Table 1607a. Time zones, descriptions, and suffixes.

When converting ZT to UTC, a positive ZT is added and a negative one subtracted; converting UTC to ZT, a positive ZD is subtracted, and a negative one added.

Example: The UTC is 15^h27^m09^s.

Required: (1) ZT at long. 156°24.4' W

Solutions: 15 h 27 m 09 s - (+150/15) = 05 h 27 m 09 s

In example (1), the nearest 15° increment is 150°W, leaving a remainder of less than ±7.5° (+6.407°).

Example: The UTC is 15^h27^m09^s.

Required: (2) ZT at long. 039°04.8' E

Solutions: 15 h 27 m 09 s + (-45/15) = 18 h 27m 09 s

In example (2), the nearest 15° increment is 45°E, leaving a remainder of less than ±7.5° (-5.92°).

1608. Chronometer Time

Chronometer time (C) is time indicated by a chronome-

ter. Since a chronometer is set approximately to UTC and not reset until it is overhauled and cleaned about every 3 years, there is nearly always a **chronometer error (CE)**, either fast (F) or slow (S). The change in chronometer error in 24 hours is called **chronometer rate**, or daily rate, and designated gaining or losing. With a consistent error in chronometer rate of +1s per day for three years, the chronometer error would accumulate 18 minutes. Since chronometer error is subject to change, it should be determined from time to time, preferably daily at sea. Chronometer error can be determined by comparison to a radio derived time signal, by comparison with another timekeeping system of known error, or by applying chronometer rate to previous readings of the same instrument. It is recorded to the nearest whole or half second. Chronometer rate is recorded to the nearest 0.1 second/day.

Example: At UTC 1200 on May 12 the chronometer reads 12^h04^m21^s. At UTC 1600 on May 18 it reads 4^h04^m25^s.

Required:

1. Chronometer error at 1200 UTC May 12.
2. Chronometer error at 1600 UTC May 18.
3. Chronometer rate.
4. Chronometer error at UTC 0530, May 27.

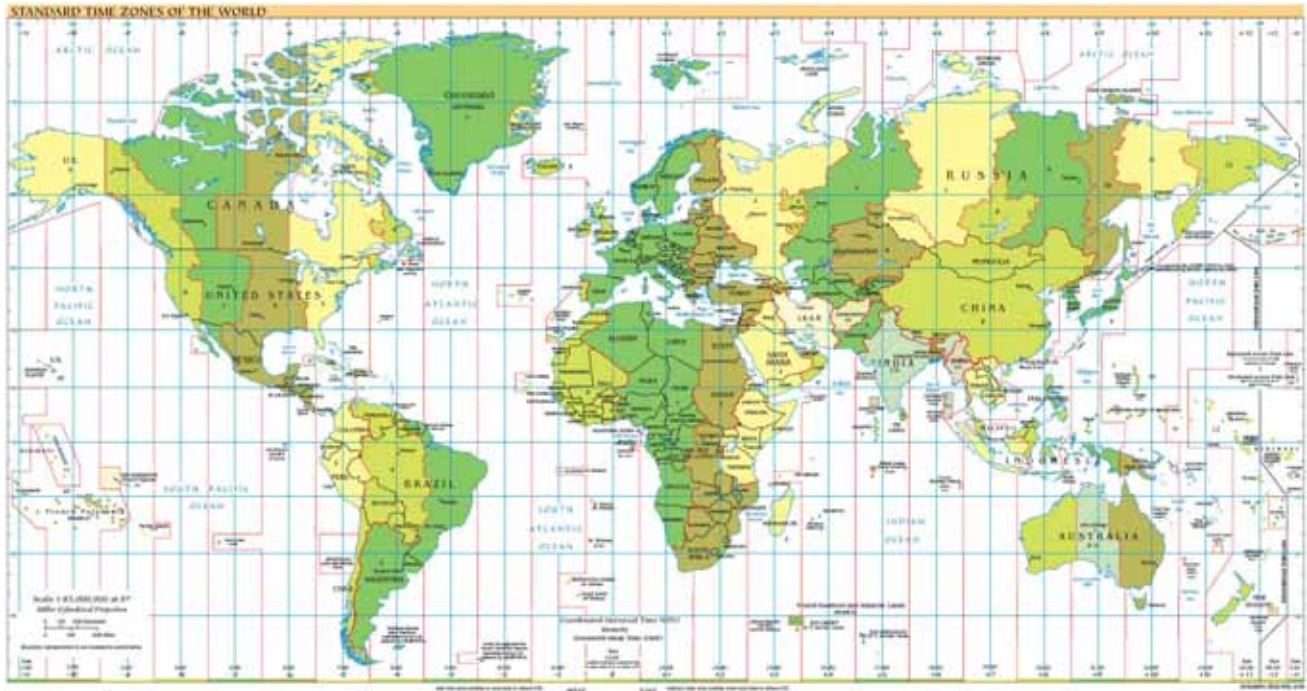

Figure 1607b. Time zones of the world.

Solutions:

- | | | | |
|----|------------|---|----------------------------------|
| 1. | UTC | 12 ^h 00 ^m 00 ^s | May 12 |
| | C | 12 ^h 04 ^m 21 ^s | |
| | CE | (F)4 ^m 21 ^s | gaining |
| 2. | UTC | 16 ^h 00 ^m 00 ^s | May 18 |
| | C | 04 04 25 | |
| | CE | (F)4 ^m 25 ^s | gaining |
| 3. | UTC | 18 ^d 16 ^h | present |
| | UTC | 12 ^d 12 ^h | past |
| | diff. | 06 ^d 04 ^h = 6.2 ^d | |
| | CE | (F)4 ^m 21 ^s | 1200 May 12 |
| | CE | (F)4 ^m 25 ^s | 1600 May 18 |
| | diff. | 4 ^s (gained) | |
| | daily rate | 0.6 ^s / ^d (gain) | 4 ^s /6.2 ^d |
| 4. | UTC | 27 ^d 05 ^h 30 ^m | present |
| | UTC | 18 ^d 16 ^h 00 ^m | past |
| | diff. | 08 ^d 13 ^h 30 ^m (8.5 ^d) | |
| | CE | (F)4 ^m 25 ^s | 1600 May 18 |
| | corr. | (+)0 ^m 05 ^s | diff. × rate |
| | CE | (F)4 ^m 30 ^s | 0530 May 27 |

Because UTC is on a 24-hour basis and chronometer time on a 12-hour basis, a 12-hour ambiguity exists. This is ignored in finding chronometer error. However, if chronometer error is applied to chronometer time to find UTC, a 12-hour error can result. This can be resolved by mentally applying the zone description to local time to obtain approximate UTC. A time diagram can be used for resolving doubt as to approximate UTC with date. If

the Sun for the kind of time used (mean or apparent) is between the lower branches of two time meridians (as the standard meridian for local time, and ZT 0 or Zulu meridian for UTC, the date at the place farther east is one day later than at the place farther west.

1609. Watch Time

Watch time (WT) is usually an approximation of zone time, except that for timing celestial observations it is easiest to set a comparing watch to UTC. If the watch has a second-setting hand, the watch can be set exactly to ZT or UTC, and the time is so designated. If the watch is not set exactly to one of these times, the difference is known as **watch error (WE)**, labeled fast (F) or slow (S) to indicate whether the watch is ahead of or behind the correct time.

If a watch is to be set exactly to ZT or UTC, set it to some whole minute slightly ahead of the correct time and stopped. When the set time arrives, start the watch and check it for accuracy.

The UTC may be in offset by 12^h, but if the watch is graduated to 12 hours, this will not be reflected. If a watch with a 24-hour dial is used, the actual UTC should be applied.

To determine WE, compare the reading of the watch with that of the chronometer at a selected moment. This may also be at some selected moment to UTC. Unless a watch is graduated to 24 hours, its time is designated as AM (ante meridian) before noon and PM (post meridian) after noon.

Even though a watch is set approximately to the zone

time, its error to UTC can be determined and used for timing observations. In this case the 12-hour ambiguity to UTC should be resolved, and a time diagram used to avoid miscalculation. This method requires additional work, and presents a greater probability of error, and gains no greater advantage provided through WE compensation.

If a stopwatch is used for timing observations, it should be started at some convenient UTC, such as a whole 5^m or 10^m. The time of each observation is then the UTC plus the watch time. Digital stopwatches and wristwatches are ideal for this purpose, as they can be set from a convenient UTC and read immediately after the observation is taken.

1610. Local Mean Time

Local mean time (LMT), like zone time, uses the mean Sun as the celestial reference point. It differs from zone time in that the local meridian is used as the terrestrial reference, rather than a zone meridian. Thus, the local mean time at each meridian differs from every other meridian, the difference being equal to the difference of longitude expressed in time units. At each zone meridian, including 0°, LMT and ZT are identical.

In navigation the principal use of LMT is in rising, setting, and twilight tables. The problem is usually one of converting the LMT taken from the table to ZT. At sea, the difference between the times is normally not more than 30^m, and the conversion is made directly, without finding GMT as an intermediate step. This is done by applying a correction equal to the difference of longitude. If the observer is west of the time meridian, the correction is added, and if east of it, the correction is subtracted. If Greenwich time is desired, it is found from ZT.

Where there is an irregular zone boundary, the longitude may differ by more than 7.5° (30^m) from the time meridian.

If LMT is to be corrected to daylight saving time, the difference in longitude between the local and time meridian can be used, or the ZT can first be found and then increased by one hour.

Conversion of ZT (including GMT) to LMT is the same as conversion in the opposite direction, except that the sign of difference of longitude is reversed. This problem is not normally encountered in navigation.

1611. Sidereal Time

Sidereal time uses the celestial datum of the vernal equinox (first point of Aries) as the celestial reference point instead of the apparent procession of Sun. Since the Earth revolves around the Sun, and since the direction of the Earth's rotation and revolution are the same, it completes a rotation with respect to the stars in less time (about 3 m 56.6 s of mean solar units) than with respect to the Sun, and during one revolution about the Sun (1 year) it makes one

complete rotation more with respect to the stars than with the Sun. This accounts for the daily shift of the stars nearly 1° westward each night. Hence, sidereal days are shorter than solar days, and its hours, minutes, and seconds are correspondingly shorter. Because of nutation, sidereal time is not quite constant in rate. Time based upon the average rate is called **mean sidereal time**, when it is to be distinguished from the slightly irregular sidereal time. The ratio of mean solar time units to mean sidereal time units is 1:1.00273791.

A navigator very seldom uses sidereal time.

1612. Time and Hour Angle

As mentioned earlier, **hour angle** is a measure of how far east or west of a meridian a celestial object appears. If the local meridian is used, this measure is called a **local hour angle (LHA)**. If the **Greenwich meridian** is used, then it is called a **Greenwich hour angle, GHA**. Hour angles are often expressed in arc units, between 0 and 360°. The hour angle is zero for an object crossing the meridian, and increases as the object moves west of the meridian (setting). In other words, an object transiting the meridian has an hour angle of 0°. Shortly after transit, its hour angle would be 1°, shortly before transit it would be 359°.

Sidereal time is the hour angle of the vernal equinox, but it is usually expressed in time units. Solar time at a specific location is also an hour angle measurement of the Sun, but since the day starts at midnight, 12 hours is added. That is, local solar time = 12 hours + local hour angle (expressed in hours) of the position of the Sun in the sky.

As with time, LHA at two places differs by their difference in longitude. In addition, it is often convenient to express hour angle in terms of the shorter arc between the local meridian and the body, that is, instead of 0° to 360°, it can be expressed 0° to 180°. This is similar to measurement of longitude from the Greenwich meridian. Local hour angle measured in this way is called meridian angle (*t*), which must be labeled east or west, like longitude, to indicate the direction of measurement. A westerly meridian angle is numerically equal to LHA, while an easterly meridian angle is equal to 360° - LHA. Mathematically, LHA = *t* (W), and LHA = 360° - *t* (E). Meridian angle is used in the solution of the navigational triangle.

Find LHA and t of the Sun at for long. 118°48.2' W if the GHA of the Sun is 231° 04.0'.

LHA = GHA - west longitude, and LHA = GHA + east longitude, thus, for our example

$$LHA(\text{Sun}) = 231^\circ 04.0' - 118^\circ 48.2' = 112^\circ 15.8'$$

$$t = 112^\circ 15.8' W$$

RADIO DISSEMINATION OF TIME SIGNALS

1613. Dissemination Systems

Of the many systems for time and frequency dissemination, the majority employ some type of radio transmission, either in dedicated time and frequency emissions or established systems such as radionavigation systems. The most accurate means of time and frequency dissemination today are by the mutual exchange of round-trip time signals through communication (commonly called Two-Way) and by the mutual observation of one-way signals from navigation satellites (such as Common View, All-in-View, and Differential GPS). One-way direct access to Global Navigation Satellite Systems (GNSS) is an excellent way to obtain UTC if many satellite observations are averaged.

Radio time signals can be used either to perform a clock's function or to set clocks. When using a radio wave several factors must be considered. One is the delay time of approximately 3 microseconds per kilometer it takes the radio wave to propagate and arrive at the reception point. Thus, a user 1,000 kilometers from a transmitter receives the time signal about 3 milliseconds later than the on-time transmitter signal. If time is needed to better than 3 milliseconds, a correction must be made for the time it takes the signal to pass through the receiver.

In most cases standard time and frequency emissions as received are more than adequate for ordinary needs. However, many systems exist for the more exacting scientific requirements, such as Precise Point Positioning using GNSS carrier phase.

1614. Characteristic Elements of Dissemination Systems

A number of common elements characterize most time and frequency dissemination systems. Among these elements, the most important are accuracy, ambiguity, repeatability or precision, coverage, availability of time signal, reliability, ease of use, cost to the user, and the number of users served. No single system optimizes all desired these characteristics. The relative importance of these characteristics will vary by application, and the solution for one user may not be satisfactory to another. These trade among these common elements are discussed in the following examination of a hypothetical radio signal.

Consider a very simple system consisting of an unmodulated 10-kHz signal as shown in Figure 1614. This signal, leaving the transmitter at 0000 UTC, will reach the receiver at a later time due to the propagation delay. The user must know this delay because the accuracy of the recovered time from the transmitted signal can be no better than the certainty in this delay. Since all cycles of the signal waveform are identical, the signal is ambiguous and

the user must resolve which cycle is the "on time" cycle, in this case the cycle leaving at 0000 UTC. This means, with respect to a 10-kHz signal waveform, the user must already know the propagation delay to within ± 50 microseconds (half the period of the signal). The calibration of the waveform cycle over cycle phase (zero crossings as defined in the figure) to resolve ambiguity in time dissemination is called the "tick to phase" determination. Further, the user may desire to periodically use the time-transfer system, say once a day, to check their clock or frequency standard. However, if the travel delay and instrument repeatability vary from one day to the next without the user knowing or correcting, the accuracy will be limited by the amounts attributed to these uncertainties.

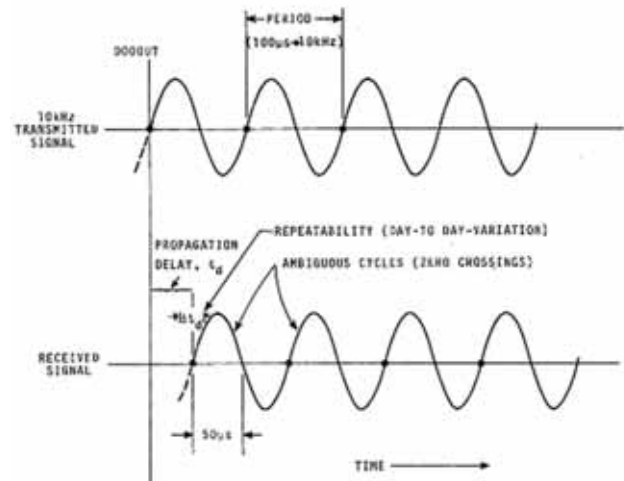

Figure 1614. Single tone time dissemination.

Many users are interested in making time-coordinated measurements over large geographic areas. They would like all measurements to be traceable to one master reference time to make corrections for the offsets between geographically distributed timekeeping systems. In addition, traceability to a master reference system increases confidence that all time measurements are related to each other in a consistent manner. Thus, the accuracy over the range of geographic coverage of a dissemination system is an important characteristic. Another important characteristic of a time dissemination system is the percentage of availability.

For most social uses of time, people who have to keep an appointment usually need to know the time of day to within a few minutes. Although requiring only coarse time information, people keeping a social schedule want it on demand, and thus carry a wristwatch or other portable device with a clock function that gives the time with continuous availability. People who have access to the internet can set the time of their personal computers to an

accuracy of UTC of ± 100 milliseconds, or considerably better, through the Network Time Protocol (NTP), with near continuous availability, dependent on the network's reliability. On the other hand, a person with a scientific interest may possess a very good clock capable of maintaining a few microseconds with only an occasional need for an accuracy update, perhaps only once or twice a day. However, in this distinguishing case, the scientific user requires much greater precision and accuracy in time dissemination than the social user, when available. This leads to the characteristic of time dissemination reliability, i.e., the likelihood that a time signal will be available when scheduled. In the case of the scientific user, the availability of time dissemination may be a critical operational need, and reliability may be as important as precision. Propagation fade-out or user location (such as in a basement or the woods) can sometimes prevent or distort signal reception. Thus, the quality and cost of time dissemination services contrast accuracy, availability and reliability against the application needs of the user community and the capability of their local clocks.

1615. Radio Wave Propagation Factors

Radio has been used to transmit standard time and frequency signals since the early 1900's. As opposed to the physical transfer of time via portable clocks, the transfer of timing information by radio involves the use of electromagnetic propagation from a transmitter, usually carrying the master reference time, to a navigator's receiver at long distance.

In the broadcast of frequency and time over radio, the transmitted signals are directly related to some master clock and are usually received with some degradation in accuracy. In a vacuum and with a noise-free background, timing signals should be received at a distant receiver essentially undistorted, with a constant path delay due to the propagation of the radio wave at the speed of light (299,773 kilometers per second). However the propagation media, including the Earth's atmosphere and ionosphere, reflections and refractions caused by man-made obstructions and geographic features, and space weather (solar-activity), as well as the inherent characteristics of transmitters and receivers, degrade the fidelity and accuracy of timing derived from the received radio signals. The amount of degradation in timing recovered from the signals is also dependent upon the frequency of the transmitted radio wave (carrier frequency), and the length of signal path. In many cases the application of propagation models or supplementary information must be used to correct for the distorting effects. For example, GPS receivers, which only use the L1 frequency, have correction models built into their systems to correct for propagation through the ionosphere from space

Radio dissemination systems can be classified in a number of different ways. One way is to separate those carrier frequencies low enough to be reflected by the

ionosphere (below 30 MHz) from those sufficiently high to penetrate the ionosphere (above 30 MHz). The former can be observed at great distances from the transmitter but suffer from ionospheric propagation distortion that limits accuracy; the latter are restricted to line-of-sight applications but show less signal degradation caused by propagation effects. The most accurate systems tend to be those which use the higher, line-of-sight frequencies, and with the advent of space-based satellite navigation, such as GPS, these also have promoted the most users and applications for radio time dissemination.

1616. Standard Time Broadcasts

The World Radiocommunication Conference (WRC), is the means by which the International Telecommunications Union (ITU), allocates certain frequencies in five bands for standard frequency and time signal emission. For such dedicated standard frequency transmissions, the ITU Radiocommunication Sector (ITU-R) recommends that carrier frequencies be maintained so that the average daily fractional frequency deviations from the internationally designated standard for measurement of time interval should not exceed \pm ten parts per trillion.

1617. Time Signals

The modern method of determining chronometer error and daily rate is by comparison to time recovered from radionavigation signals. The most accurate and readily available method for vessels is from navigation receivers of GPS, or other GNSS, and/or, where available, Enhanced Long Range Navigation (eLORAN) signals. Also, many maritime nations broadcast time signals on short-wave frequencies, such as the U.S. station (WWV), or German station (DCF77). Further discussion can be found in *NGA Pub. 117, Radio Navigational Aids* and the British Admiralty *List of Radio Signals*. A list of signals transmitted by timing labs is published in the Annual Report of the International Bureau of Weights and Measures (BIPM). The BIPM report is currently available on the Internet (see Figure 1617a). An important reason for employing more than one technique is to guard against both malfunction in equipment or malicious interference, such as spoofing.



Figure 1617a. BIPM Annual Report on Time Activities.
<http://www.bipm.org/bipm/tai/annual-report.html>

If a vessel employs a mechanically actuated (main-spring) chronometer or even an atomic clock, the time

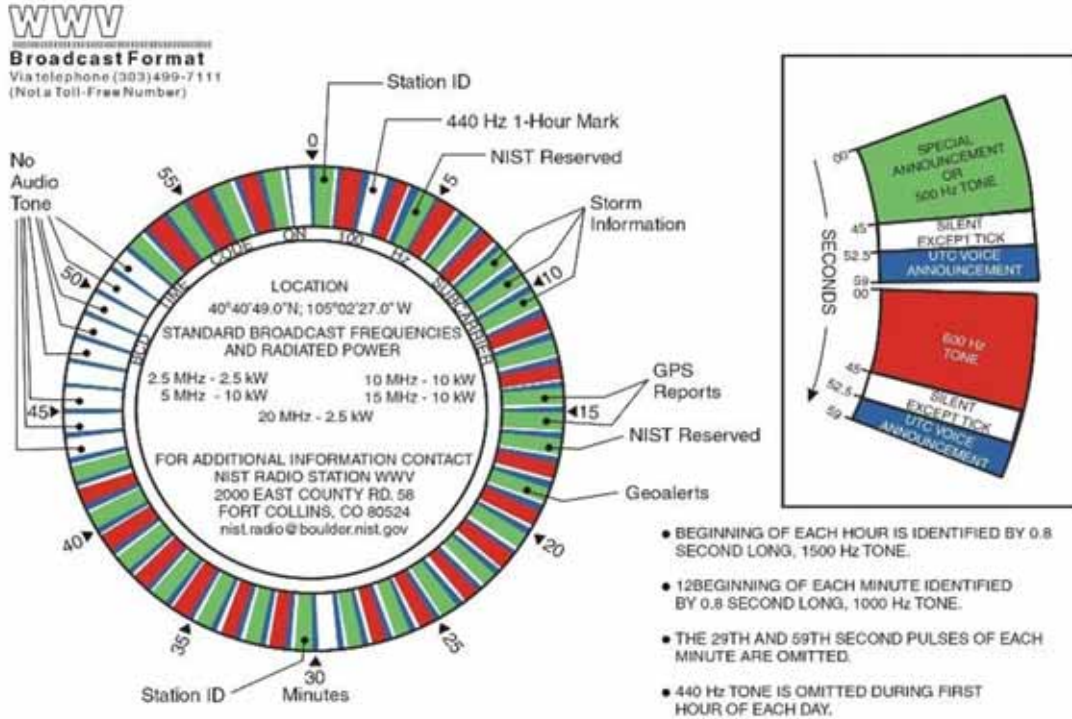

Figure 1617b. Broadcast format of station WWV.

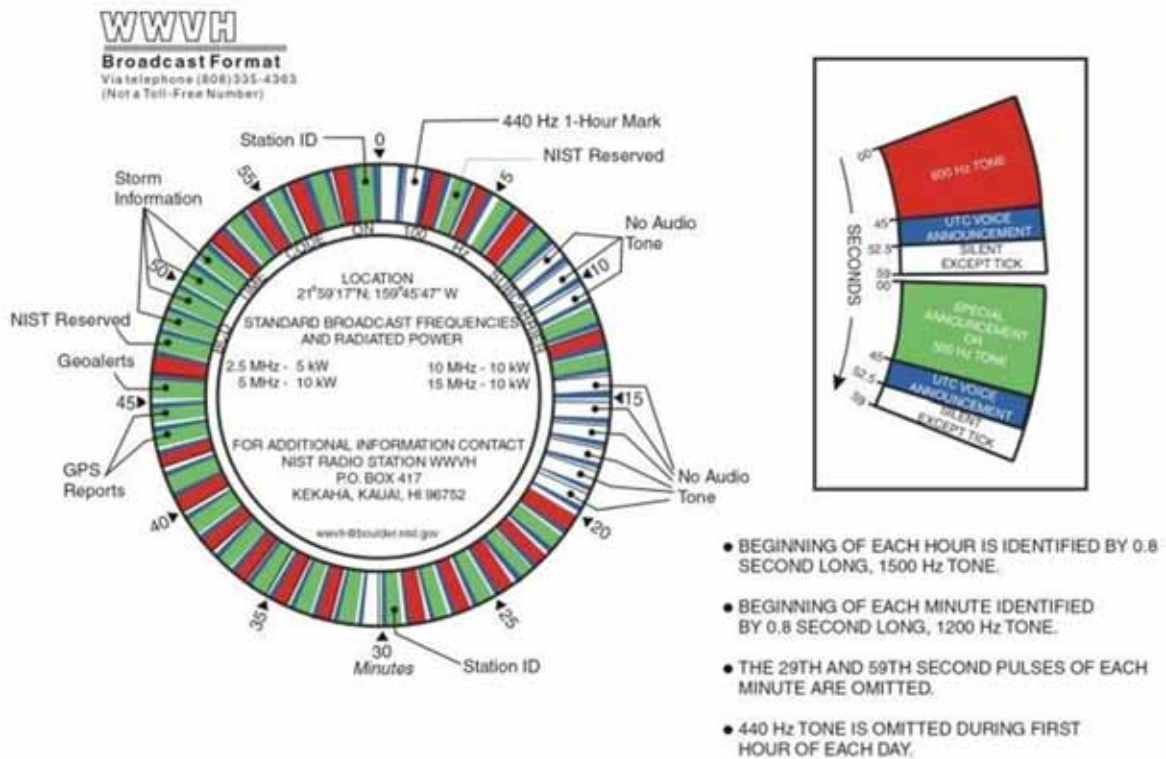

Figure 1617c. Broadcast format of station WWVH.

should nonetheless be checked daily against a time derived from radio signals, beginning at least three days prior to departure. The offset and computed rate should be entered in the chronometer record book (or record sheet) each time they are determined, although for an atomic clock the main concern is catastrophic or end of life failure. For example, cesium-beam tube atomic clocks have a limited life due to the consumption of the cesium metal during extended operation, typically 5 to 7 years.

For the U.S. the National Institute of Standards and Technology (NIST) broadcasts continuous time and frequency reference signals from WWV, WWVH, and WWVB. Because of their wide coverage and relative simplicity, the HF services from WWV and WWVH are used extensively for navigation. Station WWV broadcasts from Fort Collins, Colorado at the internationally allocated frequencies of 2.5, 5.0, 10.0, 15.0, and 20.0 MHz; station WWVH transmits from Kauai, Hawaii on the same frequencies with the exception of 20.0 MHz. The broadcast signals include standard time and frequencies, and various voice announcements. Details of these broadcasts are given in NIST Special Publication 432, NIST Frequency and Time Dissemination Services. Both HF emissions are derived from cesium beam atomic frequency standards with traceable reference to the NIST atomic frequency and time standards.

The time ticks in the WWV and WWVH emissions are shown in Figure 1617b and Figure 1617c. The 1-second UTC markers are transmitted continuously by WWV and WWVH, except for omission of the 29th and 59th marker each minute. With the exception of the beginning tone at each minute (800 milliseconds) all 1-second markers are of 5 milliseconds duration and at a tone of 440 Hz. Each pulse is preceded by 10 milliseconds of silence and followed by 25 milliseconds of silence. Time voice announcements are given also at one minute intervals. All time announcements are UTC.

As explained in the next section, Coordinated Universal Time (UTC) may differ from (UT1) by as much as 0.9 second; the actual difference can be found at IERS web pages Bulletin A, which published on the internet at

<http://datacenter.iers.org/eop/-/somos/5Rgv/latest/6>. NGA Pub. No. 117, *Radio Navigational Aids*, should be referred to for further information on time signals.

1618. Leap-Second Adjustments

By international agreement, UTC is maintained to be no more than ± 0.9 seconds from agreement with the continuous celestial timescale, UT1. The introduction of leap seconds allows a clock maintaining UTC to stay approximately coordinated with mean solar time or stay near the procession of the fictitious mean sun across the sky. The insertion of leap seconds makes UTC a discontinuous timescale. The main contributor to the need for a leap second adjustment is the slowing of the Earth's rotation at about 1.7 ms/century. However, because of irregular variations in the yearly rate of the rotation of the Earth, year over year occurrences of the insertion of a leap seconds is not predictable.

The Central Bureau of the International Earth Rotation and Reference Frames Service (IERS) decides upon and announces the introduction of a leap second. The IERS announces the leap second insertion at least eight weeks in advance. Because of the irregularity of the Earth's rotation, the IERS provides that a second may be advanced or retarded, positive or negative leap second, though a negative leap second has never been required since its institution in 1972. The leap second is introduced as the last second of a UTC month, but first preference is given to the end of December and June, and second preference is given to the end of March and September. A positive leap second begins at 23 h 59 m 60 s and ends at 00 h 00 m 00 s of the first day of the following month. In the case of a negative leap second, 23 h 59 m 58 s is followed one second later by 00 h 00 m 00 s (skipping 23 h 59 m 59 s) of the first day of the following month. Leap second adjustments of UTC are performed uniformly, and in synchrony (per interval of a SI second) across the world.

The dating of events in the vicinity of a leap second is effected in the manner indicated in Figure 1618a and Figure 1618b.

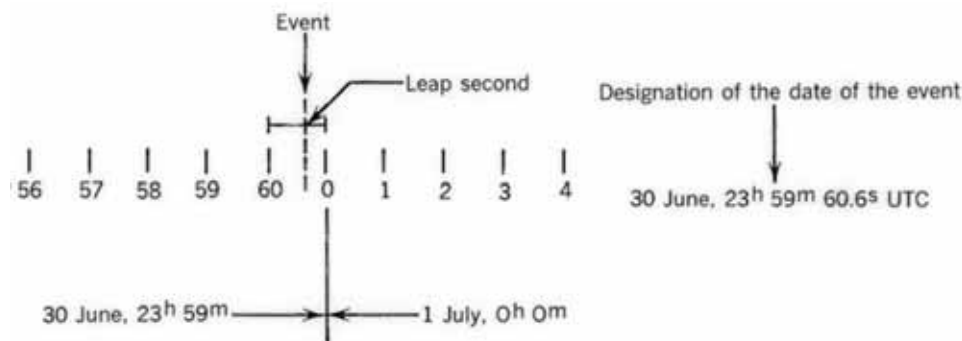

Figure 1618a. Dating of event in the vicinity of a positive leap second.

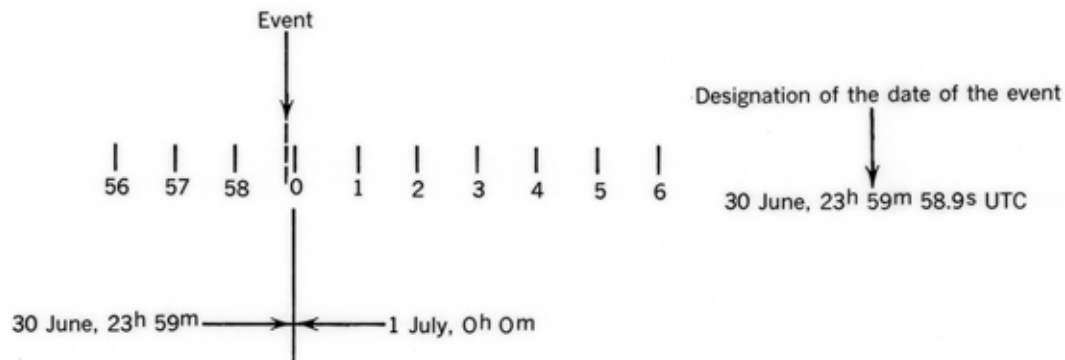

Figure 1618b. Dating of event in the vicinity of a negative leap second.

Whenever a leap second adjustment is to be made to UTC, navigators are advised by information presented on the web pages of the United States Naval Observatory, USNO, IERS Bulletin C and the International Bureau of Weights and Measures (BIPM). Additional information is available on the USNO and IERS webpages (see Figure 1618c and Figure 1618d).



Figure 1618c. USNO leap second data between January 1972 and January 2017. Link:
<http://maia.usno.mil/ser7/leapsec.dat>



Figure 1618d. IERS leap second announcement bulletins.
<https://www.iers.org/SharedDocs/News/EN/BulletinC.html>

1619. Use of Time, Time-interval, and other Novel Techniques for Approximate Determination of Chronometer Time, Latitude, and Longitude.

There may arise situations in which a mariner needs to address the problem of determining date, time, latitude, and longitude using only minimal resources and with little, if any, prior knowledge of the values of these parameters. Given this, it is useful to consider the value of using simple time, “time-interval”, azimuth, “azimuth interval”, and “instrument-free” or “instrument-limited” measurements,

performed in conjunction with table look-up of data from the Air or Nautical Almanacs and/or back-of-the-envelope computations. The term “instrument-limited”, in this context, applies when azimuth readings are made with a simple compass, and elevation readings are accomplished using a handheld inclinometer rather than a sextant or tripod-mounted surveying transit.

Figure 1619 illustrates a convenient instrument, which is a combined inclinometer/compass that can be used on land without a clearly defined horizon, and at night using internal illumination. One of the user’s eyes reads the internal scales while the other eye lines the internal graticule up with the star or other object being measured. The human ability to merge the different optical images into one perceived image is not universal. Up to 15% of individuals are unable to merge the different visual images. Although not of sextant accuracy, the device is rugged and portable, and is precise to about 1 degree for handheld use without a tripod.

Note that a modern smart phone, with its built in clock, camera, inclinometer, and compass can be used for the same purpose if GPS is denied, and can also be programmed with a star atlas, almanac data, and navigation algorithms. However, the successful use of a smartphone as a combined sextant, chronometer, and navigation computer depends critically on battery life.

The level of precision of an inclinometer and compass can be compared with the celestial measurements described previously as follows. Sextant measurements typically have a best-case precision of 0.2 minutes of arc. Related time measurements are typically accomplished with a resolution of one second. Note that 1 minute of arc at the equator corresponds to a distance of one nautical mile and equates to four seconds of clock time. Thus, it takes 4 seconds for the earth to rotate one arc-second around its axis.

With respect to precision measurement of time, knowledge of Greenwich or Universal time is typically specified to less than quartz clock accuracy (i.e., to about one second resolution). When there is a clock offset bias, its value and drift rate are typically known. It will often be the case that



Figure 1619. Combined compass/inclinometer with internal lighting and automatic leveling.

local time is synchronized to Greenwich time within one second, even for everyday consumer applications, and far better than this for time signals disseminated from a wireless network to one's cell phone.

Note that the poor relative precision of a magnetic compass with respect to that of a sextant precludes the combined use of sextant and azimuth measurements. However, when an inclinometer of limited precision is the best available instrument, it can also be beneficial to include compass-derived azimuth measurements of comparable precision.

With this background, some useful examples of relatively simple, but in certain situations of great value, navigation techniques are presented.

1. **Quick observation of Polaris and the northern sky to approximate latitude and longitude.** To estimate latitude simply make an observation (when in the northern hemisphere) of Polaris, the north star. If Greenwich or universal time is available using a simple quartz watch or cell phone, longitude can be inferred. This can be done with the help of a star chart, by observing the “clock angles” of the constellation Cassiopeia and Canis Major (the big dipper). Experienced viewers of the night sky routinely estimate time by unassisted observations of the moon and of the constellations of the Zodiac.
2. **Noon observation of the sun to compare with an observation of Polaris to determine solar declination, and hence to determine approximate date and time.** During daylight

hours, the maximum angle of the sun above the horizon at *local apparent noon* can be determined by a series of measurements made at time intervals of a few minutes. The highest elevation angle of the sun, $Elevation_{sun}$, occurs at local noon when the sun is due south of the observer. This measurement, combined with the estimate of latitude from measurement of the north star, Polaris, yields the declination of the sun. Specifically, the latitude value obtained from measurement of Polaris is related to the solar declination by the equation:

$$90 \text{ degrees} - Elevation_{sun} + declination = Latitude$$

The declination depends on time, but not on the observer's position. An approximate measurement of the declination can be matched to the daily tables in the Nautical Almanac to yield the date, and within a few hours, a value for Universal Time (which in this context can be regarded as being equivalent to Greenwich Mean Time, or GMT). For example, the elevation of the sun on September 30, 2016 measured at 1700 hours GMT is computed, from the Nautical Almanac, to be 47:50:30 deg:min:sec with an azimuth of 180.8 degrees, indicating that the measurement is made at a time that is very close to local apparent noon. Using the equation above, we deduce that the declination is $latitude + elevation - 90 = 39:00:00 + 47:50:30 - 90:00:00 = -3:09:30$, in very close agreement with the Nautical Almanac lookup value of -3:09:18 deg:min:sec.

Using this value of declination to identify a table entry in the Nautical Almanac takes one immediately to the daily entry for September 30, 2016 at 1700 hours universal time (e.g., GMT), thus illustrating the causal relationship between solar declination and date and time. Once GMT is known, the traditional methods of determining latitude and longitude using the stars, planets, and/or sun can be implemented.

Of course, if one knows Greenwich time to high precision from, for example, a digital watch, this same measurement, in conjunction with another measurement of the sun at a different point in time, yields the traditional *running fix*, which lies in the purview of the earlier sections of this chapter.

3. **Observations of sunrise and sunset to determine longitude.** If Greenwich time is known from a digital watch and an intelligent estimate of the relevant time zone, a simpler implementation of the running fix is easily accomplished. In this case, one measures only the times of sunrise and sunset, neither of which requires a sextant or artificial horizon when a clear horizon is available (i.e., on or near the ocean or other large body of water). The value for local noon is given as the midpoint in local time

of the sunrise and sunset measurements. When this value is corrected to Greenwich time by the appropriate time zone corrections, the longitude is estimated by multiplying the time of local noon by 15 degrees per hour.

A better estimate of longitude is then obtained by adding/subtracting the requisite correction for the *equation of time*. This is found on the daily page of the *Nautical Almanac* for the date and time of the observation, and is added/subtracted to the value of time that is then multiplied by the factor of 15 degrees per hour.

For example, the Washington Post newspaper provides daily values for local sunrise and sunset. On September 30, 2016, these are given as 7:03 A.M. and 6:52 P.M. EDT. Subtracting 1 hour to change to standard time, then taking the midpoint time yields a value for local noon of 11:57:30 h:m:s. Adding 10 minutes as the approximate correction for the equation of time (taken from the *Nautical Almanac* daily page for September 30th) corrects the time of local noon to GMT/UT, resulting in a value of 12:07:30 h:m:s.

If Washington was precisely 5 times zones away from Greenwich, then local noon in Washington would occur at 12:00:00 local time, after correcting for the equation of time. Five time zones, at 15 degrees per hour, is 75 degrees of longitude. Adding the additional 7.5 minutes corresponds to an additional 1.9 degrees of longitude, yielding a putative value for the longitude of Washington D.C. of 77 degrees West. (Note that the Naval Observatory, USNO, is at 38.9217° N, 77.0669° W).

4. **Compass measurement of the azimuth to Polaris to determine latitude and magnetic variation in order to determine position when latitude is already known.** Measurements made using a simple compass can be surprisingly useful. Measurement of the bearing of Polaris can be used to determine the local value of magnetic variation. Combined with an observation of latitude using an inclinometer or sextant, a map of magnetic variation versus latitude can then be used to generate an approximate position measurement.

In cases where magnetic variation is not known, relative bearing measurements yield “azimuth interval” measurements which remove the common mode error due to magnetic variation. In any case, the approach described herein is used routinely for pointing certain types of portable satellite telephone terminals at the appropriate satellite location in the geostationary arc.

5. **“Guess and Test” using simple Nautical Almanac equations in order to take advantage of combined elevation and azimuth measurements.**

Nautical Almanac computations can be quite complicated. For the purposes of this section, a convenient path forward is to use the straightforward equations for computing the calculated values of elevation angle H_c and azimuth Z from assumed values of the time, Greenwich Hour Angle (GHA), Sidereal Hour Angle (SHA), and declination for the celestial objects of interest. The relevant equations are given in the *Nautical Almanac* and are readily implemented using a calculator or perhaps a smartphone “App”.

Rather than use traditional iterative computations, this approach requires one to *guess* an “assumed position” and *test* the computed values of elevation H_c and azimuth Z against their measured values. One utility is that this provides a convenient way to integrate compass measurements of azimuth, corrected for magnetic variation as described above, into the data stream. The benefit is that a single sighting of the sun, if an azimuth measurement is included, provides the two data points needed to compute a latitude and longitude fix. There simply may not be time, or suitable weather conditions, to compute a running fix. The running fix, as described above, requires multiple measurements of the sun at widely spaced intervals of time.

6. **Cloudy night celestial navigation.** On a cloudy night, when only a single star is visible through a break in the clouds, a single measurement of the elevation and azimuth to a star lets one compute a location fix. Even if the identity of the star is not known, it is possible to perform the H_c and Z computations, for the assumed position, for several stars. Then the star whose measurement yields the most plausible position fix can often be reliably be assumed to be the star that was actually observed. Note that even a poor measurement of azimuth can be used to help identify the name, and hence the correct declination and sidereal hour angle values, to be used in the position computation.

There are many variations and extensions of these techniques and methods. The combination of a precision time reference and an accurate sextant is regaining favor after decades of single-system dependence on GPS, and more recently, E-LO-RAN. In extremis, and with little practice, even a combination of a protractor with a home-made plumb bob and a simple pendulum of length L and period $2\pi\sqrt{L/g}$ might bring one safely home.

CHAPTER 17

THE ALMANACS

PURPOSE OF ALMANACS

1700. Introduction

Celestial navigation requires accurate predictions of the geographic positions of the celestial bodies observed. These predictions are available from three almanacs published annually by the U.S. Naval Observatory and H.M. Nautical Almanac Office (part of the U.K. Hydrographic Office) in England.

The *Astronomical Almanac* precisely tabulates celestial data for the exacting requirements found in scientific fields. Its precision is far greater than that required by celestial navigation. Even if the *Astronomical Almanac* is used for celestial navigation, it will not necessarily result in more accurate fixes due to the limitations of other aspects of the celestial navigation process. This printed book is available in the U.S. through the Government Publishing Office eBookstore and resellers, and elsewhere via U.K. Hydrographic Office distributors. There is also an *Astronomical Almanac Online* complementary website.

The *Nautical Almanac* contains astronomical information specifically needed by marine navigators. Information is tabulated to the nearest 0.1' of arc and, with interpolation, to 1 second of time. GHA and declination are available for the Sun, Moon, planets (Venus, Mars, Jupiter and Saturn), and 173 stars, as well as corrections necessary to reduce the observed values to true. Also included are Sun rise/set, equation of time, Moonrise/set, moon phase, twilight times, time zones, and star charts. Explanations, examples, and sight reduction procedures are also given. This printed book is available in the U.S. through the Government Publishing Office eBookstore and resellers, and elsewhere via U.K. Hydrographic Office distributors.

The *Air Almanac* was originally intended for air navigators, but is used today mostly by the maritime community. In general, the information is similar to the *Nautical Almanac*, but is given to a precision of 1' of arc and 1 second of time, at intervals of 10 minutes (values for the Sun and Aries are given to a precision of 0.1'). Unique to the *Air Almanac* are its monthly sky diagrams, used to find navigational stars, planets, Sun and Moon at various

latitudes. This publication is suitable for ordinary navigation at sea, but lacks the precision of the *Nautical Almanac*, and provides GHA and declination for only the 57 commonly used navigation stars. The *Air Almanac* is available on CD or as a free download through the Government Publishing Office eBookstore. The CD and download contain the same information as was found previously in the annual publications, with page images in PDF files.

The US Naval Observatory also provides celestial navigation data via the web at <http://aa.usno.navy.mil/data/>.



Figure 1700. USNO Data Services.

This robust website includes a navigational star chart and other data services, which provide GHA, declination, computed altitude, azimuth and altitude correction information for the navigational objects above the horizon at a given assumed position and time. Additional data services found on this website includes Rise/Set/Transit/Twilight data, Phases of the Moon, Eclipses and Transits, Positions of Selected Celestial Bodies, Synthetic Views of Selected Solar System Bodies and Dates & Times.

The Navy's **STELLA** program (**S**ystem **T**o **E**stimate **L**atitude and **L**ongitude **A**stronomically), found aboard all seagoing Navy and Coast Guard vessels, contains an interactive almanac as well; this product is restricted to DoD and DoD contractors. A variety of privately produced electronic almanacs are available as computer programs or applications (apps). These invariably are associated with sight reduction software which replaces tabular and mathematical sight reduction methods.

FORMAT OF THE NAUTICAL AND AIR ALMANACS

1701. *Nautical Almanac*

The major portion of the *Nautical Almanac* (pages 10

to 253) is devoted to hourly tabulations of Greenwich Hour Angle (GHA) and declination, to the nearest 0.1' of arc. On each set of facing pages, information is listed for

three consecutive days. On the left-hand page, successive columns list GHA of Aries (Υ), and both GHA and declination of Venus, Mars, Jupiter, and Saturn, followed by the Sidereal Hour Angle (SHA) and declination of 57 stars. The GHA and declination of the Sun and Moon, and the horizontal parallax of the Moon, are listed on the right-hand page. Where applicable, the quantities v and d are given to assist in interpolation. The quantity v is the difference between the actual change of GHA in 1 hour and a constant value used in the interpolation tables, while d is the change in declination in 1 hour. Both v and d are listed to the nearest 0.1'.

On the left hand pages, the magnitude of each planet at Universal Time (UT) 1200 of the middle day of the three listed on a given page is found at the top of the column. The UT of transit across the Greenwich meridian is listed as "Mer. Pass.". The value for the first point of Aries for the middle of the three days is listed to the nearest 0.1' at the bottom of the Aries column. The time of transit of the planets for the middle day is given to the nearest whole minute, with SHA (at UT 0000 of the middle day) to the nearest 0.1', below the list of stars.

On the right hand pages, to the right of the Moon data is listed the Local Mean Time (LMT) of sunrise, sunset, and beginning and ending of nautical and civil twilight for latitudes from 72°N to 60°S. These times, which are given to the nearest minute, are UT of the phenomena on the Greenwich meridian. They are given for every day for moonrise and moonset, but only for the middle day of the three on each page for solar phenomena. For the Sun and Moon, the time of transit to the nearest whole minute is given for each day. For the Moon, both upper and lower transits are given. Also listed, are the equation of time for 0^h and 12^h UT, without sign, to the nearest whole second, with negative values shaded. The age and phase of the Moon is listed; age is given to the nearest whole day and phase is given by symbol. The semidiameters of both the Sun and Moon are also listed.

The main tabulation is preceded by a list of religious and civil holidays, phases of the Moon, a calendar, information on eclipses occurring during the year, and notes and a diagram giving information on the planets.

The main tabulation is followed by explanations and examples (pages 254 to 261). Next are four pages of standard times (zone descriptions). Star charts are next (pages 266-267), followed by a list of 173 stars in order of increasing SHA. This list includes the 57 stars given on the daily pages, identified by a number in the "Name and Number" field. It gives the SHA and declination each month, and the magnitude.

Stars are listed by Bayer's name, a designation that originated from Johann Bayer, a German uranographer (celestial cartographer), who in 1603 published an atlas that named the entire celestial sphere. The Bayer's name is used to identify these stars and also the popular name is listed where applicable. The brightest stars have been given a

designation consisting of a Greek letter followed by the possessive form of the name of the constellation to which they belong.

Following the star list are the Polaris tables (pages 274-276). These tables give the azimuth and the corrections to be applied to the observed Polaris altitude to find one's latitude.

Following the Polaris table is the "Sight Reduction Procedures" section, divided into two subsections. The first, "Methods and Formula for Direct Computation" (pages 277 to 283) gives formulas and examples for the entry of almanac data, the calculations that reduce a sight, and a method of solution for position, all for use with a calculator or computer. The second, "Use of Concise Sight Reduction Tables" (pages 284 to 319), gives instructions and examples of how to use the provided concise sight reduction tables and a sight reduction form. Tabular precision of the concise tables is one minute of arc.

The next pages (pp. 320-325) contain data on polar phenomena. Examples and graphs are given to estimate times of sunrise, sunset, civil twilight, moonrise, and moonset at extreme northern latitudes for each month of the year.

Next is a table for converting arc to time units (page i). This is followed by a 30-page table (pages ii - xxxi) called "Increments and Corrections," used for interpolation of the hourly GHA and declination to get to the nearest second of the sextant observation. This table is printed on tinted paper for quick location. Then come tables for interpolating for times of rise, set, and twilight (page xxxii); followed by two indices of the 57 stars listed on the daily pages, one index in alphabetical order, and the other in order of decreasing SHA (page xxxiii).

Altitude corrections are given at the front and back of the almanac. Tables for the Sun, stars, and planets, and a dip table, are given on the inside front cover and facing page, with an additional correction for nonstandard temperature and atmospheric pressure on the following page. Tables for the Moon, and an abbreviated dip table, are given on the inside back cover and facing page. Corrections for the Sun, stars, and planets for altitudes greater than 10°, and the dip table, are repeated on one side of a loose bookmark. The star indices are repeated on the other side.

1702. *Air Almanac*

The Air Almanac used to be a printed publication, but this was discontinued after the 2007 edition. Since then it has been available as a CD-ROM, and recently as a free download from the US Naval Observatory website: <http://aa.usno.navy.mil/publications> and the Government Publishing Office website. The electronic version contains the same information as was previously found in the printed version, but with PDFs of the page images. Navigation through the e-book is done via a web interface and two options are given. The default option is a "logical" layout and a second is a "book

layout”, which maintains the same page order as the printed book. The description below follows the book layout.

As in the Nautical Almanac, the major portion of the Air Almanac is devoted to a tabulation of GHA and declination. However, in the Air Almanac values are listed at intervals of 10 minutes, to a precision of 0.1' for the Sun and Aries, and to a precision of 1' for the Moon and the planets. Values are given for the Sun, first point of Aries (GHA only), the three navigational planets most favorably located for observation, and the Moon. The magnitude of each planet listed is given at the top of its column, and the percentage of the Moon's disc illuminated, waxing (+) or waning(-), is given at the bottom of each page. The magnitude of each planet listed is given at the top of its column. Values for the first 12 hours of the day are given on the right-hand page, and those for the second half of the day on the left-hand page. Each daily page includes the UT of moonrise and moonset on the Greenwich meridian for latitudes from 72° N to 60° S; a “half-day” difference column provides data to find the time of moonrise and moonset at any longitude. In addition, each page has a critical table of the Moon's parallax in altitude, and below this the semidiameter of the Sun and Moon, and the percentage of the Moon's disc illuminated and whether it is waxing (+) or waning (-).

Critical tables for interpolation for GHA are given on

the inside front cover, which also has an alphabetical listing of the 57 navigational stars, with the number, magnitude, yearly mean SHA, and yearly mean declination of each. The same interpolation table and star list are printed on a flap which follows the daily pages. This flap also contains a star chart, a star list with the same data as the other, but in increasing navigational number order, and a table for interpolation of the UT of moonrise and moonset for longitude.

Following the flap are instructions for the use of the almanac; a list of symbols and abbreviations in English, French, and Spanish; a list of time differences between Greenwich and other places; monthly sky diagrams by latitude and time of day; planet location diagrams; star recognition diagrams for periscopic sextants; sunrise, sunset, and civil twilight tables; rising, setting, and depression graphs; semiduration graphs of Sunlight, twilight, and Moonlight in high latitudes; a single Polaris correction table; a list of 173 stars by number and Bayer designation (also popular name where there is one), giving the SHA and declination each month (to a precision of 0.1'), and the magnitude; tables for interpolation of GHA Sun and GHA φ ; a table for converting arc to time; a refraction correction table; a Coriolis correction table; and on the inside back cover, an aircraft standard dome refraction table; a correction table for dip of the horizon.

USING THE ALMANACS

1703. Entering Arguments

The time used as an entering argument in the almanacs is UT, (formerly referred to as GMT), which is equivalent to 12^h + GHA of the mean Sun. This scale may differ from the broadcast time signals by an amount of 0.9^s which, if ignored, will introduce an error of up to 0.2' in longitude determined from astronomical observations. The difference arises because the time argument depends on the variable rate of rotation of the Earth while the broadcast time signals are now based on atomic time. Leap seconds, that is step adjustments of exactly one second are made to the time signals as required (primarily at 24h on December 31 and June 30) so that the difference between the time signals and UT, as used in the almanacs, may not exceed 0.9^s. If observations to a precision of better than 1^s are required, corrections must be obtained from coding in the signal, or from other sources. The correction may be applied to each of the times of observation. Alternatively, the longitude, when determined from observations, may be corrected by the corresponding amount shown in Table 1703.

The main contents of the almanacs consist of data from which the GHA and the declination of all the bodies used for navigation can be obtained for any instant of UT. The

<i>Correction to time signals</i>	<i>Correction to longitude</i>
-0.9 ^s to -0.7 ^s	0.2' to east
-0.6 ^s to -0.3 ^s	0.1' to east
-0.2 ^s to +0.2 ^s	no correction
+0.3 ^s to +0.6 ^s	0.1' to west
+0.7 ^s to +0.9 ^s	0.2' to west

Table 1703. Corrections to time.

LHA can then be obtained with the formula:

$$\begin{aligned} \text{LHA} &= \text{GHA} + \text{east longitude} \\ \text{LHA} &= \text{GHA} - \text{west longitude} \end{aligned}$$

For the Sun, Moon, and the four navigational planets, the GHA and declination are tabulated directly in the *Nautical Almanac* for each hour of UT throughout the year; in the *Air Almanac*, the values are tabulated for each whole 10 m of UT. For the stars, the SHA is given, and the GHA is obtained from:

$$\text{GHA Star} = \text{GHA } \varphi + \text{SHA Star.}$$

The SHA and declination of the stars change slowly and may be regarded as constant over periods of several days or even months if lesser accuracy is required. The SHA and declination of stars tabulated in the *Air Almanac* may be considered constant to a precision of 1.5' to 2' for the period covered by each of the volumes providing the data for a whole year, with most data being closer to the smaller value. GHA Υ , or the GHA of the first point of Aries (the vernal equinox), is tabulated for each hour in the *Nautical Almanac* and for each whole 10^m in the *Air Almanac*. Permanent tables list the appropriate increments to the tabulated values of GHA and declination for the minutes and seconds of time.

In the *Nautical Almanac*, the permanent table for increments also includes corrections for ν , the difference between the actual change of GHA in one hour and a constant value used in the interpolation tables; and d , the average hourly change in declination.

In the *Nautical Almanac*, ν is always positive unless a negative sign (-) is shown. This occurs only in the case of Venus. For the Sun, the tabulated values of GHA have been adjusted to reduce to a minimum the error caused by treating ν as negligible; there is no ν tabulated for the Sun.

No sign is given for tabulated values of d ; whether to add or subtract a correction to the declination must be done via inspection of the increasing or decreasing trend of the declination values.

In the *Air Almanac*, the tabulated declination values, except for the Sun, are those for the middle of the interval between the time indicated and the next following time for which a value is given, making interpolation unnecessary. Thus, it is always important to take out the GHA and declination for the time immediately before the time of observation.

In the *Air Almanac*, GHA Υ and the GHA and declination of the Sun are tabulated to a precision of 0.1'. If these values are extracted with the tabular precision, the "Interpolation of GHA" table on the inside front cover (and flap) should not be used; use the "Interpolation of GHA Sun" and "Interpolation of GHA Aries" tables, as appropriate. These tables are found on pages A164 and A165.

1704. Finding GHA and Declination of the Sun

Nautical Almanac: Enter the daily page table with the whole hour before the given GMT, unless the exact time is a whole hour, and take out the tabulated GHA and declination. Inspect the trend in the following declination value to determine if declination is increasing or decreasing; this is needed to know whether to add or subtract the d correction. Also record the d value given at the bottom of the declination column. Next, enter the increments and corrections table for the number of minutes of GMT. If there are seconds, use the next earlier whole minute. On the line corresponding to the seconds of GMT, extract the value from the Sun-Planets column. Add this to

the value of GHA from the daily page. This is GHA of the Sun. Next, enter the correction table for the same minute of GMT with the d value and take out the correction. Apply the d correction, either adding or subtracting (as determined earlier by inspection of the tabulated declination values), to the declination from the daily page. This is the declination.

The correction table for GHA of the Sun is based upon a rate of change of 15° per hour, the average rate during a year. At most times the rate differs slightly. The slight error is minimized by adjustment of the tabular values. The d value is the average hourly amount that the declination changes on the middle day of the three shown.

Air Almanac: Enter the daily page with the whole 10^m preceding the given GMT, unless the time is itself a whole 10^m, and extract the GHA. The declination is extracted without interpolation from the same line as the tabulated GHA or, in the case of planets, the top line of the block of six. If the values extracted are rounded to the nearest minute, enter the "Interpolation of GHA" table on the inside front cover (and flap), using the "Sun, etc." entry column, and take out the value for the remaining minutes and seconds of GMT. If the entry time is an exact tabulated value, use the correction listed half a line above the entry time. Add this correction to the GHA taken from the daily page. This is GHA. No adjustment of declination is needed. If the values are extracted with a precision of 0.1', the table for interpolating the GHA of the Sun to a precision of 0.1' must be used (page A164). Again no adjustment of declination is needed.

1705. Finding GHA and Declination of the Moon

Nautical Almanac: Enter the daily page table with the whole hour before the given GMT, unless this time is itself a whole hour, and extract the tabulated GHA and declination. Record the corresponding ν and d values tabulated on the same line, and determine whether the d correction is to be added or subtracted, by inspecting the trend in the next tabular declination value. The ν value of the Moon is always positive (+) but it is not marked in the almanac. Next, enter the increments and corrections table for the minutes of GMT, and on the line for the seconds of GMT, take the GHA correction from the Moon column. Then, enter the correction table for the same minute with the ν value, and extract the correction. Add both of these corrections to the GHA from the daily page. This is the GHA of the Moon. Then, enter the same correction table page with the d value and extract the corresponding d correction. Apply the d correction, either adding or subtracting (as determined earlier by inspection of the trend of the tabulated declination values), to the declination from the daily page. This is the declination of the Moon.

The correction table for GHA of the Moon is based upon the minimum rate at which the Moon's GHA increases, 14°19.0' per hour. The ν correction adjusts for the actual rate. The ν value is the difference between the

minimum rate and the actual rate during the hour following the tabulated time. The d value is the amount that the declination changes during the hour following the tabulated time.

Air Almanac: Enter the daily page with the whole 10^m next preceding the given GMT, unless this time is a whole 10^m , and extract the tabulated GHA and the declination without interpolation. Next, enter the “Interpolation of GHA” table on the inside front cover, using the “Moon” entry column, and extract the value for the remaining minutes and seconds of GMT. If the entry time is an exact tabulated value, use the correction given half a line above the entry time. Add this correction to the GHA taken from the daily page to find the GHA at the given time. No adjustment of declination is needed.

The declination given in the table is correct for the time 5 minutes later than tabulated, so that it can be used for the 10-minute interval without interpolation, to an accuracy to meet most requirements. Declination changes much more slowly than GHA. If greater accuracy is needed, it can be obtained by interpolation, remembering to allow for the 5 minutes.

1706. Finding GHA and Declination of a Planet

Nautical Almanac: Enter the daily page table with the whole hour before the given GMT, unless the time is a whole hour, and extract the tabulated GHA and declination. Record the v and d values given at the bottom of each of these columns; determine whether the d correction is to be added or subtracted by inspecting the trend in the declination. Next, enter the increments and corrections table for the minutes of GMT, and on the line for the seconds of GMT, take the GHA correction from the Sun-planets column. Next, enter the correction table with the v value and extract the correction, giving it the sign of the v value. Add the first correction to the GHA from the daily page, and apply the second correction in accordance with its sign. This is the GHA of the planet. Then enter the increments and correction table for the same minute with the d value, and extract the correction. Apply the d correction, either adding or subtracting (as determined earlier by inspection of the tabulated declination values), to the declination from the daily page to find the declination of the planet at the given time.

The correction table for GHA of planets is based upon the mean rate of the Sun, 15° per hour. The v value is the difference between 15° and the average hourly change of GHA of the planet on the middle day of the three shown. The d value is the average hourly amount the declination changes on the middle day. Venus is the only body listed which ever has a negative v value.

Air Almanac: Enter the daily page with the whole 10^m before the given GMT, unless this time is a whole 10^m , and extract the tabulated GHA and declination, without interpolation. The tabulated declination is correct for the time 30^m later than tabulated, so interpolation during the hour

following tabulation is not needed for most purposes. Next, enter the “Interpolation of GHA” table on the inside front cover, using the “Sun, etc.” column, and take out the value for the remaining minutes and seconds of GMT. If the entry time is an exact tabulated value, use the correction half a line above the entry time. Add this correction to the GHA from the daily page to find the GHA at the given time. No adjustment of declination is needed.

1707. Finding GHA and Declination of a Star

If the GHA and declination of each navigational star were tabulated separately, the almanacs would be several times their present size. But since the sidereal hour angle and the declination are nearly constant over several days (to the nearest $0.1'$) or months (to the nearest $1'$), separate tabulations are not needed. Instead, the GHA of the first point of Aries, from which SHA is measured, is tabulated on the daily pages. In the *Nautical Almanac*, a single listing of SHA and declination for the 57 navigational stars is given for each double page (computed at 12 UT1 of the middle day); monthly values are given for 173 bright stars (pages 268 through 273). In the *Air Almanac*, the yearly mean SHA and declinations are listed on the inside cover and flap; for higher accuracy, monthly values are tabulated for the 173 navigation stars (pages A158 through A163). Finding the GHA is similar to finding the GHA of the Sun, Moon, and planets.

Nautical Almanac: Enter the daily page table with the whole hour before the given GMT, unless this time is a whole hour, and extract the tabulated GHA of Aries. Also record the tabulated SHA and declination of the star from the listing on the left-hand daily page. Next, enter the increments and corrections table for the minutes of GMT, and, on the line for the seconds of GMT, extract the GHA correction from the Aries column. Add this correction and the SHA of the star to the GHA Υ on the daily page to find the GHA of the star at the given time. Subtraction of 360° may be necessary to keep GHA between 0° and 360° . No adjustment of declination is needed.

The SHA and declination of 173 stars, including Polaris and the 57 listed on the daily pages, are given for the middle of each month. For a star not listed on the daily pages, this is the only almanac source of this information. Interpolation in this table is not necessary for ordinary purposes of navigation, but is sometimes needed for precise results.

Air Almanac: Enter the daily page with the whole 10^m before the given GMT, unless this is a whole 10^m , and extract the tabulated GHA Υ . Next, enter the “Interpolation of GHA” table on the inside front cover, using the “Sun, etc.” entry column, and extract the value for the remaining minutes and seconds of GMT. If the entry time is an exact tabulated value, use the correction given half a line above the entry time. From the tabulation at the left side of the same page, extract the SHA and declination of the star. Add the GHA from the daily page and the two values

taken from the inside front cover to find the GHA at the given time. No adjustment of declination is needed. Should higher precision be needed, use the SHA and declination

values on pages A158 to A163, and the interpolation of GHA Aries table on A165.

RISING, SETTING, AND TWILIGHT

1708. Rising, Setting, and Twilight

In both *Air* and *Nautical Almanacs*, the times of sunrise, sunset, moonrise, moonset, and twilight information, at various latitudes between 72°N and 60°S, is listed to the nearest whole minute. By definition, rising or setting occurs when the upper limb of the body is on the visible horizon, assuming standard refraction for zero height of eye. Because of variations in refraction and height of eye, computation to a greater precision than 1 minute of time is not justified.

In high latitudes, some of the phenomena do not occur during certain periods. Symbols are used in the almanacs to indicate:

1. Sun or Moon does not set, but remains continuously above the horizon, indicated by an open rectangle.
2. Sun or Moon does not rise, but remains continuously below the horizon, indicated by a solid rectangle.
3. Twilight lasts all night, indicated by 4 slashes (////).

Both the *Nautical Almanac* and the *Air Almanac* provide graphs for finding the times of rising, setting, or twilight in polar regions.

In the *Nautical Almanac*, sunrise, sunset, and twilight tables are given only once for the middle of the three days on each page opening. Moonrise and moonset tables are given for each day. For many purposes this information can be used for all three days. For high precision needs, interpolation tables are provided (page xxxii). In the *Air Almanac*, sunrise, sunset, and twilight tables are given every three days (pages A130-A145). Graphs and tables are provided to compute phenomena at altitudes up to 60,000 feet. Moonrise and moonset tables are given daily in the main table.

The tabulations are in UT on the Greenwich meridian. They are approximately the LMT of the corresponding phenomena on other meridians; they can be formally interpolated if desired. The conversion of UT to LMT and vice versa of a phenomenon is obtained by the formula:

$$UT = LMT + W \text{ Longitude}$$

$$UT = LMT - E \text{ Longitude}$$

To use this formula, convert the longitude to time using the table on page i or by computation, and add or subtract as indicated.

1709. Finding Times of Sunrise and Sunset

To find the time of sunrise or sunset in the *Nautical*

Almanac, enter the table on the daily page, and extract the LMT for the latitude next smaller than your own (unless it is exactly the same). Apply a correction from Table I on almanac page xxxii to interpolate for latitude, determining the sign by inspection. Then convert LMT to ZT using the difference of longitude between the local and zone meridians.

For the *Air Almanac*, the procedure is the same as for the *Nautical Almanac*, except that the LMT is taken from the tables of sunrise and sunset instead of from the daily page, and the latitude correction is by linear interpolation.

The tabulated times are for the Greenwich meridian. Except in high latitudes near the time of the equinoxes, the time of sunrise and sunset varies so little from day to day that no interpolation is needed for longitude. In high latitudes interpolation is not always possible. Between two tabulated entries, the Sun may in fact cease to set. In this case, the time of rising and setting is greatly influenced by small variations in refraction and changes in height of eye.

1710. Twilight

Morning twilight ends at sunrise, and evening twilight begins at sunset. The time of the darker limit can be found from the almanacs. The time of the darker limits of both civil and nautical twilights (center of the Sun 6° and 12°, respectively, below the celestial horizon) is given in the *Nautical Almanac*. The *Air Almanac* provides tabulations of civil twilight from 60°S to 72°N. The brightness of the sky at any given depression of the Sun below the horizon may vary considerably from day to day, depending upon the amount of cloudiness, haze, and other atmospheric conditions. In general, the most effective period for observing stars and planets occurs when the center of the Sun is between about 3° and 9° below the celestial horizon. Hence, the darker limit of civil twilight occurs at about the mid-point of this period. At the darker limit of nautical twilight, the horizon is generally too dark for good observations.

At the darker limit of astronomical twilight (center of the Sun 18° below the celestial horizon), full night has set in. The time of this twilight is given in the *Astronomical Almanac*. Its approximate value can be determined by extrapolation in the *Nautical Almanac*, noting that the duration of the different kinds of twilight is proportional to the number of degrees of depression for the center of the Sun. More precise determination of the time at which the center of the Sun is any given number of degrees below the celestial horizon can be determined by a large-scale diagram on the plane of the celestial meridian, or by

computation. Duration of twilight in latitudes higher than 65°N is given in a graph in both the *Nautical* and the *Air Almanac*.

In both *Nautical* and *Air Almanacs*, the method of finding the darker limit of twilight is the same as that for sunrise and sunset.

Sometimes in high latitudes the Sun does not rise but twilight occurs. This is indicated in the almanacs by a solid black rectangle symbol in the sunrise and sunset column. To find the time of beginning of morning twilight, subtract half the duration of twilight as obtained from the duration of twilight graph from the time of meridian transit of the Sun; and for the time of ending of evening twilight, add it to the time of meridian transit. The LMT of meridian transit never differs by more than 16.4^m (approximately) from 1200. The actual time on any date can be determined from the almanac.

1711. Moonrise and Moonset

Finding the time of moonrise and moonset is similar to finding the time of sunrise and sunset, with one important difference. Because of the Moon's rapid change of declination, and its fast eastward motion relative to the Sun, the time of moonrise and moonset varies considerably from day to day. These changes of position on the celestial sphere are continuous and complex. For precise results, it would be necessary to compute the time of the phenomena at any given place by lengthy complex calculation. For ordinary purposes of navigation, however, it is sufficiently accurate to interpolate between consecutive moonrises or moonsets at the Greenwich meridian. Since apparent motion of the Moon is westward, relative to an observer on the Earth, interpolation in west longitude is between the phenomenon on the given date and the following one. In east longitude it is between the phenomenon on the given date and the preceding one.

To find the time of moonrise or moonset in the *Nautical Almanac*, enter the daily pages table with latitude and extract the LMT for the tabulated latitude next smaller than the observer's latitude (unless this is an exact tabulated value). Apply a correction from table I of almanac page xxxii to interpolate for latitude, determining the sign of the correction by inspection. Repeat this procedure for the day following the given date, if in west longitude; or for the day preceding, if in east longitude. Using the difference between these two times, and the longitude, enter table II of the almanac on the same page and take out the correction. Apply this correction to the LMT of moonrise or moonset at the Greenwich meridian on the given date to find the LMT at the position of the observer. The sign to be given the correction is such as to make the corrected time fall between the times for the two dates between which interpolation is being made. This is nearly always positive (+) in west longitude and negative (-) in east longitude. Convert the corrected LMT to ZT.

To find the time of moonrise or moonset by the *Air*

Almanac for the given date, determine LMT for the observer's latitude at the Greenwich meridian in the same manner as with the *Nautical Almanac*, except that linear interpolation is made directly from the main tables, since no interpolation table is provided. Extract, also, the value from the "Diff." column to the right of the moonrise and moonset column, interpolating if necessary. This "Diff." is the half-daily difference. The error introduced by this approximation is generally not more than a few minutes, although it increases with latitude. Using this difference, and the longitude, enter the "Interpolation of moonrise, moonset" table on flap F4 of the *Air Almanac* and extract the correction. The *Air Almanac* recommends taking the correction from this table without interpolation. The results thus obtained are sufficiently accurate for ordinary purposes of navigation. If greater accuracy is desired, the correction can be taken by interpolation. However, since the "Diff." itself is an approximation, the *Nautical Almanac* or computation should be used if accuracy is a consideration. Apply the correction to the LMT of moonrise or moonset at the Greenwich meridian on the given date to find the LMT at the position of the observer. The correction is positive (+) for west longitude, and negative (-) for east longitude, unless the "Diff." on the daily page is preceded by the negative sign (-), when the correction is negative (-) for west longitude, and positive (+) for east longitude. If the time is near midnight, record the date at each step, as in the *Nautical Almanac* solution.

As with the Sun, there are times in high latitudes when interpolation is inaccurate or impossible. At such periods, the times of the phenomena themselves are uncertain, but an approximate answer can be obtained by the Moonlight graph in the almanacs. With the Moon, this condition occurs when the Moon rises or sets at one latitude, but not at the next higher tabulated latitude. It also occurs when the Moon rises or sets on one day, but not on the preceding or following day. This latter condition is indicated in the *Air Almanac* by the symbol * in the "Diff." column.

Because of the eastward revolution of the Moon around the Earth, there is one day each synodical month (29¹/₂ days) when the Moon does not rise, and one day when it does not set. These occur near last quarter and first quarter, respectively. This day is not the same at all latitudes or at all longitudes, thus the time of moonrise or moonset found from the almanac may occasionally be the preceding or succeeding one to that desired (indicated by a time greater than 23^h 59^m). When interpolating near midnight, caution will prevent an error.

The effect of the revolution of the Moon around the Earth, generally, is to cause the Moon to rise or set later from day to day. The daily retardation due to this effect does not differ greatly from 50^m. However, the change in declination of the Moon may increase or decrease this effect. This effect increases with latitude, and in extreme conditions it may be greater than the effect due to revolution of the Moon. Hence, the interval between

successive moonrises or moonsets is more erratic in high latitudes than in low latitudes. When the two effects act in the same direction, daily differences can be quite large. When they act in opposite directions, they are small, and when the effect due to change in declination is larger than that due to revolution, the Moon sets earlier on succeeding days.

This condition is reflected in the *Air Almanac* by a negative “Diff.” If this happens near the last quarter or first quarter, two moonrises or moonsets might occur on the same day, one a few minutes after the day begins, and the other a few minutes before it ends. Interpolation for longitude is always made between consecutive moonrises or moonsets, regardless of the days on which they fall.

Beyond the northern limits of the almanacs the values can be obtained from a series of graphs given near the back of the books (pages 322-325 for *Nautical*, A153-A157 for

Air). For high latitudes, graphs are used instead of tables because graphs give a clearer picture of conditions, which may change radically with relatively little change in position or date. Under these conditions interpolation to practical precision is simpler by graph than by table. In those parts of the graph which are difficult to read, the times of the phenomena’s occurrence are uncertain, being altered considerably by a relatively small change in refraction or height of eye.

On all of these graphs, any given latitude is represented by a horizontal line and any given date by a vertical line. At the intersection of these two lines the duration is read from the curves, interpolating by eye between curves; see Figure 1711a for an example of a Semiduration of Moonlight plot for the month of January 2016.

SEMIDURATION OF MOONLIGHT 2016

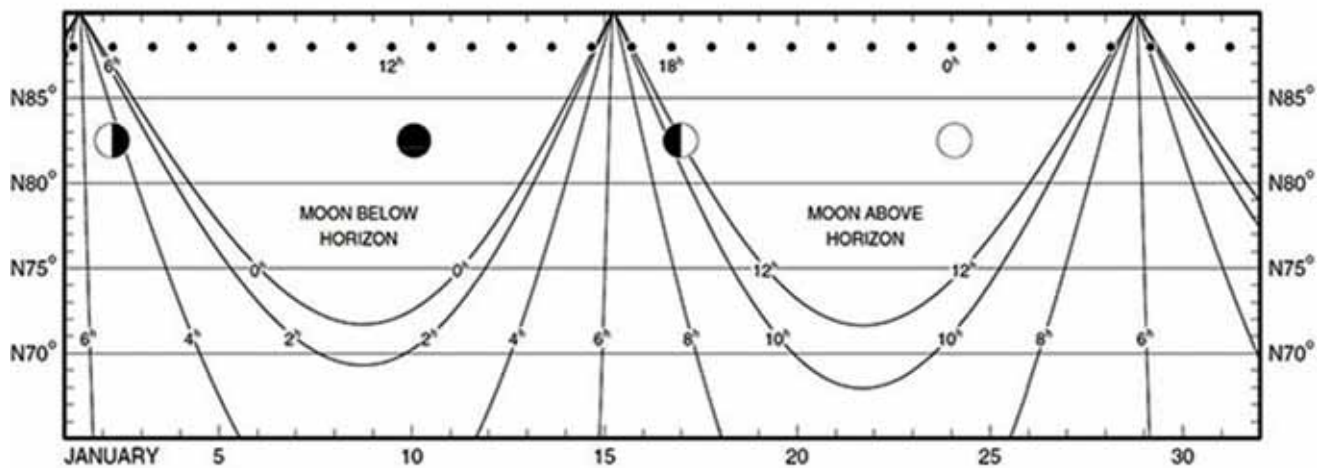

Figure 1711a. Semiduration of moonlight for high latitudes in January 2016.

The “Semiduration of Sunlight” graph gives the number of hours between sunrise and meridian transit or between meridian transit and sunset. The dot scale near the top of the graph indicates the LMT of meridian transit, the time represented by the minute dot nearest the vertical date-line being used. If the intersection occurs in the area marked “Sun above horizon,” the Sun does not set; and if in the area marked “Sun below horizon,” the Sun does not rise.

The “Duration of Twilight” graph gives the number of hours between the beginning of morning civil twilight (center of Sun 6° below the horizon) and sunrise, or between sunset and the end of evening civil twilight. If the Sun does not rise, but twilight occurs, the time taken from the graph is half the total length of the single twilight period, or the number of hours from beginning of morning twilight to LAN, or from LAN to end of evening twilight. If the intersection occurs in the area marked “continuous twilight or Sunlight,” the center of the Sun does not move

more than 6° below the horizon, and if in the area marked “no twilight nor Sunlight,” the Sun remains more than 6° below the horizon throughout the entire day.

The “Semiduration of Moonlight” graph gives the number of hours between moonrise and meridian transit or between meridian transit and moonset. The dot near the top of the graph indicates the LMT of meridian passage, and the spacing between each dot is approximately 50 minutes. The phase symbols indicate the date on which the principal Moon phases occur, the open circle indicating full Moon and the dark circle indicating new Moon. If the intersection of the vertical date-line and the horizontal latitude line falls in the “Moon above horizon” or “Moon below horizon” area, the Moon remains above or below the horizon, respectively, for the entire 24 hours of the day.

If approximations of the times of moonrise and moonset are sufficient, the semiduration of Moonlight is taken for the time of meridian passage (dots along top scale) and can

be used without adjustment. For example, to estimate moonrise on 19 January 2016 at latitude 70° N and the following moonset, see Figure 1711b. Using the dot along the top scale, the semiduration of moonlight is 10h at 70° N. The meridian passage itself is about at 20:30 LMT, found by adding 50 minutes to each successive dot after the 18h one. Approximate moonrise is the semiduration minus meridian passage, 10h - 20:30, or at 10:30 LMT. The following moonset is semiduration plus meridian passage,

10h + 20:30, or at 06:30 the following day. For more accurate results (seldom justified), the times on the required date and the adjacent date (the following date in W longitude and the preceding date in E longitude) should be determined, and an interpolation made for longitude, as in any latitude, since the intervals given are for the Greenwich meridian.

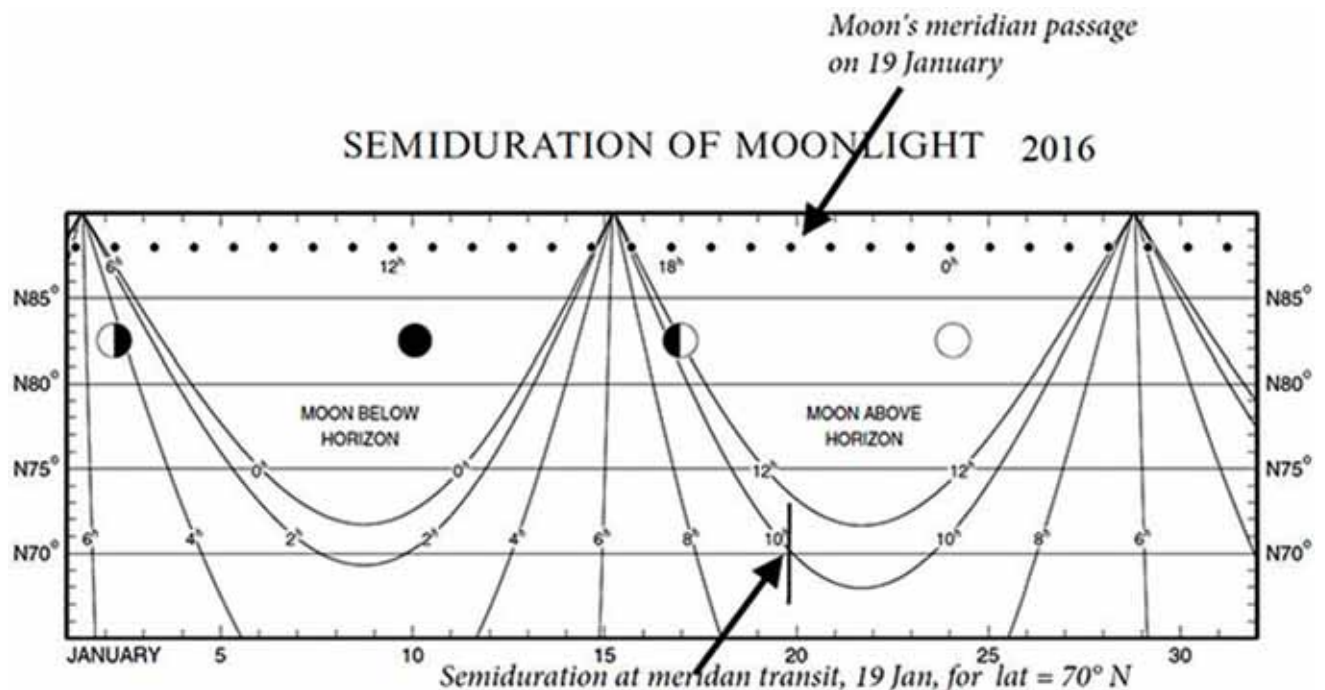

Figure 1711b. Moon's meridian passage on 19 January 2016.

Sunlight, twilight and Moonlight graphs are not given for south latitudes. Beyond latitude 65°S, the northern hemisphere graphs can be used for determining the semiduration or duration, by using the vertical dateline for a day when the declination has the same numerical value but opposite sign. The time of meridian transit and the phase of the Moon are determined as explained above, using the correct date. Between latitudes 60°S and 65°S, the solution is made by interpolation between the tables and the graphs.

Semiduration or duration can be determined graphically using a diagram on the plane of the celestial meridian, or by computation. When computation is used, solution is made for the meridian angle at which the required negative altitude occurs. The meridian angle expressed in time units is the semiduration in the case of sunrise, sunset, moonrise, and moonset; and the semiduration of the combined Sunlight and twilight, or the time from meridian transit at which morning twilight begins or evening twilight ends. For sunrise and sunset the altitude used is (-)50'. Allowance for height of eye can be made by algebraically subtracting (numerically adding) the dip correction from this altitude. The altitude used for twilight is (-)6°, (-)12°, or (-)18° for civil,

nautical, or astronomical twilight, respectively. The altitude used for moonrise and moonset is -34' - SD + HP, where SD is semidiameter and HP is horizontal parallax, from the daily pages of the *Nautical Almanac*.

Other methods of solution of these phenomena are available. If an internet connection is available, the US Naval Observatory website provides calculators (aa.usno.navy.mil/data/). Sunrise and sunset for latitudes from 76°N to 60°S can be derived using Table 4 of NOAA's *Tide Tables* publications.

1712. Rising, Setting, and Twilight on a Moving Craft

Instructions to this point relate to a fixed position on the Earth. Aboard a moving craft the problem is complicated somewhat by the fact that time of occurrence depends upon the position of the craft, which itself depends on the time. The US military can use STELLA, which calculates phenomena from a moving platform (see Section 1900), for others, at ship speeds, it is generally sufficiently accurate to make an approximate mental solution and use the position of the vessel at this time to make a more

accurate solution. If greater accuracy is required, the position at the time indicated in the second solution can be used for a third solution. If desired, this process can be repeated until the same answer is obtained from two consecutive solutions. However, it is generally sufficient to alter the first solution by 1^m for each 15' of longitude that

the position of the craft differs from that used in the solution, adding if west of the estimated position, and subtracting if east of it. In applying this rule, use both longitudes to the nearest 15'. The first solution is the **first estimate**; the second solution is the **second estimate**.

CHAPTER 18

SIGHT PLANNING

NEED FOR SIGHT PLANNING

1800. The Need for Sight Planning

One of the challenges of celestial navigation is sight planning. Good sight planning is essential to acquiring a good fix.

A single sight produces a **line of position (LOP)**. A fix, the determination of the observer's most likely position, requires at minimum two LOPs. The fix is the intersection of the LOPs. If the sights were perfectly accurate, then no further work would be required. However, no observation is perfectly accurate. A navigator experienced in taking sights with a sextant can, under ideal conditions, take sights accurate to a few tenths of an arc minute. Under typical shipboard conditions sights are expected to be accurate to about an arc minute. A navigator not experienced at taking sights can expect an accuracy of a few arc minutes. Sight planning is one tool for reducing errors in producing a fix. Good sight planning will reduce the effect of the errors from both taking the sights and on the derived fix.

There are several considerations that go into sight planning. Among them are:

- When should sights be taken?
- What bodies will be visible?
- What distribution of celestial bodies will produce the best fix?
- What is the best order in which to take the sights?

The process of sight planning can be broken down into three broad categories: general sight planning, daytime sight planning, and twilight sight planning.

1801. General Principles

Experienced navigators through history have come to understand that under normal conditions only about 70% of the visible sky is ideal for taking celestial observations. When it comes to sight planning it is important to appreciate that celestial body pre-selection will yield the best chance for achieving an accurate celestial fix of position when they come from bodies observed within certain altitude ranges and at certain times. For example, it is useful to understand that when selecting celestial bodies for observation, it can be difficult to accurately determine the true altitude of bodies lying low near the horizon due to refraction, while it can be equally daunting to accurately

determine a celestial LOP from a body near zenith because the assumption that a straight line of position approximates the body's circle of equal altitude begins to breakdown.

Except for sights of the Sun, Moon, and sometimes Venus and Jupiter, all other bodies used in celestial navigation sights can be measured only during nautical twilight, the period during which the center of the Sun is between 6° and 12° below the horizon. During this period the sky is dark enough to make out the celestial bodies used for sights, but bright enough that the horizon is well enough defined to take an accurate sight.

The process of taking sights is weather dependent. An accurate sight requires that both the body and the horizon below it be visible at the time the sight is taken. If either the body or the horizon is obscured, but still visible, a reduced accuracy sight may still be taken. Such a sight should be taken if it is the only option. A better option is to have an extended list of possible bodies to observe. The navigator can then select those bodies that are clearly visible with a well defined horizon below them.

The process of sight planning can be broken down into three broad categories: general sight planning, daytime sight planning, and twilight sight planning.

1802. Distribution of Bodies in Azimuth

The *Nautical Almanac* contains data for reducing sights of 179 bodies: the Sun, Moon, four planets, 57 navigational stars, and 116 supplemental stars (pp. 268-273). On average, there is one body for every 230 square degrees of sky, and these bodies are unevenly distributed on the sky. An accurate fix requires the observed bodies to be well distributed in azimuth.

Figure 1802a shows two LOPs for two objects whose azimuths are separated by 15°. The LOPs also intersect with an acute angle of 15°. The result is: it is difficult to determine where the two LOPs cross along the axis bisected by the acute angle. That is, there is a large uncertainty in the fix position in that direction. The uncertainty in the fix along the axis bisected by the oblique angle is approximately the same as it would be if the LOPs met at right angles.

Figure 1802b the two LOPs are perpendicular to each other. The result is that the uncertainty in the fix is the same in all directions. The closer the separation of the azimuths of two sights comes to perpendicularity the better the chance a fix will have minimum uncertainty. Finding two

a.

LOPs separated by 15°.

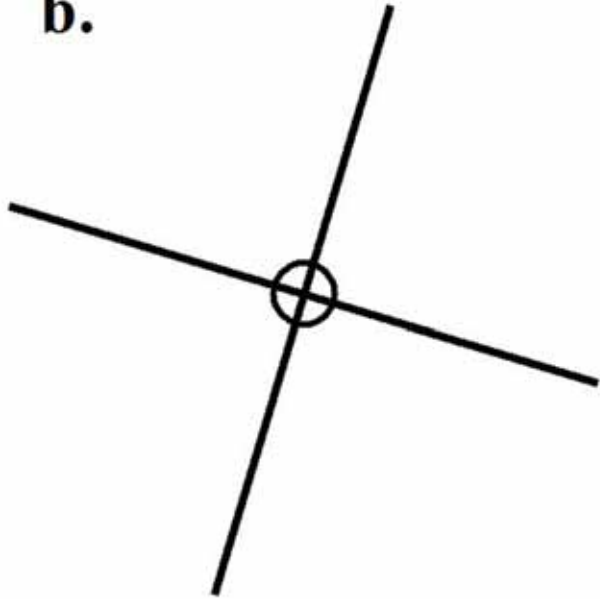
b.

LOPs separated by 90°.

Figure 1802a. The change of error ellipse with angle of intersection.

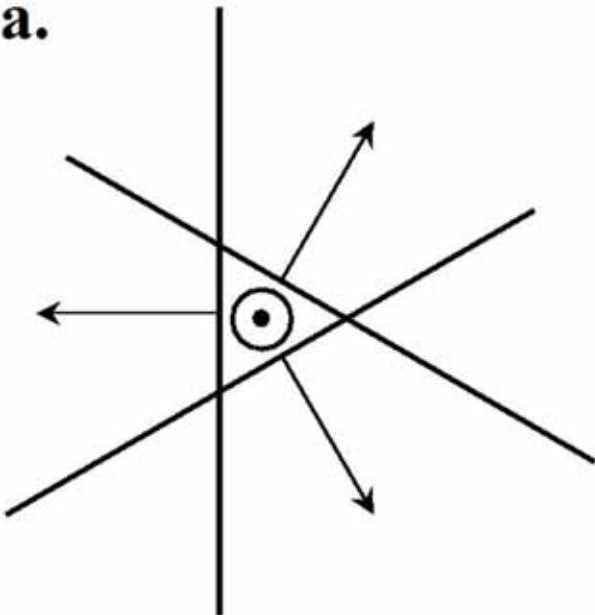
a.

Azimuths separated by 120°.

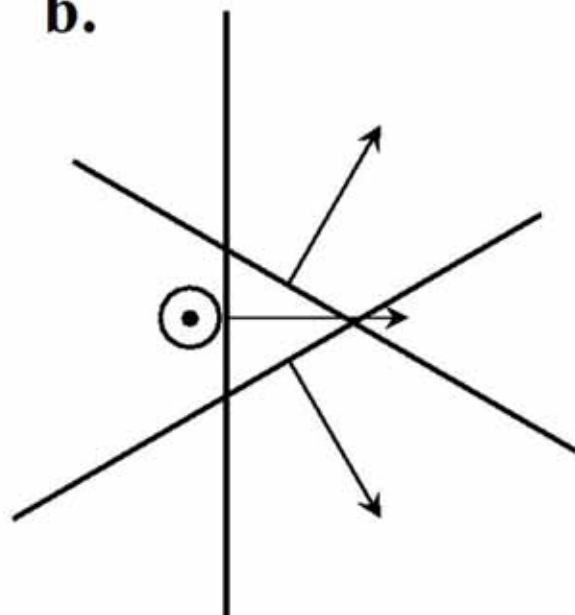
b.

Azimuths separated by 60°.

Figure 1802b. Effects of the azimuthal distribution of bodies and a systematic error on the most likely positions.

bodies with azimuths separated by exactly 90° is unlikely, so an acute angle of at least 30° is recommended to reduce the uncertainty along the axis that bisects the acute angle of two LOPs.

Sights well distributed in azimuth also act to cancel out systematic errors in determining H_o such as an incorrect index correction (IC) or error in dip. For example, Figure 1802a shows three LOPs made from bodies separated by 120° in azimuth. A systematic error in determining H_o will move the LOPs in a direction perpendicular to the LOPs themselves, indicated by the arrows. A systematic error will move all of the LOPs the same amount in directions distributed 120° in azimuth. The result is the most likely position for the fix remains at the center of the “cocked hat”. In Figure 1802b, the three LOPs were plotted from bodies distributed by 60° in azimuth. The resulting “cocked hat” looks identical to the one in Figure 1802a. A systematic error, however, will move all of the LOPs the same amount in directions distributed in azimuth by 60° on either side of the center of the distribution. The result is that the most likely position for the fix is no longer at the center of the “cocked hat”. The most likely position may even lie outside of the “cocked hat” altogether if the systematic error is more than a few tenths of an arc minute.

1803. Altitude of Bodies

Bodies at high altitudes are difficult to observe. They can be a challenge to acquire, to “bring to the horizon” with a sextant, and to determine their approximate azimuth to measure an accurate H_s . As the body gets closer to the zenith the assumption that the circle of equal distances can be approximated by an LOP breaks down. Sights of a body taken at high altitudes may also require the use of more complicated procedures, such as the use of second differences when calculating H_c . Taking sights of body at high altitudes, greater than 75° , should be avoided for these reasons.

Refraction affects all observations. Refraction forms part of the corrections for both dip and apparent altitude. Refraction is larger and the correction becomes more uncertain for bodies near the horizon. The correction for non-standard air temperature and pressure can be more than $1'$ for a sight made within 5° of the horizon and can still be several tenths of an arc minute for a sight made within 10° of the horizon.

The amount of atmosphere the light has to pass through for a body observed near the horizon is greater than for a body observed at a greater altitude. A body viewed near the horizon will appear dimmer and redder because the light is absorbed or scattered by the atmosphere. Taking sights of bodies at low altitudes, less than approximately 15° , should be avoided for these reasons.

Correcting for non-standard air pressure and temperature does not guarantee that a sight will have no refraction error. The apparent position of the horizon itself is subject

to phenomena such as temperature inversions. There are three things a navigator can do to reduce any systematic errors caused by uncorrected refraction:

1. Make sure the observations are well distributed in azimuth. At sea, it is usually the case that the factors that contribute to refraction are similar in all directions. Taking sights well distributed in azimuth will cause the systematic errors to cancel out.
2. Take the sights from a place close to the sea surface, if possible. Almost all of the abnormal refraction encountered is caused by that part of the atmosphere between the observer's eye and the surface of the sea. Reducing the observer's height decreases the distance to the horizon. An observer close to the sea surface will have a nearby horizon, which is more likely to have similar refraction conditions in all directions.
3. Observe celestial bodies with similar altitudes, all greater than 15° . Bodies at the same altitude have the same total values for refraction. So, the systematic effect of errors in computed refraction will tend to cancel out if the bodies are well distributed in azimuth. The change in refraction angle is small, except near the horizon, so relative altitude is a minor consideration when choosing which bodies to use.

1804. Brightness of Bodies

One source of systematic error is the **personal equation**, that is how the individual judges the position of an object that does not appear to be a perfect point. This judgment of position varies from individual to individual. One person might tend to favor an “upper edge”, while another favors a “lower edge”, etc.

A bright object always appears somewhat larger than a dim one with a similar apparent size, seen against the same background. This property is called *irradiation*, and is a result of the way the brain interprets what it sees. Irradiation depends more on the difference in brightness between object and background than on the apparent size of the body. So, it is particularly striking for point sources such as stars. If possible, select bodies that are approximately the same brightness, to minimize the effect of personal error arising from irradiation. This effect is usually small, so it is of less importance than other considerations in the selection of bodies for sights.

1805. Number of Sights and Number of Bodies

One method to reduce the random error in determining an LOP is to take a number of observations of the same body over a short period of time. Averaging these observations together into a single sight, taking into account the

change in H_s with time, reduces random error with the square root of the number of observations. Averaging four observations into a sight reduces the random error to one-half that of a single observation sight and averaging nine observations into a sight reduces the random error to one-third that of a single observation. The incremental reduction in the random error quickly diminishes with the number of sights. Averaging together four or five observations into a single sight is about optimum.

The common method of averaging sights is the fit-slope method, e.g. Burch, D. 2015, *Celestial Navigation, Second Edition* (Seattle, Starpath Pub.) pp. 176-177. The fit-slope method is a graphical approximation of a linear least-squares method, e.g. Bevington, P.R. and Robinson, D.K. 1992, *Data Reduction and Error Analysis for the Physical Sciences*, (Boston, McGraw-Hill), Chapter 6. These methods assume that the rate of change of H_s is constant. Usually, this is a good assumption over a single sight session. But if the body is near transit, $Z_n = 0^\circ$ or $Z_n = 180^\circ$, the rate of change of H_s may be changing quickly. In this case these linear methods will fail. But if the observed body *does* transit during the sighting session, the vessel's position can be determined using the same method to determine LAN (Sections 1910 and 1911).

Another way to perform this task is to reduce all the observations made of the same object at an observing session as individual sights, and then average together the resulting values for a and Z_n . This second method consumes more time in the reduction of the individual observations, but it removes the difficulty of accounting for the change in H_s with time required for averaging together the observations.

It is preferable to take observations in a round-robin fashion when taking sights of more than one body at a session. Taking consecutive observations of different bodies helps assure that all the bodies are observed at least once should a sudden change in weather put an end to the observation of one or more bodies. Taking non-consecutive observations of a body helps to remove systematic errors in its observations by adding a randomizing factor to the sight taking.

Taking sights of more than two bodies can significantly reduce the random error of a fix just as taking more than a single observation can reduce the random error in an *LOP*. There are two parameters to be determined, latitude and

longitude, involved in a fix. So the random error of a fix is reduced by the square root of the number of sights minus two. Determining a fix from five or six sights is about optimum to reduce the random error in a fix

By averaging a number of observations into a single sight and then combining it with other sights into a single fix, the navigator can significantly reduce the uncertainty of the vessel's position.

The difference of a course of advance and the track made good for a running fix results in a less accurate fix than one made from taking sights of two bodies at a single observing session. The best method for reducing error in a running fix is to average together multiple observations, particularly those of the latter observing session, to improve the accuracy of the *LOP*.

1806. Precomputation

Precomputation is the practice of determining the predicted values of phenomena using estimated values for the time and position and data from the almanac. Precomputed values usually include times of rise and set of the Sun and Moon, the time of local apparent noon, the times and duration of twilight, and the H_c 's and Z_n 's of those bodies being considered for sight observations.

Precomputing the H_c and Z_n of a body for a sight serves two purposes:

1. It determines if the selected bodies provide a good distribution in azimuths. For a running fix using a single body, it determines how much time must elapse between sights to get an acceptable minimum change in azimuth of the body.
2. It eases the process of identification. Set the sextant to the precomputed H_c and face the precomputed Z_n . The chosen object will usually stand out in the reflection of the index mirror when the horizon is viewed through the horizon glass. This practice is particularly helpful in a crowded star field at twilight or when trying to pick out Venus, or occasionally Jupiter, against the bright daytime background.

DAYLIGHT SIGHT PLANNING

1807. Sun Sights

The principal activity of daylight celestial navigation is sighting the Sun to determine a vessel's position from running fixes and latitude from H_o at local apparent noon. Precomputing the Sun's expected H_c and Z_n at various times throughout the day makes it possible to determine the optimum times to take sights for both of these activities.

For example, in the Torrid Zone (tropics) the Sun's az-

imuth changes slowly for most of the morning and most of the afternoon switching rapidly from east to west around local apparent noon. To achieve a good running fix, sights need to be obtained before, near-to, and after local apparent noon. Near the equator, the change in azimuth is within 30° of 180° from February through April and August through October. During these periods a sight near local apparent noon (when the Sun's azimuth is near 0° or 180°) is essential for a good running fix. At high latitudes (north or south), on

the other hand, the motion of the Sun is mostly in azimuth, at approximately $15^\circ/\text{hr}$. So, a good running fix from the Sun can be made from two sights as long as at least two and fewer than ten hours have elapsed between sights and the Sun is high enough above the horizon to take an accurate sight.

Occasionally, it is necessary to take a Sun sight when it is near the horizon, to make a compass check for example. Precomputing the time and Z_n of sunrise or sunset are useful to provide an approximate time and azimuth for making such an observation. If the Sun is more than one or two degrees above the horizon, an accurate sight for H_s as well as Z_n can be determined as long as corrections are made for the change in refraction from non-standard temperature and air pressure. The upper limb of the Sun can be observed to further reduce possible complications from non-standard refraction.

1808. Moon Sights

When the Moon is more than a few days from New Moon it is bright enough to be easily visible during the daytime. It is also well separated from the Sun. It is best situated for daytime sights around the times of First Quarter (age 6 to 8 days) and Last Quarter (age 21 to 23 days). Near Full Moon the Sun and Moon are opposite each other in the sky, so the resulting $LOPs$ may be nearly parallel and the resulting fix would be poor. Instead, sights of the Full Moon should be combined with sights of celestial bodies other than the Sun.

It is more difficult to observe and make accurate measurements of the dark side of the Moon than of its bright side. Select the lighted limb when taking sights, and avoid taking sights when the "horns" of either the lighted or unlighted side point parallel to the horizon as in Figure 1808.

Sight Upper Limb
for Gibbous Moon

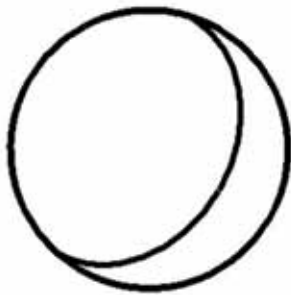

Sight Lower Limb
for Crescent Moon

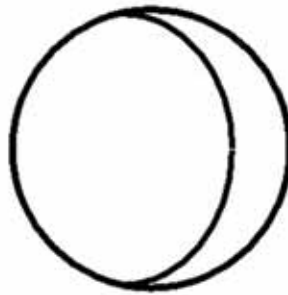

Difficult to Sight

Sight Upper Limb
for Crescent Moon

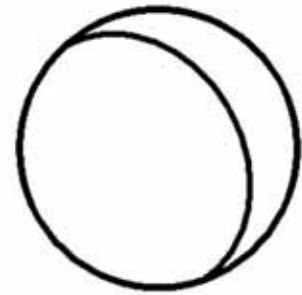

Sight Lower Limb
for Gibbous Moon

Figure 1808. Where to sight Moon with phase.

The local times of moonrise and moonset at 0° longitude are tabulated as a function of latitude for each day in the daily pages of the *Nautical Almanac*. The tabulation interval is 10° from the equator to latitude 30° , 5° from latitude 30° to latitude 50° , and 2° from latitude 50° to the limit for each hemisphere. Times of moonrise and moonset at high northern latitudes, 65° N to the North Pole, can be estimated using the semiduration of moonlight graph on pages 323 through 325 of the *Nautical Almanac*. Interpolation in both latitude and change in time of the phenomenon with longitude need to be performed to determine the LMT of moonrise or moonset. The Moon's phase and age at 12^{h} UT for each day are also tabulated on the daily pages.

1809. Planet Sights

Venus can be observed during the daytime when it is well separated from the Sun, particularly when its altitude is greater than the Sun's. Jupiter can also occasionally be observed during the daytime. Both planets can be observed immediately after sunset or before sunrise rather than waiting for nautical twilight. The best way to find Venus against the bright daytime sky is to precompute its H_c and Z_n , set the sextant for the expected altitude, and then use a compass to view along the expected azimuth.

The navigational planets move against the backdrop of the "fixed" stars from night to night, but their motions are small enough that they can be found in the same general area of the sky for several weeks. Also, they are bright

enough to be easily identifiable. One way to take advantage of these properties when using an aid such as a star finder is

to mark the planets positions at the expected middle of a voyage.

TWILIGHT SIGHT PLANNING

1810. Determining the Period of Twilight

Good sight planning is essential to make good use of the short period of nautical twilight for taking sights and minimize errors. Sight planning for twilight observations consists of three tasks:

1. Determine the period of nautical twilight.
2. Select the celestial bodies to be observed.
3. Determine the order in which to observe the bodies.

The length of the period of nautical twilight is a function of latitude and time of year. For most practical celestial navigation work, it lasts between 24 minutes in the tropics to an hour or more at high latitudes (near the poles, twilight can last days or weeks). Local weather conditions such as clouds and fog may significantly modify the period during which sights may be taken. During the period of nautical twilight only the brightest celestial bodies are visible.

The daily pages of the *Nautical Almanac* tabulate the LMT of beginning of morning nautical and civil twilight and the ending of evening civil and nautical twilights, to the nearest minute, for the middle of each three-day period from N 72° to S 60°. The tabulation interval is 10° from the equator to latitude 30°, 5° from latitude 30° to latitude 50°, and 2° from latitude 50° to the limit for each hemisphere. Times of twilight at high northern latitudes, 65° N to the North Pole, can be estimated using the semiduration of sunlight graph on page 322 of the *Nautical Almanac*. These intervals are adequate to interpolate the LMT twilight times to the DR latitude. It is advisable to also interpolate the times of twilight between the values on the current page and either the preceding or subsequent page if:

1. the latitude is greater than 20°,
2. the time of the phenomenon is more than 18 hours from the UT of the middle of the three-day interval, and
3. the date is within two months of either the vernal equinox (March 21) or the autumnal equinox (September 23).

1811. Twilight Moon Sights

When the Moon is between about 5 and 24 days old it is bright enough that it visibly lights the sea surface near the Moon's azimuth. Confusion between the horizon and the glint of moonlight off of the sea surface closer to the observer may occur at these times. A sight taken where the lighted sea is mistaken for the horizon will result in a value of *Hs* that is too high. To reduce this problem, twilight

sights of the Moon or other bodies with a similar azimuth should be taken, if possible, shortly after sunset or before sunrise when the horizon is easily distinguishable and the glare of moonlight is minimal. If a sight must be taken when there is significant glare:

- Observe from a position near the sea surface. A sight taken near the sea surface has a closer horizon, so the effect of the glare off the sea surface is minimized.
- Check the horizon under the Moon with a powerful pair of binoculars to determine if the glare extends to the apparent horizon.

1812. Selection of the Celestial Bodies for Sights

The most important consideration in selecting bodies for a fix is to ensure that the bodies are well distributed in azimuth. A fix from twilight observations alone requires sights of a minimum of two celestial bodies. Separating the bodies by at least 30° degrees in azimuth is desired to improve the acute angle of the intersection between *LOPs*. A fix made from at least three bodies that are well distributed in azimuth minimizes systematic errors in determining *Ho*. Observing four to six bodies significantly reduces the uncertainty of a fix. Precomputing the approximate altitudes and azimuths for eight to ten bodies will provide a sufficient buffer for weather and other obstructions to observing.

Another important factor to consider is that bright bodies are much easier to identify during early twilight when the horizon is still sharp. Venus and Jupiter, when available, are among the brightest objects in the sky, so they should be among the first bodies chosen. The Moon is also easy to identify, but is not always a good target. It should be used when either the upper or lower limb is well defined (the Moon's "horns" are not parallel to the horizon) and the glint of moonlight on the sea surface is not bright enough to cause a problem in determining the location of the horizon.

A third consideration is to select bodies with an altitude greater than 15° to minimize systematic errors in refraction, and with an altitude less than 75° to prevent errors arising from the break down in the approximation that an *LOP* is equivalent to a circle of equal altitude. Select bodies that are at a similar altitude and of a similar brightness to further minimize systematic errors in taking sights

1813. Order of Observation

Take sights in a round-robin fashion, when possible. A number of individual observations of each body is desirable, but taking consecutive observations of different bodies helps assure that at least one observation is made of

each body in case there is a sudden change in the weather or the horizon becomes obscured. Taking non-consecutive sights of a body adds an element of randomness preventing systematic errors from creeping into the observations.

Brighter bodies are visible earlier during evening twilight and later during morning twilight. The Moon, Venus, and Jupiter can be observed before sunset or after sunrise, and the brightest stars can be observed during civil twilight. Sights of these objects made during these periods are more likely to have a well defined horizon, and allows more time for taking sights of dimmer stars and navigational planets

during nautical twilight. Making observations of the brighter bodies during civil twilight can be particularly helpful in the Torrid Zone (tropics) where the length of nautical twilight is less than half an hour.

During twilight, the horizon remains well defined near the azimuth of sunset or sunrise for a longer period of time than it does 180° away from that azimuth. Plan to take sights closer to that azimuth later during evening twilight and earlier during morning twilight. Precomputing the approximate azimuth of sunrise or sunset from the data in daily pages of the *Nautical Almanac* can aid in planning.

AIDS TO SIGHT PLANNING

1814. Aids to Sight Planning

There are a number of aids to help the navigator in sight planning:

The *Nautical Almanac* contains a planet location diagram on pp. 8 and 9, and star charts on pp. 266 and 267.

The *Air Almanac* contains a set of sky diagrams on pp. A26-A121. These diagrams show the altitudes and bearings of the Sun, Moon, navigational planets and stars at selected hours of the day, throughout the year, and for various latitudes. Each set includes diagrams for the North Pole and latitudes from 75° N to 50° S at an interval of 25°. A complete explanation of the sky diagrams is found on pages A24 and A25. The *Air Almanac* also includes a moonlight interference diagram on page A125 and star recognition diagrams for 40 (22 in the northern hemisphere and 18 in the southern hemisphere) of the 57 navigational stars on pp. A126-A129. Both sets of diagrams include instructions for their use.

STELLA (System To Estimate Latitude and Longitude Astronomically) is a software application for Windows computers that automates the sight reduction process. It includes a sight planning utility. STELLA also automatically logs all data entered for future reference. It is an allowance list requirement for U.S. Navy ships, and is also utilized by the U.S. Coast Guard. It is available for Navy or DoD components from the U.S. Naval Observatory.

MICA (Multiyear Interactive Computer Almanac) can, for a given location and time, compute the apparent altitude and azimuth of celestial bodies. It can compute the times and azimuths of rise and set and time and altitude of transit for a given location and date. For circumpolar bodies it computes the times and altitudes of both upper and lower transit. It can also compute the times of civil and nautical twilight. A catalog of the 57 navigational stars is included with MICA, and other catalogs can be added. MICA is produced by the Astronomical Applications Department of the

U.S. Naval Observatory. It is available from Willmann-Bell, <http://www.willbell.com>, for the general public, and from the U.S. Naval Observatory for Department of Defense Components.

The **Data Services** section of the USNO - Astronomical Applications Department **website** includes several calculators for use in sight planning (see Figure 1814a for the link):



Figure 1814a. USNO Data Services
<http://aa.usno.navy.mil/data/index.php>

1. The **Complete Sun and Moon Data for One Day** page computes the times and azimuths of rise, set for the Sun and Moon, and the times and altitudes of the transits and times of civil twilight.
2. The **Rise/Set/Transit Times for Major Solar System Bodies and Bright Stars** page computes the times and azimuths of rise, set and the times and altitudes of the transits for the Sun, Moon, planets and 22 of the navigational stars. .
3. The **Celestial Navigation Data for Assumed Position and Time** page computes the *Hc*, *Zn*, *GHA*, and *Dec* of the Sun, Moon, planets and navigational

stars. It also calculates the standard correction for refraction for all bodies and the corrections for the semi-diameter and parallax for the Sun, Moon, and planets. This service determines which bodies are available at a given time and place and color-codes the results for ease of use. See the Notes on the Data Services web page for details.

UK Rapid Sight Reduction Tables for Navigation NP 303 / AP/3270 (formerly Pub. 249 Vol. 1, Sight Reduction Tables for Air Navigation Vol I (Selected Stars)) provides a list of the seven navigational stars by LAT (latitude) and LHA. It also marks the three stars most appropriate for making a fix from stars well distributed on the sky. This publication has the advantage that it can be used in situations where electric power is not available and values of Hc and Zn can be determined swiftly near the epoch of the edition. Its main disadvantage is that values of Hc and Zn are sensitive to precession and can change by up to 0.8 per year. So, Hc and Zn must be interpolated for precession for

dates more than one or two years from the epoch of the edition used. (See the Correction for Precession and Nutation table in *Pub. NP 303/AP3270* for instructions on its use.) The correction table is designed only for observations made within an eight-year span (four years of the epoch of a particular edition), so a new edition of this volume is published every five years.

The ***RUDE 2102-D*** star finder is a device designed to estimate the approximate Hc and Zn of the 57 navigational stars given the observer's Lat and LHA of Aries. It can be used to find the positions of the planets and Moon as well with some additional effort. See Cutler, T.J. 2004, *Dutton's Nautical Navigation, Fifteenth Edition* (Annapolis, MD: Naval Institute Press) articles 2101-2105 for details of its description and use. The advantage of the star finder is that it can be used in situations where electric power is not available. Its principle disadvantage is it can take a while to use and interpret its data for a navigator not practiced in its use.

CHAPTER 19

SIGHT REDUCTION

BASIC PROCEDURES

1900. Computer Sight Reduction

The purely mathematical process of sight reduction is an ideal candidate for computerization, and a number of different hand-held calculators, apps, and computer programs have been developed to relieve the tedium of working out sights by tabular or mathematical methods. The civilian navigator can choose from a wide variety of hand-held calculators and computer programs that require only the entry of the DR position, measured altitude of the body, and the time of observation. Even knowing the name of the body is unnecessary because the computer can identify it based on the entered data. Calculators, apps, and computers can provide more accurate solutions than tabular and mathematical methods because they can be based on precise analytical computations rather than rounded values inherent in tabular data.

U.S. Navy and Coast Guard navigators have access to a U.S. Government program called **STELLA (System To Estimate Latitude and Longitude Astronomically)**; do not confuse with a similarly named commercial astronomy program). The Astronomical Applications Department of the U.S. Naval Observatory developed STELLA in response to a Navy requirement. The algorithms used in STELLA provide an accuracy of one arc-second on the Earth's surface, a distance of about 30 meters. While this accuracy is far better than can be obtained using a sextant, it does support possible naval needs for automated navigation systems based on celestial objects. These algorithms take into account the oblateness of the Earth, movement of the vessel during sight-taking, and other factors not fully addressed by traditional methods.

STELLA can perform almanac functions, position updating/DR estimations, celestial body rise/set/transit calculations, compass error calculations, sight planning, and sight reduction; on-line help and a user's guide are included. STELLA is now automatically distributed to each naval ship; other Navy users may obtain a copy by contacting:

Superintendent
U.S. Naval Observatory
Code: AA/STELLA
3450 Massachusetts Ave. NW
Washington, DC, 20392-5420

1901. Tabular Sight Reduction

The process of deriving from celestial observations the information needed for establishing a **line of position, LOP**, is called **sight reduction**. The observation itself consists of measuring the altitude of the celestial body above the visible horizon and noting the time.

This chapter concentrates on sight reduction using the *Nautical Almanac* and *Pub. No. 229: Sight Reduction Tables for Marine Navigation*. *Pub 229* is available on the NGA website. The method described here is one of many methods of reducing a sight. Use of the *Nautical Almanac* and *Pub. 229* provide the most precise sight reduction practical, 0.1' (or about 180 meters).

The *Nautical Almanac* contains a set of concise sight reduction tables and instruction on their use. It also contains methods and formulae for direct computation that may be used with a calculator or programmable computer.

The *Air Almanac* and NGA's *Pub. 249, Sight Reduction Tables for Air Navigation*, may also be used to reduce sights. Use of the *Nautical Almanac*'s concise reduction tables, the *Air Almanac*, and *Pub. 249* may all be used to reduce sights to a precision of 1'. The *Nautical Almanac*'s concise reduction tables allow sight reduction by providing all celestial data in a single publication.

Reducing a celestial sight to obtain a line of position consists of six steps:

1. Correct the **sextant altitude, H_s** , to obtain **observed altitude, H_o** , (sometimes called true altitude).
2. Determine the body's **Greenwich Hour Angle, GHA** and **declination, Dec** .
3. Select an **assumed position, AP** and find its **Local Hour Angle, LHA** .
4. Compute **altitude, H_c** and **azimuth, Z_n** , for the AP .
5. Compare the H_c and H_o .
6. Plot the **line of position, LOP** .

The introduction to each volume of *Pub. 229* contains information discussing:

1. The use of the publication for a variety of special celestial navigation techniques;
2. Interpolation.:

- a. Explaining the second difference interpolation required in some sight reductions;
 - b. Providing tables to facilitate the interpolation process; and,
3. The publication's use in solving problems of great circle sailings.

Prior to using *Pub. 229*, carefully read this introductory material.

The goal of celestial navigation is to determine the navigator's position from the intersection of two or more *LOPs* from observations of the altitudes of one or more celestial bodies and their **geographic positions, GP**, at the time of observation. The *GP* is the point on the Earth's surface that intersects the line from a celestial body to the Earth's center. In other words, at the *GP*, the celestial body is directly overhead. The locus of points on the Earth's surface where a body appears at a constant altitude forms a circle centered on the *GP*. So, when navigators observe the altitude of a body, they are determining the circle of constant altitude on which they are located. Except when a body's *Ho* approaches 90°, the portion of the circle of constant altitude plotted on a chart can be approximated by a line called the *LOP*. Assuming the *AP* is within 30' of the true position, the maximum error accrued from estimating the circle of constant altitude with an *LOP* is 3/8 mile for an *Ho* of 70° and 3/4 mile for an *Ho* of 80°.

In sight reduction, navigators choose an assumed position, *AP*, near, but usually not coincident with, their *DR* position. The *AP*'s latitude and longitude are chosen to correspond with the Local Hour Angle, *LHA*, and latitude which are entering arguments of the sight reduction tables in *Pub. 229*. From *Pub. 229*, the navigator determines the body's *Hc*, its computed altitude, and its true azimuth, *Zn*, at the *AP* at the time of observation. The difference between *Hc* and *Ho* is the **altitude intercept, a**. The value of *a*, in minutes of arc, is equal to the distance, in nautical miles, between the circle of equal altitude on which the *AP* is located and the one from which the body was observed.

The values of *a* and *Zn* are used to plot an *LOP*. First, the *AP* is plotted on the chart or plotting sheet. A line is drawn through *AP* at the angle *Zn* with respect to true North. The *LOP* is drawn perpendicular to this line. If *Ho* is greater than *Hc*, then the *LOP* is plotted in nautical miles from the *AP* in the direction of *Zn*. If *Ho* is less than *Hc*, then the *LOP* is plotted in nautical miles from the *AP* in the direction away from *Zn*.

1902. Selection of the Assumed Position (AP)

As mentioned above, the *AP* is chosen so the navigator can use the tabular values of a publication minimizing the need to interpolate. Thus, the *AP* is typically not your *DR*, and it is different for each object observed, even if the ship is stationary. The *AP* latitude is chosen to be the nearest whole degree in latitude to the *DR* latitude. The *AP*

longitude is that nearest the *DR* longitude resulting in a whole degree of *LHA* for the observed body. The tabular interval in the sight reduction tables of *Pub. 229* for both latitude and *LHA* is one degree. Selecting the *AP* in this manner eliminates interpolation in *LHA* and latitude.

1903. Comparison of Computed and Observed Altitudes

The **altitude intercept** (sometimes just called **intercept**), *a*, is the difference between the radii of the circles of equal altitude passing through the *AP* and the observer's true position. The position with the greater altitude is on the circle of smaller radius and closer to the observed body's *GP*. In Figure 1904, the *AP* is shown on the inner circle. Therefore, *Hc* is greater than *Ho*. One minute of arc is equal to one nautical mile. Therefore, *a* is expressed in nautical miles toward, *T*, or away, *A*, from the *GP*, as measured from the *AP*. If *Ho* is greater than *Hc*, the *LOP* intersects at right angles the line drawn from the *AP* Towards the *GP* at a distance of *a* miles. If *Hc* is greater than *Ho*, the line of position intersects at right angles the line drawn from the *AP* Away from the *GP* at a distance of *a* miles. Useful mnemonics for remembering the relation between *Ho*, *Hc*, and *a* are: **HoMoTo** for *Ho More Towards*, and **C-G-A** or *Coast Guard Academy* for Computed Greater Away.

1904. Plotting a Line of Position (LOP) and Fixing the Position

Plotting an *LOP* is done in four steps:

1. Plot the *AP*.
2. Draw a light dashed line at true azimuth *Zn* through the *AP*.
3. Measure *a* along this line.
4. Draw a line perpendicular to the azimuth line through this point.

This line is the *LOP*, which represents that segment of the circle of equal altitude passing through the navigator's true position. See Figure 1904. The navigator's true position is somewhere along this line, but with only one sight performed, we do not know where.

A celestial navigation **fix** is the place where two or more *LOPs* intersect. When three or more *LOPs* are used to make a fix, they will usually not all intersect at the same point due to limitations in the precision of the observations. Instead, they will form a 'cocked hat.' A fix may be obtained from plotting the *LOPs* of multiple objects observed at approximately the same epoch (time) or from plotting the *LOPs* of observations of one or more objects made at multiple epochs.

The position of the vessel will have changed significantly between the first and last observations for a fix from

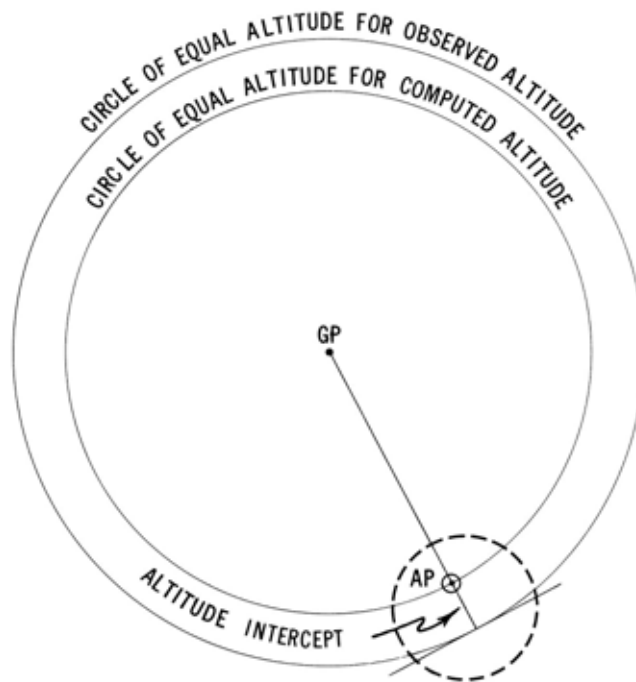

Figure 1904. The basis for the line of position from a celestial observation.

observations made at multiple epochs. This type of fix is referred to as a **running fix**. To determine the ship's position at a particular epoch, *LOPs* from earlier epochs must be advanced along the *DR* track and *LOPs* from later epochs must be retarded along the *DR* track. To advance or retard an *LOP*:

1. Draw a light line segment from the *AP* at the epoch of observation so that it intersects the *LOP* at right angles.
2. Measure this line segment's *Zn* and length.
3. At the *AP* of the common epoch, draw a light line segment of the same length and at the same *Zn*.
4. At the non-*AP* end of this second line segment, draw a line perpendicular to it.

This new line is the advanced or retired *LOP*. A running fix is not as accurate as a fix made from observations made at about the same epoch due to accumulated errors from sources such as steering errors and currents.

If a running fix is made from multiple observations of the same body, then enough time between the observations should be allowed to elapse so that the *Zn* of the body has precessed by at least 30° . A change in *Zn* is required to determine where two *LOPs* cross. A difference of 90° is ideal, but a variance of 30° is adequate to provide a good fix.

1905. Sight Reduction Procedures

It is important to develop a practical procedure to

reduce celestial sights consistently and accurately. Sight reduction involves several steps. An accurate sight reduction requires that each step be concisely and accurately performed. Sight reduction tables reduce the mathematics involved as much as possible to addition and subtraction. Careless errors, however, can render the *LOP* deduced from even the most skillfully measured sights inaccurate. The navigator must work methodically to avoid errors.

Naval navigators will most likely use OPNAV 3530/1, *U.S. Navy Navigation Workbook*, which contains "strip forms" to aid in the reduction of sights using either *NGA Pub. 229* or *Pub.249* with either the *Nautical Almanac* or the *Air Almanac*. OPNAV 3530/1 also contains strip forms to aid in determining ship's latitude by *Polaris* and the local times of sunrise, sunset, moonrise, and moonset using data from either the *Nautical Almanac* or the *Air Almanac*. The *Nautical Almanac* includes a strip form designed specifically for use with its concise sight reduction tables. Use of other strip forms is authorized with the proviso that **they become an official part of the record** for the workbook being used.

Figure 1905 is a reproduction of the OPNAV 3530/1 strip form for sight reduction using the *Nautical Almanac* and *Pub. 229*. Working from top to bottom the entries are:

Date: The UT date of the sight.

Body: The name of the body whose altitude was measured. Indicate whether the upper or lower limb was measured if the body was the Sun or the Moon.

GMT (Greenwich Mean Time): The UT (GMT is an

OPNAV 353040 (4-73) H.O. 229 NAUT ALM		NAVIGATION WORKBOOK OPNAV 353071 (Rev. 8-01)	
Date	DATE/DR POSIT		
Body			
GMT			
IC			
D			
Sum			
hs			
ha			
Alt Corr			
Add'l Corr Moon HP/Corr			
Ho			
GHA (h)			
Incre (m/s)			
v/v Corr SHA			
Total GHA			
$\pm 360^\circ$			
aλ (+E, -W)			
LHA			
Tab Dec			
d# / d cor			
True Dec			
a LAT Same Contrary			
Dec Inc / d			
Tens / DSD			
Units / DSD Corr			
Total Corr			
Hc (Tab)			
Hc (Comp)			
Ho			
a			
Z			
Zn			
Fix Lat			
Long			
Fix Time			
Sounding			
Signature			

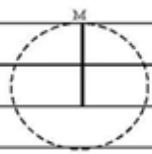

Figure 1905. Sight reduction strip form for use with the *Nautical Almanac* and Pub 229.

outdated name for UT) of the observation. The UT is the *Watch Time* of the observations adjusted for the *Watch Correction* and *Zone Description* (see Chapter 20).

IC (Index Correction): The instrumental correction for the sextant used. Chapter 18 discusses determining its magnitude and sign.

D (Dip): Dip correction is a function of the height of eye of the observer and atmospheric refraction. Its magnitude is determined from the Dip Table on the inside front cover of the *Nautical Almanac*.

Sum: The sum of *IC* and *D*.

Hs (Sextant Altitude): The altitude of the body measured by the sextant.

Ha (Apparent Altitude): The sum of *Hs* and the *IC* and *D* corrections.

Alt. (Altitude) Correction: Every observation requires an altitude correction. This correction is a function of the apparent altitude of the body. The *Nautical Almanac* contains tables for determining these corrections. The tables for the Sun, planets, and stars are located on the inside front cover and facing page, pages A2 and A3. The tables for the Moon are located on the back inside cover and preceding page, pages xxxiv and xxxv.

These tables are based on observations taken under “standard” weather conditions; that is, temperatures near 50° F and air pressures near 1010mb. If observations are taken in conditions that deviate much from this, an additional altitude correction is needed; see the *Nautical Almanac* table on page A4.

Note that the correction found on A4 is to be applied in addition to the corrections found on pages A2, A3, xxxiv or xxxv.

Add'l Corr/Moon HP Corr.: An additional correction is required for sights of Mars, Venus and the Moon. It adjusts for the phase and parallax of these bodies. The correction is a function of the body observed, the epoch of observation, and *Ha*. The corrections for Venus and Mars are listed inside front cover of the *Nautical Almanac*. These corrections change from year to year. The correction for the Moon is a function of the Moon's *Ha*, its *HP*, and whether the upper, *U*, or lower, *L*, limb was observed. The tables for this correction are located inside the back cover and on the preceding page. Enter the table at the appropriate values for *Ha* and *HP*, and then choose the value associated with the *L* or *U* column as appropriate. If the upper limb was observed subtract 30', as well.

Ho (Observed Altitude): Add together *Ha*, the Altitude Correction, and the Additional Correction or Moon *HP* Correction, as appropriate. The result is the observed altitude, *Ho*.

GHA (Tabulated GHA): The tabulated value for the whole hour immediately preceding the time of the sight observation. For the Sun, the Moon, or a planet, extract the tabulated value for the Greenwich Hour Angle, GHA, of that body from the daily pages of the *Nautical Almanac*. For example, if the sight was obtained at 13^h50^m45^s UT, extract the GHA value for 13^h. For a star sight reduction, extract the tabulated value of the GHA of

Aries Υ .

Incr: The GHA increment is an interpolation factor, correcting for the time that the sight differed from the whole hour. For example, if the sight was obtained at 13^h50^m45^s UT, this increment correction accounts for the 50 minutes and 45 seconds after 13^h. The increment value is tabulated in the Increments and Corrections tables on pages ii through xxxi in the *Nautical Almanac*. The entering arguments are the minutes and seconds after the hour. Select the correction from the appropriate column. Use the column labeled *Aries* for sights of stars.

ν / ν Corr. / SHA: The true rate of motion in hour angle for the Moon and planets usually varies from the mean motion used to determine the increments. The parameter ν is the difference between the mean and true motion in arc minutes per hour. The change in hour angle arising from ν of the body at the time of the sight observation is accounted for with the ν correction. The value of ν for a planet sight is found at the bottom of the planet's column in the daily pages of the *Nautical Almanac*. The value of ν for the Moon is located directly beside the tabulated hourly GHA values in the daily pages of the *Nautical Almanac*. A body's ν is positive unless it is listed with a negative sign. Enter the value for ν on the left-hand side of the strip form. The ν correction is found using the Increments and Correction tables on pages ii through xxxi in the back of the *Nautical Almanac*. Enter the table using the minutes of the time of observation. Find the value in the " ν or d " columns corresponding to the value of ν for the time of observation. Enter the corresponding correction on the right-hand side of the strip form with the same sign as ν .

The Sidereal Hour Angle (*SHA*) is the difference between the GHA of a star and the GHA of Aries. The SHA of a star changes slowly. The SHA's of the 57 navigational stars are listed, in alphabetical order of the stars names, in the star column of the daily pages of the *Nautical Almanac*. The mean monthly SHA's of 173 stars, including the 57 navigational stars, are listed in order of SHA on pages 268 through 273 of the *Nautical Almanac*. Enter the SHA in place of the ν correction in the strip form if reducing a star sight.

Total GHA: The total GHA is the sum of the tabulated GHA, the GHA increment, and either the ν correction or the star's SHA.

$\pm 360^\circ$: Since the LHA will be determined from subtracting or adding the assumed longitude to the GHA, adjust the GHA by 360° if needed to facilitate the addition or subtraction.

Rule of Thumb:

- In East Longitudes, $LHA = GHA + \text{Longitude}(-360^\circ$ as necessary)
- In West Longitudes, $LHA = GHA - \text{Longitude}(+360^\circ$ as necessary)

Example: For a longitude of 90° East and GHA of 300°

$$LHA = GHA + \text{Longitude} - 360^\circ (300^\circ + 90^\circ = 390^\circ - 360^\circ = 30^\circ).$$

$a \lambda$ (Assumed Longitude): Choose an assumed longitude, $a \lambda$. If the vessel is west of the prime meridian, $LHA = GHA - a \lambda$, where LHA is the Local Hour Angle. If the vessel is east of the prime meridian, $LHA = GHA + a \lambda$. The $a \lambda$ is chosen so that it is the longitude closest to that DR longitude where the LHA is a whole degree.

LHA (Local Hour Angle): The LHA is the hour angle of the observed body at a λ . The LHA is $GHA - a \lambda$, for west longitudes and $GHA + a \lambda$ for east longitudes. Note that this should be a whole degree, else you have chosen the $a \lambda$ incorrectly.

Tab. Dec.: Obtain the tabulated declination for the Sun, Moon, stars, or planets from the daily pages of the *Nautical Almanac*. The declination values for the Sun, Moon, and planets are listed in hourly increments. Enter the declination value for the whole hour immediately preceding the sight for these bodies. For example, if the sight is at 12^h58^m40^s, enter the tabulated declination for 12^h. The declinations of the 57 navigational stars are listed, in alphabetical order of the stars names, in the star column of the daily pages of the *Nautical Almanac*. The mean monthly declinations of 173 stars, including the 57 navigational stars, are listed in order of SHA on pages 268 through 273 of the *Nautical Almanac*.

d / d Corr.: The declinations of the Sun, Moon, and planets change with time. The parameter d is the amount of change in declination in arc minutes per hour. The change in declination of the body at the time of the sight observation is accounted for with the d correction. The value of d for a planet sight is found at the bottom of the planet's column in the daily pages of the *Nautical Almanac*. The value of d for the Moon is located directly beside the tabulated hourly declination values in the daily pages of the *Nautical Almanac*. Enter the value for d on the left-hand side of the strip form. The sign of the d correction is determined by the trend of declination value. For example, for a sight taken at 12^h30^m00^s. Compare the declination values for 12^h and 13^h and determine if the declination value has increased or decreased. If it has increased, the d correction is positive, and if it has decreased, the d correction is negative. The magnitude of the d correction is found using the Increments and Correction tables on pages ii through xxxi in the *Nautical Almanac*. Enter the table using the minutes of the time of observation. Find the value in the " ν or d " columns corresponding to the value of d for the time of observation. Enter the corresponding correction on the right-hand side of the strip form. The rate of change in declination of the stars is so small that their sights do not require a d correction.

True Dec.: The sum of the tabulated declination and the d correction is the true declination.

$aLAT$ (Assumed Latitude): Choose the whole degree of latitude closest to the vessel's DR latitude as the assumed latitude, $aLAT$. If the assumed latitude and declination are both north or both south, label the assumed latitude *Same*. If one is north and the other is south, label the assumed latitude *Contrary*.

DateDecl. inc. / d : Two of the three arguments used to enter the main table of *Pub. 229*, LHA and $aLAT$, are whole degree values. The third argument, declination, is interpolated in *Pub. 229*. The method for interpolating declination is described on pages X-XIV of each volume of *Pub. 229*. The interpolation tables are located on the inside of the front cover and following page and inside of the back cover and preceding page of each volume of *Pub. 229*.

Interpolation is done using the declination increment, d . (This d is not the same as the d factor in the *Nautical Almanac*.) From the main table of *Pub. 229* extract the value of d for the tabular declination value preceding the body's declination. For example, if the body's declination is $30^{\circ} 35.1'$, then record the tabular values in the row for Dec. = 30° . If the value for d is printed in italics and followed by a dot, then second-difference interpolation is required to maintain precision. In this case record the preceding and following entries for the value of d as well. For example, for LHA = 28° , $aLat = 15^{\circ}$ Same, Dec. = 16° , the entry for d is $+0.8 \bullet$. The preceding entry is $+2.8 \bullet$, and the following entry is $-1.3 \bullet$. Record all three entries, in order.

Tens / DSD: If d is greater than $10'$, then extract the interpolated value for the tens of d from the interpolation tables in *Pub. 229*. Refer to the description for use of the interpolation tables on pages XI-XII of any volume of *Pub. 229* for details.

Units / DSD Corr: Extract the interpolated value for the units of d from the interpolation tables in *Pub. 229*. Refer to the description for use of the interpolation tables on pages XI-XII of any volume of *Pub. 229* for details. If a second difference correction is required: subtract the value of the following entry for d from the preceding value. For example, if the preceding entry is $+2.8$, and the following entry is -1.3 , then the result is $2.8 - (-1.3) = 4.1$. Use this value to enter in the appropriate part of the second difference portion of the interpolation table in *Pub. 229*. Refer to the description for the use of the second difference interpolation on page XIV of any volume of *Pub. 229* for details. Add the second difference correction to the units correction before entering it in the strip form. *Failure to include the second difference correction may result in an error of as much as 2.1 in the final value of H_c .*

Total Corr.: The sum of the tens and units corrections

is the total correction.

H_c (Tab.): The tabulated value of H_c from the same entry in *Pub. 229* from which d was extracted.

H_c (Comp.): The sum of H_c (Tab.) and the total corrections is H_c (Comp.).

H_o : The observed altitude calculated above.

a (Altitude Intercept): The absolute value of the difference between H_c and H_o is the altitude intercept, a . If H_o is greater than H_c , then label a as *Toward*. If H_c is greater than H_o , then label a as *Away*. Remember, "computed greater away."

Z (Azimuth Angle): The tabulated value of the azimuth angle, Z , is extracted from the same entry in *Pub. 229* from which H_c and d were extracted. Interpolation is not required.

Z_n (True Azimuth): The azimuth, Z , is the angular distance between the direction towards the observed body and the direction towards the elevated pole. The true azimuth, Z_n , is the angular distance measured eastward from the direction towards the North Pole to the direction towards the observed body. The value of Z_n is a function of Z , LHA, and whether the observer is located north or south of the equator.

In northern latitudes:

$$Z_n = \begin{cases} Z & \text{LHA} > 180^{\circ} \\ 360^{\circ} - Z & \text{LHA} < 180^{\circ} \end{cases}$$

In southern latitudes:

$$Z_n = \begin{cases} 180^{\circ} - Z & \text{LHA} > 180^{\circ} \\ 180^{\circ} + Z & \text{LHA} < 180^{\circ} \end{cases}$$

Fix., Lat., Long., Time: Enter the point of intersection and time when two or more *LOPs* are plotted to determine a fix. The time of the fix is not necessarily the time of the sight because *LOPs* may be advanced or retired. The diagram may be used to sketch the Z_n 's and a 's used to determine the fix.

Sounding: If a sounding is available its value may be entered here.

Signature: The sight reduction is a part of the ship's official record and must be signed by the navigator.

SIGHT REDUCTION

The section above discussed the basic theory of sight reduction and presented a method to be followed when reducing sights. This section puts that method into practice in reducing sights of a star, the Sun, the Moon, and planets.

1906. Reducing Star Sights to a Fix

In this section, we will reduce three star sights using the *Nautical Almanac* and *Pub 229*. The first of the three

sights will be reduced in step-by-step detail; the remaining two will not, since the technique is exactly the same. A strip form is utilized to aid in the reduction. A completed strip form showing the values from the three examples presented is shown in Figure 1906a.

On March 09, 2016, at the times indicated, the navigator takes and records the following sights (see the three column table with sextant altitude and *zone time* for Deneb, Antares and Alkaid):

OPNAV 3530/40 (4-75) H.O. 229 NAUT ALM		NAVIGATION WORKBOOK OPNAV 3530/1 (Rev. 7-74)		
Date	DATE/DR POSIT 9 Mar 2016 39° N 045° 26.0' W	DATE/DR POSIT 9 Mar 2016 39° N 045° 26.0' W	DATE/DR POSIT 9 Mar 2016 39° N 045° 26.0' W	DATE/DR POSIT
Body	Deneb	Antares	Alkaid	
GMT	08-58-27	09-02-14	09-06-32	
IC	+0.2'	+0.2'	+0.2'	
D	-8.0'	-8.0'	-8.0'	
Sum	-7.8'	-7.8'	-7.8'	
hs	50° 34.4'	23° 57.2'	52° 33.9'	
ha	50° 26.6'	23° 49.4'	52° 26.1'	
Alt Corr	-0.8'	-2.2'	-0.7'	
Add'l Corr Moon HP/Corr	—	—	—	
Ho	50° 25.8'	23° 47.2'	52° 25.4'	
GHA (h)	287° 26.6'	302° 29.1'	302° 29.1'	
Incr (m/s)	14° 39.2'	33.6'	1° 38.3'	
v/v Corr SHA	49° 30.5'	112° 23.9'	152° 57.1'	
Total GHA	351° 36.3'	415° 26.6'	457° 4.5'	
+ 360°	—	055° 26.6'	097° 4.5'	
aλ (+E, -W)	045° 36.3' W	045° 26.6' W	045° 4.5' W	
LHA	306°	10°	52°	
Tab Dec	N 45° 20.2'	S 26° 27.8'	N 49° 13.8'	
d# / d cor	—	—	—	
True Dec	N 45° 20.2'	S 26° 27.8'	N 49° 13.8'	
a LAT Same Contrary	N 39° same	N 39° cont	N 39° same	
Dec Inc / d	20.2' / +10.8'	27.8' / -59.4'	13.8' / + 4.4'	
Tens / DSD	—	—	—	
Units / DSD Corr	—	—	—	
Total Corr	+3.6'	-27.5'	+1.0'	
Hc (Tab)	50° 10.5'	24° 19.9'	52° 04.7'	
Hc (Comp)	50° 14.1'	23° 52.4'	52° 05.7'	
Ho	50° 25.8'	23° 47.2'	52° 25.4'	
a	11.7' toward	5.2' away	19.7' toward	
Z	63.3°	170.1°	57.3°	
Zn	63.3°	189.9°	302.7°	
Fix Lat				
Long				
Fix Time				
Sounding				
Signature				USN NAVIGATOR

Figure 1906a. Strip form for sight reduction of stars.

Height of eye is 68 feet and index correction (IC) is +0.2'. The DR latitude for all sights is 39° N. The DR longitude for all sights is 045° 26.0'W. See Figure 1906b. Reduce the Deneb sight first.

Start by converting the sextant altitudes to the observed altitudes.

Determine the sum of the index correction and the dip correction. Go to the inside front cover of the *Nautical Almanac* to the table entitled "DIP." See Figure 1906c. This table lists dip corrections as a function of height of eye measured in either feet or meters. The dip table is a "critical table"; that is it is evaluated in intervals. To use it, find the interval of height of eye and read the corresponding correction. In the above problem, the observer's height of eye is 68 feet, which lies between the tabulated values of 67.1 to 68.8 feet; the corresponding correction for this interval is -8.0'. Add the IC and the dip correction, being careful to carry the correct sign. The sum of the corrections here is -7.8'. Apply this correction to the sextant altitude (h_s) to obtain the apparent altitude (h_a) of 50° 26.6'.

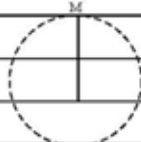
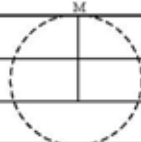
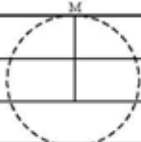
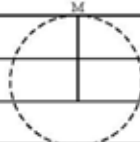
Next, apply the altitude correction. Find the altitude correction table on the inside front cover of the *Nautical Almanac* next to the dip table. See Figure 1906c. This is also a critical table. The altitude correction varies as a function of both the type of body sighted (Sun, star, or planet) and the body's apparent altitude. For the problem above, enter the star altitude correction table; h_a in this case was 50° 26.6'. This value lies between the tabulated endpoints 48° 45.0' and 52° 16.0'. The correction corresponding to this interval is -0.8'. Applying this correction to h_a yields an observed altitude of 50° 25.8'.

Having calculated the observed altitude, *determine the time and date of the sight in UTI (Universal Time) or GMT (Greenwich Mean Time):* **Date** = 09 March 2016, **DR Latitude** = 39° N, **DR Longitude** = 045° 26.0' W, **Observation Time** = 05-58-27, **Watch Error** = 0, **Zone Time** = +3, **GMT** = 08-58-27, and **GMT Date** = 09 March 2016.

Record the observation time and then apply any watch error to determine zone time. Then, use the DR longitude at the time of the sight to determine time zone description. In this case, the DR longitude indicates a zone description of +3 hours. Add the zone description to the zone time to obtain UT/GMT. It is important to carry the correct date when applying this correction (Note: this step, other than recording the DR, UT/GMT, and UT/GMT date, is not on the example strip form (Figure 1906a).

After calculating both the observed altitude and the UT/GMT time, calculate the star's Greenwich Hour Angle (GHA) and declination using the daily pages of the *Nautical Almanac*.

First, record the GHA of Aries from the March 09, 2016 daily page: 287° 26.6'.

Next, determine the incremental addition for the minutes and seconds after 0800 from the Increments and Corrections table in the back of the *Nautical Almanac*. The increment for 58 minutes and 27 seconds is 14° 39.2'.

Then, calculate the GHA of the star. Remember:

$$\text{GHA (star)} = \text{GHA } \Upsilon + \text{SHA (star)}$$

The *Nautical Almanac* lists the SHA of selected stars on each daily page. The SHA of Deneb on March 09, 2016: 49° 30.5'. The Total GHA is 287° 26.6' + 14° 39.2' + 49° 30.5' = 351° 36.3'. If this were 360° or larger, then subtract 360°.

Initially you must choose an assumed longitude, $a\lambda$, rather than using the ship's actual longitude. This is done because one of *Pub 229*'s entering arguments is in whole degrees of LHA of the observed body. In order to get a whole degree of LHA, we will have to slightly change our DR longitude to a new, assumed longitude, $a\lambda$. The $a\lambda$ is chosen so that it is the longitude closest to that DR longitude where the LHA is a whole degree. Remember that if the vessel is west of the prime meridian, $\text{LHA} = \text{GHA} - a\lambda$, and if the vessel is east of the prime meridian, $\text{LHA} = \text{GHA} + a\lambda$. In this example the vessel is in west longitude, so subtract its assumed longitude from the GHA of the body to obtain the LHA. The assumed longitude must end in 36.3', so that when subtracted from the Total GHA, a whole degree of LHA will result. Since the DR longitude was 045° 26.0', the assumed longitude ending in 36.3' closest to the DR longitude is 045° 36.3'. Subtracting this assumed longitude from the calculated GHA of the star yields an LHA of 306°.

The next value of concern is the star's true declination. This value is found on the March 09 daily page next to the star's SHA (see Figure 1906b). Deneb's declination is N 45° 20.2'. There is no d correction for a star sight, so the star's true declination equals its tabulated declination.

The assumed latitude is determined from the whole degree of latitude closest to the DR latitude at the time of the sight. In this case, the assumed latitude is N 39°. It is marked "same" because both DR latitude and star's declination are north.

In order to find an object's altitude and azimuth using *Pub 229*, we need the ship's assumed latitude, the object's LHA, and its declination. We have this information for our example sight of Deneb. To recap, we have: the ship's assumed longitude (045° 36.3' W) and assumed latitude (39° N same); Deneb's LHA at $a\lambda$ (306°); and Deneb's declination (N 45° 20.2'). We are now ready to use *Pub 229* to find Deneb's altitude and azimuth.

Find the page in the Sight Reduction Table (using *Pub 229*, for our example) corresponding to an LHA of 306° and an assumed latitude of N 39°, with latitude same to declination. Enter this table with the body's whole degree of declination. In this case, the body's whole degree of declination is 45°. This declination corresponds to a tabulated altitude (h_c Tab) of 50° 10.5'. This value is for a declination of 45°; the true declination is 45° 20.2'. Therefore, we need to interpolate to this increment (20.2') to obtain the computed altitude.

2016 MARCH 7, 8, 9 (MON., TUES., WED.)

UT	ARIES			VENUS -3.8			MARS +0.1			JUPITER -2.5			SATURN +0.5			STARS		
	GHA	GHA	Dec	GHA	Dec		GHA	Dec		GHA	Dec	GHA	Dec		Name	SHA	Dec	
MONDAY	00	165 08.6	199 13.8	S14 36.2	286 42.1	S18 58.9	355 08.6	N 5 54.3		270 01.4	S21 00.2				Acamar	315 17.2	S40 14.8	
	01	180 11.1	214 13.2	35.2	301 43.6	59.1	10 11.3	54.5		285 03.8	00.2				Achernar	335 26.0	S57 09.6	
	02	195 13.5	229 12.6	34.3	316 45.1	59.3	25 14.1	54.6		300 06.2	00.2				Acruz	173 06.4	S63 11.3	
	03	210 16.0	244 12.0	33.4	331 46.7	59.6	40 16.8	54.7		315 08.6	00.2				Adhara	255 10.9	S29 00.1	
	04	225 18.5	259 11.4	32.4	346 48.2	59.8	55 19.6	54.9		330 11.0	00.2				Aldebaran	290 47.3	N16 32.3	
	05	240 20.9	274 10.8	31.5	1 49.7	19 00.0	70 22.4	55.0		345 13.3	00.2							
	06	255 23.4	289 10.3	S14 30.5	16 51.3	S19 00.2	85 25.1	N 5 55.1		0 15.7	S21 00.2				Alioth	166 18.7	N55 52.2	
	07	270 25.8	304 09.7	29.6	31 52.8	00.4	100 27.9	55.3		15 18.1	00.2				Alkaid	152 57.1	N49 13.8	
	08	285 28.3	319 09.1	28.7	46 54.3	00.6	115 30.7	55.4		30 20.5	00.2				Al Na'ir	27 41.9	S46 52.9	
	09	300 30.8	334 08.5	27.7	61 55.9	00.8	130 33.4	55.5		45 22.9	00.2				Alnilam	275 44.5	S 1 11.8	
	10	315 33.2	349 07.9	26.8	76 57.4	01.0	145 36.2	55.7		60 25.3	00.3				Alphard	217 54.0	S 8 44.0	
	11	330 35.7	4 07.4	25.8	91 58.9	01.3	160 39.0	55.8		75 27.6	00.3							
	12	345 38.2	19 06.8	S14 24.9	107 00.5	S19 01.5	175 41.7	N 5 55.9		90 30.0	S21 00.3				Alphecca	126 09.3	N26 39.5	
	13	0 40.6	34 06.2	23.9	122 02.0	01.7	190 44.5	56.0		105 32.4	00.3				Alpheratz	357 41.9	N29 10.7	
	14	15 43.1	49 05.6	23.0	137 03.5	01.9	205 47.3	56.2		120 34.8	00.3				Alfair	62 06.6	N 8 54.7	
	15	30 45.6	64 05.1	22.0	152 05.1	02.1	220 50.0	56.3		135 37.2	00.3				Arkaa	353 14.3	S42 13.3	
	16	45 48.0	79 04.5	21.1	167 06.6	02.3	235 52.8	56.4		150 39.6	00.3				Antares	112 23.9	S26 27.8	
	17	60 50.5	94 03.9	20.2	182 08.2	02.5	250 55.6	56.6		165 41.9	00.3							
	18	75 53.0	109 03.3	S14 19.2	197 09.7	S19 02.7	265 58.3	N 5 56.7		180 44.3	S21 00.3				Arcturus	145 53.8	N19 05.8	
	19	90 55.4	124 02.7	18.3	212 11.2	03.0	281 01.1	56.8		195 46.7	00.3				Atria	107 24.0	S69 02.9	
	20	105 57.9	139 02.2	17.3	227 12.8	03.2	296 03.8	57.0		210 49.1	00.3				Avior	234 16.7	S59 34.1	
	21	121 00.3	154 01.6	16.4	242 14.3	03.4	311 06.6	57.1		225 51.5	00.3				Bellatrix	278 30.0	N 6 21.5	
	22	136 02.8	169 01.0	15.4	257 15.8	03.6	326 09.4	57.2		240 53.9	00.3				Belgeseuse	270 59.2	N 7 24.3	
23	151 05.3	184 00.5	14.4	272 17.4	03.8	341 12.1	57.3		255 56.3	00.3								
TUESDAY	00	166 07.7	198 59.9	S14 13.5	287 18.9	S19 04.0	356 14.9	N 5 57.5		270 58.6	S21 00.3			Canopus	263 55.1	S52 42.8		
	01	181 10.2	213 59.3	12.5	302 20.5	04.2	11 17.7	57.6		286 01.0	00.3			Capella	280 31.7	N46 00.8		
	02	196 12.7	228 58.7	11.6	317 22.0	04.4	26 20.4	57.7		301 03.4	00.3			Deneb	49 30.5	N45 20.2		
	03	211 15.1	243 58.2	10.6	332 23.6	04.6	41 23.2	57.9		316 05.8	00.3			Denebola	182 31.5	N14 28.8		
	04	226 17.6	258 57.6	09.7	347 25.1	04.8	56 26.0	58.0		331 08.2	00.3			Diphda	348 54.4	S17 54.1		
	05	241 20.1	273 57.0	08.7	2 26.7	05.1	71 28.7	58.1		346 10.6	00.3							
	06	256 22.5	288 56.5	S14 07.8	17 28.2	S19 05.3	86 31.5	N 5 58.3		1 13.0	S21 00.3				Dubhe	193 48.9	N61 39.7	
	07	271 25.0	303 55.9	06.8	32 29.7	05.5	101 34.3	58.4		16 15.4	00.3				El Nath	278 10.2	N28 37.1	
	08	286 27.5	318 55.3	05.9	47 31.3	05.7	116 37.0	58.5		31 17.7	00.3				Elfanin	90 45.4	N51 29.1	
	09	301 29.9	333 54.7	04.9	62 32.8	05.9	131 39.8	58.6		46 20.1	00.3				Enif	33 45.6	N 9 56.9	
	10	316 32.4	348 54.2	03.9	77 34.4	06.1	146 42.6	58.8		61 22.5	00.3				Fomalhaut	15 22.3	S29 32.3	
	11	331 34.8	3 53.6	03.0	92 35.9	06.3	161 45.3	58.9		76 24.9	00.3							
	12	346 37.3	18 53.0	S14 02.0	107 37.5	S19 06.5	176 48.1	N 5 59.0		91 27.3	S21 00.3				Gacrux	171 58.2	S57 12.2	
	13	1 39.8	33 52.5	01.1	122 39.0	06.7	191 50.9	59.2		106 29.7	00.3				Genah	175 50.1	S17 38.0	
	14	16 42.2	48 51.9	14 00.1	137 40.6	06.9	206 53.6	59.3		121 32.1	00.3				Hadar	148 44.7	S60 26.8	
	15	31 44.7	63 51.3	13 59.1	152 42.1	07.1	221 56.4	59.4		136 34.5	00.3				Hamal	327 58.9	N23 32.2	
	16	46 47.2	78 50.8	58.2	167 43.7	07.4	236 59.2	59.5		151 36.9	00.3				Kaus Aust.	83 41.5	S34 22.3	
	17	61 49.6	93 50.2	57.2	182 45.2	07.6	252 01.9	59.7		166 39.2	00.3							
	18	76 52.1	108 49.6	S13 56.2	197 46.8	S19 07.8	267 04.7	N 5 59.8		181 41.6	S21 00.3				Kochab	137 19.6	N74 05.2	
	19	91 54.6	123 49.1	55.3	212 48.3	08.0	282 07.4	5 59.9		196 44.0	00.3				Markab	13 36.8	N15 17.5	
	20	106 57.0	138 48.5	54.3	227 49.9	08.2	297 10.2	6 00.1		211 46.4	00.3				Merkar	314 13.3	N 4 08.9	
	21	121 59.5	153 47.9	53.3	242 51.4	08.4	312 13.0	00.2		226 48.8	00.3				Merkont	148 05.1	S36 26.8	
	22	137 01.9	168 47.4	52.4	257 53.0	08.6	327 15.7	00.3		241 51.2	00.3				Miaplacidus	221 38.3	S69 47.3	
23	152 04.4	183 46.8	51.4	272 54.6	08.8	342 18.5	00.5		256 53.6	00.3								
WEDNESDAY	00	167 06.9	198 46.3	S13 50.4	287 56.1	S19 09.0	357 21.3	N 6 00.6		271 56.0	S21 00.3			Mirtak	308 37.8	N49 55.1		
	01	182 09.3	213 45.7	49.5	302 57.7	09.2	12 24.0	00.7		286 58.4	00.3			Nunki	75 56.2	S26 16.4		
	02	197 11.8	228 45.1	48.5	317 59.2	09.4	27 26.8	00.8		302 00.8	00.4			Peacock	53 16.8	S56 40.7		
	03	212 14.3	243 44.6	47.5	333 00.8	09.6	42 29.6	01.0		317 03.1	00.4			Pollux	243 25.3	N27 59.0		
	04	227 16.7	258 44.0	46.6	348 02.3	09.8	57 32.3	01.1		332 05.5	00.4			Procyon	244 57.6	N 5 10.7		
	05	242 19.2	273 43.5	45.6	3 03.9	10.0	72 35.1	01.2		347 07.9	00.4							
	06	257 21.7	288 42.9	S13 44.6	18 05.5	S19 10.2	87 37.9	N 6 01.4		2 10.3	S21 00.4				Rasalhague	96 04.8	N12 32.9	
	07	272 24.1	303 42.3	43.6	33 07.0	10.4	102 40.6	01.5		17 12.7	00.4				Regulus	207 41.3	N11 53.1	
	08	287 26.6	318 41.8	42.7	48 08.6	10.7	117 43.4	01.6		32 15.1	00.4				Rigel	281 10.3	S 8 11.4	
	09	302 29.1	333 41.2	41.7	63 10.1	10.9	132 46.2	01.8		47 17.5	00.4				Rigel Kent.	139 48.7	S60 53.8	
	10	317 31.5	348 40.7	40.7	78 11.7	11.1	147 48.9	01.9		62 19.9	00.4				Sabik	102 10.4	S15 44.5	
	11	332 34.0	3 40.1	39.7	93 13.3	11.3	162 51.7	02.0		77 22.3	00.4							
	12	347 36.4	18 39.5	S13 38.8	108 14.8	S19 11.5	177 54.5	N 6 02.1		92 24.7	S21 00.4				Schedar	349 38.8	N56 37.5	
	13	2 38.9	33 39.0	37.8	123 16.4	11.7	192 57.2	02.3		107 27.1	00.4				Shaula	96 19.4	S37 06.6	
	14	17 41.4	48 38.4	36.8	138 18.0	11.9	208 00.0	02.4		122 29.5	00.4				Sirius	258 32.0	S16 44.7	
	15	32 43.8	63 37.9	35.8	153 19.5	12.1	223 02.8	02.5		137 31.9	00.4				Spica	158 29.0	S11 14.8	
	16	47 46.3	78 37.3	34.8	168 21.1	12.3	238 05.5	02.7		152 34.2	00.4				Suhail	222 50.7	S43 30.2	
	17	62 48.8	93 36.8	33.9	183 22.7	12.5	253 08.3	02.8		167 36.6	00.4							
	18	77 51.2	108 36.2	S13 32.9	198 24.2	S19 12.7	268 11.1	N 6 02.9		182 39.0	S21 00.4				Vega	80 37.8	N38 47.8	
	19	92 53.7	123 35.7	31.9	213 25.8	12.9	283 13.8	03.0		19								

A₂ ALTITUDE CORRECTION TABLES 10°-90°—SUN, STARS, PLANETS

OCT.—MAR. SUN			APR.—SEPT.			STARS AND PLANETS				DIP				
App. Alt.	Lower Limb	Upper Limb	App. Alt.	Lower Limb	Upper Limb	App. Alt.	Corr ⁿ	App. Alt.	Additional Corr ⁿ	Ht. of Eye	Corr ⁿ	Ht. of Eye	Ht. of Eye	Corr ⁿ
9 33	+10.8	-21.5	9 39	+10.6	-21.2	9 55	-5.3		2016	m		ft.		
9 45	+10.9	-21.4	9 50	+10.7	-21.1	10 07	-5.2		VENUS	2.4	-2.8	8.0	1.0	-1.8
9 56	+11.0	-21.3	10 02	+10.8	-21.0	10 20	-5.2		Jan. 1-Dec. 3	2.6	-2.9	8.6	1.5	-2.2
10 08	+11.1	-21.2	10 14	+10.9	-20.9	10 32	-5.1		0	3.0	-3.0	9.2	2.0	-2.5
10 20	+11.2	-21.1	10 27	+11.0	-20.8	10 46	-5.0		60 +0.1	3.2	-3.1	10.5	2.5	-2.8
10 33	+11.3	-21.0	10 40	+11.1	-20.7	10 59	-4.9		Dec. 4-Dec. 31	3.4	-3.2	11.2	3.0	-3.0
10 46	+11.4	-20.9	10 53	+11.2	-20.6	11 14	-4.8		0	3.6	-3.3	11.9		See table
11 00	+11.5	-20.8	11 07	+11.3	-20.5	11 29	-4.7		41 +0.2	3.8	-3.4	12.6		←
11 15	+11.6	-20.7	11 22	+11.4	-20.4	11 44	-4.6		76 +0.1	4.0	-3.5	13.3	m	/
11 30	+11.7	-20.6	11 37	+11.5	-20.3	12 00	-4.5			4.3	-3.6	14.1	20	-7.9
11 45	+11.8	-20.5	11 53	+11.6	-20.2	12 17	-4.4		MARS	4.5	-3.7	14.9	22	-8.3
12 01	+11.9	-20.4	12 10	+11.7	-20.1	12 35	-4.3		Jan. 1-Mar. 11	4.7	-3.8	15.7	24	-8.6
12 18	+12.0	-20.3	12 27	+11.8	-20.0	12 53	-4.2		Sept. 16-Dec. 31	5.0	-3.9	16.5	26	-9.0
12 36	+12.1	-20.2	12 45	+11.9	-19.9	13 12	-4.1		0	5.2	-4.0	17.4	28	-9.3
12 54	+12.2	-20.1	13 04	+12.0	-19.8	13 32	-4.0		60 +0.1	5.5	-4.1	18.3	30	-9.6
13 14	+12.3	-20.0	13 24	+12.1	-19.7	13 53	-3.9			5.8	-4.2	19.1	32	-10.0
13 34	+12.4	-19.9	13 44	+12.2	-19.6	14 16	-3.8		Mar. 12-Apr. 30	6.1	-4.3	20.1	34	-10.3
13 55	+12.5	-19.8	14 06	+12.3	-19.5	14 39	-3.7		July 5-Sept. 15	6.3	-4.4	21.0	36	-10.6
14 17	+12.6	-19.7	14 29	+12.4	-19.4	15 03	-3.6		0	6.6	-4.5	22.0	38	-10.8
14 41	+12.7	-19.6	14 53	+12.5	-19.3	15 29	-3.5		41 +0.2	6.9	-4.6	22.9		
15 05	+12.8	-19.5	15 18	+12.6	-19.2	15 56	-3.4		76 +0.1	7.2	-4.7	23.9	40	-11.1
15 31	+12.9	-19.4	15 45	+12.7	-19.1	16 25	-3.3			7.5	-4.8	24.9	42	-11.4
15 59	+13.0	-19.3	16 13	+12.8	-19.0	16 55	-3.2		May 1-July 4	7.9	-4.9	26.0	44	-11.7
16 27	+13.1	-19.2	16 43	+12.9	-18.9	17 27	-3.1		0	8.2	-5.0	27.1	46	-11.9
16 58	+13.2	-19.1	17 14	+13.0	-18.8	18 01	-3.0		34 +0.3	8.5	-5.1	28.1	48	-12.2
17 30	+13.3	-19.0	17 47	+13.1	-18.7	18 37	-2.9		60 +0.2	8.8	-5.2	29.2		
18 05	+13.4	-18.9	18 23	+13.2	-18.6	19 16	-2.8		80 +0.1	9.2	-5.3	30.4	ft.	/
18 41	+13.5	-18.8	19 00	+13.3	-18.5	19 56	-2.7			9.5	-5.4	31.5	2	-1.4
19 20	+13.6	-18.7	19 41	+13.4	-18.4	20 40	-2.6			9.9	-5.5	32.7	4	-1.9
20 02	+13.7	-18.6	20 24	+13.5	-18.3	21 27	-2.5			10.3	-5.6	33.9	6	-2.4
20 46	+13.8	-18.5	21 10	+13.6	-18.2	22 17	-2.4			10.6	-5.7	35.1	8	-2.7
21 34	+13.9	-18.4	21 59	+13.7	-18.1	23 11	-2.3			11.0	-5.8	36.3	10	-3.1
22 25	+14.0	-18.3	22 52	+13.8	-18.0	24 09	-2.2			11.4	-5.9	37.6		See table
23 20	+14.1	-18.2	23 49	+13.9	-17.9	25 12	-2.1			11.8	-6.0	38.9		←
24 20	+14.2	-18.1	24 51	+14.0	-17.8	26 20	-2.0			12.2	-6.1	40.1	ft.	/
25 24	+14.3	-18.0	25 58	+14.1	-17.7	27 34	-1.9			12.6	-6.2	41.5	70	-8.1
26 34	+14.4	-17.9	27 11	+14.2	-17.6	28 54	-1.8			13.0	-6.3	42.8	75	-8.4
27 50	+14.5	-17.8	28 31	+14.3	-17.5	30 22	-1.7			13.4	-6.4	44.2	80	-8.7
29 13	+14.6	-17.7	29 58	+14.4	-17.4	31 58	-1.6			13.8	-6.5	45.5	85	-8.9
30 44	+14.7	-17.6	31 33	+14.5	-17.3	33 43	-1.5			14.2	-6.6	46.9	90	-9.2
32 24	+14.8	-17.5	33 18	+14.6	-17.2	35 38	-1.4			14.7	-6.7	48.4	95	-9.5
34 15	+14.9	-17.4	35 15	+14.7	-17.1	37 45	-1.3			15.1	-6.8	49.8		
36 17	+15.0	-17.3	37 24	+14.8	-17.0	40 06	-1.2			15.5	-6.9	51.3	100	-9.7
38 34	+15.1	-17.2	39 48	+14.9	-16.9	42 42	-1.1			16.0	-7.0	52.8	105	-9.9
41 06	+15.2	-17.1	42 28	+15.0	-16.8	45 34	-1.0			16.5	-7.1	54.3	110	-10.2
43 56	+15.3	-17.0	45 29	+15.1	-16.7	48 45	-0.9			16.9	-7.2	55.8	115	-10.4
47 07	+15.4	-16.9	48 52	+15.2	-16.6	52 16	-0.8			17.4	-7.3	57.4	120	-10.6
50 43	+15.5	-16.8	52 41	+15.3	-16.5	56 09	-0.7			17.9	-7.4	58.9	125	-10.8
54 46	+15.6	-16.7	56 59	+15.4	-16.4	60 26	-0.6			18.4	-7.5	60.5		
59 21	+15.7	-16.6	61 50	+15.5	-16.3	65 06	-0.5			18.8	-7.6	62.1	130	-11.1
64 28	+15.8	-16.5	67 15	+15.6	-16.2	70 09	-0.4			19.3	-7.7	63.8	135	-11.3
70 10	+15.9	-16.4	73 14	+15.7	-16.1	75 32	-0.3			19.8	-7.8	65.4	140	-11.5
76 24	+16.0	-16.3	79 42	+15.8	-16.0	81 12	-0.2			20.4	-7.9	67.1	145	-11.7
83 05	+16.1	-16.2	86 31	+15.9	-15.9	87 03	-0.1			20.9	-8.0	68.8	150	-11.9
90 00			90 00			90 00	0.0			21.4	-8.1	70.5	155	-12.1

App. Alt. = Apparent altitude = Sextant altitude corrected for index error and dip.

Figure 1906c. A₂ Altitude Correction Tables 10° - 90° for Sun, Stars, Planets.

The difference between the tabulated altitudes for 45° and 46° is given in *Pub. 229* as the value d ; in this case, $d = +10.8'$. Note it is not in italics and followed by a dot, which makes the interpolation easier. There are two ways to do this interpolation. First, we could use the Interpolation Table on the inside front and back covers of *Pub 229*. We find the value of $+3.6'$. Alternatively, we can easily compute the value. Express as a ratio the declination increment (in this case, $20.2'$) and the total interval between the tabulated declination values (in this case, $60'$) to obtain the 'distance' between the tabulated declination values represented by the declination increment. Next, multiply that by d , paying attention to the sign. In this case: $(20.2'/60') \times (+10.8') = +3.6'$.

As expected, the two methods (using the Interpolation Table or computation) give the same result. Add $3.6'$ to the tabulated altitude to obtain the final computed altitude: $H_c = 50^\circ 14.1'$.

It will be valuable here to review exactly what h_o and h_c represent. Recall the methodology of the altitude-intercept method. The navigator first measures and corrects an altitude for a celestial body. This corrected altitude, h_o , corresponds to a circle of equal altitude passing through the navigator's actual position whose center is the geographic position (GP) of the body. The navigator then determines an assumed position (AP) near, but not coincident with, his or her actual position; they then calculate an altitude for an observer at that assumed position (AP). The circle of equal altitude passing through this assumed position is concentric with the circle of equal altitude passing through the navigator's actual position. The difference between the body's altitude at the assumed position (h_c) and the body's observed altitude (h_o) is equal to the differences in radii length of the two corresponding circles of equal altitude.

In the above problem, therefore, the navigator knows that the equal altitude circle passing through his or her actual position is understood as: the difference between h_o and h_c is $50^\circ 25.8' - 50^\circ 14.1' = 11.7'$ (which is 11.7 nautical miles) away from the equal altitude circle passing through his or her actual position. Since h_o is greater than h_c , the navigator knows that the radius of the equal altitude circle passing through his or her actual position is less than the radius of the equal altitude circle passing through the assumed position. The only remaining question is what direction from the assumed position is the body's actual GP. *Pub. 229* provides this final piece of information. This is the value for Z which is tabulated with the h_c and d values discussed above. In this case, enter *Pub. 229* as before, with LHA, assumed latitude, and declination. Extract the value $Z = 063.3^\circ$. Interpolation is not required. The relation between Z and Z_n , the true azimuth, is as follows:

In northern latitudes:

$$\begin{aligned} \text{LHA} > 180^\circ, & \text{ then } Z_n = Z \\ \text{LHA} < 180^\circ, & \text{ then } Z_n = 360^\circ - Z \end{aligned}$$

In southern latitudes:

$$\begin{aligned} \text{LHA} > 180^\circ, & \text{ then } Z_n = 180^\circ - Z \\ \text{LHA} < 180^\circ, & \text{ then } Z_n = 180^\circ + Z \end{aligned}$$

In this case, $\text{LHA} > 180^\circ$ and the vessel is in northern latitude. Therefore, $Z_n = Z = 063.3^\circ$. The navigator now has enough information to plot a line of position.

Using the same technique, reduce the sights of Antares and Alkaid. The values for the sight reductions are shown in Figure 1906a.

1907. Reducing a Sun Sight

The example below points out the similarities between reducing a sun sight and reducing a star sight. It also demonstrates the additional corrections required for low altitude ($<10^\circ$) sights and sights taken during non-standard temperature and pressure conditions.

On March 09, 2016, at 07-00-24 local time, at DR position $L 39^\circ 11.0' N \lambda 45^\circ 22.0' W$, a navigator takes a sight of the Sun's lower limb. The navigator has a height of eye of 68 feet, the temperature is $88^\circ F$, and the atmospheric pressure is 982 mb. The sextant altitude is $6^\circ 37.5'$. There is an index correction of $+0.2'$. Determine the observed altitude, computed altitude, and azimuth.

A completed strip form showing the values from this example is shown in Figure 1907a.

Apply the index and dip corrections to h_s to obtain h_a . Because h_a is less than 10° , use the special altitude correction table for sights between 0° and 10° located on the right inside front page of the *Nautical Almanac*.

Enter the table with the apparent altitude, the limb of the Sun used for the sight, and the period of the year. Interpolation for the apparent altitude is not required. In this case, the table yields a correction of $+8.4'$. The correction's algebraic sign is found at the head of each group of entries and at every change of sign.

An additional correction is required because of the non-standard temperature and atmospheric pressure under which the sight was taken. The correction for these non-standard conditions is found in the *Additional Corrections* table located on page A4 in the front of the *Nautical Almanac*.

First, enter the *Additional Corrections* table with the temperature and pressure to determine the correct zone letter: in this case, zone M. Then, locate the correction in the M column corresponding to the apparent altitude of $6^\circ 29.7'$. Interpolate between the table arguments of $6^\circ 00.0'$

OPNAV 3530/40 (4-73) H.O. 229 NAUT ALM		NAVIGATION WORKBOOK OPNAV 3530/1 (Rev 7-74)		
Date	DATE/DR POSIT 9 Mar 2016 39° 11' N, 045° 22.0 W	DATE/DR POSIT 22 Mar 2016 DR not given in example	DATE/DR POSIT 9 Mar 2016 DR not given in example	DATE/DR POSIT
Body	Sun LL	Moon LL	Mars	
GMT	10-00-24	21-01-04	08-58-34	
IC	+0.2'	+0.2'	+0.2'	
D	-8.0'	-8.0'	-8.0'	
Sum	-7.8'	-7.8'	-7.8'	
hs	6° 37.5'	3° 55.0'	29° 43.0'	
ha	6° 29.7'	3° 47.2'	29° 35.2'	
Alt Corr	+8.4'	+56.1'	-1.7'	
Add'l Corr Moon HP/Corr	+0.8'	+0.7'	+0.1'	
Ho	6° 38.9'	4° 44.0'	29° 33.6'	
GHA (h)	327° 23.6'	319° 28.2'	48° 8.6'	
Incre (m/s)	6.0'	+15.3'	14° 38.5'	
v/v Corr SHA	—	15.0 / +0.4'	1.5'	
Total GHA	327° 29.6'	319° 43.9'	62° 48.6'	
± 360°	—	—	—	
aλ (+E, -W)	045° 29.6' W			
LHA	282°			
Tab Dec	S 4° 14.9'	N 1° 59.8'	S 19° 10.7'	
d# / d cor	-1.0 / 0.0'	-9.4 / -0.2'	+0.2 / +0.2'	
True Dec	S 4° 14.9'	N 1° 59.6'	S 19° 10.9'	
a LAT Same Contrary	39° cont			
Dec Inc / d	14.9' / -38.6'			
Tens / DSD	—			
Units / DSD Corr	—			
Total Corr	-9.6'			
Hc (Tab)	6° 44.1'			
Hc (Comp)	6° 34.5'			
Ho	6° 38.9'			
a	4.4' toward			
Z	100.7°			
Zn	100.7°			
Fix Lat				
Long				
Fix Time				
Sounding				
Signature				USN NAVIGATOR

Figure 1907a. Strip for showing example values for Sun, Moon, and Mars.

and $7^{\circ} 00.0'$ to determine the additional correction: $+0.8'$. The total correction to the apparent altitude is the sum of the altitude and additional corrections: $+9.2'$. This results in an h_o of $6^{\circ} 38.9'$.

Date	09 March 2016
DR Latitude	N $39^{\circ} 11.01'$
DR Longitude	W $045^{\circ} 22.0'$
Observation Time	07-00-24
Watch Error	0
Zone Time	07-00-24
Zone Description	+3
UT/GMT	10-00-24

Next, determine the Sun's GHA and declination. Again, this process is similar to the star sights reduced above. See Figure 1907b. Notice, however, that SHA, a quantity unique to star sight reduction, is not used in Sun sight reduction.

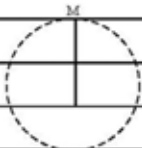
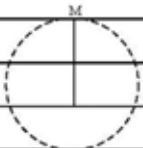
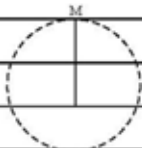
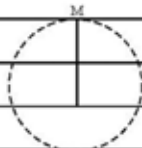
Determining the Sun's GHA is less complicated than determining a star's GHA. The *Nautical Almanac's* daily pages list the Sun's GHA in hourly increments. In this case, the Sun's GHA at 1000 GMT on March 09, 2016 is $327^{\circ} 23.6'$. The v correction is not applicable for a Sun sight; therefore, applying the increment correction yields the Sun's GHA. In this case, the GHA is $327^{\circ} 29.6'$.

Determining the Sun's LHA is similar to determining a star's LHA; see Section 1906 if more details are needed. In determining the Sun's declination, however, an additional correction not encountered in the star sight, the d correction, must be considered. This is because the Sun moves in declination over the course of an hour, unlike that of the stars; the d value is an interpolation factor for the Sun's declination. The bottom of the Sun column on the daily pages of the *Nautical Almanac* lists the d value. The sign of the d factor must be determined by noting from the *Almanac* whether the Sun's declination value is increasing or decreasing around the time of observation. If it is increasing, the factor is positive; if it is decreasing, the factor is negative. In the above problem, the Sun's declination value is decreasing throughout the day. Therefore, the d factor is -1.0 .

Having obtained the d factor, enter the 00 minute increment and correction table. Under the column labeled " v or d corrⁿ," find the value for d in the left hand column. The corresponding number in the right hand column is the correction. Apply the correction to the tabulated declination. In this case, the correction corresponding to a d value of -1.0 is $0.0'$.

The final step will be to determine h_c and Zn. Enter *Pub.* 229 with an LHA of 282° , a declination of $S4^{\circ} 14.9'$, and an assumed latitude of $39^{\circ}N$. The remaining values to determine h_c and Zn are shown on the strip form (Figure 1907a).

1908. Reducing a Moon Sight

The Moon is easy to identify and is often visible during the day. However, the Moon's proximity to the Earth requires applying additional corrections to h_a to obtain h_o . This section will cover Moon sight reduction.

At 21-01-04 UT, March 22, 2016, under standard meteorological conditions, the navigator obtains a sight of the Moon's lower limb. h_s is $3^{\circ} 55.0'$. Height of eye is 68 feet and the index correction is $+0.2'$. Determine h_o , the Moon's GHA, and the Moon's declination.

A completed strip form showing the values from this example is shown in Figure 1907a. Also see Figure 1908a.

This example demonstrates the extra corrections required for obtaining h_o for a Moon sight. Apply the index and dip corrections in the same manner as for star and Sun sights.

The altitude correction for the Moon comes from tables located on the inside back covers of the *Nautical Almanac*. Figure 1908b. In this case, the apparent altitude was $3^{\circ} 47.2'$. Enter the altitude correction table for the Moon with the above apparent altitude. Interpolation is not required. The correction is $+56.1'$. An arrow shows the correct location of this correction.

The altitude correction due to horizontal parallax (HP) is unique to Moon sights. The table for determining this correction is directly under the main altitude correction table for the Moon, on the back inside cover of the *Nautical Almanac* (see Figure 1908b). First, go to the daily page for March 22 at 21-00-00 UT/GMT (see Figure 1908a). In the column for the Moon, find the HP corresponding to 21-00-00. Its value is $54.3'$ (no interpolation is required). Take this value to the Altitude Correction Tables for the Moon on the inside back cover of the *Almanac*. Notice that the HP correction columns line up vertically with the apparent altitude correction table columns. Find the HP correction column directly under the apparent altitude correction table heading corresponding to the apparent altitude. Enter that column with the HP from the daily pages. The column has two sets of figures listed under "L" and "U" for lower and upper limb respectively. In this case, trace down the "L" column until it intersects with the HP of $54.3'$. The altitude correction due to the Moon's horizontal parallax is $+0.7'$ in our example; an arrow shows the location of this correction. Interpolation is not required.

An additional correction based on non-standard weather condition is not applicable in this case because the sight was taken under standard temperature and pressure conditions.

The total correction to h_a is the sum of all the corrections; in this case, this total correction is $+56.8'$.

To obtain the Moon's GHA, enter the daily pages in the Moon column and extract the applicable data just as for a star or Sun sight. Determining the Moon's GHA requires an additional correction, the v correction. The v correction is needed because the Moon's motion is not close to uniform

2016 MARCH 7, 8, 9 (MON., TUES., WED.)

UT	SUN		MOON						Lat.	Twilight			Sunrise	Moonrise				
	GHA	Dec	GHA	v	Dec	d	HP	Naut.		Civil	h m	h m		h m	h m	h m	h m	h m
7 00	177 14.7	S 5 11.5	205 09.1	7.7	S12 30.7	8.3	59.5	N 72	04 31	05 51	06 58	07 13	07 08	07 03	06 58			
01	192 14.9	10.6	219 35.8	7.8	12 22.4	8.4	59.5	N 70	04 41	05 52	06 53	06 53	06 56	06 58	07 00			
02	207 15.0	09.6	234 02.6	7.8	12 14.0	8.5	59.5	68	04 48	05 53	06 49	06 38	06 47	06 55	07 01			
03	222 15.2	08.6	248 29.4	7.8	12 05.5	8.5	59.6	66	04 54	05 54	06 45	06 25	06 40	06 52	07 03			
04	237 15.3	07.6	262 56.2	7.7	11 57.0	8.7	59.6	64	04 59	05 55	06 42	06 15	06 33	06 49	07 04			
05	252 15.5	06.7	277 22.9	7.8	11 48.3	8.7	59.6	62	05 04	05 55	06 39	06 06	06 27	06 47	07 05			
06	267 15.6	S 5 05.7	291 49.7	7.7	S11 39.6	8.8	59.7	60	05 07	05 55	06 37	05 58	06 22	06 44	07 06			
07	282 15.8	04.7	306 16.4	7.8	11 30.8	8.9	59.7	N 58	05 10	05 56	06 35	05 51	06 18	06 43	07 06			
08	297 15.9	03.7	320 43.2	7.7	11 21.9	9.0	59.7	56	05 13	05 56	06 33	05 45	06 14	06 41	07 07			
09	312 16.1	02.8	335 09.9	7.8	11 12.9	9.1	59.8	54	05 15	05 56	06 31	05 39	06 11	06 40	07 08			
10	327 16.2	01.8	349 36.7	7.7	11 03.8	9.1	59.8	52	05 17	05 56	06 29	05 34	06 07	06 38	07 08			
11	342 16.4	5 00.8	4 03.4	7.7	10 54.7	9.2	59.8	50	05 18	05 56	06 28	05 30	06 05	06 37	07 09			
12	357 16.5	S 4 59.8	18 30.1	7.8	S10 45.5	9.3	59.9	45	05 22	05 56	06 25	05 20	05 58	06 34	07 10			
13	12 16.7	58.9	32 56.9	7.7	10 36.2	9.4	59.9	N 40	05 24	05 55	06 22	05 12	05 53	06 32	07 11			
14	27 16.8	57.9	47 23.6	7.7	10 26.8	9.4	59.9	35	05 25	05 55	06 20	05 05	05 48	06 30	07 12			
15	42 17.0	56.9	61 50.3	7.8	10 17.4	9.6	60.0	30	05 26	05 54	06 18	04 59	05 44	06 29	07 12			
16	57 17.1	55.9	76 17.1	7.7	10 07.8	9.6	60.0	20	05 26	05 52	06 14	04 48	05 37	06 26	07 14			
17	72 17.3	55.0	90 43.8	7.7	9 58.2	9.6	60.0	N 10	05 25	05 50	06 11	04 39	05 31	06 23	07 15			
18	87 17.4	S 4 54.0	105 10.5	7.7	S 9 48.6	9.8	60.0	0	05 23	05 47	06 07	04 30	05 25	06 21	07 16			
19	102 17.6	53.0	119 37.2	7.8	9 38.8	9.8	60.1	S 10	05 18	05 43	06 04	04 21	05 19	06 18	07 17			
20	117 17.7	52.0	134 04.0	7.7	9 29.0	9.9	60.1	20	05 12	05 38	06 00	04 12	05 13	06 16	07 18			
21	132 17.9	51.1	148 30.7	7.7	9 19.1	10.0	60.1	30	05 04	05 32	05 56	04 01	05 06	06 13	07 20			
22	147 18.0	50.1	162 57.4	7.7	9 09.1	10.0	60.2	35	04 58	05 28	05 53	03 55	05 02	06 11	07 21			
23	162 18.2	49.1	177 24.1	7.7	8 59.1	10.1	60.2	40	04 51	05 23	05 50	03 48	04 58	06 09	07 22			
8 00	177 18.3	S 4 48.1	191 50.8	7.8	S 8 49.0	10.1	60.2	45	04 42	05 17	05 47	03 39	04 52	06 07	07 23			
01	192 18.5	47.2	206 17.6	7.7	8 38.9	10.2	60.2	S 50	04 31	05 10	05 43	03 29	04 46	06 04	07 24			
02	207 18.7	46.2	220 44.3	7.7	8 28.7	10.3	60.3	52	04 25	05 07	05 41	03 25	04 43	06 03	07 25			
03	222 18.8	45.2	235 11.0	7.7	8 18.4	10.4	60.3	54	04 19	05 03	05 39	03 20	04 39	06 02	07 26			
04	237 19.0	44.2	249 37.7	7.7	8 08.0	10.4	60.3	56	04 12	04 58	05 37	03 14	04 36	06 01	07 27			
05	252 19.1	43.3	264 04.4	7.8	7 57.6	10.5	60.3	58	04 04	04 54	05 34	03 08	04 32	05 59	07 27			
06	267 19.3	S 4 42.3	278 31.2	7.7	S 7 47.1	10.5	60.4	S 60	03 54	04 48	05 31	03 00	04 27	05 57	07 28			
07	282 19.4	41.3	292 57.9	7.7	7 36.6	10.6	60.4	Lat.	Sunset	Twilight			Moonset					
08	297 19.6	40.3	307 24.6	7.7	7 26.0	10.6	60.4			Civil	Naut.	7	8	9	10			
09	312 19.7	39.3	321 51.3	7.7	7 15.4	10.7	60.4											
10	327 19.9	38.4	336 18.0	7.7	7 04.7	10.8	60.5											
11	342 20.0	37.4	350 44.7	7.8	6 53.9	10.8	60.5	N 72	17 25	18 33	19 53	14 32	16 33	18 34	20 34			
12	357 20.2	S 4 36.4	5 11.5	7.7	S 6 43.1	10.8	60.5	N 70	17 30	18 31	19 44	14 50	16 42	18 35	20 28			
13	12 20.3	35.4	19 38.2	7.7	6 32.3	10.9	60.5	68	17 35	18 30	19 36	15 04	16 49	18 36	20 24			
14	27 20.5	34.5	34 04.9	7.7	6 21.4	11.0	60.6	66	17 38	18 29	19 29	15 16	16 55	18 37	20 20			
15	42 20.7	33.5	48 31.6	7.7	6 10.4	11.0	60.6	64	17 41	18 28	19 24	15 25	17 01	18 38	20 16			
16	57 20.8	32.5	62 58.3	7.7	5 59.4	11.0	60.6	62	17 44	18 28	19 20	15 33	17 05	18 39	20 14			
17	72 21.0	31.5	77 25.0	7.7	5 48.4	11.1	60.6	60	17 46	18 27	19 16	15 40	17 09	18 40	20 11			
18	87 21.1	S 4 30.6	91 51.7	7.8	S 5 37.3	11.1	60.6	N 58	17 48	18 27	19 13	15 46	17 12	18 40	20 09			
19	102 21.3	29.6	106 18.5	7.7	5 26.2	11.2	60.7	56	17 50	18 27	19 10	15 52	17 15	18 41	20 07			
20	117 21.4	28.6	120 45.2	7.7	5 15.0	11.2	60.7	54	17 51	18 27	19 08	15 57	17 18	18 41	20 05			
21	132 21.6	27.6	135 11.9	7.7	5 03.8	11.3	60.7	52	17 53	18 27	19 06	16 01	17 20	18 42	20 03			
22	147 21.7	26.6	149 38.6	7.7	4 52.5	11.3	60.7	50	17 54	18 26	19 04	16 05	17 23	18 42	20 02			
23	162 21.9	25.7	164 05.3	7.7	S 4 41.2	11.3	60.7	45	17 57	18 27	19 01	16 13	17 27	18 43	19 59			
9 00	177 22.1	S 4 24.7	A total eclipse of the Sun occurs on this date. See page 5.					N 40	18 00	18 27	18 58	16 20	17 31	18 44	19 56			
01	192 22.2	23.7						35	18 02	18 27	18 57	16 26	17 35	18 44	19 54			
02	207 22.4	22.7						30	18 04	18 28	18 56	16 32	17 38	18 45	19 52			
03	222 22.5	21.7						20	18 08	18 30	18 55	16 41	17 43	18 45	19 48			
04	237 22.7	20.8						N 10	18 11	18 32	18 56	16 49	17 47	18 46	19 45			
05	252 22.8	19.8						0	18 14	18 35	18 59	16 56	17 52	18 47	19 42			
06	267 23.0	S 4 18.8	265 12.3	7.7	S 3 21.2	11.5	60.8	S 10	18 17	18 38	19 03	17 04	17 56	18 47	19 39			
07	282 23.2	17.8	279 39.0	7.7	3 09.7	11.6	60.8	20	18 21	18 43	19 09	17 11	18 00	18 48	19 36			
08	297 23.3	16.9	294 05.7	7.7	2 58.1	11.6	60.9	30	18 25	18 49	19 17	17 20	18 05	18 49	19 33			
09	312 23.5	15.9	308 32.4	7.7	2 46.5	11.6	60.9	35	18 27	18 53	19 23	17 25	18 08	18 49	19 31			
10	327 23.6	14.9	322 59.1	7.7	2 34.9	11.6	60.9	40	18 30	18 57	19 30	17 31	18 11	18 50	19 28			
11	342 23.8	13.9	337 25.8	7.7	2 23.3	11.7	60.9	45	18 33	19 03	19 38	17 38	18 15	18 50	19 26			
12	357 23.9	S 4 12.9	351 52.5	7.7	S 2 11.6	11.7	60.9	S 50	18 37	19 10	19 49	17 45	18 19	18 51	19 22			
13	12 24.1	12.0	6 19.2	7.7	1 59.9	11.6	60.9	52	18 39	19 13	19 55	17 49	18 21	18 51	19 21			
14	27 24.3	11.0	20 45.9	7.7	1 48.3	11.7	60.9	54	18 41	19 17	20 01	17 53	18 23	18 51	19 19			
15	42 24.4	10.0	35 12.6	7.7	1 36.6	11.8	60.9	56	18 43	19 21	20 08	17 57	18 25	18 52	19 18			
16	57 24.6	09.0	49 39.3	7.7	1 24.8	11.7	60.9	58	18 46	19 26	20 16	18 02	18 28	18 52	19 16			
17	72 24.7	08.0	64 06.0	7.7	1 13.1	11.7	60.9	S 60	18 49	19 31	20 25	18 08	18 31	18 52	19 13			
18	87 24.9	S 4 07.1	78 32.7	7.7	S 1 01.4	11.8	60.9	SUN			MOON							
19	102 25.1	06.1	92 59.4	7.6	0 49.6	11.8	61.0	Day										

2016 MARCH 22, 23, 24 (TUES., WED., THURS.)

UT	SUN		MOON				Lat.	Twilight		Sunrise	Moonrise																
	GHA Dec		GHA	v	Dec	d		HP	Naut.		Civil	22	23	24	25												
	°	'	°	'	°	'		'	°		'	h	m	h	m	h	m	h	m								
22 00	178	16.7 N	0	42.9	13	39.7	14.5 N	5	13.5	9.1	54.6	N 72	02	57	04	32	05	41	17	04	18	38	20	11	21	45	
01	193	16.9		43.9	28	13.2	14.5		5	04.4	9.1	54.5	N 70	03	20	04	41	05	44	17	08	18	35	20	03	21	30
02	208	17.1		44.9	42	46.7	14.6		4	55.3	9.2	54.5	68	03	37	04	49	05	46	17	11	18	34	19	56	21	19
03	223	17.3		45.9	57	20.3	14.6		4	46.1	9.1	54.5	66	03	51	04	56	05	47	17	13	18	32	19	51	21	10
04	238	17.5		46.9	71	53.9	14.6		4	37.0	9.1	54.5	64	04	02	05	01	05	49	17	15	18	31	19	47	21	02
05	253	17.6		47.9	86	27.5	14.7		4	27.9	9.2	54.5	62	04	11	05	06	05	50	17	17	18	30	19	43	20	55
06	268	17.8	N	0	48.8	101	01.2	14.6 N	4	18.7	9.2	54.5	60	04	19	05	10	05	51	17	19	18	29	19	40	20	49
07	283	18.0		49.8	115	34.8	14.7		4	09.5	9.2	54.5	N 58	04	26	05	13	05	52	17	20	18	29	19	37	20	44
08	298	18.2		50.8	130	08.5	14.7		4	00.3	9.2	54.5	56	04	32	05	16	05	53	17	21	18	28	19	34	20	40
09	313	18.4		51.8	144	42.2	14.8		3	51.1	9.2	54.4	54	04	37	05	19	05	54	17	22	18	27	19	32	20	36
10	328	18.6		52.8	159	16.0	14.7		3	41.9	9.3	54.4	52	04	41	05	21	05	55	17	23	18	27	19	29	20	32
11	343	18.8		53.8	173	49.7	14.8		3	32.6	9.2	54.4	50	04	45	05	23	05	56	17	24	18	26	19	28	20	29
12	358	19.0	N	0	54.8	188	23.5	14.8 N	3	23.4	9.3	54.4	45	04	53	05	28	05	57	17	26	18	25	19	23	20	21
13	13	19.2		55.7	202	57.3	14.8		3	14.1	9.2	54.4	N 40	04	59	05	31	05	58	17	28	18	24	19	20	20	15
14	28	19.3		56.7	217	31.1	14.8		3	04.9	9.3	54.4	35	05	04	05	34	05	59	17	29	18	23	19	17	20	10
15	43	19.5		57.7	232	04.9	14.9		2	55.6	9.3	54.4	30	05	08	05	36	06	00	17	31	18	23	19	14	20	06
16	58	19.7		58.7	246	38.8	14.8		2	46.3	9.3	54.4	20	05	14	05	39	06	01	17	33	18	21	19	10	19	58
17	73	19.9		59.7	261	12.6	14.9		2	37.0	9.3	54.4	N 10	05	17	05	41	06	02	17	35	18	20	19	06	19	51
18	88	20.1	N	1	00.7	275	46.5	14.9 N	2	27.7	9.3	54.4	0	05	19	05	43	06	03	17	37	18	19	19	02	19	45
19	103	20.3		01.6	290	20.4	14.9		2	18.4	9.3	54.3	S 10	05	19	05	43	06	04	17	38	18	18	18	58	19	39
20	118	20.5		02.6	304	54.3	14.9		2	09.1	9.3	54.3	20	05	21	05	43	06	05	17	40	18	17	18	54	19	32
21	133	20.7		03.6	319	28.2	15.0		1	59.8	9.4	54.3	10	05	14	05	42	06	05	17	43	18	16	18	50	19	24
22	148	20.9		04.6	334	02.2	14.9		1	50.4	9.3	54.3	05	05	11	05	41	06	06	17	44	18	16	18	47	19	20
23	163	21.0		05.6	348	36.1	15.0		1	41.1	9.3	54.3	40	05	08	05	39	06	06	17	45	18	15	18	45	19	15
23 00	178	21.2	N	1	06.6	3	10.1	15.0 N	1	31.8	9.4	54.3	45	05	03	05	37	06	07	17	47	18	14	18	41	19	09
01	193	21.4		07.6	17	44.1	15.0		1	22.4	9.3	54.3	S 50	04	57	05	35	06	07	17	49	18	13	18	37	19	03
02	208	21.6		08.5	32	18.1	15.0		1	13.1	9.4	54.3	52	04	54	05	34	06	07	17	50	18	13	18	36	19	00
03	223	21.8		09.5	46	52.1	15.0		1	03.7	9.3	54.3	54	04	51	05	32	06	08	17	51	18	12	18	34	18	56
04	238	22.0		10.5	61	26.1	15.1		0	54.4	9.3	54.3	56	04	47	05	31	06	08	17	52	18	12	18	32	18	52
05	253	22.2		11.5	76	00.2	15.0		0	45.1	9.4	54.2	58	04	42	05	29	06	08	17	53	18	11	18	29	18	48
06	268	22.4	N	1	12.5	90	34.2	15.1 N	0	35.7	9.3	54.2	S 60	04	37	05	27	06	08	17	55	18	10	18	26	18	44
07	283	22.5		13.5	105	08.3	15.0		0	26.4	9.4	54.2	Lat.	Sunset	Twilight		Moonset										
08	298	22.7		14.5	119	42.3	15.1		0	17.0	9.3	54.2			Civil	Naut.	22	23	24	25							
09	313	22.9		15.4	134	16.4	15.1	N	0	07.7	9.4	54.2															
10	328	23.1		16.4	148	50.5	15.1	S	0	01.7	9.3	54.2															
11	343	23.3		17.4	163	24.6	15.1		0	11.0	9.3	54.2	N 72	18	35	19	45	21	21	06	08	06	04	05	59	05	55
12	358	23.5	N	1	18.4	177	58.7	15.1 S	0	20.3	9.4	54.2	N 70	18	32	19	34	20	57	06	03	06	03	06	04	06	04
13	13	23.7		19.4	192	32.8	15.1		0	29.7	9.3	54.2	68	18	29	19	26	20	39	05	58	06	03	06	07	06	12
14	28	23.9		20.4	207	06.9	15.1		0	39.0	9.3	54.2	66	18	27	19	19	20	25	05	54	06	02	06	10	06	19
15	43	24.1		21.3	221	41.0	15.2		0	48.3	9.3	54.2	64	18	26	19	14	20	13	05	51	06	02	06	13	06	24
16	58	24.3		22.3	236	15.2	15.1		0	57.6	9.3	54.2	62	18	24	19	09	20	04	05	48	06	01	06	15	06	29
17	73	24.4		23.3	250	49.3	15.1		1	06.9	9.3	54.2	60	18	23	19	05	19	56	05	45	06	01	06	17	06	33
18	88	24.6	N	1	24.3	265	23.4	15.2 S	1	16.2	9.3	54.1	N 58	18	22	19	01	19	49	05	43	06	01	06	19	06	37
19	103	24.8		25.3	279	57.6	15.1		1	25.5	9.3	54.1	56	18	21	18	58	19	43	05	41	06	01	06	20	06	40
20	118	25.0		26.3	294	31.7	15.2		1	34.8	9.3	54.1	54	18	20	18	55	19	38	05	39	06	00	06	22	06	43
21	133	25.2		27.2	309	05.9	15.1		1	44.1	9.3	54.1	52	18	19	18	53	19	33	05	37	06	00	06	23	06	46
22	148	25.4		28.2	323	40.0	15.1		1	53.4	9.2	54.1	50	18	18	18	51	19	29	05	36	06	00	06	24	06	49
23	163	25.6		29.2	338	14.1	15.2		2	02.6	9.3	54.1	45	18	17	18	46	19	21	05	32	06	00	06	27	06	54
24 00	178	25.8	N	1	30.2	352	48.3	15.2 S	2	11.9	9.2	54.1	N 40	18	15	18	43	19	14	05	29	05	59	06	29	06	59
01	193	26.0		31.2	7	22.5	15.1		2	21.1	9.3	54.1	35	18	14	18	40	19	09	05	27	05	59	06	31	07	03
02	208	26.1		32.2	21	56.6	15.2		2	30.4																	

ALTITUDE CORRECTION TABLES 0°-35°— MOON

App. Alt.	0°-4°		5°-9°		10°-14°		15°-19°		20°-24°		25°-29°		30°-34°		App. Alt.
	Corr ⁿ		Corr ⁿ		Corr ⁿ		Corr ⁿ		Corr ⁿ		Corr ⁿ		Corr ⁿ		
00	34.5		58.2		62.1		62.8		62.2		60.8		58.9		
10	36.5		58.5		62.2		62.8		62.2		60.8		58.8		
20	38.3		58.7		62.2		62.8		62.1		60.7		58.8		
30	40.0		58.9		62.3		62.8		62.1		60.7		58.7		
40	41.5		59.1		62.3		62.8		62.0		60.6		58.6		
50	42.9		59.3		62.4		62.7		62.0		60.6		58.5		
00	44.2	1	59.5	6	62.4	11	62.7	16	62.0	21	60.5	26	58.5	31	
10	45.4		59.7		62.4		62.7		61.9		60.4		58.4		
20	46.5		59.9		62.5		62.7		61.9		60.4		58.3		
30	47.5		60.0		62.5		62.7		61.9		60.3		58.2		
40	48.4		60.2		62.5		62.7		61.8		60.3		58.2		
50	49.3		60.3		62.6		62.7		61.8		60.2		58.1		
00	50.1	2	60.5	7	62.6	12	62.7	17	61.7	22	60.1	27	58.0	32	
10	50.8		60.6		62.6		62.6		61.7		60.1		57.9		
20	51.5		60.7		62.6		62.6		61.6		60.0		57.8		
30	52.2		60.9		62.7		62.6		61.6		59.9		57.8		
40	52.8		61.0		62.7		62.6		61.6		59.9		57.7		
50	53.4		61.1		62.7		62.6		61.5		59.8		57.6		
00	53.9	3	61.2	8	62.7	13	62.5	18	61.5	23	59.7	28	57.5	33	
10	54.4		61.3		62.7		62.5		61.4		59.7		57.4		
20	54.9		61.4		62.7		62.5		61.4		59.6		57.4		
30	55.3		61.5		62.8		62.5		61.3		59.5		57.3		
40	55.7		61.6		62.8		62.4		61.3		59.5		57.2		
50	56.1		61.6		62.8		62.4		61.2		59.4		57.1		
00	56.4	4	61.7	9	62.8	14	62.4	19	61.2	24	59.3	29	57.0	34	
10	56.8		61.8		62.8		62.4		61.1		59.3		56.9		
20	57.1		61.9		62.8		62.3		61.1		59.2		56.9		
30	57.4		61.9		62.8		62.3		61.0		59.1		56.8		
40	57.7		62.0		62.8		62.3		61.0		59.1		56.7		
50	58.0		62.1		62.8		62.2		60.9		59.0		56.6		
HP	L	U	L	U	L	U	L	U	L	U	L	U	L	U	HP
54.0	0.3	0.9	0.3	0.9	0.4	1.0	0.5	1.1	0.6	1.2	0.7	1.3	0.9	1.5	54.0
54.3	0.7	1.1	0.7	1.2	0.8	1.2	0.8	1.3	0.9	1.4	1.1	1.5	1.2	1.7	54.3
54.6	1.1	1.4	1.1	1.4	1.1	1.4	1.2	1.5	1.3	1.6	1.4	1.7	1.5	1.8	54.6
54.9	1.4	1.6	1.5	1.6	1.5	1.6	1.6	1.8	1.6	1.8	1.8	1.9	1.9	2.0	54.9
55.2	1.8	1.8	1.8	1.8	1.9	1.8	1.9	1.9	2.0	2.0	2.1	2.1	2.2	2.2	55.2
55.5	2.2	2.0	2.2	2.0	2.2	2.1	2.3	2.1	2.4	2.2	2.4	2.3	2.5	2.4	55.5
55.8	2.6	2.2	2.6	2.2	2.6	2.2	2.7	2.3	2.7	2.4	2.8	2.4	2.9	2.5	55.8
56.1	3.0	2.4	3.0	2.5	3.0	2.5	3.0	2.5	3.1	2.6	3.1	2.6	3.2	2.7	56.1
56.4	3.3	2.7	3.4	2.7	3.4	2.7	3.4	2.7	3.4	2.8	3.5	2.8	3.5	2.9	56.4
56.7	3.7	2.9	3.7	2.9	3.8	2.9	3.8	2.9	3.8	3.0	3.8	3.0	3.9	3.0	56.7
57.0	4.1	3.1	4.1	3.1	4.1	3.1	4.1	3.1	4.2	3.2	4.2	3.2	4.2	3.2	57.0
57.3	4.5	3.3	4.5	3.3	4.5	3.3	4.5	3.3	4.5	3.3	4.5	3.4	4.6	3.4	57.3
57.6	4.9	3.5	4.9	3.5	4.9	3.5	4.9	3.5	4.9	3.5	4.9	3.5	4.9	3.6	57.6
57.9	5.3	3.8	5.3	3.8	5.2	3.8	5.2	3.7	5.2	3.7	5.2	3.7	5.2	3.7	57.9
58.2	5.6	4.0	5.6	4.0	5.6	4.0	5.6	4.0	5.6	3.9	5.6	3.9	5.6	3.9	58.2
58.5	6.0	4.2	6.0	4.2	6.0	4.2	6.0	4.2	6.0	4.1	5.9	4.1	5.9	4.1	58.5
58.8	6.4	4.4	6.4	4.4	6.4	4.4	6.3	4.4	6.3	4.3	6.3	4.3	6.2	4.2	58.8
59.1	6.8	4.6	6.8	4.6	6.7	4.6	6.7	4.6	6.7	4.5	6.6	4.5	6.6	4.4	59.1
59.4	7.2	4.8	7.1	4.8	7.1	4.8	7.1	4.8	7.0	4.7	7.0	4.7	6.9	4.6	59.4
59.7	7.5	5.1	7.5	5.0	7.5	5.0	7.5	5.0	7.4	4.9	7.3	4.8	7.2	4.8	59.7
60.0	7.9	5.3	7.9	5.3	7.9	5.2	7.8	5.2	7.8	5.1	7.7	5.0	7.6	4.9	60.0
60.3	8.3	5.5	8.3	5.5	8.2	5.4	8.2	5.4	8.1	5.3	8.0	5.2	7.9	5.1	60.3
60.6	8.7	5.7	8.7	5.7	8.6	5.7	8.6	5.6	8.5	5.5	8.4	5.4	8.2	5.3	60.6
60.9	9.1	5.9	9.0	5.9	9.0	5.9	8.9	5.8	8.8	5.7	8.7	5.6	8.6	5.4	60.9
61.2	9.5	6.2	9.4	6.1	9.4	6.1	9.3	6.0	9.2	5.9	9.1	5.8	8.9	5.6	61.2
61.5	9.8	6.4	9.8	6.3	9.7	6.3	9.7	6.2	9.5	6.1	9.4	5.9	9.2	5.8	61.5

DIP			
Ht. of Eye	Corr ⁿ	Ht. of Eye	Corr ⁿ
m		ft.	
2.4	-2.8	8.0	9.5
2.6	-2.9	8.6	9.9
2.8	-3.0	9.2	10.3
3.0	-3.1	9.8	10.6
3.2	-3.2	10.5	11.0
3.4	-3.3	11.2	11.4
3.6	-3.4	11.9	11.8
3.8	-3.5	12.6	12.2
4.0	-3.6	13.3	12.6
4.3	-3.7	14.1	13.0
4.5	-3.8	14.9	13.4
4.7	-3.9	15.7	13.8
5.0	-4.0	16.5	14.2
5.2	-4.1	17.4	14.7
5.5	-4.2	18.3	15.1
5.8	-4.3	19.1	15.5
6.1	-4.4	20.1	16.0
6.3	-4.4	21.0	16.5
6.6	-4.5	22.0	16.9
6.9	-4.6	22.9	17.4
7.2	-4.7	23.9	17.9
7.5	-4.8	24.9	18.4
7.9	-4.9	26.0	18.8
8.2	-5.0	27.1	19.3
8.5	-5.1	28.1	19.8
8.8	-5.2	29.2	20.4
9.2	-5.3	30.4	20.9
9.5	-5.4	31.5	21.4

MOON CORRECTION TABLE

The correction is in two parts; the first correction is taken from the upper part of the table with argument apparent altitude, and the second from the lower part, with argument HP, in the same column as that from which the first correction was taken. Separate corrections are given in the lower part for lower (L) and upper (U) limbs. All corrections are to be added to apparent altitude, but 30' is to be subtracted from the altitude of the upper limb.

For corrections for pressure and temperature see page A4.

For bubble sextant observations ignore dip, take the mean of upper and lower limb corrections and subtract 15' from the altitude.

App. Alt. = Apparent altitude
= Sextant altitude corrected for index error and dip.

Figure 1908b. Altitude correction tables 0° - 35° from the Nautical Almanac for the Moon.

throughout the year.

First, record the GHA of the Moon for 21-00-00 on March 22, 2016, from the daily pages of the *Nautical Almanac*. The increment correction is done as in the previous examples. In this case, it is 15.3' because the sight was taken one minute and four seconds after the hour. From the daily page, record also the v correction factor, it is +15.0. The v correction factor for the Moon is always positive. To obtain the v correction, go to the tables of increments and corrections. In the 1 minute table in the v or d correction columns locate the correction that corresponds to $v = 15.0'$. The table yields a correction of +0.4'. Adding this correction to the tabulated GHA and increment gives the final GHA as $319^{\circ} 43.9'$.

Finding the Moon's declination is similar to finding the declination for the Sun or stars. The tabulated declination and the d factor come from the *Nautical Almanac's* daily pages. Go to the daily pages for March 22, 2016; extract the Moon's declination and d factor.

Record the declination and d correction and go to the increment and correction pages to extract the proper correction for the given d factor. In this case, go to the correction page for 1 minute. The correction corresponding to a d factor of -9.4 is -0.2'. It is important to extract the correction with the correct algebraic sign. The d correction may be positive or negative depending on whether the Moon's declination value is increasing or decreasing in the interval covered by the d factor. In this case, the Moon's declination value at 21-00-00 GMT on 22 March was $N 01^{\circ} 59.8'$; at 22-00-00 on the same date the Moon's declination was $N 01^{\circ} 50.4'$. Therefore, since the declination value was decreasing over this period, the d correction is negative. Do not assume to determine the sign of this correction by noting the trend in the d factor. For this problem, had the d factor for 21-00-00 been a value more than 22, it **would not indicate** that the d correction should be positive. Remember that the d factor is analogous to an interpolation factor; it provides a correction to declination. Therefore, the trend in declination values, not the trend in d values, controls the sign of the d correction. Combine the tabulated declination and the d correction factor to determine the true declination. In this case, the Moon's true declination is $N 01^{\circ} 59.6'$.

Having obtained the Moon's GHA and declination, calculate LHA and determine the assumed latitude. Enter the *Sight Reduction Table* with the LHA, assumed latitude, and calculated declination. Calculate the intercept and azimuth in the same manner used for star and Sun sights. (Note, for this example a DR was not provided, so these last steps are not shown on the strip form).

1909. Reducing a Planet Sight

There are four navigational planets: Venus, Mars, Jupiter, and Saturn. Reducing a planet sight is similar to reducing a Sun or star sight, but there are a few important

differences. This section will cover the procedure for determining h_o , the GHA and the declination for a planet sight.

On March 09, 2016, at 08-58-34 GMT, under standard meteorological conditions, the navigator takes a sight of Mars. H_s is $29^{\circ} 43.0'$. The height of eye is 68 feet, and the index correction is +0.2'. Determine h_o , GHA, and declination for Mars. A completed strip form showing the values from this example is shown in Figure 1907a.

The values on the filled-in strip form demonstrate the similarity between reducing planet sights and reducing sights of the Sun and stars. Calculate and apply the index and dip corrections exactly as for any other sight. Take the resulting apparent altitude and enter the altitude correction table for the stars and planets on the inside front cover of the *Nautical Almanac*.

In this case, the altitude correction for $29^{\circ} 35.2'$ results in a correction of -1.7'. The additional correction for refraction is not applicable because the sight was taken at standard temperature and pressure; the horizontal parallax correction is not applicable to a planet sight, only for the Moon. All that remains is the correction specific to Mars or Venus. The altitude correction table on the inside front cover of the *Nautical Almanac* also contains this correction; once again see Figure 1906c. Its magnitude is a function of the body sighted (Mars or Venus), the time of year, and the body's apparent altitude. Entering this table with the data for this problem yields a correction of +0.1'. Applying these corrections to h_a results in an h_o of $29^{\circ} 33.6'$.

Determine the planet's GHA in the same manner as with the Sun. That is, extract the tabular GHA for the hour the sight was taken ($48^{\circ} 08.6'$). Then determine the incremental addition for the minutes and seconds after the hour from the Increments and Corrections table in the back of the *Nautical Almanac* ($14^{\circ} 38.5'$). The only difference between determining the Sun's GHA and a planet's GHA lies in applying the v correction. Recall that the v correction was also needed for the Moon. As mentioned earlier, the v correction is needed because the Moon and planets' motion are not close to uniform throughout the year.

Find the v factor at the bottom of the planets' GHA columns on the daily pages of the *Nautical Almanac*; see Figure 1906b. For Mars on March 09, 2016, the v factor is 1.5. If no algebraic sign precedes the v factor, add the resulting correction to the tabulated GHA. Subtract the resulting correction only when a negative sign precedes the v factor. Entering the v or d correction table corresponding to 58 minutes yields a correction of 1.5'. Remember, because no sign preceded the v factor on the daily pages, add this correction to the tabulated GHA. The final GHA is $62^{\circ} 48.6'$.

Read the tabulated declination directly from the daily pages of the *Nautical Almanac*; in our example it is $S 19^{\circ} 10.7'$. The d correction factor is listed at the bottom of the planet column; in this case, the factor is 0.2. Note the trend in the declination values for the planet; if they are increasing around the time the sight was taken, the correction factor is positive. If the planet's declination value is de-

creasing around this time, the correction factor is negative. Next, enter the v or d correction table corresponding to 58 minutes and extract the correction for a d factor of 0.2. The correction in this case is +0.2'. The true declination is S 19° 10.9'.

From this point, reducing a planet sight is exactly the same as reducing a Sun sight. Having obtained the planet's

GHA and declination, the navigator can calculate LHA and determine the assumed latitude. Enter the Sight Reduction Table with the LHA, assumed latitude, and true declination. Calculate the intercept and azimuth in the same manner used for star and Sun sights. (Note, for this example a DR was not provided, so these last steps are not shown on the strip form).

MERIDIAN PASSAGE

This section covers determining both latitude and longitude at the meridian passage of the Sun, or Local Apparent Noon (LAN). Latitude at LAN is a special case of the navigational triangle where the Sun is on the observer's meridian and thus the triangle becomes a straight north/south line. Should the navigator wish to plot the resulting LOP, it would be a straight east/west line running along the navigator's latitude. However, no complete sight reduction is necessary; the navigator need only to combine the Sun's zenith distance and its declination according to the rules discussed below. A new strip form, different from the one used in a sight reduction, is usually used (see Figure 1910).

Longitude at LAN is a function of the time elapsed since the Sun passed the Greenwich meridian. The navigator must determine the time of LAN and calculate the GHA of the Sun at that time. The following examples demonstrate determining latitude and longitude at LAN.

1910. Latitude at Meridian Passage of the Sun (Local Apparent Noon)

At 1208 ZT, March 09, 2016, a vessel's DR position is L 39° 49.0'N and λ 044° 33.0' W. The ship is on course 045°T at a speed of ten knots. (1) Calculate the first and second estimates of Local Apparent Noon. (2) The navigator actually observes LAN at 12-08-04 zone time. The sextant altitude at LAN is 45° 54.0'. The index correction is +0.2' and the height of eye is 68 feet. Determine the vessel's latitude. A completed strip form showing the values from this example is shown in Figure 1910.

First, determine the time of meridian passage from the daily pages of the Nautical Almanac. It is found in the lower right corner of the right hand daily pages in Figure 1907b. In this case, the meridian passage for March 09, 2016, is 1210. That is, the Sun crosses the central meridian of the time zone at 1210 ZT. Next, determine the vessel's DR longitude for the time of meridian passage. In this case, the vessel's 1208 DR longitude is 044° 33.0' W. Determine the time zone in which this DR longitude falls and record the longitude of that time zone's central meridian. In this case, the central meridian is 45° W. Enter the Conversion of Arc to Time table in the *Nautical Almanac* (page i, near the back) with the difference between the DR longitude and the central meridian longitude. The conversion for 27' of arc is 1^m 48^s, which can be rounded to 2^m of time. Sum these two

times. If the DR position is east of the central meridian (as it is in this case), subtract this time from the time of tabulated meridian passage. If the longitude difference is to the west of the central meridian, add this time to the tabulated meridian passage. In this case, the DR position is east of the central meridian. Therefore, subtract 2 minutes from 1210, the tabulated time of meridian passage. The estimated time of LAN is 12-08-00 ZT.

This first estimate for LAN took into account the vessel's movement. Therefore, it is unnecessary to conduct second estimate of LAN.

Solving for latitude requires that the navigator calculate two quantities: the Sun's declination and the Sun's zenith distance. First, calculate the Sun's true declination at LAN. The problem states that LAN is observed at 12-08-04. (Determining the exact time of LAN is covered in Section 1911.) Enter the time of observed LAN and add the correct zone description to determine GMT. Determine the Sun's declination in the same manner as in the sight reduction problem in Section 1906. In this case, the tabulated declination was S 4° 10.0', and d is -1.0'; the d correction (from the increments and corrections table) is -0.1'. The true declination, therefore, is S 4° 09.9'.

Next, calculate zenith distance. Recall from Chapter 17 - *Navigational Astronomy* that zenith distance is simply 90° - observed altitude, h_o . Therefore, correct h_s to obtain h_a ; then correct h_a to obtain h_o . This is done the same way as was done for reducing a Sun sight in Section 1907. Then, subtract h_o from 90° to determine the zenith distance. For our example, after applying the appropriate corrects, h_o is 46° 01.5', and the zenith distance is 43° 58.5'.

Your latitude is determined by applying the Sun's true declination to the zenith distance using the following rules:

- If DR lat and Dec (Sun) are same (e.g., both North or both South), then ADD
- If DR lat and Dec (Sun) are contrary (e.g., one North, one South), then SUBTRACT
- If DR lat and Dec (Sun) are same, and Dec is greater, then SUBTRACT

In this case, the DR latitude is N 39° 49.0' and the Sun's declination is S 4° 09.9', which are contrary. Therefore, subtract the true declination from the zenith distance. The latitude for our example is N 39° 48.6'.

1911. Longitude at Meridian Passage

OPNAV 3530/35 (4-73) LAN		NAVIGATION WORKBOOK OPNAV 3530/1 (Rev. 7-74)	
Date	DATE/DR POST 9 Mar 2016 39° 49.0' N, 044° 33.0' W		
DRλ	044° 33.0' W		
STD Meridian	045° W		
dλ (arc)	27.0' E		
Dλ (time)	-2m (rounded)		
LMT Mer Pass	1210		
ZT LAN (1 st Est.)	1208		
Rev DRλ	—		
STD Meridian	—		
dλ (arc)	—		
dλ (time)	—		
LMT Mer Pass	—		
ZT LAN (2 nd est)	—		
LAT BY LAN:			
ZT LAN (OBS)	12-08-04		
ZD	+3		
GMT	15-08-04		
Tab Dec	S 4° 10.0'		
d# / d Corr	-1.0 / -0.1'		
True Dec	S 4° 9.9'		
IC	+0.2'		
D	-8.0'		
Sum	-7.8'		
hs	45° 54.0'		
ha	45° 46.2'		
Alt Corr	+15.3'		
Ho	46° 1.5'		
89° 60'	89° 60.0'		
HO (-)	-46° 1.5'		
Z Dist	43° 58.5'		
True Dec	S 4° 9.9'		
LAT	N 39° 48.6'		
Time			
			
Sounding			
Signature			

Figure 1910. Sight reduction strip form for Local Apparent Noon (LAN).

Determining a vessel's longitude at LAN is straightforward. In the western hemisphere, the Sun's GHA at LAN equals the vessel's longitude. In the eastern hemisphere, subtract the Sun's GHA from 360° to determine longitude. The difficult part lies in determining the precise moment of meridian passage.

Determining the time of meridian passage presents a problem because the Sun appears to hang for a finite time at its local maximum altitude. Therefore, noting the time of maximum sextant altitude is not sufficient for determining the precise time of LAN. Two methods are available to obtain LAN with a precision sufficient for determining longitude: (1) the graphical method and (2) the calculation method. The graphical method is discussed first below.

For about 30 minutes before the estimated time of LAN, measure and record several sextant altitudes and their corresponding times. See Figure 1911. Continue taking sights for about 30 minutes after the Sun has descended from the maximum recorded altitude. Increase the sighting frequency near the meridian passage. One sight every 20-30 seconds should yield good results near meridian passage; less frequent sights are required before and after.

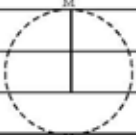
Plot the resulting data on a graph of sextant altitude versus time and draw a fair curve through the plotted data. Next, draw a series of horizontal lines across the curve formed by the data points. These lines will intersect the faired curve at two different points. The x coordinates of the points where these lines intersect the faired curve represent the two different times when the Sun's altitude was equal (one time when the Sun was ascending; the other time when the Sun was descending). Draw three such lines, and ensure the lines have sufficient vertical separation. For each line, average the two times where it intersects the faired curve. Finally, average the three resulting times to obtain a final value for the time of LAN. From the *Nautical Almanac*, determine the Sun's GHA at that time; this is your longitude in the western hemisphere. In the eastern hemisphere, subtract the Sun's GHA from 360° to determine longitude. For a quicker but less exact time, simply drop a perpendicular from the apex of the curve and read the time along the time scale.

The second method of determining LAN is similar to the first. Estimate the time of LAN as discussed above, Measure and record the Sun's altitude as the Sun approaches its maximum altitude. As the Sun begins to descend, set the sextant to correspond to the altitude recorded just before the Sun's reaching its maximum altitude. Note the time when the Sun is again at that altitude. Average the two times. Repeat this procedure with two other altitudes recorded before LAN, each time presetting the sextant to those altitudes and recording the corresponding times that the Sun, now on its descent,

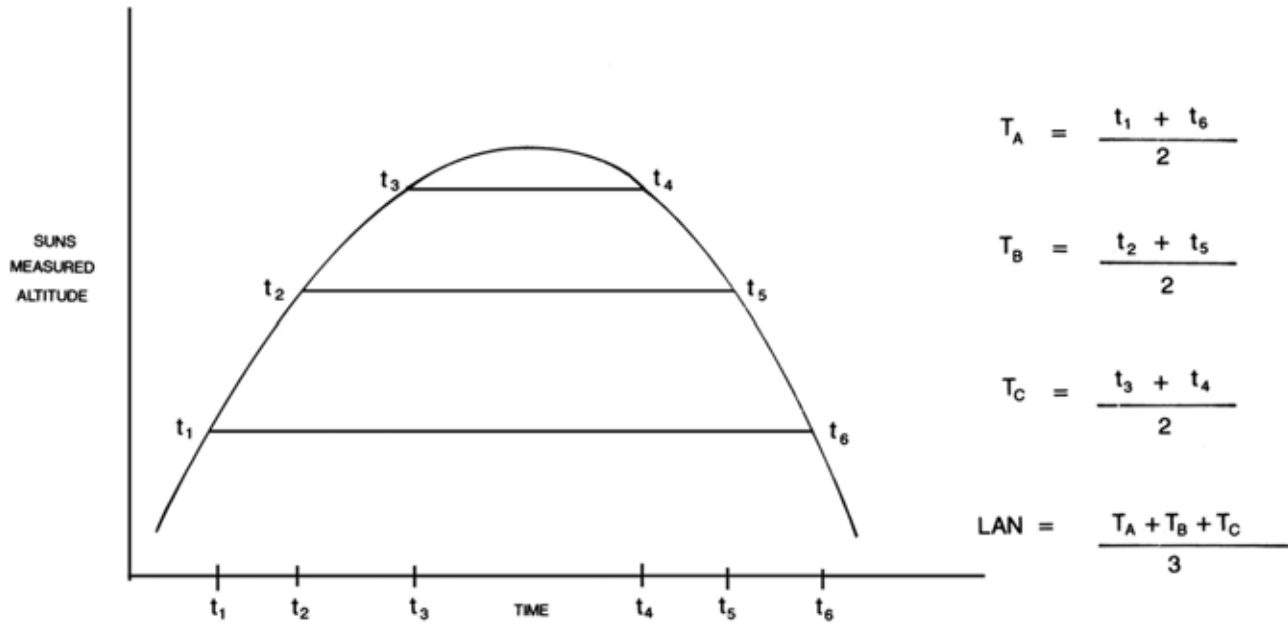

Figure 1911. Time of LAN.

passes through those altitudes. Average these corresponding times. Take a final average among the three averaged times; the result will be the time of

meridian passage. Determine the vessel's longitude by determining the Sun's GHA at the exact time of LAN.

LATITUDE BY POLARIS

1912. Latitude by Polaris

Because Polaris is always within about 1° of the North Pole, the altitude of Polaris, with a few minor corrections, equals the latitude of the observer. This relationship makes Polaris an extremely important navigational star in the northern hemisphere.

The corrections are necessary because over the course of 24 hours, Polaris appears to move in a small circle around the pole. When Polaris is at the exact same altitude as the pole, the correction is zero. When on the observer's meridian, that is at upper or lower culmination, the corrections are maximum. A special table, The Polaris Table, in the *Nautical Almanac* is used to determine the correction. The following example illustrates converting a Polaris sight to latitude. A new strip form, different from the one used in a sight reduction and LAN, is often used (see Figure 1912a).

At 23-18-56 GMT, on March 22, 2016, at DR Lat. 40°

$46.0' N$, $\lambda = 043^\circ 22.0' W$, the observed altitude of Polaris (h_o) is $40^\circ 52.1'$. Find the vessel's latitude (see Figure 2310c).

To solve this problem, use the equation:

$$\text{Latitude} = h_o - 1^\circ + A_0 + A_1 + A_2$$

where h_o is the sextant altitude (h_s) corrected as in any other star sight; 1° is a constant; and A_0 , A_1 , and A_2 are correction factors from the Polaris tables found on pages 274-276 of the *Nautical Almanac* (see Figure 1912b). These three correction factors are always positive. One needs the following information to enter the tables: LHA of Aries, DR latitude, and the month of the year. Therefore, LHA of Aries is determined similarly to the LHA of any other object. That is, first determine the GHA, then either add or subtract the DR longitude to compute LHA. Determining the GHA is done as with any other body. Extract the tabular

OPNAV 3530/40 (4-73) LAT BY POLARIS		NAVIGATION WORKBOOK OPNAV 3530/1 (Rev. 7-74)	
Date	DATE/DR POSIT 22 Mar 2016 40° 46' N, 043° 22.0' W		
Body	Polaris		
GMT	23-18-56		
IC			
D			
Sum			
Hs			
Ha			
Alt Corr			
Add'l Corr			
Ho	40° 52.1'		
GHA _γ (h)	165° 52.3'		
Incr (m/s)	4° 44.8'		
Total GHA _γ	170° 37.1'		
+ 360°	—		
DRλ (+E -W)	-43° 22.0'		
LHA _γ	127° 15.1'		
A ₀	54.9'		
A ₁	0.5'		
A ₂	0.9'		
Sum	56.3'		
1° 00' (-)	-1° 00.0'		
Total Corr	-3.7'		
Ho	40° 52.1'		
LAT	N 40° 48.4'		
Time			
			
Sounding			
Signature			

Figure 1912a. Sight reduction strip form for longitude by Polaris.

THE DAY'S WORK IN CELESTIAL NAVIGATION

1913. Celestial Navigation Daily Routine

The navigator need not follow the entire celestial routine if celestial navigation is not the primary navigation method. It is appropriate to use only the steps of the celestial day's work that are necessary to provide a meaningful

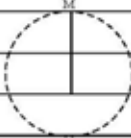
GHA for the hour the sight was taken (165° 52.3'). Then determine the incremental addition for the minutes and seconds after the hour from the Increments and Corrections table in the back of the *Nautical Almanac* (4° 44.8'). The total GHA of Aries is 170° 37.1'. As described above, LHA is GHA - λ for west longitudes and GHA + λ for east longitudes. Because our example DR is in the western hemisphere, subtract the DR longitude from the GHA to obtain the LHA of Aries, 127° 15.1'.

Next, enter the Polaris table with the calculated LHA of Aries at the time of observation (127° 15.1'). The first correction, A₀, is a function solely of the LHA of Aries. Enter the table column indicating the proper range of LHA of Aries; in this case, enter the 120°-129° column. The numbers on the left hand side of the A₀ correction table represent the whole degrees of LHA Υ° ; interpolate to determine the proper A₀ correction. In this case, LHA Υ° was 127° 15.1'. The A₀ correction for LHA = 127° 54.7' and the A₀ correction for LHA = 128° is 55.4'. The A₀ correction for 127° 15.1' is 54.9'.

To calculate the A₁ correction, enter the A₁ correction table with the DR latitude, being careful to stay in the 120°-129° LHA column. There is no need to interpolate here; simply choose the latitude that is closest to the vessel's DR latitude. In this case, L is 40°N. The A₁ correction corresponding to an LHA range of 120°-129° and a latitude of 40°N is + 0.5'.

Finally, to calculate the A₂ correction factor, stay in the 120°-129° LHA Υ° column and enter the A₂ correction table. Follow the column down to the month of the year; in this case, it is March. The correction for March is + 0.9'.

Sum the corrections, remembering that all three are always positive (56.3'). Subtract 1° from the sum to determine the total correction (-3.7'), then apply the resulting value to the observed altitude of Polaris. The result is the vessel's latitude, N 40° 48.4'.

check on the primary fix source and maintain competency in celestial techniques.

The list of procedures below provides a complete daily celestial routine to follow. This sequence works equally well for all sight reduction methods, whether tabular, mathematical, computer program, or celestial navigation

POLARIS (POLE STAR) TABLES, 2016

FOR DETERMINING LATITUDE FROM SEXTANT ALTITUDE AND FOR AZIMUTH

LHA	120° -	130° -	140° -	150° -	160° -	170° -	180° -	190° -	200° -	210° -	220° -	230° -
ARIES	129°	139°	149°	159°	169°	179°	189°	199°	209°	219°	229°	239°
	<i>a</i> ₀	<i>a</i> ₀	<i>a</i> ₀	<i>a</i> ₀	<i>a</i> ₀	<i>a</i> ₀	<i>a</i> ₀	<i>a</i> ₀	<i>a</i> ₀	<i>a</i> ₀	<i>a</i> ₀	<i>a</i> ₀
0	0 49.9	0 56.8	1 03.8	1 10.6	1 17.0	1 22.9	1 28.1	1 32.3	1 35.6	1 37.8	1 38.7	1 38.5
1	50.6	57.5	04.5	11.3	17.7	23.5	28.5	32.7	35.9	37.9	38.8	38.4
2	51.3	58.2	05.2	11.9	18.3	24.0	29.0	33.1	36.1	38.0	38.8	38.3
3	52.0	58.9	05.9	12.6	18.9	24.6	29.5	33.4	36.4	38.2	38.8	38.2
4	52.7	0 59.6	06.6	13.2	19.5	25.1	29.9	33.8	36.6	38.3	38.8	38.1
5	0 53.4	1 00.3	1 07.2	1 13.9	1 20.1	1 25.6	1 30.3	1 34.1	1 36.8	1 38.4	1 38.8	1 38.0
6	54.0	01.0	07.9	14.5	20.7	26.1	30.8	34.4	37.0	38.5	38.8	37.8
7	54.7	01.7	08.6	15.2	21.2	26.6	31.2	34.7	37.2	38.6	38.7	37.7
8	55.4	02.4	09.3	15.8	21.8	27.1	31.6	35.0	37.4	38.6	38.7	37.5
9	56.1	03.1	09.9	16.4	22.4	27.6	32.0	35.3	37.6	38.7	38.6	37.3
10	0 56.8	1 03.8	1 10.6	1 17.0	1 22.9	1 28.1	1 32.3	1 35.6	1 37.8	1 38.7	1 38.5	1 37.1
Lat.	<i>a</i> ₁	<i>a</i> ₁	<i>a</i> ₁	<i>a</i> ₁	<i>a</i> ₁	<i>a</i> ₁	<i>a</i> ₁	<i>a</i> ₁	<i>a</i> ₁	<i>a</i> ₁	<i>a</i> ₁	<i>a</i> ₁
0	0.3	0.3	0.3	0.4	0.4	0.4	0.5	0.5	0.6	0.6	0.6	0.6
10	.4	.4	.4	.4	.4	.5	.5	.5	.6	.6	.6	.6
20	.4	.4	.4	.4	.5	.5	.5	.6	.6	.6	.6	.6
30	.5	.5	.5	.5	.5	.5	.5	.6	.6	.6	.6	.6
40	0.5	0.5	0.5	0.5	0.5	0.6	0.6	0.6	0.6	0.6	0.6	0.6
45	.6	.6	.6	.6	.6	.6	.6	.6	.6	.6	.6	.6
50	.6	.6	.6	.6	.6	.6	.6	.6	.6	.6	.6	.6
55	.7	.7	.7	.6	.6	.6	.6	.6	.6	.6	.6	.6
60	.7	.7	.7	.7	.7	.7	.6	.6	.6	.6	.6	.6
62	0.8	0.8	0.8	0.7	0.7	0.7	0.7	0.6	0.6	0.6	0.6	0.6
64	.8	.8	.8	.8	.7	.7	.7	.6	.6	.6	.6	.6
66	.8	.8	.8	.8	.8	.7	.7	.7	.6	.6	.6	.6
68	0.9	0.9	0.9	0.9	0.8	0.8	0.7	0.7	0.6	0.6	0.6	0.6
Month	<i>a</i> ₂	<i>a</i> ₂	<i>a</i> ₂	<i>a</i> ₂	<i>a</i> ₂	<i>a</i> ₂	<i>a</i> ₂	<i>a</i> ₂	<i>a</i> ₂	<i>a</i> ₂	<i>a</i> ₂	<i>a</i> ₂
Jan.	0.6	0.6	0.6	0.6	0.5	0.5	0.5	0.5	0.5	0.5	0.5	0.5
Feb.	.8	.7	.7	.7	.6	.6	.6	.5	.5	.5	.4	.4
Mar.	0.9	0.9	0.9	0.8	.8	.8	.7	.7	.6	.6	.5	.5
Apr.	1.0	1.0	1.0	1.0	0.9	0.9	0.9	0.8	0.8	0.7	0.6	0.6
May	0.9	1.0	1.0	1.0	1.0	1.0	1.0	0.9	0.9	0.9	.8	.7
June	.8	0.9	0.9	1.0	1.0	1.0	1.0	1.0	1.0	1.0	0.9	.9
July	0.7	0.7	0.8	0.8	0.9	0.9	1.0	1.0	1.0	1.0	1.0	0.9
Aug.	.5	.6	.6	.7	.7	.8	0.8	0.9	0.9	0.9	1.0	1.0
Sept.	.4	.4	.4	.5	.6	.6	.7	.7	.8	.8	0.9	0.9
Oct.	0.3	0.3	0.3	0.3	0.4	0.4	0.5	0.5	0.6	0.7	0.7	0.8
Nov.	.2	.2	.2	.2	.3	.3	.3	.4	.4	.5	.5	.6
Dec.	0.3	0.3	0.2	0.2	0.2	0.2	0.2	0.2	0.3	0.3	0.4	0.4
Lat.	AZIMUTH											
0	359.3	359.3	359.3	359.4	359.4	359.5	359.6	359.7	359.8	359.9	0.0	0.1
20	359.3	359.3	359.3	359.3	359.4	359.5	359.6	359.7	359.8	359.9	0.0	0.1
40	359.1	359.1	359.1	359.2	359.3	359.4	359.5	359.6	359.7	359.9	0.0	0.2
50	359.0	359.0	359.0	359.0	359.1	359.2	359.4	359.5	359.7	359.9	0.0	0.2
55	358.8	358.8	358.9	358.9	359.0	359.1	359.3	359.5	359.6	359.8	0.0	0.2
60	358.7	358.7	358.7	358.8	358.9	359.0	359.2	359.4	359.6	359.8	0.0	0.3
65	358.4	358.4	358.5	358.5	358.7	358.8	359.0	359.3	359.5	359.8	0.0	0.3

ILLUSTRATION
 On 2016 April 21 at
 23^h 18^m 56^s UT in longitude
 W 37° 14' the apparent altitude
 (corrected for refraction), *H*₀, of
Polaris was 49° 31'6

From the daily pages:		<i>H</i> ₀	49 31.6
GHA Aries (23 ^h)	195 26.5	<i>a</i> ₀ (argument 162° 57')	1 18.9
Increment (18 ^m 56 ^s)	4 44.8	<i>a</i> ₁ (Lat 50° approx.)	0.6
Longitude (west)	-37 14	<i>a</i> ₂ (April)	0.9
LHA Aries	162 57	Sum - 1° = Lat =	49 52.0

Figure 1912b. Excerpt from the Polaris Tables.

calculator. See Figure 1913 for an example of a typical day's celestial plot.

1. Before dawn, compute the time of morning twilight and plot the dead reckoning position for that time. (See

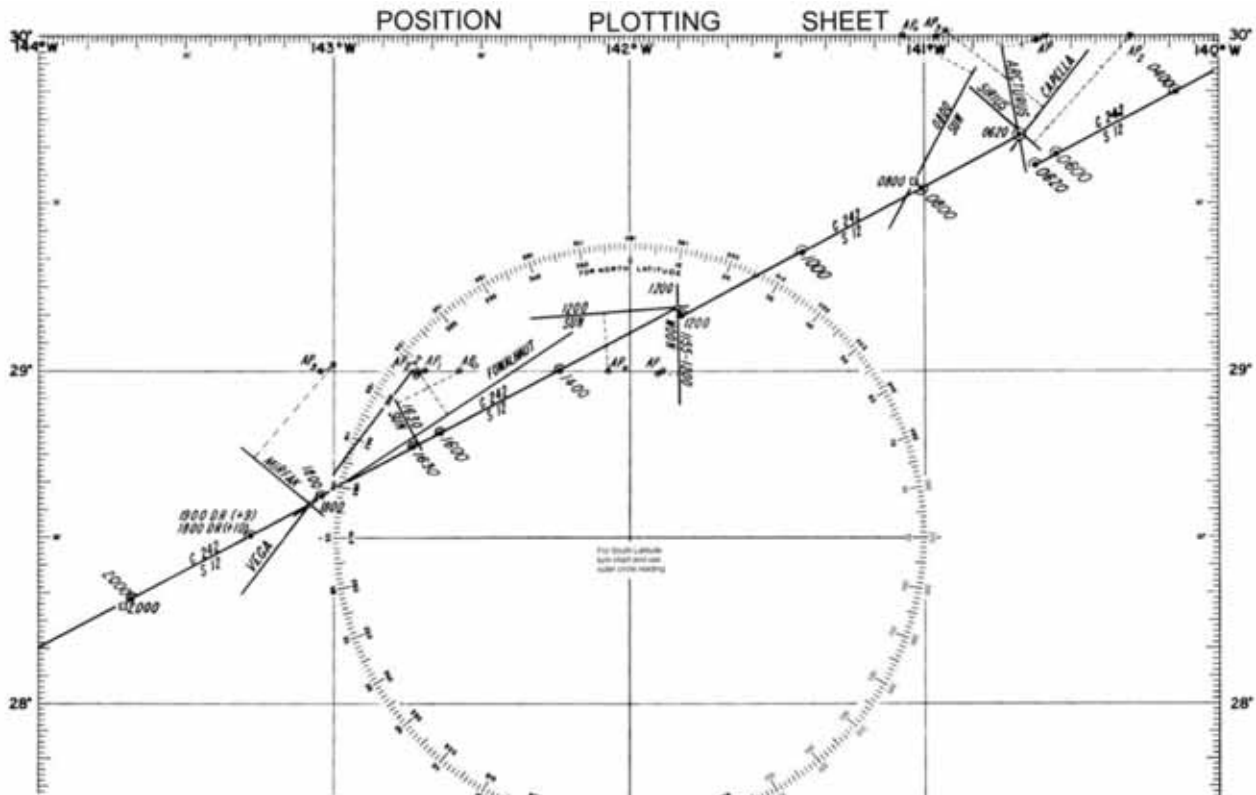

Figure 1913. Typical celestial plot at sea.

Chapter 21 The Almanacs - Section 2109 Finding Times of Sunrise and Sunset.)

2. At morning twilight, take and reduce celestial observations for a fix. At sunrise take an amplitude of the Sun to obtain gyro error. (See Chapter 19 Azimuths and Amplitudes.)

3. Mid-morning, compare the chronometer with UT to determine chronometer error using a radio time tick. (See Chapter 20 Time.)

4. Mid-morning, reduce a Sun sight for a morning Sun line. (See section 1907 in this chapter.)

5. Calculate an azimuth of the Sun to obtain gyro error, if no amplitude was taken at sunrise. (See Chapter 19 Azimuths and Amplitudes.)

6. At LAN, obtain a Sun line and advance the morning Sun line for the noon fix. Compute a longitude determined at LAN for an additional LOP. (See Section

1910 and Section 1911 in this chapter.)

7. Mid-afternoon, again take and reduce a Sun sight. This is primarily for use with an advanced noon Sun line, or with a Moon or Venus line if the skies are overcast during evening twilight.

8. Calculate an azimuth of the Sun to obtain gyro error at about the same time as the afternoon Sun observation. The navigator may replace this azimuth with an amplitude observation at sunset. (See Chapter 19 Azimuths and Amplitudes.)

9. During evening twilight, reduce celestial observations for a fix. (See Section 1906 in this chapter.)

10. Be alert at all times for the moon or brighter planets which may be visible during daylight hours for additional LOP's, and Polaris at twilight for a latitude line.

CHAPTER 20

INTRODUCTION TO INERTIAL NAVIGATION

INTRODUCTION

2000. Background

Inertial navigation is the process of measuring a craft's velocity, attitude, and displacement from a known start point through sensing the accelerations acting on it in known directions by means of devices that mechanize Newton's and Kepler's laws of motion (Section 1306), namely accelerometers and gyroscopes. Since these laws are expressed relative to inertial space (the fixed stars), the term "inertial" is applied to the process. **Inertial navigation systems (INS)** are used in a variety of military and civilian applications, including aircraft, spacecraft, rockets, and marine vessels. Development of the technology began in earnest in the U.S. following World War II. Since that time, inertial navigation system components have continuously grown both smaller and more accurate, while modern computers are able to quickly handle large numbers of computations.

Inertial navigation is described as "passive" because no energy is emitted to obtain information from an external source, and there is no need for continuous radio frequency reception from a fix source. Thus, inertial navigation is fundamentally different from other methods of navigation because it depends only on measurements made within the craft being navigated. However, additional navigation aids are often required to correct errors that develop in the system over time. These errors and navigation aids are discussed in Section 2015 through Section 2025.

Inertial navigation is often referred to as a sophisticated dead reckoning method because position is obtained by measuring displacements from a start point in accordance

with the motion of the craft.

2001. Basic Principle

The basic principle of inertial navigation is the measurement of the accelerations acting on a craft, and the double integration of these accelerations along known directions to obtain the displacement from the start point.

For example, if the indicated acceleration of the craft from rest is constant, velocity and distance traveled can be found from the equations:

$$v = at$$

and

$$s = 1/2 at^2$$

where a is the acceleration, v is the velocity, s is the distance, and t is the time. But these equations assume that acceleration is constant and cannot be used otherwise. For varying accelerations the following equations (using calculus notation) are needed:

$$v = \int a dt$$

$$s = \iint v dt$$

where \int denotes an integral (analogous to a summation) and dt denotes a very small increment of time.

SENSORS

2002. Sensors

Inertial sensors used in the mechanization of Newton's laws of motion, hereafter called the inertial navigator or inertial navigation system (INS), are gyroscopes and accelerometers. The gyroscopes sense angular orientation or motions of the vessel. The accelerometers sense the vessel's linear accelerations, which are changes in linear velocity. The inertial sensors are subject to all motions of the vessel in inertial space, including those that do not change the vessel's position or orientation on the earth, such

as the earth's rotation. Thus, it is necessary to apply certain corrections to the inertial motions (Section 2004) sensed in order to obtain just the motions of the inertial navigator with respect to the earth.

2003. Gyroscopes

At the very basic level, a gyroscope (or "gyro") is a device that can be used to detect and measure angular rotation. It is a key component of inertial navigators because it provides the information required to accurately

determine the orientation of the inertial sensors (gyroscopes and accelerometers) within inertial space. Without these devices, the navigation computer would be unable to correctly attribute acceleration forces to the x, y, and z axes. This would make accurate determination of ship velocity and position impossible.

One common configuration of gyros in an INS is that each gyroscope only senses rotation around a single axis. With three gyros mounted such that their input axes are mutually perpendicular, three-dimensional attitude control of the platform is obtained.

The classical gyroscope is a spinning mass gyroscope. Spinning mass gyros are still in use in specialty and high-accuracy applications; however, in many INSs, the spinning mass gyroscope has been replaced in recent decades with gyroscopes more suitable for a strapdown implementation (Section 2009). The predominant gyroscopes used in inertial navigators today fall into the class of gyroscopes using the principle of light (optical gyroscopes) and vibrating structure gyroscopes. Rather than directly measuring the change in angular orientation, these types of gyros measure the angular rate, from which orientation can be computed. The following discussions of these three classes of gyros are written to meet the needs of an introductory treatment of inertial navigation.

2004. Spinning Mass Gyroscopes

A simple spinning mass gyro consists of a rotating wheel or ball, which may be supported by a series of gimbals to allow for three degrees of freedom of movement. The principle of conservation of angular momentum states that a system will maintain its angular momentum as long as no external forces are applied to it. Thus, the mass of the gyroscope must maintain a constant angular momentum about its spin axis if no external forces are applied. Both the amplitude and direction of the angular momentum must be conserved. The spin axis, therefore, tends to maintain the same direction in inertial space. This property is called gyroscopic inertia or rigidity in space. This is the same property that keeps a children's spinning top or a moving bicycle upright.

If a rotational or couple force is applied to the spinning mass through the gyroscope's supports, an additional angular momentum is introduced. The gyroscope's orientation will change to include this along with its original angular momentum about the spin axis. This property of the gyroscope is called precession.

Precession causes the gyroscope to tend to align its spin axis with the axis of the applied torque (Figure 2004). If the axis of applied torque is designated as the input axis, then the precession of the gyroscope can be determined by rotating the spin axis into the input axis through the smaller angle. Using this nomenclature the axis of precession is often called the output axis. By measuring the displacement of the spinning mass about this output axis, the magnitude

of the torque acting about the input axis on the spinning mass can be inferred. In a gimbaled INS (Section 2009), a control system works to counter-rotate/counter-torque the platform or table to which the gyro is attached. The counter-rotation returns the gyro to its original (or correct) orientation and "nulls" out the gyro's report of rotation. This type of control system can be used to stabilize a platform at a given orientation regardless of ship's motion. In a strap-down INS, the measurement of precession is used to mathematically determine the platform's new orientation. See Figure 2004.

2005. Optical Gyroscopes

Optical gyros such as **ring laser gyros (RLG)** and **fiber optic gyros (FOG)** make use of the **Sagnac principle** to measure rate of angular rotation. To visualize how this principle is employed to measure rotation, one can imagine two light beams, one traveling clockwise (CW) and the other traveling counterclockwise (CCW) about a circular optical path, as shown in Figure 2005a. Both light beams leave from the same origin, point A, at the same time. If the circular path is then rotated, for example in the CCW direction so that the origin is now at point B, then the light beams traveling in the CW direction will now have a shorter optical path to return to the light source origin, while the CCW beam will now have a longer optical path. Because the speed of light is constant, the two light beams will continue to travel at the same speed despite this rotation, and the CW beam will arrive back at the origin before the CCW beam will. The amount of rotation can be calculated by measuring the difference in arrival time between the two light beams.

In practice, the difference in arrival time between the two beams is not measured directly. Rather, when the path is rotated, the two beams of light undergo a wavelength shift, meaning that the distance between points of maximum amplitude of the waves either shortens or lengthens. In the example above, the CCW beam would have a longer wavelength, and the CW beam would have a shorter wavelength. When the two beams recombine at the origin, the maximum and minimum points on the two waves are no longer aligned with each other. The misalignment creates an interference pattern from which the difference in the two wavelengths can be obtained. This calculation is used to determine the angle of rotation.

In an RLG, the circular path is replaced with a polygon path (often triangular), which is constructed using mirrors at each corner of the polygon (Figure 2005b). The pathway consists of a sealed channel which is filled with a mixture of gases that emit light when ionized. High voltage applied to electrodes in the channel ionizes the gas and causes lasing action. The lasing generates a standing light wave which is analogous to two counter-propagated light beams, and the change in wavelengths of the beams determines the rotation rate, as described above.

In a FOG, the laser is separate from the rotating chan-

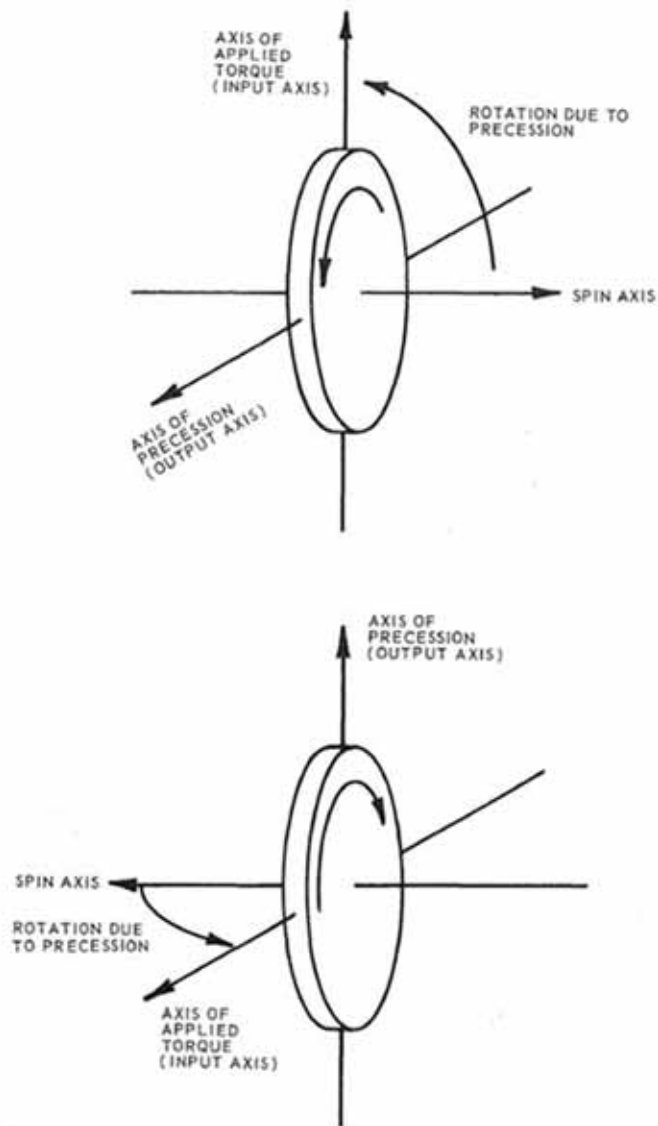

Figure 2004. Precession of a gyroscope.

nel. Two beams are injected in opposite directions into a coiled optical fiber (Figure 2005c), which may be more than a mile in total length. Again, the difference in wavelengths determines the rotation rate.

Optical gyros do not resist changes to their orientation the way spinning mass gyros do. However, they are still considered gyros due to their ability to sense rotation.

2006. Vibrating Structure Gyroscopes

The underlying principle of vibrating structure gyros is that when a vibrating object is rotated, the vibration will tend to continue in the same plane, rather than rotating with the object. In these gyros, the mass is generally driven to resonance (the mass's natural vibrating frequency, at which it will vibrate with maximum amplitude) by electrostatic

forces. When the object is rotated, the vibration patterns begin to precess around the axis of rotation, similar to the precession seen in spinning mass gyros (Section 2004). Several variations of vibrating structure gyroscopes exist; a few are described here.

A hemispherical resonator gyroscope (“wine-glass resonator”) is based on the rotation-sensing properties of a ringing wine glass. This gyro consists of a thin hemisphere, commonly made of quartz glass, anchored by a thin stem. Electrodes surrounding the shell provide the forces that drive the shell to resonance. This type of gyro is highly accurate, but requires precision manufacturing and sophisticated electronics to drive and sense the standing wave on the shell.

Tuning fork gyroscopes use a pair of test masses driven to resonate with equal amplitude but in opposite directions. Rotation can be determined by measuring their displace-

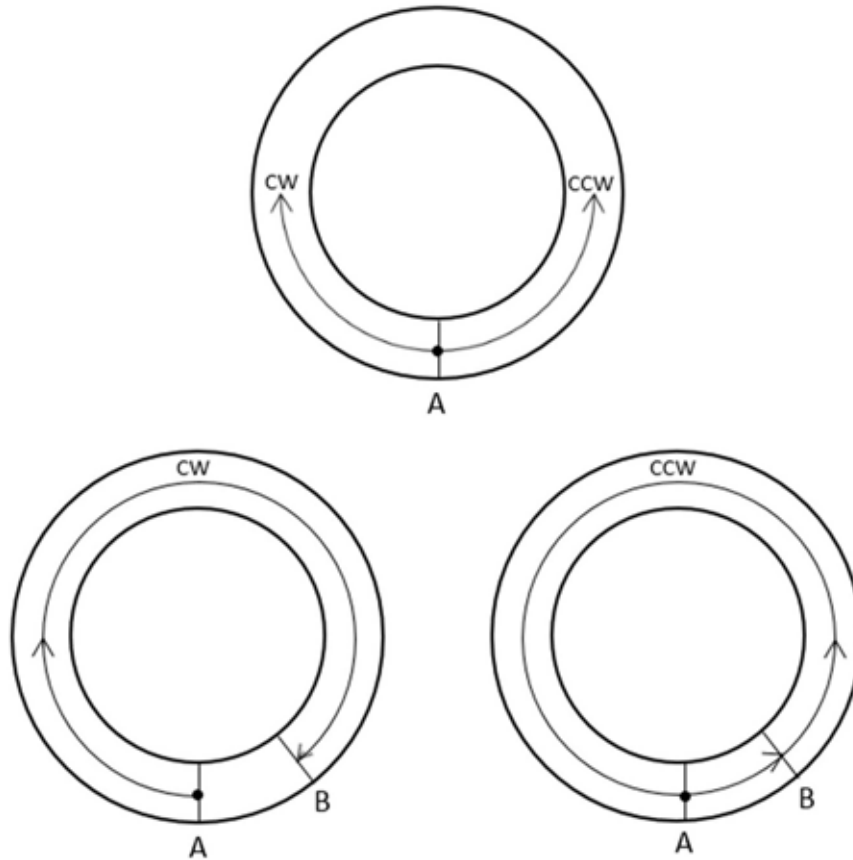

Figure 2005a. Illustration of the Sagnac principle in optical gyros. Courtesy of Michelle C. Greiner, Johns Hopkins University - Applied Physics Laboratory.

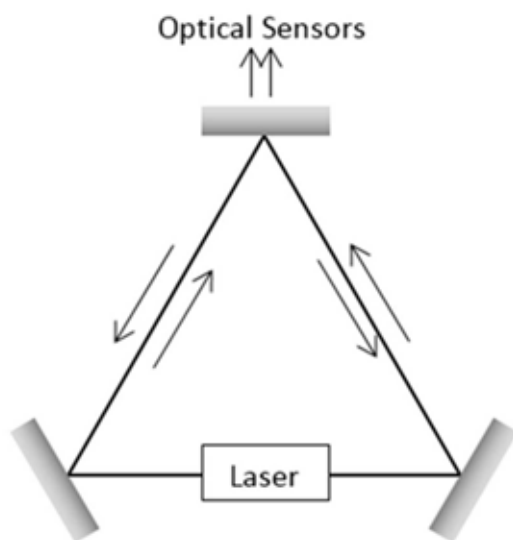

Figure 2005b. Ring Laser Gyro. Courtesy of Michelle C. Greiner, Johns Hopkins University - Applied Physics Laboratory.

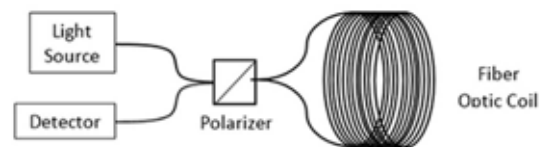

Figure 2005c. Fiber Optic Gyro. Courtesy of Michelle C. Greiner, Johns Hopkins University - Applied Physics Laboratory.

ment from the plane of oscillation.

In vibrating wheel gyroscopes, a disc vibrates around its center axis. Rotation around either of the other two axes (those in the same plane as the disc) causes the disc to tilt. This tilt can be measured by sensors under the disc.

Microelectromechanical systems (MEMS) employ vibrating structure gyros. These are small, relatively inexpensive gyros packaged as integrated circuits. Current technology has allowed these types of gyros to become commonplace, integrated into systems such as automobiles, smartphones, and video game controllers. However, their

use in navigation is limited to applications where GPS is nearly continuously available, due to the long-term error growth of the present technology.

2007. Accelerometers

Velocity is the linear rate of change of position. If the velocity is known it can be integrated with respect to time to determine the change in position. However, no external forces are required for movement at a constant velocity; therefore, constant velocity cannot be sensed or measured

with an inertial device.

A body at rest will remain at rest unless acted upon by an external force, and a body in motion will retain the motion unless acted upon by an external force. By measuring forces acting on a test mass, *changes* in velocity can be detected. This rate of change in velocity, called acceleration, is what accelerometers measure. Three accelerometers are mounted in an INS such that they sense accelerations along three mutually perpendicular axes.

In its simplest form, the accelerometer consists of a test mass, as shown in Figure 2007, constrained to measure accel-

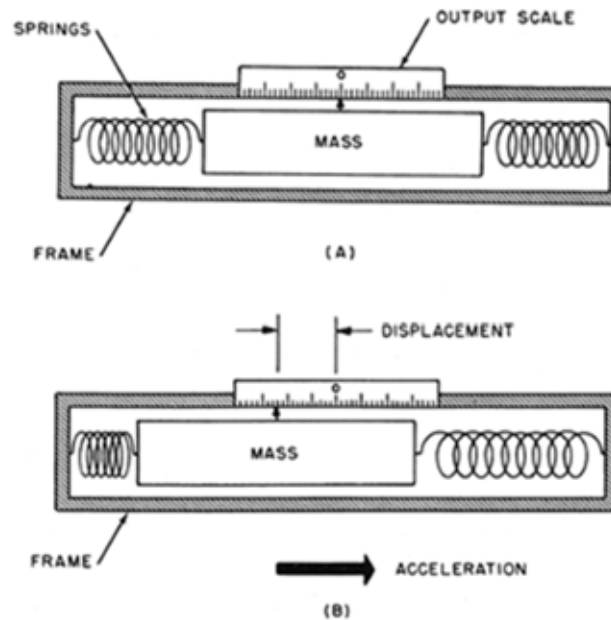

Figure 2007. Basic accelerometer.

erations in a particular direction (the sensitive axis) with a scale, or other appropriate device, to indicate its output. If the frame is accelerated to the right (Figure 2007, view B) the test mass lags behind since the acceleration is applied to the frame, not the test mass. The test mass displaces enough for the constraining springs to apply a force proportional to the acceleration. The test mass then moves with the case maintaining its constant displacement. When the acceleration is removed from the frame, the constraining springs cause the test mass to move (with respect to the case) back to the neutral position. Thus, a body at rest or a body at constant velocity (zero acceleration) causes no displacement, providing the accelerometer is held horizontal. If the accelerometer is tilted or placed on end, the force of gravity causes the mass

to move in the same way as does an actual acceleration, even though the frame is at rest.

This basic accelerometer demonstrates the principle of operation of inertial accelerometers. It must be kept in mind that these inertial accelerometers are sensitive to more than just the accelerations with respect to the earth. Since they are sensitive to accelerations in space, their output includes other inertial accelerations which are not due to travel over the earth's surface. A compensation must be made for these inertial accelerations so that the quantity left is the acceleration with respect to the earth. What these inertial accelerations are and how compensations are made is discussed in Section 2014.

INERTIAL NAVIGATION SYSTEM MECHANIZATIONS

2008. Inertial Navigation System Mechanizations

An INS may be mechanized as either a gimballed system

or a strapdown system. In both mechanizations, the accelerometers function to sense the linear accelerations of the craft, from which linear velocity is computed, and the gyros

function to sense the angular motions of the craft. However, in a gimbale system, the gyros respond to the sensed motions by rotating the platform (with the help of gimbal torquer motors, as necessary) so that a constant frame of reference is maintained and the outputs of the gyros remain at zero. Thus, the craft's velocity, attitude, and position can be directly computed with respect to the constant reference frame. In a strapdown system, the gyros are fixed to the craft and sense its full rotational rate as it maneuvers. The output of the gyros is used by the navigation computer to relate the motions sensed by the accelerometers to the desired reference frame.

Both inertial navigator mechanizations are described below. Although most systems nowadays are strapdown, the discussions throughout this chapter assume a stable platform (gimbale) implementation, as it is easier to visualize inertial navigation principles using a gimbale model. These discussions are mathematically equivalent to a strapdown model. In addition, no matter the mechanization, all inertial navigators operate on the same principles and are subject to the same fundamental types of errors (Sections 2015 - 2021).

2009. Gimbaled INS

In a gimbale INS, the gimbals, gyroscopes, and accelerometers together with associated electronics and gimbal torque motors form a stable platform. The function of this stable platform is to establish and maintain a reference system in which the measurements necessary to produce the navigator outputs are taken. The stable platform may be aligned to any chosen reference system, but two that have been historically used are the inertial reference system and the local vertical reference system.

A platform aligned to an inertial reference system (i.e., the fixed stars) is called a space-stable INS. In a space-stable INS, the platform is stabilized to maintain accelerometer alignment in a constant direction relative to distant space, regardless of the platform's orientation with respect to the earth. The inertial reference system complements the natural behavior of spinning mass gyros, although any type of gyro may be utilized in any reference system.

A platform in local vertical alignment is oriented such that one accelerometer is aligned with the vertical gravity vector. The other two accelerometers are generally aligned in the north and east directions. Torqueing motors on the gimbals are used to maintain this alignment. A variation of the local-vertical system is the wander-azimuth mechanization, in which the horizontal accelerometers are not slaved to the north and east directions, but are allowed to "wander" around the vertical axis. This mechanization is especially useful near the poles, where even small vessel motions would require frequent torqueing of the INS due to the meridian convergence. An advantage to either form of local vertical alignment is that the horizontal accelerometers are isolated from measuring gravity.

Since the craft in which the stable platform is mounted operates in three dimensional space, it has three degrees of freedom with respect to the earth. In order to maintain a reference fixed to the earth, the stable platform must have three degrees of freedom with respect to the craft. The stable platform contains at least three gimbals, one for each degree of freedom necessary for the stable platform. (Extra gimbals may be used to improve mechanical performance). Each gimbal has rotational freedom about one axis with respect to its supporting element. Depending on the platform mechanization, the gimbal may have a torqueing motor that allows it to be driven with respect to its support about the gimbal axis.

2010. Strapdown INS

In a strapdown INS, the accelerometers and gyroscopes are connected directly to the frame of the vehicle—that is, they are not isolated from the ship's movement by a series of gimbals. Instead, the sensors measure accelerations directly in the craft's reference frame, and the navigation computer analytically "rotates" these measurements into the desired navigation reference frame based on the output of the gyros. From this point, the accelerometer measurements can be integrated into velocity and position in the desired frame. In general, a strapdown INS trades the mechanical complexity of a gimbale system for the computational complexity required to track all the craft's motions analytically.

Unlike gimbale gyros, which only sense small rotations as they continuously re-orient the stable platform, strapdown gyros are exposed to the full rotational rate of the craft. Thus, gyros used in strapdown systems must be able to maintain accuracy over-essentially, "keep up with"—those rotational rates. While typical rotational rates of a maritime craft are unlikely to strain a gyro's performance, crafts such as military aircraft require robust sensors to handle their high rotational rates. Strapdown inertial navigators that use optical gyros are especially useful for such vehicles, as well as for applications where size, weight, and cost constraints are important considerations

2011. Hybrid (Quasi-Strapdown) INS

In a quasi-strapdown INS, the accelerometers and gyroscopes are mounted on a stable platform supported by one or more sets of gimbals, similar to a true gimbale INS (Section 2009). The difference is that the stable platform is not rotated to maintain local level continuously; rather, the stable platform is rotated through various angles, typically 90 degrees or 180 degrees, to a new position every few minutes to reverse and manage long-term error growth. Quasi-strapdown INSs that use optical gyros share common traits with both the gimbale and strapdown INS. Typically, they are chosen for increased long-term navigation accuracy (longer time needed between external fixes) but at a lower cost, size and weight of a fully gimbale INS. The current US

Navy AN/WSN-7 is an example of this type of INS.

MOTIONS AFFECTING INERTIAL NAVIGATION SENSORS

2012. Motions Affecting Inertial Navigation Sensors

The INS sensors will detect any motion relative to inertial space, including motions that do not describe position, velocity, or orientation with respect to the earth. This means that any motion or force which might disturb the reference system must be accounted for and its effect must be eliminated. This would include motions in inertial space as well as motions of the craft in which the navigator is mounted.

The motions affecting the inertial sensors may be divided into two categories: rotations and accelerations. The rotations are:

1. Craft's roll, pitch, and yaw
2. Earth's rotation (earth rate),
3. Changes in latitude and longitude.
4. Platform indexing, where applicable

The accelerations of concern are:

1. Craft's acceleration with respect to the earth in three linear directions,
2. Gravity,
3. Coriolis acceleration.

These motion-based impacts on the INS are a function of the physics of motion on a rotating and spinning ellipsoid, are predicable, and are generally accounted for within the processing of the equations of motion. Other factors that can influence the sensors outputs, including environmental, electrical, and magnetic influences, must be managed within the design and implementation, and are not always predictable. Controlling these factors is discussed in Sections 2023 - 2025.

There are also some inertial motions whose effects are negligible; that is, their effects are below the sensitivity level of the sensors. These motions are precession and nutation (Sections 1317, 1319) and the acceleration of the earth in its orbit in accordance with Kepler's second law (Section 1306).

Since the inertial navigator deals with the earth-referenced values of velocity, attitude, and position, and since the gyroscopes sense direction with respect to inertial space, it is necessary that the gyroscopes be controlled to maintain a reference with respect to the earth. In the discussion of the inertial navigator which follows, unless otherwise noted, the earth reference used is the local vertical and an orientation with respect to true north. **However, the same principles apply, either physically or computationally, to all INS mechanizations.**

2013. Rotations

1. Roll, pitch, and yaw describe the orientation of a vessel in its local reference frame, thus, are desired measurements of the INS and do not require additional compensations.

For a gimbale platform, if the supporting craft should undergo any base motion (roll, pitch, or yaw) about a gimbal axis, the platform would ideally remain fixed in inertial space. However, some friction in the gimbal axis will always exist, so some small portion of the motion of the supporting craft will be transmitted to the platform. The gyroscope would sense this motion instantaneously, and its output would excite the gimbal torquer motor which in turn would drive the gimbal with respect to the craft about the gimbal axis, counteracting the motion that had been transmitted to the platform. If the rate of platform disturbance increases or decreases, the gyroscope output signal increases or decreases to keep the gimbals-and thus, the accelerometers-in the same position relative to the earth

For a strapdown system, gimbals and torquer motors are not used. The INS computer interprets the output of the gyroscopes and uses this information to mathematically orient the platform's accelerometers.

2. The rotation of the earth causes the local vertical, north and east directions for a given position to change their directions in inertial space. These changes are not obvious to anyone on the earth because they maintain the same orientation with respect to the earth. Thus, the gyroscopes will sense motion due to the earth's rotation even when the vehicle is stationary on the earth. To compensate, an earth rate torquing signal is applied so that the inertial navigator rotates about the earth's spin axis at the same rate that the earth does. As a result, the inertial navigator maintains the desired orientation with respect to the earth as the earth rotates in inertial space, and the apparent motion of the vessel is canceled. For strapdown systems, the earth rate correction is made mathematically within the INS computer rather than with gimbals

3. Changes in latitude and longitude are desired outputs of the INS, and are measured in the same way that roll, pitch, and yaw motion are measured. However, an additional compensation is needed due to the fact that the vessel is navigating on or near a spherical earth, rather than a flat plane: The change in position of the inertial navigator on the earth's surface causes the local vertical to change direction in space. This is due to the fact that in going from one position to another the inertial navigator is changing from one local vertical to another. This is demonstrated in Figure 2013a. As the inertial navigator travels over the earth's curved surface from position 1 to position 2, the "correct"

orientation is shown by the solid line figure at position 2. The broken line figure represents the inertial navigator after

the change in position without compensation for the change in the local vertical.

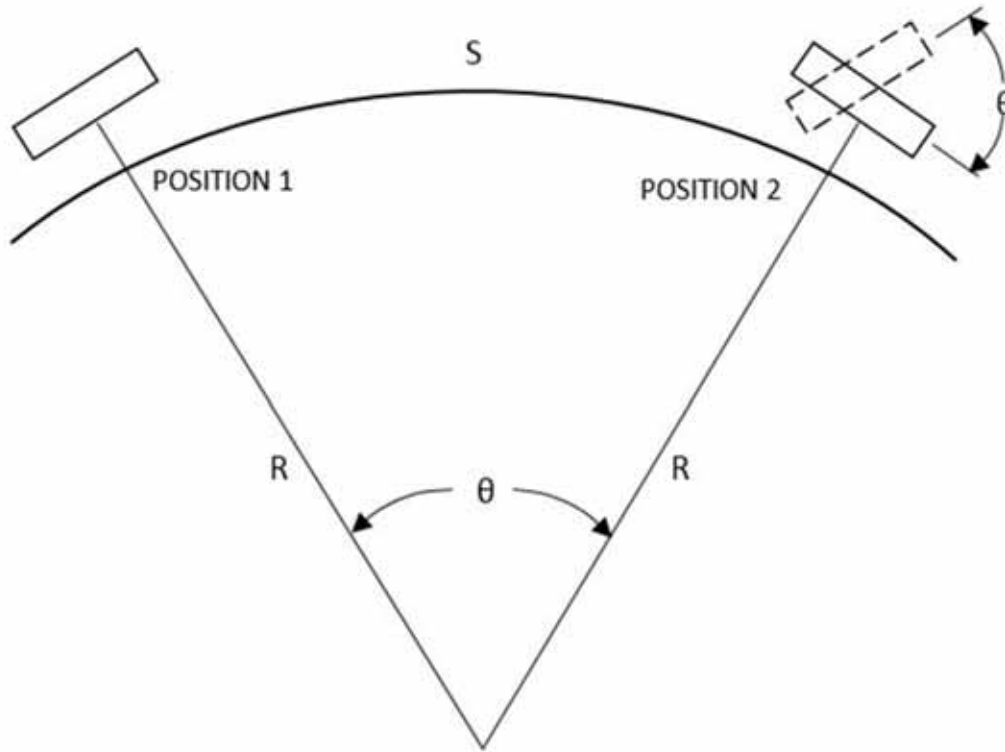

Figure 2013a. Change in local vertical with movement over earth's surface. Courtesy of Michelle C. Greiner, Johns Hopkins University - Applied Physics Laboratory.

As shown in Figure 2013a, the total angular change in the local vertical in moving from position 1 to position 2 is represented by θ . The value of θ , expressed in radians, is a function of the distance traveled, S , and the radius of the earth, R . Stated mathematically, this is:

$$\theta = \pm \frac{S}{R}$$

(The \pm sign is determined by the direction of travel in the right-handed north-east-down coordinate system: Movement in the positive east direction causes a positive rotation around the north axis, while movement in the positive north direction causes a negative rotation around the east axis. See Figure 2013b.

The quantity of interest in maintaining the correct orientation to the local vertical due to change in position is the rate of change of θ with respect to time. Assuming R to be constant, the angular rate ω is given by:

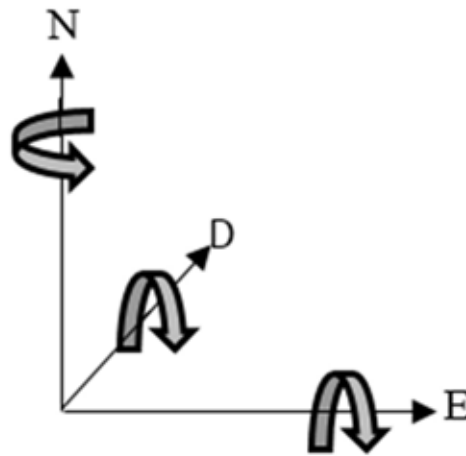

Figure 2013b. Right-handed north-east-down coordinate system. Courtesy of Michelle C. Greiner, Johns Hopkins University - Applied Physics Laboratory.

$$\omega = \frac{d\theta}{dt} = \pm \frac{1}{R} \frac{dS}{dt}$$

Since the time rate of change of distance, S , is velocity, V ,

$$\omega = \pm \frac{V}{R}$$

Thus, the appropriate gyroscopes must be torqued at this rate, or the compensation applied through the computer for strapdown systems, so that the vertical indication of the inertial navigator will remain correct as the craft moves over the curved surface of the earth. When the gyroscopes receive a properly calibrated signal to compensate for the change in the local vertical due to movement over the earth, the system is said to be *Schuler tuned*.

Schuler compensations are required in both horizontal directions in order to maintain the correct orientation of the vertical. In the local vertical INS example, the north Schuler compensation includes the north gyroscope and the east accelerometer. The east Schuler compensation includes the east gyroscope and the north accelerometer.

The Schuler compensation corrects the INS platform tilt caused by its motion over the surface of the earth, thus keeping the platform correctly aligned to the local vertical. However, if a platform tilt arises that is not due to motion over the earth, or if the calculated angular rate and the actual angular rate are not identical, the result is a **Schuler oscillation** (Section 2018).

4. Some INS are mechanized to use one or more gimbals to change the physical orientation of the platform sensors at specific intervals. This is done to reduce long-term error growth due to misalignment of the sensors. When the platform is flipped (or “indexed”), sensor misalignments become oriented in a different direction, causing the direction of error growth to change. The gyros, naturally, sense these movements as actual ship rotations. However, the periodicity of these movements is part of the system design, and the INS computer mathematically cancels these sensed rotations from its outputs of position, velocity, and attitude, for these sensed rotations.

2014. Accelerations

1. The craft's accelerations with respect to the earth are desired outputs of the INS and are measured by the accelerometers. For stable platforms, the accelerometers measure changes in velocity in the three constant, desired directions. For strapdown systems, the INS computer interprets the output of the gyros to assign directions to the sensed accelerations. By integration of these measurements over an accurate measure of time (Chapter 16), velocity and position are obtained.

Accelerometers may also sense roll, pitch, and yaw motion if the INS is not centered on the axis of rotation of the vessel. For example, one can imagine an INS located at

either the port or starboard hull of a ship, rather than at the centerline. As the ship rolls around the centerline, the INS will be physically displaced in both the vertical direction and at least one horizontal direction. The accelerometers will sense this motion and integrate into a velocity and ultimately a change in position. However, the oscillatory nature of base motions means that this position change will be canceled when the vessel then rolls in the opposite direction. Thus, detection of base motions will not lead the INS to falsely compute long-term changes in position.

2. If the accelerometer is tilted, its output will be affected by **gravity**. The output which would be produced would not be due to any acceleration of the inertial navigator with respect to the earth; thus, a compensation must be made. The simplest solution for elimination of the effect of gravity is to place the accelerometer so that its sensitive axis is perpendicular to gravity. Since all accelerations which result in a change in position are perpendicular to the local vertical, this orientation allows the accelerometer to measure these accelerations without being affected by gravity. Two accelerometers, then, are placed perpendicular to the local vertical and perpendicular to each other so that together they can measure any acceleration which will result in a change of position on the earth's surface. A third accelerometer is necessary to measure any accelerations of the navigator along the local vertical. (This is the orientation of accelerometers used in the local vertical mechanization of the INS). The accelerometer that measures motion in the vertical direction also senses the total magnitude of gravity acceleration. The INS computer compensates by removing the known acceleration of gravity from the vertical channel before computing velocity. For an INS that is not oriented in the local vertical reference frame, the INS computer subtracts gravity from all accelerometers as necessary.

The geometric figure that describes the earth's gravitational equipotential is called the geoid. This is the irregular surface to which the oceans would conform over the entire earth if free to move through landmasses and adjust to the combined effect of the earth's mass attraction and the centrifugal force of the earth's rotation. The geoid has a special property that, at every point on the geoid, the direction of gravity is given by a plumb line at that point. However, inertial navigation systems are mechanized in terms of a reference ellipsoid, which approximates the geoid but is not an exact match. Relative to the ellipsoid, the direction of gravity is not always a plumb line. The angle between the normal to the geoid and the normal to the reference ellipsoid is called the **vertical deflection** (or deflection of the vertical). If the vertical deflection is not accurately modeled within the INS computer, errors will be induced in the INS output due to the accelerometers interpreting components of gravity as accelerations over the earth. Thus, it is important that the gravity be well mapped to ensure accurate INS output.

The reference ellipsoid currently used by GPS systems

and by United States navigation charts is the **World Geodetic System of 1984** (WGS 84). Further information on WGS 84 and vertical deflection can be found in Chapter 2 - Geodesy.

3. The **Coriolis acceleration** is not a true acceleration, but an apparent effect observed in a rotating reference frame as Newton's laws of motions play out in inertial space. When a vessel moves over a rotating surface perpendicular to the axis of rotation, it must provide a force to overcome inertia and continue moving at a constant velocity relative its local, rotating frame. The inertial accelerometers sense this force and interpret it as a change in speed. This INS computer must cancel this effect to obtain an accurate measure of the speed relative to the rotating frame. A merry-go-round can be used to illustrate the Coriolis acceleration phenomenon.

If as shown in Figure 2014 a ticket-taker starts from the center of a merry-go-round with a velocity, v , toward horse A , he will reach the horse at some finite time t later. With respect to the merry-go-round he traveled at a constant velocity and therefore did not accelerate. However, when using the ground below the merry-go-round as the reference in which to make the measurements of his motion, it can be seen that in the time it takes for the man to get to the horse, the horse has moved to position A' . This is due to the rotation, ω , of the merry-go-round. The path of the man with respect to the ground is shown as the solid curve even though his velocity with respect to the merry-go-round is directed radially at all times as shown by the two representative vectors along the path.

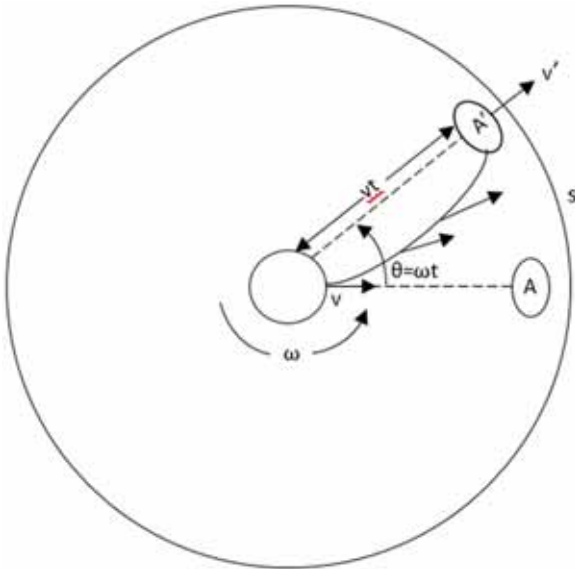

Figure 2014. Motion on a merry-go-round. Courtesy of Michelle C. Greiner, Johns Hopkins University - Applied Physics Laboratory.

Although the ticket-taker is walking at a constant velocity, he finds that as the ride rotates counter-clockwise, he must exert extra force to his left in order to continue on his

straight-line path. Otherwise, his walking tends to drift to the right due to inertia. This is an example of the Coriolis effect: a sensor on the ticket-taker's body would sense the exerted force to the left even though in his own reference frame he did not change either speed or direction.

While traveling from the center to the horse, the man was moved (with respect to the ground) counterclockwise, a distance S . This distance, written in terms of the acceleration which produced it, is:

$$S = 1/2 at^2$$

The distance may also be expressed in terms of the angle θ (which equals the angular rate, ω , of the merry-go-round multiplied by the time, t) and the radius (which equals the velocity, v , of the man with respect to the merry-go-round multiplied by the time, t , involved). This expression is:

$$S = \theta vt = \omega vt^2 = \omega vt^2$$

By equating these two expressions and solving for a ,

$$1/2 at^2 = \omega vt^2$$

The principle of conservation of angular momentum states that a mass in motion will maintain its angular momentum if no external forces are applied. The formula for angular momentum is given by:

$$\text{angular momentum} = r \times mv$$

On the earth, as a body in motion travels northerly in the Northern Hemisphere, the radius r of rotation decreases with latitude. In order for the angular momentum of the body to be maintained in inertial space, its linear velocity v must increase in the direction of rotation (eastward for a counterclockwise-rotating earth) as r decreases. As the body moves northward and its easterly velocity increases, it gets deflected to the right relative to the earth's coordinate system. In inertial space, however, no acceleration occurred; thus, the accelerometers did not sense the deflection. Conversely, the body must exert a force to the left (westward) in order to continue on a straight northward path at a constant velocity relative to the earth. In this case, the accelerometers sense the westward force even though no acceleration took place in the earth reference frame.

If a body were to move southward in the Northern Hemisphere, the radius of rotation would increase, necessitating a decrease in velocity in the direction of rotation in order to change angular momentum. The body would again be deflected to the right-westward this time-as its linear velocity slowed relative to the earth reference frame. In the Southern Hemisphere, bodies traveling in either direction would be deflected to the left and have to compensate with an acceleration to the right.

The change in the earth's radius of rotation is propor-

tional to the convergence of the meridians, or the sine of the latitude. Thus, for a body traveling over the earth, the acceleration is given by:

$$a = 2\omega v \sin(L)$$

where ω is the earth's rotational rate, v is the north-south velocity of the moving craft, and L is the latitude. This apparent effect was first discovered by Gaspard Gustave de Coriolis, for whom it was named, shortly before the middle of the nineteenth century.

INERTIAL NAVIGATION SYSTEM ERRORS

2015. Inertial Navigation System Errors

Every INS, regardless of its mechanization, provides an output that is corrupted by various errors. In many cases, the observed errors in INS output of position, velocity, and attitude are caused by errors in the accelerometer and gyro output or alignment. Other sources of errors in INS output include errors associated with the physics of sensing motion on a rotating planet, unmodeled geodetic or geophysical parameters like gravity, processing errors, manufacturing variances in the hardware and sensors, aging effects of components, timing latency errors (differences in time that INS and other sensors measure the same motion), and environmental effects. For mariners, the parameters being measured (vessel accelerations) are so small that even manufacturing variances or environmental changes are of possible impact. In particular, optical gyros are so sensitive that changes in temperature and pressure need to be accounted for and managed.

In general, INS are designed for specific applications and requirements (including performance, cost, size, weight and power) and all engineering designs require some tradeoffs to meet the specifications. The INS needed by an aircraft under high-G flight conditions and relatively short duration flights (hours) is different from a submarine transiting at relatively slower speeds, with few fix opportunities, and supporting long duration missions (weeks to months).

For the mariner, there are four errors in the horizontal channels that are observable by the navigator in real time and can be managed with proper operation, grooming and maintenance: The 84.4-minute Schuler oscillation, the 24-hour earth loop oscillation, position offsets, and longitude ramps. Modern INSs are “tuned systems” designed to reduce known errors at specified natural frequencies; thus, any noise introduced will often result in a tuned error response, such as the Schuler error.

The following sections describe the major INS sensor errors as well as the four observable errors in INS output. Also presented is an additional coordinate system, which is useful for visualization of the causes of some of the observable errors. Techniques to control these errors are discussed in Sections 2023 - 2025.

2016. Sensor Errors

INS sensor errors are the predominant cause of the four

observable errors in INS output. Typical errors present in most INS sensors are described below.

Sensor biases: Accelerometer and gyroscope biases are the average outputs when the sensors are stationary and sitting still. Since accelerometer outputs are integrated to velocity and a gyroscope is integrated to find platform orientation angle, uncorrected constant sensor bias errors will grow linearly with time and are often the dominant error source in an INS. These errors can be estimated and removed with an effective calibration.

Sensor bias repeatability (turn-on): Frequently when an INS is powered up, the bias observed in each sensor's outputs will be different from turn on to turn on. This can be due to changing physical properties in the INS, environmental conditions and internal signal processing in the INS. A very repeatable sensor output leads to quicker and better calibration of the sensor, whereas sensors with more variable biases required a much longer and often more complex calibration process.

Sensor bias stability (in-run bias): While an INS is powered up, the bias observed in each sensor's outputs can change over time. The change can be due to environmental conditions like temperature, pressure or mechanical stress on the sensors. For example, in the case of optical sensors, environmental conditions can change the optical path and thereby contribute to sensor bias stability. For this reason, calibration and internal sensor monitoring generally include corrections for environmental conditions, such as temperature.

Scale factor: Whereas biases are constant offsets in a sensor's output, scale factor errors represent a linear error that is a function of the sensor input. The error in the sensor's output is proportional to the magnitude of the sensor's inputs. The effects of scale factor errors are thus most prevalent in application involving high acceleration and angular motion.

Random Walk: When a sensor measures a constant signal, a random error is always present in each sensor output. Integration of the random errors in the measurements lead to a random walk error, which are zero mean, but cause the sensors to walk off randomly. Random walk is the largest error sources in many inertial sensors and can cause INS errors to grow unbounded.

Misalignments (non-orthogonality): In an INS, the three gyroscopes and three accelerometers are mounted orthogonal (at 90-degree angles) to one another. The sensor mountings have errors, however, so the axes are not per-

fectly at 90 degrees; thus, the axes are misaligned. This leads to an undesirable correlation between sensor outputs. For example, assume one axis is pointed perfectly vertical and the INS is level. The accelerometer on this axis is measuring gravity. If the other two axes were perfectly orthogonal, they do not measure any of the effect of gravity. If there is a misalignment so that the non-vertical accelerometers also measure components of gravity, then this leads to an error in the INS output due to axis misalignment.

G and G-squared Dependencies: Some accelerometers and gyroscopes are sensitive to changes in sensed acceleration. When the sensor experiences a change in acceleration (G-dependency) along the sensitive axis, then the sensor bias changes, resulting in an output error in the system. G-squared dependencies are a result of non-linear effects of changes in acceleration on the sensor outputs. Sensors undergoing high rates of acceleration can be cali-

brated for these types of errors.

2017. Coordinate Systems

Two orthogonal coordinate systems are used to relate the inherent errors to the inertial navigator. One system is the north-east-down system mentioned in Section 2013, consisting of orthogonal N, E, and D axes. The relationship of this coordinate system to the second system, the equatorial coordinate system, is shown in Figure 2017. The equatorial system consists of P (polar), Q (equatorial), and E (east) axes. The P axis is parallel to the earth's axis of rotation. The Q axis is parallel to the equatorial plane and is directed outward from the earth's axis of rotation. The E axis is coincident with the E axis of the other coordinate system.

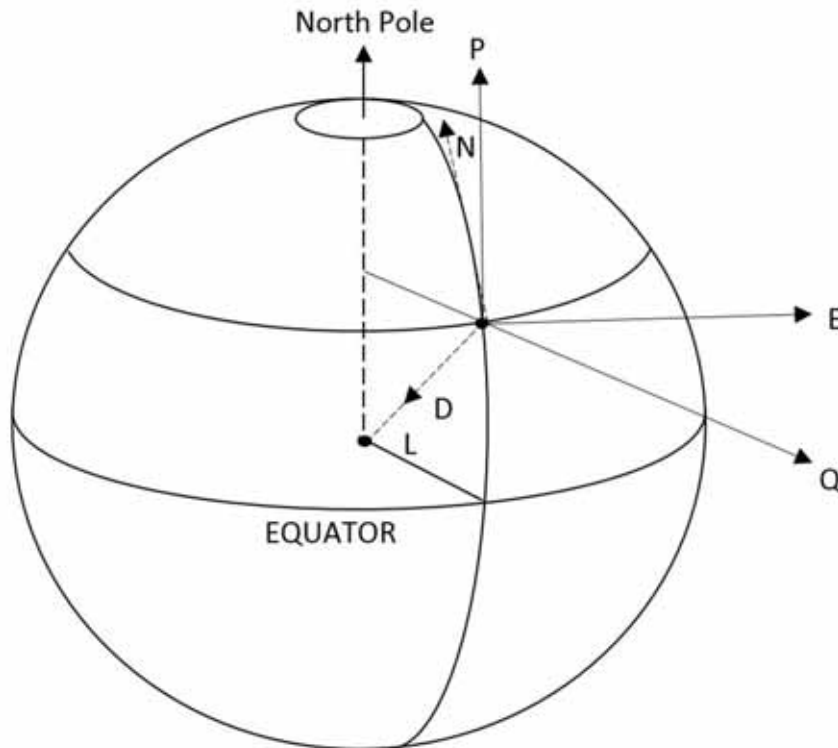

Figure 2017. Orthogonal coordinate systems. Courtesy of Michelle C. Greiner, Johns Hopkins University - Applied Physics Laboratory.

The first coordinate system is physically represented in the gyroscope arrangement on the stable platform of the inertial navigator. The computer of the inertial navigator maintains a mathematical representation of the equatorial coordinate system. The relationship of the two systems is expressed mathematically as:

$$N = P \cos L - Q \sin L$$

$$E = E$$

$$D = -P \sin L - Q \cos L$$

In some of the following examples, the equatorial coordinate system is used to explain the origin of INS errors. In these cases, the equatorial coordinate system allows for an easier visualization of the error source than any other co-

ordinate system. However, the reader should remember that the principles of INS, including the observable errors, are independent of the mechanization or chosen reference frame for the platform alignment.

2018. Schuler Oscillation

Schuler tuning, described in Section 2013, is a computation made in the INS to ensure that the vertical indication of the inertial navigator remains correct as the craft moves over the curved surface of the earth. Figure 2018a shows a block diagram of the Schuler “loop,” which is the combination of the Schuler tuning described in Section 2013 (shown in solid lines) and the inherent feedback of any residual platform tilt errors into the horizontal accelerometers (shown in dashed lines).

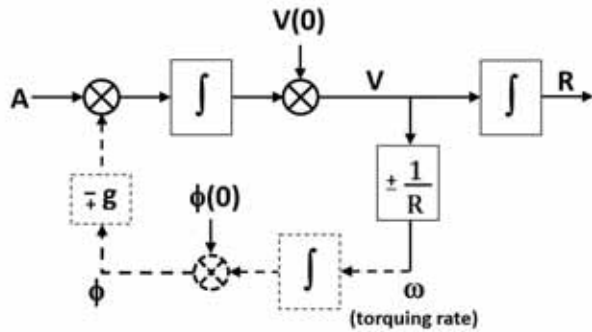

Figure 2018a. Block diagram of the Schuler loop. Courtesy of Michelle C. Greiner, Johns Hopkins University - Applied Physics Laboratory.

For a local-vertical stabilized INS, when no platform tilt errors exist, no gravity acceleration is sensed by the horizontal accelerometers. The only quantity measured is the horizontal acceleration A , which is integrated to produce velocity V . This velocity is divided by the radius of the earth (positive for east-west motion, negative for north-south motion, as described in Section 2013) to produce the angular rate ω . This angular rate offsets the actual angular rate at which the platform is tilting in the opposite direction. Therefore, when ω is integrated again, the resultant angle fully offsets the platform tilt, yielding a residual platform tilt, ϕ , of 0. Thus, no acceleration error due to gravity is sensed, and the platform maintains its correct vertical indication.

However, if a platform tilt should arise in error, the horizontal accelerometer will sense a gravity component and interpret this as a true acceleration. When integrated over time, a velocity error, δV , will result, leading to a calculated angular rate ω that does not match the actual angular rate of motion over the earth. The residual platform tilt, ϕ , will be non-zero, and a component of gravity will continue to be felt by the horizontal accelerometer.

Mathematically, the horizontal acceleration error is given by:

$$\delta A = \mp g \sin(\phi) \approx \mp g \phi$$

The small angle approximation is used to simplify the error term. The positive or negative sign is determined by the assumed direction of motion over the earth: A translation of gravity from the down direction to the north direction causes a positive rotation around east, while a translation from the down direction to the east direction causes a negative rotation around north.

Integration of an acceleration error results in a velocity error:

$$\delta V = \int \delta A dt = \mp g \int \phi dt$$

The error in velocity leads to an error in the angular rate calculation:

$$\delta \omega = \pm \frac{\delta V}{R} = -\frac{g}{R} \int \phi dt$$

By definition, the angular rate is equal to the first derivative of the angle ϕ ; thus,

$$\delta \omega = \frac{d\phi}{dt} = -\frac{g}{R} \int \phi dt$$

Differentiating:

$$\frac{d^2 \phi}{dt^2} = -\frac{g}{R} \phi$$

The solution to this equation is an oscillation:

$$\phi = \phi_0 \cos\left(\sqrt{\frac{g}{R}} t\right)$$

where the initial platform tilt ϕ_0 determines the amplitude of the oscillation and the oscillation frequency is given by $\sqrt{g/R} \approx 84.4$ minutes. This equation is the same as that of a simple pendulum with a length equal to the radius of the earth. The initial tilt error gets integrated into both velocity and position, causing the characteristic Schuler error in those outputs.

To visualize what is being sensed by the INS, one can consider an INS platform that is stationary, but has an initial tilt error ϕ , as shown in Figure 2018b. The initial tilt causes the platform computer to think it is located to the right of its actual position, and a portion of the downward gravity vector will be sensed in the right side of the platform, causing the computer to think the platform is accelerating to the left. The computer's interpretation is shown at position A in Figure 2018c.

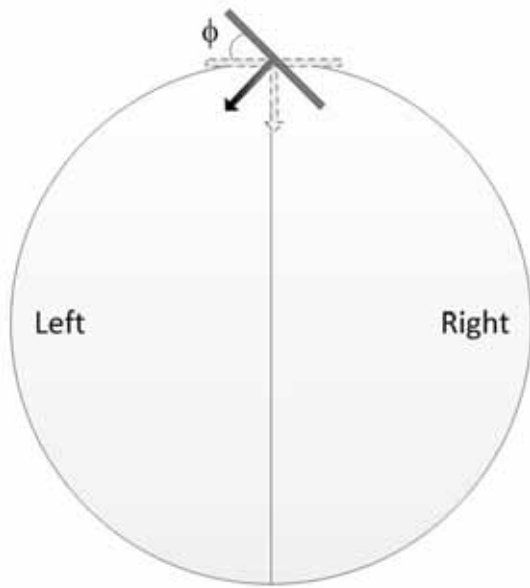

Figure 2018b. Stationary platform with initial tilt error ϕ . Courtesy of Michelle C. Greiner, Johns Hopkins University - Applied Physics Laboratory.

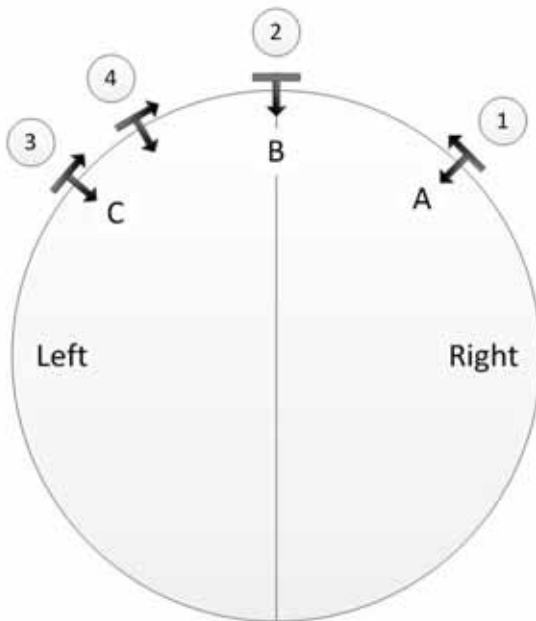

Figure 2018c. Platform computer's interpretation of position and velocity. Courtesy of Michelle C. Greiner, Johns Hopkins University - Applied Physics Laboratory.

As the computer thinks the platform is moving to the left toward position B (its true position), the Schuler tuning will incrementally reduce the tilt error until the platform is level at position B . At this point, the horizontal accelerometer no longer senses gravity, so the acceleration and tilt

errors are both zero. However, the erroneous accelerations computed until now lead the platform to believe velocity is now at a maximum and that the platform is still moving to the left. The Schuler tuning will continue to mathematically or physically torque the platform counterclockwise to compensate for this assumed motion over the earth, until the computed velocity is reduced to zero at position C in Figure 2018c. At this point the computed acceleration is equal and opposite to the computed acceleration at A , and the process begins again, but in the opposite direction.

Figure 2018d, Figure 2018e, and Figure 2018f show the graphical representation of the tilt, acceleration, velocity, and position errors at the various points displayed in Figure 2018c. In Figure 2018d, the size of Area A represents the total velocity that is computed from the time the platform is assumed to be at position A until the platform is level again at assumed position B . At this point the velocity error is at a maximum (Figure 2018e), and position error is zero (Figure 2018f). The sum of Areas A and B yield the total velocity computed by the time the platform has reached assumed position C . Because one of these areas is positive and one is negative, they cancel, yielding zero velocity. Figure 2018e and Figure 2018f show a zero velocity error and a maximum position error, respectively. Area C shows an incremental velocity that is computed between points 3 and 4 in Figure 2018c.

Remember that in this example, the platform is not actually changing its position during this process. It is stationary at position B , with tilting back and forth as the only physical movement. These errors will repeat in a regular oscillation until the system is affected by an outside force that either intensifies the magnitude of tilt, velocity, and position errors, or reduces it. Provisions must be made for damping (Section 2024) this oscillation.

2019. Earth Loop Oscillation

The 24-hour earth loop oscillation is caused by initial errors in platform alignment or gyro bias. An initial error in either latitude or heading causes both quantities to oscillate about their true values within a 24-hour period. A gyro bias error limits the ability of the inertial navigator to determine latitude and heading, thus causing latitude or heading to oscillate about an offset value. The following discussion illustrates the 24-hour oscillation for an initial heading error.

In Figure 2019a, the inertial navigator is stationary on the equator at point T_0 , with a platform misalignment such that there is a displacement of the equatorial coordinate system (Section 2017) sensed by the navigator (designated by P' , Q' , and E' in the figures) from the true equatorial coordinate system (designated by P , Q , and E in the figures). Thus, as the earth rotates around the P axis, the navigator senses that it is rotating around the P' axis. In inertial space, the navigator senses that it is following the dashed path in Figure 2019a rather than the solid equatorial path.

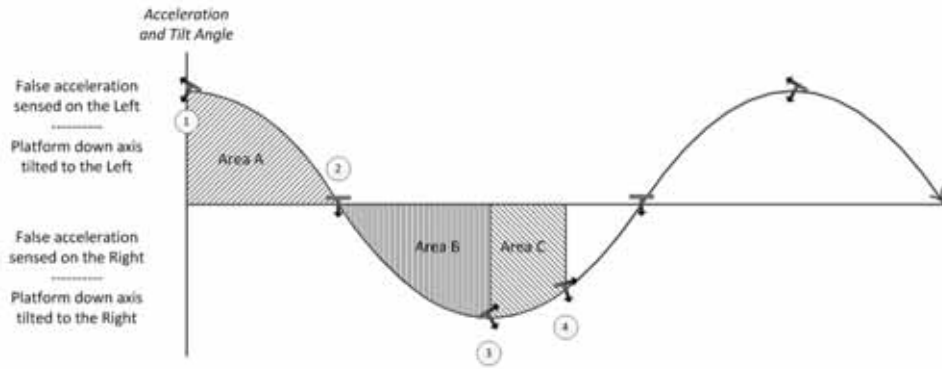

Figure 2018d. Graphical representation of Schuler acceleration and tilt error. Courtesy of Michelle C. Greiner, Johns Hopkins University - Applied Physics Laboratory.

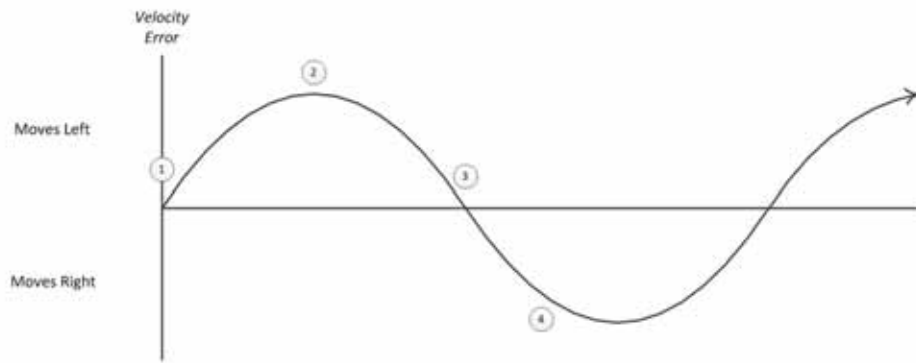

Figure 2018e. Graphical representation of Schuler velocity error. Courtesy of Michelle C. Greiner, Johns Hopkins University - Applied Physics Laboratory.

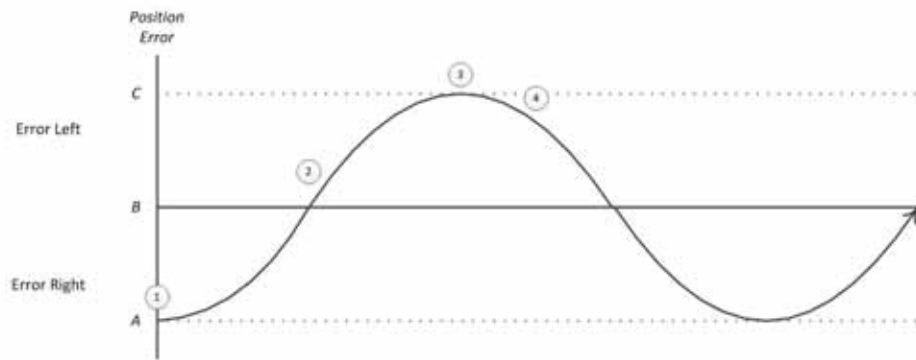

Figure 2018f. Graphical representation of Schuler position error. Courtesy of Michelle C. Greiner, Johns Hopkins University - Applied Physics Laboratory.

The platform misalignment is initially a heading error—that is, a displacement about the Q axis—and is represented by the angle δ_Q between E and E' . As shown, this is a positive heading error because the heading readout of the navigator will be larger than the actual heading by the amount δ_Q . No latitude or longitude error results because

there is no displacement about either the E or the P axis (i.e., the Q axis and Q' axes are coincident).

After this initial setup, the earth rotates about the P axis and the navigator mathematically rotates about the P' axis. Recall that while the P and P' axes maintain their positions in inertial space, the E and Q axes (and the E' and Q' axes) are always oriented relative to the navigator. After 6 hours

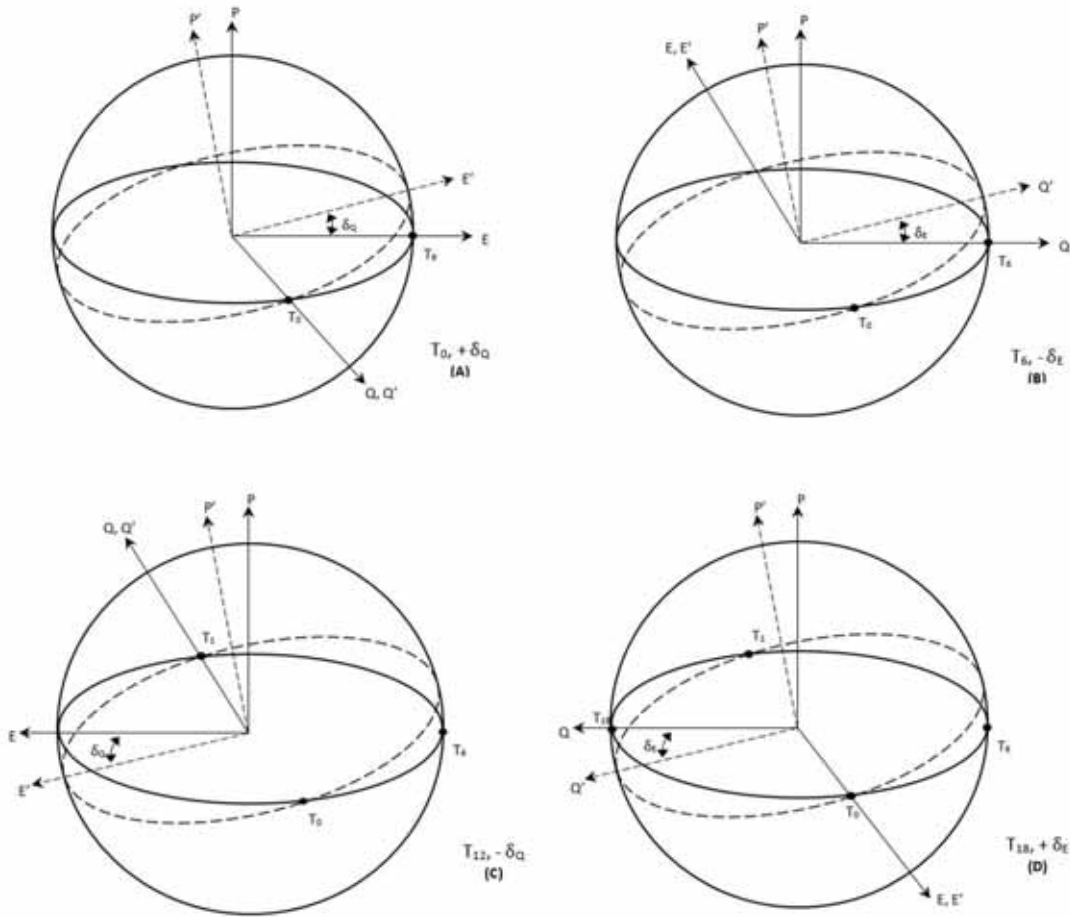

Figure 2019a. The 24-hour oscillation for an initial heading error. Courtesy of Michelle C. Greiner, Johns Hopkins University - Applied Physics Laboratory.

the navigator is at point T_6 due to earth's rotation, and the relationship between the coordinate systems has changed (Figure 2019a (B)). The misalignment between the two systems is now about the E axis and is shown as the angle δ_E . This represents a negative latitude error in the navigator since its coordinates are displaced in a negative rotation about the E axis, and the heading error is now zero, because there is no displacement about the Q axis (i.e., E and E' axes are coincident with each other). Hence after 6 hours the heading error has been reduced to zero, but a negative latitude error has been produced.

The earth continues to rotate, and after 6 more hours, the navigator is at the position T_{12} , shown in Figure 2019a (C). Once again the misalignment of the navigator's reference system with respect to the earth is about Q axis, meaning an error in heading and no error in latitude. This time the heading error is negative but of the same magnitude as at T_0 .

During the next 6 hours this negative heading error diminishes until it has decreased to zero as shown in Figure 2019a (D). At the same time, the latitude error is building

up in a positive direction to the value shown. At T_{18} the misalignment of the navigator is about the E axis again, which results in a positive latitude error and no heading error. This positive latitude error has a magnitude equal to the negative latitude error at T_6 .

If the errors shown in Figure 2019a are plotted against time, the latitude error will be a negative sine wave with a 24-hour period since the oscillation started with a positive heading error. The heading error will be a cosine wave with a 24-hour period. The latitude error curve leads the heading error curve by a 90° phase relationship. At the equator, due to the geometry of the reference systems, the maximum value of δ_Q equals the maximum value of δ_E . At the equator the maximum latitude and heading errors due to the 24-hour oscillation are equal.

The relationship among navigator errors is a function of latitude. Figure 2019b represents an initial heading error as a vector along the local vertical. This vector represents a displacement of the navigator's reference system about this axis and is a positive heading error in this example. The components of this misalignment along the P axis and the

Q axis are also shown. The component along the P axis is equal to $\delta_H \sin L$ and contributes to the longitude error of the navigator since it is a misalignment about the earth's spin axis or polar axis. This relationship shows that at the equator, the heading error would cause no longitude error and there would be no 24-hour oscillation in longitude. The

other component along the Q axis is called δ_Q and has a value of $\delta_H \cos L$. This component determines the 24-hour oscillation due to an initial heading error in an inertial navigator with no uncompensated gyro drifts.

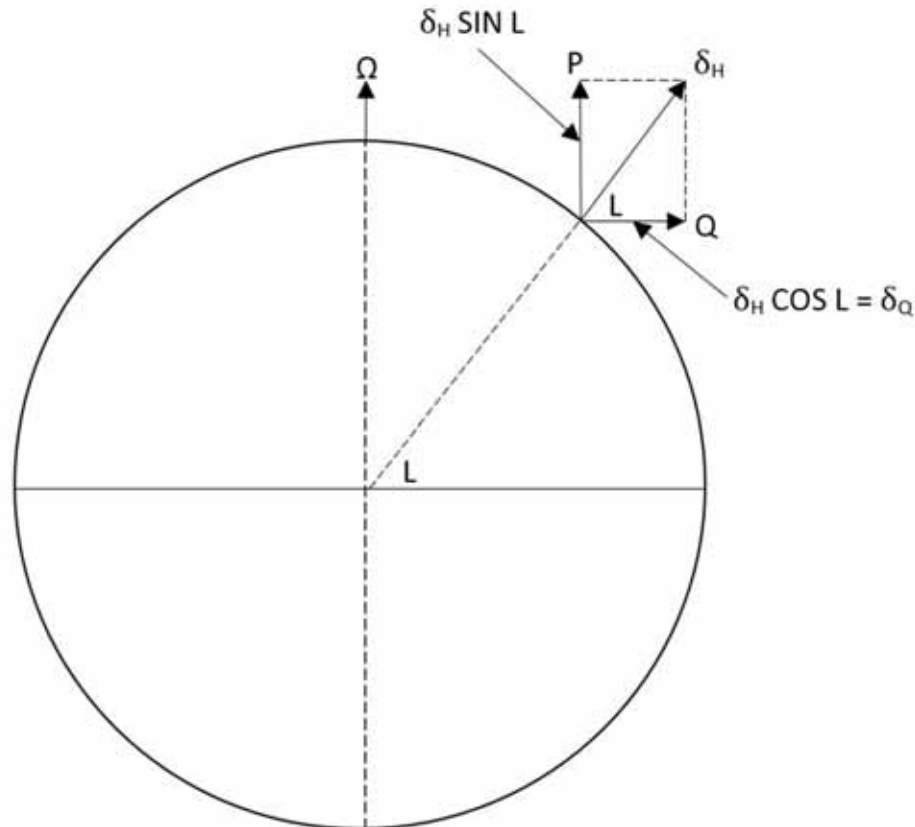

Figure 2019b. Relationship among misalignment errors of inertial navigator. Courtesy of Michelle C. Greiner, Johns Hopkins University - Applied Physics Laboratory.

In the 24-hour oscillation, the maximum δ_Q occurs 6 hours after the maximum δ_E and the two have equal magnitude. The heading error (δ_H) is in phase with δ_Q , but $\delta_H = \delta_Q \sec L$. Therefore, the 24-hour oscillation when present appears in the latitude, heading, and longitude outputs of the inertial navigator with the following relationships as shown in Figure 2019c.

1. The latitude error equals δ_E .
2. The heading error equals $\delta_Q \sec L$.
3. The longitude error equals $\delta_H \sin L$ or $\delta_Q \tan L$.
4. Latitude, heading, and longitude errors oscillate as a sine wave with a 24-hour period.
5. The latitude error leads the heading error by 6 hours or 90° .
6. The heading error and longitude error oscillations are in phase.
7. The maximum heading error equals the maximum latitude error multiplied by the secant of the latitude position.
8. The maximum longitude error equals the maximum latitude error multiplied by the tangent of the latitude position.

Since heading error is a function of latitude, the usual practice is to use a normalized heading value for the plotting of this error. This is accomplished by multiplying the heading error by the cosine of the latitude position. This results in a plot of δ_Q . The δ_Q curve is equal in amplitude to

the δ_L curve.

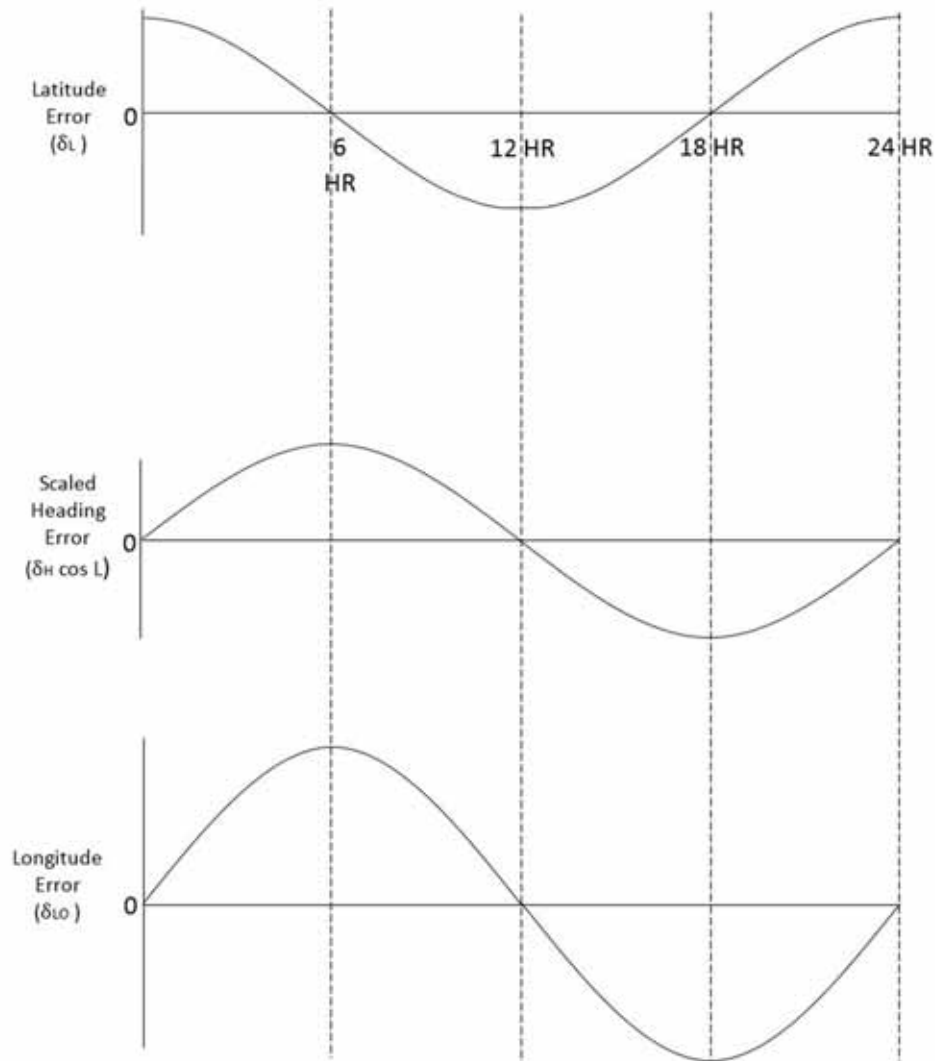

Figure 2019c. Inertial navigator 24-hour oscillation error plots. Courtesy of Michelle C. Greiner, Johns Hopkins University - Applied Physics Laboratory.

2020. Position Offsets

Position offset errors cause the INS to operate about a non-zero mean error value in position or heading. They can be introduced into the system by operating in areas with significant vertical deflection (Section 2014), in which case the value of the induced bias will be equal to the angular offset of gravity from the vertical at that point. They can also be caused by uncompensated gyro drifts. The example below shows how an uncompensated gyro drift can cause a position offset. In this example, it is assumed that the system is “settled,” meaning there is no earth loop oscillation present in the INS output.

A gyro drift is an internal disturbance which causes an output signal from the gyroscope. In gimballed systems, the stabilization loop interprets it as a disturbance of the stable

element's orientation and drives the gimbals accordingly. This causes a misorientation of the stable element and results in inertial navigator errors. Although the drift cannot be completely removed, it is possible to compensate for it by applying a gyro torquing signal called a bias. If the bias is proper, there is no gyroscope output due to drift. If the gyro bias is not correct or whenever the drift of a gyroscope changes and a new bias is needed, then there is a gyro bias error or a gyroscope with uncompensated drift. Strapdown sensors perform the equivalent functions described above algorithmically rather than mechanically.

Although the gyroscopes are placed physically in the inertial navigator's coordinate system (X, Y, Z), the effect of gyro bias errors is better described in terms of the equatorial coordinate system (P, Q, E). Using hypothetical gyroscopes in this coordinate system makes the analysis simpler. When

completed, the results can be transferred into the physical gyroscope coordinates by using the relationships given in Section 2017. The X , Y , and Z gyroscopes have P , Q , and E uncompensated drift rate components (δ_{BP} , δ_{BQ} and δ_{BE}).

Considering that the inertial navigator is a model of the earth and assuming that there is no movement with respect to the earth of the craft in which the navigator is installed, then the only motion of the navigator in space is about its

polar axis at earth rate. However, if the equatorial gyroscope has a bias error, δ_{BQ} , then there is an additional rotation about this axis in space. The navigator will then rotate in space about the vector sum of these two rotations. This causes the instrumented polar axis of the navigator indicated as P'' to be displaced about the east axis as shown at A in Figure 2020a.

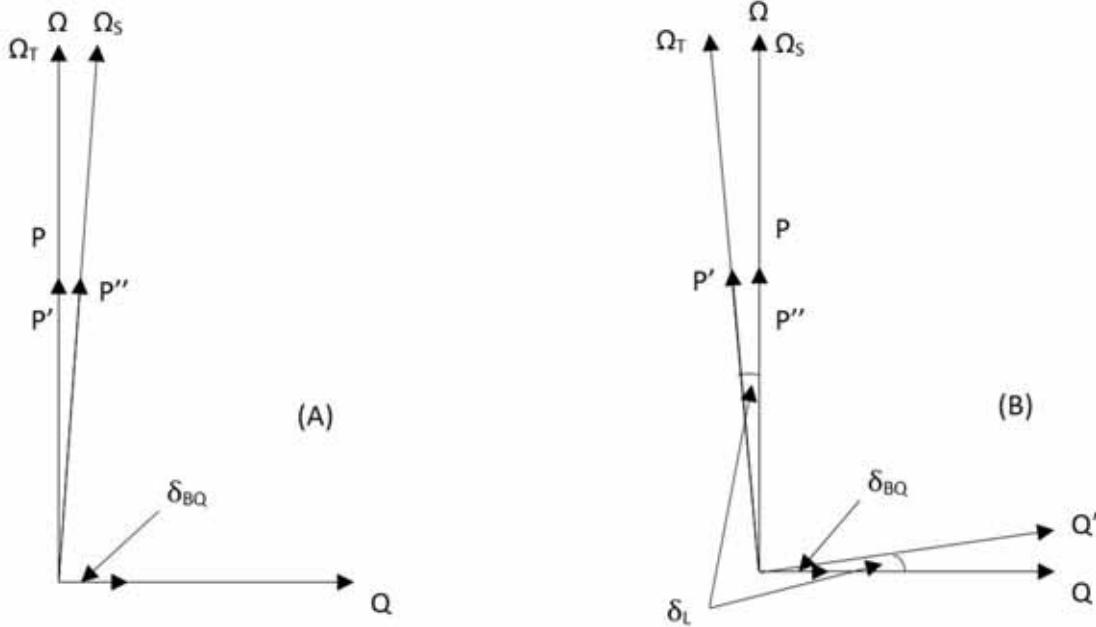

Figure 2020a. Effects of equatorial gyro bias error. Courtesy of Michelle C. Greiner, Johns Hopkins University - Applied Physics Laboratory.

Figure 2020a shows that the reference coordinates of the inertial navigator are aligned with the earth's coordinates. This means that earth rate torquing in the navigator (Ω_T) is applied about an axis parallel to the earth's spin axis. However, the navigator is rotating at earth rate (shown by Ω_S , S for actual rotation of navigator) about P'' due to δ_{BQ} . If left this way the equatorial gyro bias error would cause a 24-hour oscillation. To achieve a settled system with the equatorial gyro bias error, δ_{BQ} , the instrumented polar axis, P'' , must be made to coincide with the earth's spin axis. This is accomplished by a latitude error or δ_L as shown at B in Figure 2020a. The amount of latitude error needed to settle the system is related to the equatorial gyro bias error by the following relationship:

$$\delta_E = \delta_L = \frac{\delta_{BQ}}{\Omega}$$

View B of Figure 2020a shows the earth rate torquing

(Ω_T) of the navigator being applied about the displaced P'' axis. However, the δ_{BQ} about the displaced Q axis (Q') causes the navigator to rotate at earth rate (Ω_S) about the P'' axis which is now aligned to the earth's spin axis (P). If there is an equatorial gyro bias error present but the navigator is not settled, then the 24-hour oscillation occurs not about zero error but about a latitude error given in the above relationship. As a result an equatorial gyro bias error results in an offset or constant error in latitude which may or may not have a 24-hour oscillation superimposed upon it. The equatorial gyro bias error defines the settling point for latitude.

In the case of an east gyro bias error, δ_{BE} , the instrumented polar axis would be displaced about the equatorial axis. Again, to settle the navigator with an east gyro bias error, the instrumented polar axis must be made coincident with the earth's spin axis. To do this the navigator coordinates must be misaligned about the equatorial axis an amount given by:

$$\delta_Q = \delta_H \cos L = \frac{\delta_{BE}}{\Omega}$$

If the displacement about the equatorial axis is the above amount, the navigator would be settled. The δ_Q results in a heading error which varies as a function of latitude as discussed with respect to the 24-hour oscillation. If the navigator is not settled and has an east gyro bias error, the 24-hour oscillation in heading will be about an offset error defined by the above equation. If heading error times the cosine of latitude is plotted for a given east gyro bias error, this offset is constant and is a function of the magnitude of the gyro bias error.

If there is both an equatorial and east gyro bias error, there is a settling point for the navigator involving both a latitude error and a heading error. Figure 2020b illustrates the error propagation in an inertial navigator which had no errors previous to time 0 and then at time zero a bias error occurs in each of the gyros. View A shows that the latitude error oscillates about a value determined by the equatorial gyro bias error (the stand-off error in latitude due to an equatorial gyro bias error). The heading error as seen at view B oscillates about the stand-off error due to the east gyro bias error. The phase relationship is as discussed earlier and the magnitude of the 24-hour oscillation errors is a function of the initial conditions of the navigator.

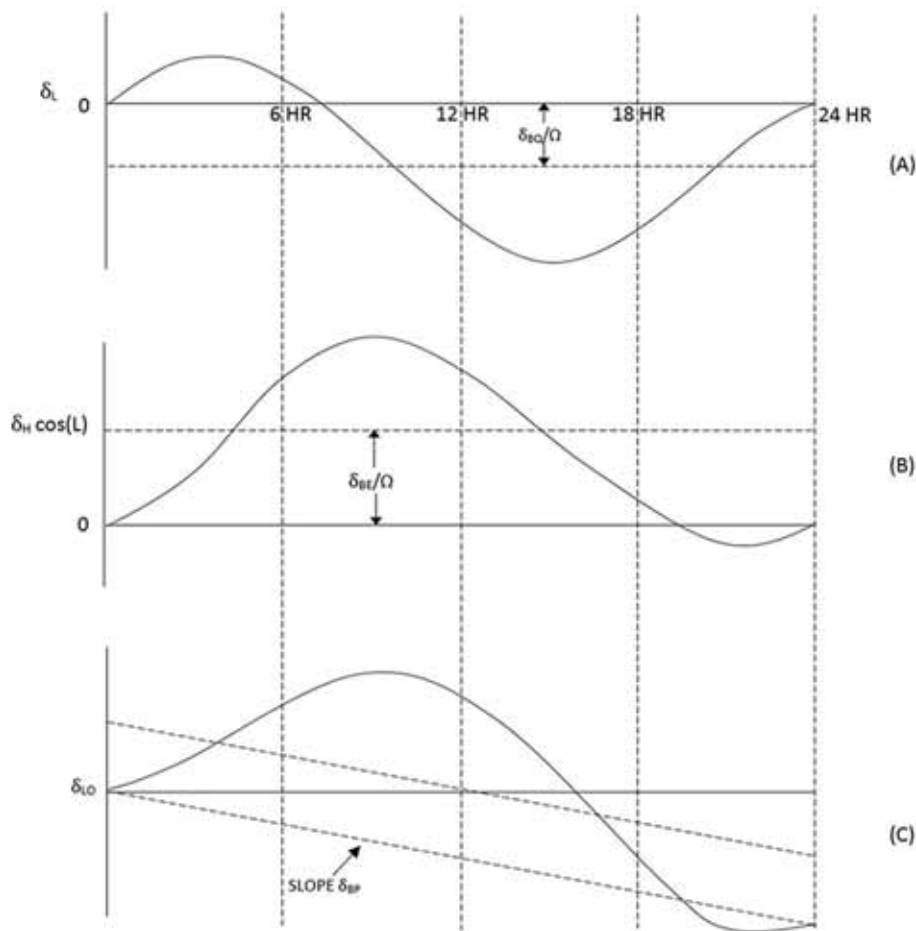

Figure 2020b. Inertial navigator error plots. Courtesy of Michelle C. Greiner, Johns Hopkins University - Applied Physics Laboratory.

2021. Longitude Ramps

Longitude ramps are another error feature that can be caused by a gyro bias error, this time in the polar gyro. Since this bias error occurs about the earth's spin axis, it doesn't change the orientation of the inertial navigator's instrumented polar axis. Instead the polar gyro bias error

causes the navigator to rotate about the polar axis at a rate different from the earth's rotation. The navigator interprets this as change of position on the earth about the polar axis which is longitude change or longitude rate. The bias error has a constant value, resulting in a constant longitude rate error. The longitude rate is integrated with time in the navigator to produce an increasing longitude value. As a result

the polar gyro bias error contributes a straight line function to the longitude error. The slope of this line equals the polar gyro bias error or longitude ramp.

View *C* of Figure 2020b shows the longitude error at latitude 45°N. The longitude error starts at zero in this case

because of the initial conditions previously set up. The longitude error oscillates relative to the polar gyro bias error in the same phase as the heading error oscillates about the latitude gyro bias error.

CONTROLLING INERTIAL NAVIGATION SYSTEM ERRORS

2022. Controlling Inertial Navigation System Errors

Every INS will output navigation parameters (position, velocity attitude) with errors; thus, provisions and mechanisms are included to reduce or bound errors. Prudent navigators will understand the limitations of their INS, the inherent errors expected, and the options available to opti-

mize INS performance and the methods to reduce or bound INS errors. INS errors are controlled by calibration of the inertial sensors, and the use of various navigation aids for damping and resetting the inertial sensors. The following sections describe the methods or compensations for common error sources.

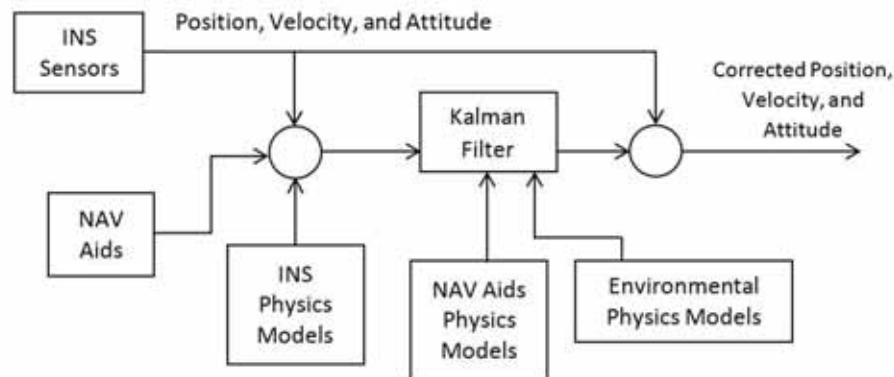

Figure 2022. Block diagram of Kalman Filter inputs. Courtesy of Michelle C. Greiner, Johns Hopkins University - Applied Physics Laboratory.

Integration of these navigation aids with an inertial navigator can take many forms; however, many modern systems make use of Kalman Filtering (Figure 2022) to control INS errors. The subject of Kalman Filtering is beyond the scope of this section. However, at its basic level, a Kalman Filter models the inertial navigation system as a linear system of states, where each state represents position, velocity, attitude, gyroscope, and accelerometer errors. The Kalman Filter also models the measurement errors of the navigation aiding sensors and any environmental errors that affect the inertial navigation system. The Kalman Filter estimates the inertial navigation system errors. These estimates are then used to correct and control the error and error growth of the inertial navigation system.

2023. Calibration

Errors in an inertial navigation system's accelerometers and gyroscopes will significantly impact the system's navigation performance. An INS that is considered *free inertial* is a system in which these errors are allowed to integrate into the velocity and position unbounded. Typically, however, inertial navigators employ methods to calibrate, estimate,

and control these sensor errors.

For platforms that use gimbals, the calibration can take the form of inducing motions into the platform to make the inertial sensor errors observable. This typically is conducted upon system startup and includes inducing known rotations or known orientations of the platform and measuring the inertial sensor outputs. Since the inputs to the inertial sensors are known to a reasonable level, the difference between the reported output of the sensor and the true known input from the sensor provides an estimate of the sensor error. Calibration provides estimates of sensor biases, misalignments, scale factors and noise parameters that are then used to interpret the signals from the inertial sensors. There are a variety of techniques which are employed depending on the exact nature of the sensor errors, the intended application, and the capabilities of the gimballed system.

For strapdown systems, initialization will likely include both stationary operations, and specified ship motion calibrations that require large angle turns or course reversals, along with continuous GPS or other fix sources. Strapdown INSs are much more dependent on inputs from accurate external fix and damping sources to maintain nav-

igation accuracy than are gimbaled systems.

2024. Damping

Damping refers to the process of reducing the amplitude of an oscillation. In an INS, damping is used to control the Schuler errors. In order to reduce the amplitude of the oscillation, the sensed velocity caused by the gravity acceleration must be separated from the actual velocity of the craft. The error can then be subtracted from the accelerometer signal, leaving a signal that reflects the true craft

motion.

To distinguish between the actual craft velocity and the oscillating velocity error, a secondary source of craft velocity must be used. The secondary source must be unrelated to the accelerometers and unaffected by gravity, such as GPS or a water speed log. By subtracting this secondary reference velocity from the accelerometer-derived velocity output, the actual craft velocity is canceled out, leaving only the error. This error component, then, can be subtracted from the accelerometer output.

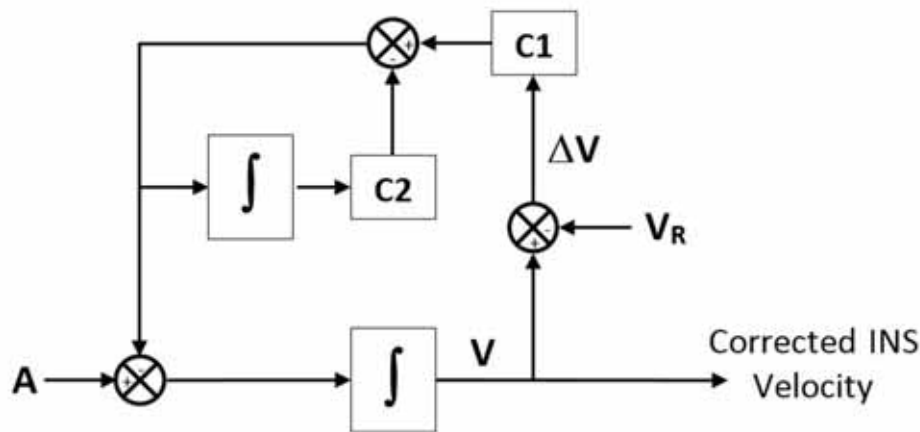

Figure 2024a. Third-order damping loop. Courtesy of Michelle C. Greiner, Johns Hopkins University - Applied Physics Laboratory.

Figure 2024a is an example of a simple third-order damping loop. The accelerometer output, A , is integrated into a velocity, V , from which the reference velocity, V_R , is subtracted. This subtraction yields the difference between the two signals, ΔV . The difference is multiplied by the damping coefficient, $C1$, which specifies how much of the signal to feed back to the accelerometer output.

If the reference velocity includes a constant error in speed over ground, such as might occur when using a water speed sensor in a constant current, then ΔV will also contain that error. If this reference velocity error is fed back to the accelerometer output, it will lead to a bias in the INS-derived positions and velocities. Thus, it is desirable to remove any constant bias from the damping signal before applying it to the accelerometer output. This is accomplished by sending the signal through a second integrator and subtracting a portion (determined by the damping coefficient $C2$) from the original damping signal. The resulting signal is subtracted from the accelerometer output.

Another damping technique is to use a Kalman filter to perform velocity and associated position and alignment state “resets” based on the difference between inertial and reference velocity. This technique is usually known as Kalman (or discrete) damping. Similar to third-order damping, Kalman damping can also account for constant differences

between inertial and reference velocity. Additionally, Kalman damping uses an error model to attempt to estimate system errors better. Since a Schuler-tuned system oscillates with an (approximate) 84-minute period whenever it is disturbed, a filter can be designed based on this fact to correct velocity and tilt errors caused by Schuler errors very rapidly.

While both third-order and Kalman damping are designed to handle constant biases in the reference velocity, unexpected or unmodeled changes in either the inertial or reference velocities will still cause errors to develop in the system. Thus, it is advisable to operate the system “undamped” when the reference velocity is known to be disturbed, such as when using a water speed log in a changing current or in any case the reference velocity output is suspect. In addition, when operating in areas of uncompensated VD, any form of damping that adjusts the underlying system error model (such as Kalman damping) should be avoided. Third-order damping is appropriate when in high-VD areas.

While the horizontal Schuler errors in INSs are oscillatory, gravity-induced vertical errors in an INS output are inherently unstable (small errors in vertical velocity lead to *increasing* errors, rather than oscillatory errors). Thus, the vertical velocity channel requires essentially continuous

damping in order to maintain reasonable outputs. For a vessel on the surface of the ocean, vertical velocity can be damped to a reference of 0. For submarines, vertical reference velocity can be provided by a depth detector, whereas aircraft may use a barometer to provide this input.

2025. Reset

A reset, or fix-reset, is the mathematical process in an INS in which external position information, such as from GPS, is compared with the INS output and the resulting difference is used to estimate the INS sensor errors remaining in the system. A fix-reset can be thought of as a mini-calibration of the INS. A Kalman filter, modeling the major errors, is used to process the position fix information to re-estimate the known errors (such as gyro bias and drifts) to improve the future estimate of the navigation parameters. At the same time, a correction is applied to the inertial navigator's current position output. The process of entering these corrections into the navigator for this purpose is called a **reset**.

The effect of a reset is threefold: it will immediately reduce the INS errors in position, velocity and attitude; it will improve long term estimation of future errors and thus reduce navigation errors until the next fix-reset; and it will

reduce its own internal estimate of uncertainty which will impact the weight applied to future fix-resets (a function of time and fix quality, as well as the internal estimate of the historical error growth).

Position resets are most effective when they are inserted at the peak of the earth loop errors; however, even without knowing when these errors are at a maximum, resets can be effective if timed correctly. Resets should be spaced such that different magnitudes of error on the unknown oscillation will be adjusted each time. Earth loop oscillations reach their maximums-and likewise, minimums-in 12-hour intervals, meaning that 12 hours from now, the error will be of the same magnitude as it is now. Thus, resetting at 12-hour intervals (or multiples thereof) is discouraged, because if the magnitude of the error is small at that point, then repeatedly resetting the same small error will have little long-term effect on navigator performance. Rather, reset intervals of 12 + 2 hours would guarantee that some of the time, resets would be inserted when the error is large. Figure 2025 illustrates the variation in position error observed at 10-hour intervals, compared to the error at 12-hour intervals. In addition, navigators should ensure that large Schuler errors are not apparent, and that the vessel is not in an area of very high vertical deflection at the time of the reset.

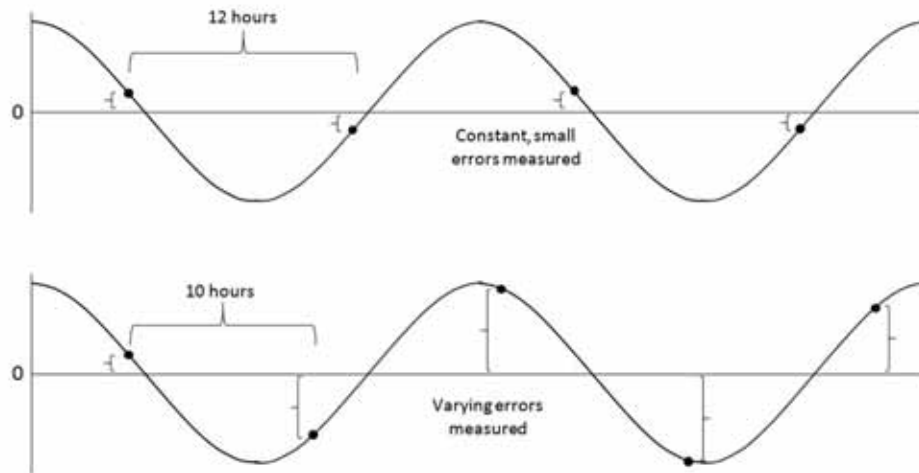

Figure 2025. Variation in error magnitude over different timing intervals. Courtesy of Michelle C. Greiner, Johns Hopkins University - Applied Physics Laboratory.

Platforms with continuous access to GPS often reset their inertial navigation systems continuously. The advantage is that the INS remains aligned to GPS and the accelerometers and gyroscopes can achieve additional calibration and performance grooming. The disadvantage is that the navigator is unaware of the true performance of their INS when GPS is lost, and may result in a false sense of security in the INS.

The navigator should remember that while the fix-reset process will initially eliminate or reduce errors, the errors

will commence growing again following the reset. The rate of error growth will be based on the quality and frequency of the resets. The longer the time from a fix-reset, the greater the uncertainty of the output solution based on the inherent qualities of the sensors.

2026. References

Britting, K. R., (1971). *Inertial Navigation Systems Analysis*. New York: John Wiley & Sons, Inc.,

Lawrence, A., (1993). *Modern Inertial Technology*.
New York: Springer-Verlag New York, Inc.

Titterton, D. H. and Weston, J. L. (1997). *Strapdown
inertial navigation technology*. London: Peter Peregrinus,
Ltd.

CHAPTER 21

RADIO WAVES

ELECTROMAGNETIC WAVE PROPAGATION

2100. Source of Radio Waves

Consider electric current as a flow of electrons through a conductor between points of differing potential/voltage/electric field. A **direct current** flows continuously in one direction. This occurs when the polarity of the electromotive force (EMF, or voltage) causing the electron flow is constant, such as is the case with a battery. If, however, the current is induced by the relative motion between a conductor and a magnetic field, as is the case in a rotating machine (**motor/generator**) or an **electrical oscillator**, signal generator, or **radio transmitter**, then the resulting current changes direction in the conductor as the polarity of the electromotive force changes with a period (or frequency) that ranges from fractions of a hertz (cycles per second) to hundreds of billions of hertz (i.e., gigahertz). This is known as **alternating current**.

The energy contained in the current flowing through the conductor due to a gradient of voltage is either dissipated as heat (an energy loss proportional to both the current flowing through the conductor and the conductor's resistance) or stored in an electromagnetic field oriented symmetrically about the conductor. The orientation of this field is a function of the polarity of the source producing the current. When the current is removed from the conductor, this electromagnetic field will, after a finite time associated with the speed of light, collapse back into the conductor.

What would occur should the polarity of the current source supplying the wire be reversed at a rate which exceeds the finite amount of time required for the electromagnetic field to collapse back upon the wire? In this case, another magnetic field, proportional in strength but exactly opposite in magnetic orientation to the initial field, sometimes referred to as a "back EMF," particularly when associated with an inductor or coil, will be formed upon the wire. This time-varying behavior of the combined electric and magnetic fields creates an electromagnetic wave that propagates, according to Maxwell's famous equations, into space. This is the basic principle of a radio antenna, which transmits a wave at a frequency proportional to the rate of current reversal and at a speed equal, in vacuum, to the speed of light. In materials, such as the dielectrics associated with coaxial cables, the waves travel at a velocity that can be considerably slower than the speed of light in vacuum.

2101. Radio Wave Terminology

The magnetic field strength in the vicinity of a conductor is directly proportional to the magnitude of the current flowing through the conductor. Recall the discussion of alternating current above. A rotating generator produces current in the form of a sine wave. That is, the magnitude of the current varies as a function of the relative position of the rotating conductor and the stationary magnetic field used to induce the current. The current starts at zero, increases to a maximum as the rotor completes one quarter of its revolution, and falls to zero when the rotor completes one half of its revolution. The current then approaches a negative maximum; then it once again returns to zero. This cycle can be represented by a sinusoidal function of time. Note that the electromagnetic waves described above can be represented as sinusoidal functions of both time and position.

The relationship between the current and the magnetic field strength induced in the conductor through which the current is flowing is shown in Figure 2101. Recall from the discussion above that this field strength is proportional to the magnitude of the current; that is, if the current is represented by a sine wave function, then so too will be the magnetic field strength resulting from that current. This characteristic shape of the field strength curve has led to the use of the term "wave" when referring to electromagnetic propagation. The maximum displacement of a peak from zero is called the

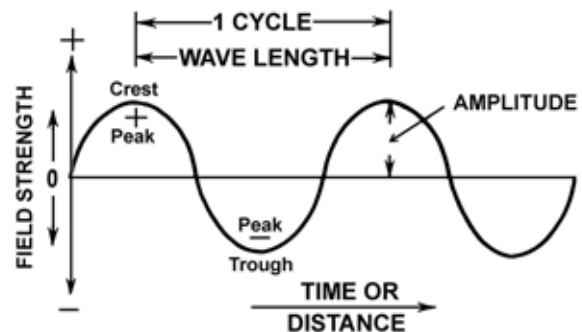

Figure 2101. Radio wave terminology.

amplitude. The forward side of any wave is called the **wave front.** For a non-directional antenna, each wave proceeds outward as an expanding sphere (or hemisphere).

One **cycle** is a complete sequence of values, as from crest to crest. The distance traveled by the energy during one cycle is the **wavelength**, usually expressed in metric units (meters, centimeters, etc.). The number of cycles repeated during unit time (usually 1 second) is the **frequency.** This is given in **hertz** (cycles per second). A kilohertz (kHz) is 1,000 cycles per second. A megahertz (MHz) is 1,000,000 cycles per second. Wavelength and frequency are inversely proportional.

The **phase** of a wave is the amount by which the cycle has progressed from a specified origin of time or position.

For most purposes it is stated in radians or degrees, a complete cycle being considered 360°. Generally, the origin is not important, with the principal interest being the phase relative to that of some other wave. Thus, two waves having crests 1/4 cycle apart are said to be 90° “out of phase,” often being referred to as being in “phase quadrature”. If the crest of one wave occurs at the trough of another, the two are 180° out of phase, and are of “opposite polarity.”

2102. The Electromagnetic Spectrum

The entire range of electromagnetic radiation frequen-

Band	Abbreviation	Range of frequency	Range of wavelength
Audio frequency	AF	20 to 20,000 Hz	15,000,000 to 15,000 m
Radio frequency	RF	10 kHz to 300,000 MHz	30,000 m to 0.1 cm
Very low frequency	VLF	10 to 30 kHz	30,000 to 10,000 m
Low frequency	LF	30 to 300 kHz	10,000 to 1,000 m
Medium frequency	MF	300 to 3,000 kHz	1,000 to 100 m
High frequency	HF	3 to 30 MHz	100 to 10 m
Very high frequency	VHF	30 to 300 MHz	10 to 1 m
Ultra high frequency	UHF	300 to 3,000 MHz	100 to 10 cm
Super high frequency	SHF	3,000 to 30,000 MHz	10 to 1 cm
Extremely high frequency	EHF	30,000 to 300,000 MHz	1 to 0.1 cm
Heat and infrared		10^6 to 3.9×10^8 MHz*	0.03 to 7.6×10^{-5} cm*
Visible spectrum		3.9×10^8 to 7.9×10^8 MHz*	7.6×10^{-5} to 3.8×10^{-5} cm*
Ultraviolet		7.9×10^8 to 2.3×10^{10} MHz*	3.8×10^{-5} to 1.3×10^{-6} cm*
X-rays		2.0×10^9 to 3.0×10^{13} MHz*	1.5×10^{-5} to 1.0×10^{-9} cm*
Gamma rays		2.3×10^{12} to 3.0×10^{14} MHz*	1.3×10^{-8} to 1.0×10^{-10} cm*
Cosmic rays		$>4.8 \times 10^{15}$ MHz	$<6.2 \times 10^{-12}$ cm

* values approximate.

Table 2102. Electromagnetic spectrum.

cies is called the **electromagnetic spectrum.** The frequency range suitable for radio transmission, the **radio spectrum**, extends from 10 kHz to 300,000 MHz, or 300 GHz. It is divided into a number of bands, as shown in Table 2102.

Below the radio spectrum, but overlapping it, is the audio frequency band, extending from 20 to 20,000 Hz. Above the radio spectrum are infrared (often associated

with heat), the visible spectrum (light in its various colors), ultraviolet, X-rays, gamma rays, and cosmic rays. These are included in Table 2102. Waves shorter than 30 centimeters are usually called **microwaves.**

Within the frequencies from 1 to 40 GHz (1,000 to 40,000 MHz), additional bands are defined as follows:

L-band: 1 to 2 GHz (1,000 to 2,000 MHz)

S-band: 2 to 4 GHz (2,000 to 4,000 MHz)

C-band: 4 to 8 GHz (4,000 to 8,000 MHz)

X-band: 8 to 12.5 GHz (8,000 to 12,500 MHz)

Lower K-band: 12.5 to 18 GHz (12,500 to 18,000 MHz)

Upper K-band: 26.5 to 40 GHz (26,500 to 40,000 MHz)

Marine radar systems commonly operate in the L, S and X bands, while satellite navigation system signals (e.g., GPS) are found in the L-band.

The break of the K-band into lower and upper ranges is necessary because the resonant frequency of water vapor occurs in the middle region of this band, and severe absorption of radio waves occurs in this part of the spectrum.

2103. Polarization

Radio waves produce both electric and magnetic fields. The direction of the electric component of the field is called the **polarization** of the electromagnetic field. Thus, if the electric component is vertical, the wave is said to be “vertically polarized,” and if horizontal, “horizontally polarized.” If the horizontal and vertical components of an electric field are equal, and in phase, the polarization is sometimes called “slant right” or “slant left”. If the two polarizations vary in phase by 90° , in either time or position, the polarization becomes left hand circularized or right hand circularized.

A radio wave traveling through space may be polarized in any direction. One traveling along the surface of the Earth is always vertically polarized because the Earth, a moderate conductor, “short-circuits” any horizontal component. The magnetic field and the electric field of an electromagnetic wave are always mutually perpendicular.

2104. Reflection

When radio waves strike a surface, the surface reflects them in the same manner as light waves. Radio waves of all frequencies are reflected by the surface of the Earth. The strength of the reflected wave depends upon angle of incidence (the angle between the incident ray and the horizontal), type of polarization, frequency, reflecting properties of the surface, and divergence of the reflected ray. Lower frequencies penetrate the Earth’s surface more than higher ones. At very low frequencies, usable radio signals can be received some distance below the surface of the sea.

A phase change occurs when a wave is reflected from the surface of the Earth. The amount of the change varies with the conductivity of the Earth and the polarization of the wave, reaching a maximum of 180° for a horizontally polarized wave reflected from sea water (considered to

have infinite conductivity).

When direct waves (those traveling from transmitter to receiver in a relatively straight line, without reflection) and reflected waves arrive at a receiver, the total signal is the vector sum of the two. If the signals are in phase, they reinforce each other, producing a stronger signal. If there is a phase difference, the signals tend to cancel each other, the cancellation being complete if the phase difference is 180° and the two signals have the same amplitude. This interaction of waves is called **wave interference**, and the reflected wave is called a **multipath wave**.

A phase difference may occur because of the change of phase of a reflected wave, or because of the longer path it follows. The second effect decreases with greater distance between transmitter and receiver, for under these conditions the difference in path lengths is smaller.

At lower frequencies there is no practical solution to interference caused in this way. For VHF and higher frequencies, the condition can be improved by elevating the antenna, if the wave is vertically polarized. Additionally, interference at higher frequencies can be more nearly eliminated because of the greater ease of beaming the signal to avoid reflection.

Reflections may also occur from mountains, trees, and other obstacles. Such reflection is negligible for lower frequencies, but becomes more prevalent as frequency increases. In radio communication, it can be reduced by using directional antennas, but this solution is not always available for navigational systems.

Various reflecting surfaces occur in the atmosphere. At high frequencies, reflections take place from rain. At still higher frequencies, reflections are possible from clouds, particularly rain clouds. Reflections may even occur at a sharply defined boundary surface between air masses, as when warm, moist air flows over cold, dry air. When such a surface is roughly parallel to the surface of the Earth, radio waves may travel for greater distances than normal. The principal source of reflection in the atmosphere is the ionosphere.



Figure 2104a. Specular reflection.

Figure 2104a and Figure 2104b show, at optical fre-



Figure 2104b. Specular reflection from bird bath.

quencies (i.e., light), the reflection of electromagnetic waves from water. The first figure shows direct and the reflected views of the sun, in this case known as specular reflection. The reflection of the sun is evident in even a small body of water, in this case a bird-bath. Radio waves exhibit this same behavior.

2105. Refraction

Refraction of radio waves is similar to that of light waves. Thus, as a signal passes from air of one density to that of a different density, the direction of travel is altered. The principal cause of refraction in the atmosphere is the difference in temperature and pressure occurring at various heights and in different air masses of different densities.

Refraction occurs at all frequencies, but below 30 MHz the effect is small as compared with ionospheric effects, diffraction, and absorption. At higher frequencies, refraction in the lower layer of the atmosphere extends the radio horizon to a distance about 15 percent greater than the visible horizon. The effect is the same as if the radius of the Earth were about one-third greater than it is and there were no refraction.

Sometimes the lower portion of the atmosphere becomes stratified. This stratification results in nonstandard temperature and moisture changes with height. If there is a marked temperature inversion or a sharp decrease in water vapor content with increased height, a horizontal radio duct may be formed. High frequency radio waves traveling horizontally within the duct are refracted to such an extent that they remain within the duct, following the curvature of the Earth for phenomenal distances. This is called **super-refraction**. Maximum results are obtained when both transmitting and receiving antennas are within the duct. There is a lower limit to the frequency affected by ducts. It varies from about 200 MHz to more than 1,000 MHz.

At night, surface ducts may occur over land due to cooling of the surface. At sea, surface ducts about 50 feet thick may occur at any time in the trade wind belt. Surface ducts 100 feet or more in thickness may extend from land out to sea when warm air from the land flows over the cooler ocean surface. Elevated ducts from a few feet to more than 1,000 feet in thickness may occur at elevations of 1,000 to 5,000 feet, due to the settling of a large air mass. This is a frequent occurrence in Southern California and certain areas of the Pacific Ocean.

A bending in the horizontal plane occurs when a groundwave crosses a coast at an oblique angle. This is due to a marked difference in the conducting and reflecting properties of the land and water over which the wave travels. The effect is known as **coastal refraction** or **land effect**.

2106. The Ionosphere

Since an atom normally has an equal number of negatively charged electrons and positively charged protons, it is electrically neutral. An **ion** is an atom or group of atoms which has become electrically charged, either positively or negatively, by the loss or gain of one or more electrons.

Loss of electrons may occur in a variety of ways. In the atmosphere, ions are usually formed by collision of atoms with rapidly moving particles, or by the action of cosmic rays or ultraviolet light. In the lower portion of the atmosphere, recombination soon occurs, leaving a small percentage of ions. In "thin" atmosphere far above the surface of the Earth, where the air pressure is considerably lower than that at sea level, atoms are widely separated and a large number of ions may be present. The region of numerous positive and negative ions and unattached electrons is called the **ionosphere**. The extent of ionization depends upon the kinds of atoms present in the atmosphere, the density of the atmosphere, and the position relative to the sun (time of day and season). After sunset, ions and electrons recombine faster than they are separated, decreasing the ionization of the atmosphere.

An electron can be separated from its atom only by the application of greater energy than that holding the electron. Since the energy of the electron depends primarily upon the kind of an atom of which it is a part, and its position relative to the nucleus of that atom, different kinds of radiation may cause ionization of different substances.

In the outermost regions of the atmosphere, the density is so low that oxygen exists largely as separate atoms, rather than combining as molecules as it does nearer the surface of the Earth. At great heights the energy level is low and ionization from solar radiation is intense. This is known as the **F layer**. Above this level the ionization decreases because of the lack of atoms to be ionized. Below this level it decreases because the ionizing agent of appropriate energy has already been absorbed. During daylight, two levels of maximum F ionization can be detected, the F₂

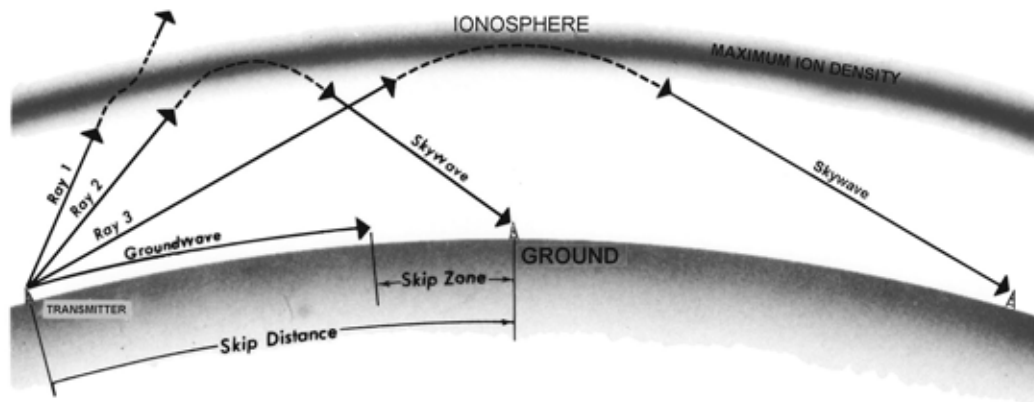

Figure 2106. The effect of the ionosphere on radio waves.

layer at about 125 statute miles above the surface of the Earth, and the F_1 layer at about 90 statute miles. At night, these combine to form a single F layer.

At a height of about 60 statute miles, the solar radiation not absorbed by the F layer encounters, for the first time, large numbers of oxygen molecules. A new maximum ionization occurs, known as the **E layer**. The height of this layer is quite constant, in contrast with the fluctuating F layer. At night the E layer becomes weaker by two orders of magnitude.

Below the E layer, a weak D layer forms at a height of about 45 statute miles, where the incoming radiation encounters ozone for the first time. The D layer is the principal source of absorption of HF waves, and of reflection of LF and VLF waves during daylight.

2107. The Ionosphere and Radio Waves

When a radio wave encounters an atom or molecule having an electric charge, it causes that atom/molecule to vibrate. The vibrating particle absorbs electromagnetic energy from the radio wave and can re-radiate it. The net effect is a change of polarization and an alteration of the path of the wave. That portion of the wave in a more highly ionized region travels faster, causing the wave front to tilt and the wave to be directed toward a region of less intense ionization.

Refer to Figure 2106, in which a single layer of the ionosphere is considered. Ray 1 enters the ionosphere at such an angle that its path is altered, but it passes through and proceeds outward into space. As the angle with the horizontal decreases, a critical value is reached where ray 2 is bent or reflected back toward the Earth. As the angle is still further decreased, such as at ray 3, the return to Earth occurs at a greater distance from the transmitter.

A wave reaching a receiver by way of the ionosphere is called a **skywave**. This expression is also appropriately applied to a wave reflected from an air/mass boundary. In

common usage, however, it is generally associated with the ionosphere. The wave which travels along the surface of the Earth is called a **groundwave**. At angles greater than the critical angle, no skywave signal is received. Therefore, there is a minimum distance from the transmitter at which sky waves can be received. This is called the **skip distance**, shown in Figure 2106. If the groundwave extends for less distance than the skip distance, a skip zone occurs, in which no usable signal is received.

The critical radiation angle depends upon the intensity of ionization, and the frequency of the radio wave. As the frequency increases, the angle becomes smaller. At frequencies greater than about 30 MHz, virtually all of the energy penetrates through or is absorbed by the ionosphere. Therefore, at any given receiver there is a maximum usable frequency if sky waves are to be utilized. The strongest signals are received at or slightly below this frequency. There is also a lower practical frequency beyond which signals are too weak to be of value. Within this band the optimum frequency can be selected to give best results. It cannot be too near the maximum usable frequency because this frequency fluctuates with changes of intensity within the ionosphere. During magnetic storms the ionosphere density decreases. The maximum usable frequency decreases, and the lower usable frequency increases. The band of usable frequencies is thus narrowed. Under extreme conditions it may be completely eliminated, isolating the radio receiver and causing a radio blackout.

Skywave signals reaching a given receiver may arrive by any of several paths, as shown in Figure 2107. A signal which undergoes a single reflection is called a "one-hop" signal, one which undergoes two reflections with a ground reflection between is called a "two-hop" signal, etc. A "multi-hop" signal undergoes several reflections. The layer at which the reflection occurs is usually indicated, also, as "one-hop E," "two-hop F," etc.

Because of the different paths and phase changes oc-

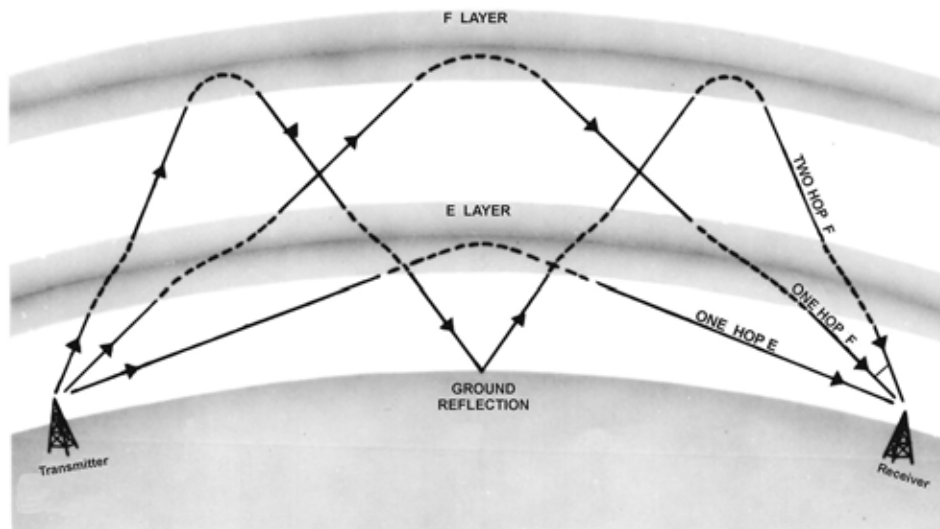

Figure 2107. Various paths by which a skywave signal might be received.

curing at each reflection, the various signals arriving at a receiver have different phase relationships. Since the density of the ionosphere is continually fluctuating, the strength and phase relationships of the various signals may undergo an almost continuous change. Thus, the various signals may reinforce each other at one moment and cancel each other at the next, resulting in fluctuations of the strength of the total signal received. This is called **fading**. This phenomenon may also be caused by interaction of components within a single reflected wave, or changes in its strength due to changes in the reflecting surface. Ionospheric changes are associated with fluctuations in the radiation received from the sun, since this is the principal cause of ionization. Signals from the F layer are particularly erratic because of the rapidly fluctuating conditions within the layer itself.

The maximum distance at which a one-hop E signal can be received is about 1,400 miles. At this distance the signal leaves the transmitter in approximately a horizontal direction. A one-hop F signal can be received out to about 2,500 miles. At low frequencies, ground waves extend out for great distances.

A skywave may undergo a change of polarization during reflection from the ionosphere, accompanied by an alteration in the direction of travel of the wave. This is called **polarization error**. Near sunrise and sunset, when rapid changes are occurring in the ionosphere, reception may become erratic and polarization error a maximum. This is called **night effect**.

2108. Diffraction

When a radio wave encounters an obstacle, its energy is reflected or absorbed, causing a shadow beyond the obstacle. However, some energy does enter the shadow area because of diffraction. This is explained by Huygens' principle, which states that every point on the surface of a wave front is a source of radiation, transmitting energy in all directions ahead of the

wave. No noticeable effect of this principle is observed until the wave front encounters an obstacle, which intercepts a portion of the wave. From the edge of the obstacle, energy is radiated into the shadow area, and also outside of the area. The latter interacts with energy from other parts of the wave front, producing alternate bands in which the secondary radiation reinforces or tends to cancel the energy of the primary radiation. Thus, the practical effect of an obstacle is a greatly reduced signal strength in the shadow area, and a disturbed pattern for a short distance outside the shadow area. This is illustrated in Figure 2108.

The amount of diffraction is inversely proportional to the frequency, being greatest at very low frequencies.

2109. Absorption and Scattering

The amplitude of a radio wave's electric or magnetic field expanding outward through space varies inversely with distance, weakening with increased distance. The combined electric and magnetic fields yield the **power flux density**, or pfd, which varies in inverse proportion to the square of distance. The decrease of strength with distance, due to spherical spreading of the electromagnetic wave, is called **attenuation**. Under certain conditions, typically due to absorption of energy in air, the attenuation is greater than in free space.

A wave traveling along the surface of the Earth loses a certain amount of energy as the wave is diffracted downward and absorbed by the Earth. As a result of this absorption, the remainder of the wave front tilts downward, resulting in further absorption by the Earth. Attenuation is greater over a surface which is a poor conductor. Relatively little absorption occurs over sea water, which is an excellent conductor at low frequencies, and low frequency ground waves travel great distances over water.

A skywave suffers an attenuation loss in its encounter with the ionosphere. The amount depends upon the height

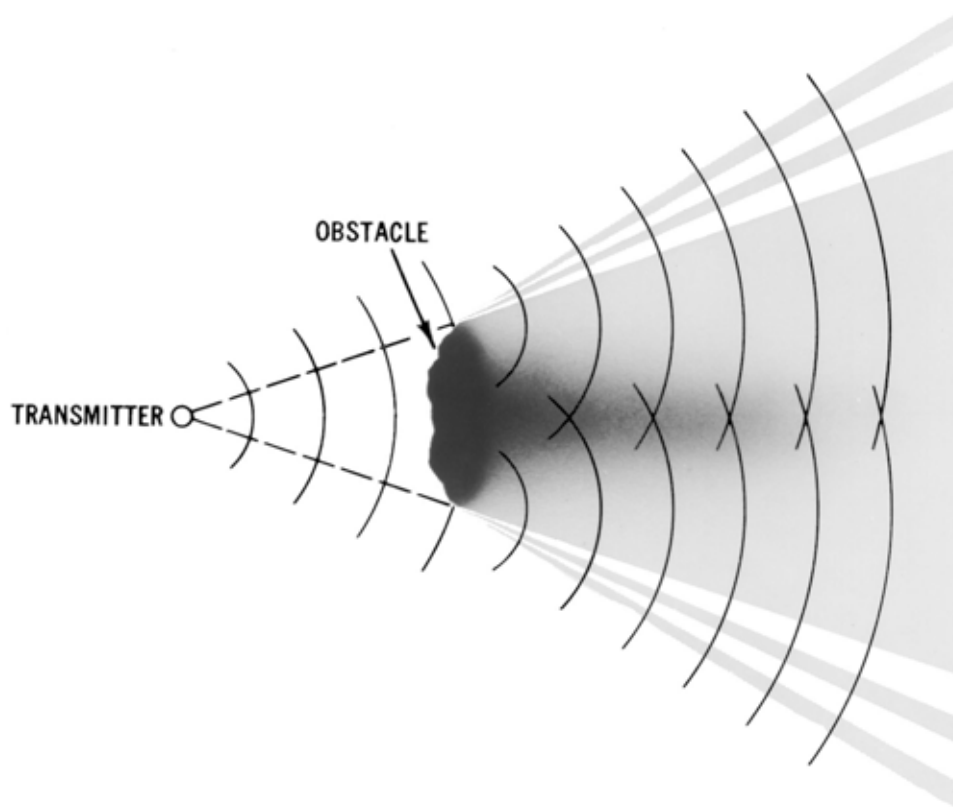

Figure 2108. Diffraction.

and composition of the ionosphere as well as the frequency of the radio wave. Maximum ionospheric absorption occurs at about 1,400 kHz.

In general, atmospheric absorption increases with frequency. It is a problem only in the SHF and EHF frequency range. At these frequencies, attenuation is further increased by scattering due to reflection by oxygen, water vapor, water droplets, and rain in the atmosphere.

2110. Noise

Unwanted signals in a receiver are called **interference**. The intentional production of such interference to obstruct communication is called **jamming**. Unintentional interference is called **noise**.

Noise may originate within the receiver. Hum is usually the result of induction from neighboring circuits carrying alternating current. Irregular crackling or sizzling sounds may be caused by poor contacts or faulty components within the receiver. Stray currents in normal components cause some noise. This source sets the ultimate limit of sensitivity that can be achieved in a receiver. It is the same at any frequency.

Noise originating outside the receiver may be either man-made or natural. Man-made noises originate in electrical appliances, motor and generator brushes, ignition

systems, and other sources of sparks which transmit electromagnetic signals that are picked up by the receiving antenna.

Natural noise is caused principally by discharge of static electricity in the atmosphere. This is called **atmospheric noise**, **atmospherics**, or **static**. An extreme example is a thunderstorm. An exposed surface may acquire a considerable charge of static electricity. This may be caused by friction of water or solid particles blown against or along such a surface. It may also be caused by splitting of a water droplet which strikes the surface, one part of the droplet requiring a positive charge and the other a negative charge. These charges may be transferred to the surface. The charge tends to gather at points and ridges of the conducting surface, and when it accumulates to a sufficient extent to overcome the insulating properties of the atmosphere, it discharges into the atmosphere. Under suitable conditions this becomes visible and is known as St. Elmo's fire, which is sometimes seen at mastheads, the ends of yardarms, etc.

Atmospheric noise occurs to some extent at all frequencies but decreases with higher frequencies. Above about 30 MHz it is not generally a problem.

2111. Antenna Characteristics

Antenna design and orientation have a marked effect

upon radio wave propagation. For a single-wire antenna, strongest signals are transmitted along the perpendicular to the wire, and virtually no signal in the direction of the wire. For a vertical antenna, the signal strength is the same in all horizontal directions. Unless the polarization undergoes a change during transit, the strongest signal received from a vertical transmitting antenna occurs when the receiving antenna is also vertical.

For lower frequencies the radiation of a radio signal takes place by interaction between the antenna and the ground. For a vertical antenna, efficiency increases with greater length of the antenna. For a horizontal antenna, efficiency increases with greater distance between antenna and ground. Near-maximum efficiency is attained when this distance is one-half the wavelength. This is the reason for elevating low frequency antennas to great heights. However, at the lowest frequencies, the required height becomes prohibitively great. At 10 kHz it would be about 8 nautical miles for a half-wavelength antenna. Therefore, lower frequency antennas of practical length are inherently inefficient. This is partly offset by the greater range of a low frequency signal of the same transmitted power as one of higher frequency.

At higher frequencies, the ground is not used, both conducting portions being included in a dipole antenna. Not only can such an antenna be made efficient, but it can also be made sharply directive, thus greatly increasing the strength of the signal transmitted in a desired direction.

The power received is inversely proportional to the square of the distance from the transmitter, as described previously, assuming there is no attenuation due to absorption or scattering.

2112. Range

The range at which a usable signal is received depends upon the power transmitted, the sensitivity of the receiver, frequency, route of travel, noise level, and perhaps other factors. For the same transmitted power, both the groundwave and skywave ranges are greatest at the lowest frequencies, but this is somewhat offset by the lesser efficiency of antennas for these frequencies. At higher frequencies, only direct waves are useful, and the effective range is greatly reduced. Attenuation, skip distance, ground reflection, wave interference, condition of the ionosphere, atmospheric noise level, and antenna design all affect the range at which useful signals can be received.

2113. Radio Wave Spectra

Frequency is an important consideration in radio wave propagation. The following summary indicates the principal effects associated with the various frequency bands, starting with the lowest and progressing to the highest usable radio frequency.

Very Low Frequency (VLF, 10 to 30 kHz): The VLF

signals propagate between the bounds of the ionosphere and the Earth and are thus guided around the curvature of the Earth to great distances with low attenuation and excellent stability. Diffraction is maximum. Because of the long wavelength, large antennas are needed, and even these are inefficient, permitting radiation of relatively small amounts of power. Magnetic storms have little effect upon transmission because of the efficiency of the "Earth-ionosphere waveguide." During such storms, VLF signals may constitute the only source of radio communication over great distances. However, interference from atmospheric noise may be troublesome. Signals may be received from below the surface of the sea.

Low Frequency (LF, 30 to 300 kHz): As frequency is increased to the LF band and diffraction decreases, there is greater attenuation with distance, and range for a given power output falls off rapidly. However, this is partly offset by more efficient transmitting antennas. LF signals are most stable within groundwave distance of the transmitter. A wider bandwidth permits pulsed signals at 100 kHz. This allows separation of the stable groundwave pulse from the variable skywave pulse up to 1,500 km, and up to 2,000 km for over-water paths. The frequency for Loran C, which is being replaced by enhanced Loran, or eLoran, is in the LF band. This band is also useful for radio direction finding and time dissemination.

Medium Frequency (MF, 300 to 3,000 kHz): Ground waves provide dependable service, but the range for a given power is reduced greatly. This range varies from about 400 miles at the lower portion of the band to about 15 miles at the upper end for a transmitted signal of 1 kilowatt. These values are influenced, however, by the power of the transmitter, the directivity and efficiency of the antenna, and the nature of the terrain over which signals travel. Elevating the antenna to obtain direct waves may improve the transmission. At the lower frequencies of the band, skywaves are available both day and night. As the frequency is increased, ionospheric absorption increases to a maximum at about 1,400 kHz. At higher frequencies the absorption decreases, permitting increased use of sky waves. Since the ionosphere changes with the hour, season, and sunspot cycle, the reliability of skywave signals is variable. By careful selection of frequency, ranges of as much as 8,000 miles with 1 kilowatt of transmitted power are possible, using multihop signals. However, the frequency selection is critical. If it is too high, the signals penetrate the ionosphere and are lost in space. If it is too low, signals are too weak. In general, skywave reception is equally good by day or night, but lower frequencies are needed at night. The standard broadcast band for commercial stations (535 to 1,605 kHz) is in the MF band.

High Frequency (HF, 3 to 30 MHz): As in the higher band, the groundwave range of HF signals is limited to a few miles, but the elevation of the antenna may increase the direct-wave distance of transmission. Also, the height of the antenna does have an important effect upon skywave

transmission because the antenna has an “image” within the conducting Earth. The distance between antenna and image is related to the height of the antenna, and this distance is as critical as the distance between elements of an antenna system. Maximum usable frequencies fall generally within the HF band. By day this may be 10 to 30 MHz, but during the night it may drop to 8 to 10 MHz. The HF band is widely used for ship-to-ship and ship-to-shore communication.

Very High Frequency (VHF, 30 to 300 MHz): Communication is limited primarily to the direct wave, or the direct wave plus a ground-reflected wave. Elevating the antenna to increase the distance at which direct waves can be used results in increased distance of reception, even though some wave interference between direct and ground-reflected waves is present. Diffraction is much less than with lower frequencies, but it is most evident when signals cross sharp mountain peaks or ridges. Under suitable conditions, reflections from the ionosphere are sufficiently strong to be useful, but generally they are unavailable. There is relatively little interference from atmospheric noise in this band. Reasonably efficient directional antennas are possible with VHF. The VHF band used for most communication.

Ultra High Frequency (UHF, 300 to 3,000 MHz): Skywaves are not used in the UHF band because the ionosphere is not sufficiently dense to reflect the waves, which pass through it into space. Ground waves and ground-reflected waves are used, although there is some wave interference. Diffraction is negligible, but the radio horizon extends about 15 percent beyond the visible horizon, due principally to refraction. Reception of UHF signals is virtually free from fading and interference by atmospheric noise. Sharply directive antennas can be produced for transmission in this band, which is widely used for ship-to-ship and ship-to-shore communication.

Super High Frequency (SHF, 3,000 to 30,000 MHz): In the SHF band, also known as the microwave or as the centimeter wave band, there are no sky waves, transmission being entirely by direct and ground-reflected waves. Diffraction and interference by atmospheric noise are virtually nonexistent. Highly efficient, sharply directive antennas can be produced. Thus, transmission in this band is similar to that of UHF, but with the effects of shorter waves being greater. Reflection by clouds, water droplets, dust particles, etc., increases, causing greater scattering, increased wave interference, and fading. The SHF band is used for marine navigational radar.

Extremely High Frequency (EHF, 30,000 to 300,000 MHz): The effects of shorter waves are more pronounced in the EHF band, transmission being free from wave interference, diffraction, fading, and interference by atmospheric noise. Only direct and ground-reflected waves are available. Scattering and absorption in the atmosphere are pronounced and may produce an upper limit to the frequency useful in radio communication.

2114. Regulation of Frequency Use

While the characteristics of various frequencies are important to the selection of the most suitable one for any given purpose, these are not the only considerations. Confusion and extensive interference would result if every user had complete freedom of selection. Some form of regulation is needed. The allocation of various frequency bands to particular uses is a matter of international agreement. Within the United States, the Federal Communications Commission (FCC) has responsibility for authorizing civil use of particular frequencies. However, military and government use is reconciled with the FCC by the National Telecommunication and Information Administration (NTIA) of the Department of Commerce. In some cases a given frequency is allocated to several widely separated transmitters, but only under conditions which minimize interference, such as during daylight hours. Interference between stations is further reduced by the use of channels, each of a narrow band of frequencies. Assigned frequencies are separated by an arbitrary band of frequencies that are not authorized for use. In the case of radio aids to navigation and ship communications bands of several channels are allocated, permitting selection of band and channel by the user. The international allocation and sharing of radio frequencies is regulated by the International Telecommunication Union (ITU), in accordance with decisions made at World Radio Conferences, which are held every three to four years.

2115. Types of Radio Transmission

A series of waves transmitted at constant frequency and amplitude is called a **continuous wave**. This cannot be heard except at the very lowest radio frequencies, when it may produce, in a receiver, an audible hum of high pitch.

Although a continuous wave may be used directly, as in radiodirection finding, it is more commonly modified in some manner. This is called **modulation**. When this occurs, the continuous wave serves as a carrier wave for information. Any of several types of modulation may be used.

In **amplitude modulation (AM)** the amplitude of the carrier wave is altered in accordance with the amplitude of a modulating wave, usually of audio frequency, as shown in Figure 2115a. In the receiver the signal is demodulated by removing the modulating wave and converting it back to its original form. This form of modulation is widely used in voice radio, as in the standard broadcast band of commercial broadcasting.

If the frequency instead of the amplitude is altered in accordance with the amplitude of the impressed signal, as shown in Figure 2115a, **frequency modulation (FM)** occurs. This is used for commercial FM radio broadcasts and the sound portion of television broadcasts.

Pulse modulation (PM) is somewhat different, there being no impressed modulating wave. In this form of trans-

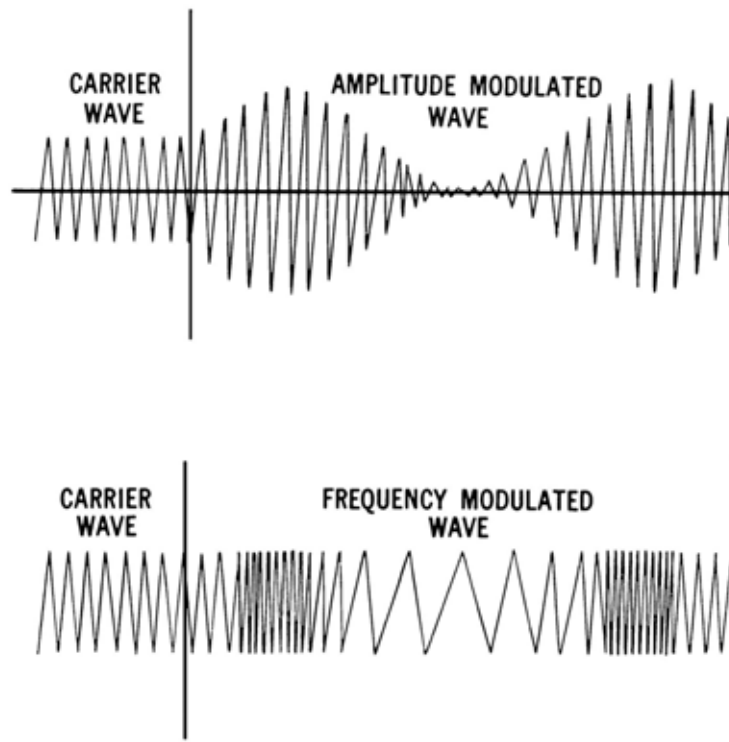

Figure 2115a. Amplitude modulation (upper figure) and frequency modulation (lower figure) by the same modulating wave.



Figure 2115b. Pulse modulation.

mission, very short bursts of carrier wave are transmitted, separated by relatively long periods of “silence,” during which there is no transmission. This type of transmission, illustrated in Figure 2115b, is used in some common radio navigational aids, including radar, and eLORAN.

2116. Transmitters

A radio **transmitter** consists essentially of (1) a power supply to furnish direct current, (2) an oscillator to convert direct current into radio-frequency oscillations (the carrier wave), (3) a device to control the generated signal, and (4) an amplifier to increase the output of the oscillator. For some transmitters a microphone is used with a modulator and final amplifier to modulate the carrier wave. In addition, an antenna and ground (for lower frequencies) are needed to produce electromagnetic radiation. These components are illustrated in Figure 2116.

2117. Receivers

When a radio wave passes a conductor, a current is

induced in that conductor. A radio receiver is a device which senses the power thus generated in an antenna, and transforms it into usable form. It is able to select signals of a single frequency (actually a narrow band of frequencies) from among the many which may reach the receiving antenna. The receiver is able to demodulate the signal and provide adequate amplification. The output of a receiver may be presented audibly by earphones or loudspeaker; or visually video display, or as digital data processed by a computer and either displayed or used to command and control other systems. In any case, the useful reception of radio signals requires three components: (1) an antenna, (2) a receiver, and (3) a display or data processing unit.

Radio receivers differ mainly in (1) frequency range, the range of frequencies to which they can be tuned; (2) selectivity, the ability to confine reception to signals of the desired frequency and avoid others of nearly the same frequency; (3) sensitivity, the ability to amplify a weak signal to usable strength against a background of noise; (4) stability, the ability to resist drift from conditions or values to which set; and (5) fidelity, the completeness with which the essential characteristics of the original signal are

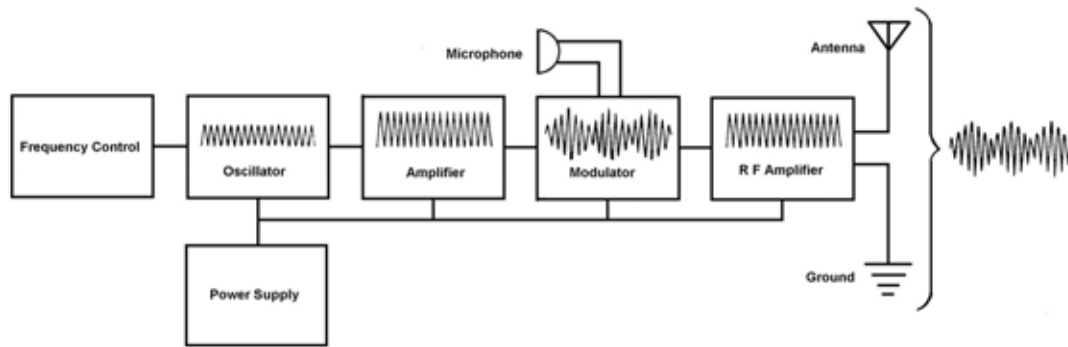

Figure 2116. Components of a radio transmitter.

reproduced. Receivers may have additional features such as an automatic frequency control, automatic noise limiter, etc.

Some of these characteristics are interrelated. For instance, if a receiver lacks selectivity, signals of a frequency differing slightly from those to which the receiver is tuned may be received. This condition is called spillover, and the resulting interference is called crosstalk.

If the selectivity is increased sufficiently to prevent spillover, it may not permit receipt of a great enough band of frequencies to obtain the full range of those of the desired signal. Thus, the fidelity may be reduced.

A **transponder** is a transmitter-receiver capable of accepting the challenge of being interrogated and automatically transmitting an appropriate reply.

U.S. RADIO NAVIGATION POLICY

2118. The Federal Radionavigation Plan

The ideal navigation system should provide three things to the user. First, it should be as accurate as necessary for the job it is expected to do. Second, it should be available 100 percent of the time, in all weather, at any time of day or night. Third, it should have 100 percent integrity, warning the user and shutting itself down when not operating properly. The mix of navigation systems in the U.S. is carefully chosen to provide maximum accuracy, availability, and integrity to all users, marine, aeronautical, and terrestrial, within the constraints of budget and practicality.



Figure 2118. Link to Federal Radionavigation Plan (2014): http://ntl.bts.gov/lib/55000/55100/55108/20150526_Final_Signed_2014_FRP.pdf

The **Federal Radionavigation Plan** (FRP) is produced by the U.S. Departments of Defense and Transportation. It establishes government policy on the mix of electronic navigation systems, ensuring consideration of national interests and efficient use of resources. It presents an integrated fed-

eral plan for all common-use civilian and military radionavigation systems, outlines approaches for consolidation of systems, provides information and schedules, defines and clarifies new or unresolved issues, and provides a focal point for user input. The FRP is a review of existing and planned radionavigation systems used in air, space, land, and marine navigation. It is available from the National Technical Information Service, Springfield, Virginia. The complete 2014 FRP is available via the link provided in Figure 2118.

The first edition of the FRP was released in 1980 as part of a presidential report to Congress. It marked the first time that a joint Department of Transportation (DOT)/Department of Defense (DOD) plan for position, navigation and timing (PNT) had been developed for used by both departments. With the transfer of the United States Coast Guard (USCG) from the DOT to the Department of Homeland Security (DHS), DHS was added as a signatory to the FRP. The FRP was designed to address coordinated planning of federally provided radionavigation systems. Since that time, the Federal planning process has evolved to include other elements of navigation and timing, now referred to as PNT. The FRP has had international impact on navigation systems; PNT services and systems are provided in a manner consistent with the standards and guidelines of international groups including the North Atlantic Treaty Organization (NATO) and other allies, the International Maritime Organization (IMO), the International Civil Aviation Organization (ICAO), the International Association

of Marine Aids to Navigation and Lighthouse Authorities (IALA), and other international organizations.

During a national emergency, any or all of the systems may be temporarily discontinued by the federal government. The government's policy is to continue to operate radionavigation systems as long as the U.S. and its allies derive greater benefit than adversaries. Operating agencies may shut down systems or change signal formats and characteristics during such an emergency.

The plan is reviewed continually and updated biennially. Industry, advisory groups, and other interested parties provide input. The plan considers governmental responsibilities for national security, public safety, and transportation system economy. It is the official source of radionavigation systems policy and planning for the United States. Systems covered by the FRP include the Global Positioning System (GPS), differential GPS DGPS, Wide area augmentation system (WAAS), Local area augmentation system (LAAS), Loran C or eLORAN, TACAN, Microwave Landing System (MLS), VHF Omnidirectional Range/ Distance Measurement Equipment (VOR/VOR-DME/VORTAC), and Instrument Landing System (ILS).

2119. System Plans

In order to meet both civilian and military needs, the federal government has established a number of different navigation systems. Each system utilizes the latest technology available at the time of implementation and is upgraded as technology and resources permit. The FRP addresses the length of time each system should be part of the system mix. The 2014 FRP sets forth the following system policy guidelines:

RADIOBEACONS: All U.S. marine radiobeacons have been discontinued and most of the stations converted into DGPS sites.

LORAN C: Provides navigation, location, and timing services for both civil and military air, land, and maritime users. LORAN C was replaced in the United States, by GPS, but due to its importance as an alternative to GPS, it is expected to be reactivated as *enhanced* LORAN, or eLORAN.

GPS: The Global Positioning System is the nation's, and the world's, primary radionavigation system. It is operated by the U.S. Air Force.

2120. Enhancements to GPS

Differential GPS (DGPS): DGPS is a ground based system in which differences between observed and calculated GPS signals are broadcast by radiobeacons to users using medium frequencies. The USCG, in cooperation with the U.S. Army Corp of Engineers, operates the maritime DGPS system in U.S. coastal waters

including Hawaii, parts of Alaska, portions of the Western Rivers, and the Great Lakes. It provides 10 meter continuous accuracy and integrity alarms, with a typical observed position error of 1-3 meters in a coverage area. In 2016, the inland portion of the National DGPS system, previously funded by the Department of Transportation, was decommissioned and ceased broadcasting.

Wide Area Augmentation System (WAAS): WAAS is a service of the Federal Aviation Administration (FAA), similar to DGPS, and is intended for cross-country and local air navigation, using a series of reference stations and broadcasting correction data through geostationary satellites. WAAS is not optimized for marine use, and while not certified for maritime navigation, may provide additional position accuracy if the signal is unobstructed. Accuracies of a few meters are possible, about the same as with DGPS.

Local Area Augmentation System (LAAS): LAAS is a precision positioning system provided by the FAA for local navigation in the immediate vicinity of airports so equipped. The correctional signals are broadcast on HF radio with a range of about 30 miles. LAAS is not intended or configured for marine use, but can provide extremely accurate position data in a local area.

2121. Factors Affecting Navigation System Mix

The navigator relies on simple, traditional gear, and on some of the most complex and expensive space-based electronic systems man has ever developed. The success of GPS as a robust, accurate, available, and flexible system has made older systems obsolete. Some of the systems which have already met their demise are Transit, Omega, and marine radiobeacons in the U.S. Some might say that the days are numbered for others systems too, as GPS currently retains its primacy in navigation technology.

In the U.S., the DOD, DHS, and DOT continually evaluate the components which make up the federally provided and maintained radionavigation system. Several factors influence the decision on the proper mix of systems; cost, military utility, accuracy requirements, and user requirements all drive the problem of allocating scarce resources to develop and maintain navigation systems.

Many factors influence the choice of PNT systems, which must satisfy an extremely diverse group of users. International agreements must be honored. The current investment in existing systems by both government and users must be considered. The full life-cycle cost of each system must be considered. No system will be phased out without consideration of these factors. The FRP recognizes that GPS may not meet the needs of all users; therefore, some systems are currently being evaluated independently of GPS. The goal is to meet all military and civilian requirements in the most efficient way possible.

RADIO DIRECTION FINDING

2122. Introduction

The simplest use of radio waves in navigation is radio direction finding, in which a MF radio signal is broadcast from a station at a known location. This signal is omnidirectional, but a directional antenna on a vessel is used to determine the bearing of the station. This constitutes a **Line of Position** (LOP), which can be crossed with another LOP to determine a fix.

Once used extensively throughout the world, radiobeacons have been discontinued in the U.S. and many other areas. They are now chiefly used as homing devices by local fishermen, and very little of the ocean's surface is covered by any radiobeacon signal. Because of its limited range, limited availability, and inherent errors, radio direction finding is of limited usefulness to the professional navigator.

In the past, when radiobeacon stations were powerful and common enough for routine ocean navigation, correction of radio bearings was necessary to obtain the most accurate LOP's. The correction process accounted for the fact that, while radio bearings travel along great circles, they are most often plotted on Mercator charts (Aviation charts use the Lambert proportional projection, for which straight lines represent great circles). The relatively short range of those stations remaining has made this process obsolete. Once comprising a major part of *NGA Pub. 117, Radio Navigational Aids*, radiobeacons are now listed in the back of each volume of the geographically appropriate *List of Lights*.

A radio direction finding station is one which the mariner can contact via radio and request a bearing. Most of these stations are for emergency use only, and a fee may be involved. These stations and procedures for use are listed in *NGA Pub. 117, Radio Navigational Aids*.

2123. Using Radio Direction Finders

Depending upon the design of the **radio direction finder (RDF)**, the bearings of the radio transmissions are measured as relative bearings, or as both relative and true bearings. The most common type of marine radiobeacon transmits radio waves of approximately uniform strength in all directions. Except during calibration, radiobeacons operate continuously, regardless of weather conditions. Simple combinations of dots and dashes comprising Morse code letters are used for station identification. All radiobeacons superimpose the characteristic on a carrier wave, which is broadcast continuously during the period of transmission. A 10-second dash is incorporated in the characteristic signal to enable users of the aural null type of radio direction finder to

refine the bearing.

Bearing measurement is accomplished with a directional antenna. Nearly all types of receiving antennas have some directional properties, but the RDF antenna is designed to be as directional as possible. Simple small craft RDF units usually have a ferrite rod antenna mounted directly on a receiver, with a 360 degree graduated scale. To get a bearing, align the unit to the vessel's course or to true north, and rotate the antenna back and forth to find the exact null point. The bearing to the station, relative or true according to the alignment, will be indicated on the dial. Some small craft RDF's have a portable hand-held combination ferrite rod and compass, with ear-phones to hear the null.

Two types of loop antenna are used in larger radio direction finders. In one of these, the crossed loop type, two loops are rigidly mounted in such manner that one is placed at 90 degrees to the other. The relative output of the two antennas is related to the orientation of each with respect to the direction of travel of the radio wave, and is measured by a device called a **goniometer**.

2124. Errors of Radio Direction Finders

RDF bearings are subject to certain errors. Quadrantal error occurs when radio waves arrive at a receiver and are influenced by the immediate shipboard environment.

A radio wave crossing a coastline at an oblique angle experiences a change of direction due to differences in conducting and reflecting properties of land and water known as coastal refraction, sometimes called land effect. It is avoided by not using, or regarding as of doubtful accuracy, bearings which cross a shoreline at an oblique angle.

In general, good radio bearings should not be in error by more than two or three degrees for distances under 150 nautical miles. However, conditions vary considerably, and skill is an important factor. By observing the technical instructions for the equipment and practicing frequently when results can be checked, one can develop skill and learn to what extent radio bearings can be relied upon under various conditions. Other factors affecting accuracy include range, the condition of the equipment, and the accuracy of calibration.

The strength of the signal determines the usable range of a radiobeacon. The actual useful range may vary considerably from the published range with different types of RDFs and during varying atmospheric conditions. The sensitivity of a RDF determines the degree to which the full range of a radiobeacon can be utilized. Selectivity varies with the type of receiver and its condition.

CHAPTER 22

SATELLITE NAVIGATION

INTRODUCTION

2200. Development

The idea that led to development of the satellite navigation systems dates back to 1957 and the first launch of an artificial satellite into orbit, Russia's Sputnik I. Dr. William H. Guier and Dr. George C. Wiffenbach at the Applied Physics Laboratory of the Johns Hopkins University were monitoring the famous "beeps" transmitted by the passing satellite. They plotted the received signals at precise intervals, and noticed that a characteristic Doppler curve emerged. Since satellites generally follow fixed orbits, they reasoned that this curve could be used to describe the satellite's orbit. They then demonstrated that they could determine all of the orbital parameters for a passing satellite by Doppler observation of a single pass from a single fixed station. The Doppler shift apparent while receiving a transmission from a passing satellite proved to be an effective measuring device for establishing the satellite orbit.

Dr. Frank T. McClure, also of the Applied Physics Laboratory, reasoned in reverse: If the satellite orbit was known, Doppler shift measurements could be used to

determine one's position on Earth. His studies in support of this hypothesis earned him the first National Aeronautics and Space Administration award for important contributions to space development.

In 1958, the Applied Physics Laboratory proposed exploring the possibility of an operational satellite Doppler navigation system. The Chief of Naval Operations then set forth requirements for such a system. The first successful launching of a prototype system satellite in April 1960 demonstrated the Doppler system's operational feasibility.

The **Navy Navigation Satellite System (NAVSAT)**, also known as **TRANSIT** was the first operational satellite navigation system. The system's accuracy was better than 0.1 nautical mile anywhere in the world, though its availability was somewhat limited. It was used primarily for the navigation of surface ships and submarines, but it also had some applications in air navigation. It was also used in hydrographic surveying and geodetic position determination.

The transit launch program ended in 1988 and the system was disestablished when the Global Positioning System became operational in 1996.

THE GLOBAL POSITIONING SYSTEM

2201. System Description

The Federal Radionavigation Plan has designated the **Navigation System using Timing And Ranging (NAVSTAR) Global Positioning System (GPS)** as the primary navigation system of the U.S. government. GPS

is a space-based radio positioning system which provides suitably equipped users with highly accurate position, velocity, and time data. It consists of three major segments: a **space segment**, a **control segment**, and a **user segment**.

Code/Frequency	L1 (1575.42 MHz)	L2 (1227.60 MHz)	L5 (1176.45 MHz)
C/A	X		
L1C	X		
P(y)	X	X	
M-Code	X	X	
L2 CM		X	
L2 CL		X	
L5 I			X
L5Q			X

Figure 2201. GPS Satellite Code by Broadcast Frequency.

The space segment consists of 31 GPS satellites with at least 24 operational 95% of the time. Spacing of the satellites in their orbits is arranged so that at least four satellites are in view to a user at any time, anywhere on the Earth, including the North and South Poles. Each satellite transmits signals on three radio frequencies, superimposed on which are navigation and system data. Included in this data are predicted satellite ephemeris, atmospheric propagation correction data, satellite clock error information and satellite health data. The satellites orbit at an altitude of 20,200 km, in six separate orbital planes, each plane inclined 55° relative to the equator. The satellites complete an orbit approximately once every 12 hours.

GPS satellites transmit **pseudorandom noise (PRN)** sequence-modulated radio frequencies, designated L1 (1575.42 MHz), L2 (1227.60 MHz) and L5 (1176.45 MHz). Various transmissions are sent on these channels as shown in Table 2201.

Superimposed on both the legacy C/A and P(y) codes is the navigation message. This message contains the satellite ephemeris data, atmospheric propagation correction data, and satellite clock bias. In addition, four additional new messages have been introduced by the so called GPS modernization: L2-CNAV, CNAV-2, L5-CNAV and MNAV. The “legacy” message and the first three of the modernized GPS are civil messages, while the MNAV is a military message. In modernized GPS, the same type of contents as the legacy navigation message (NAV) is transmitted but at a higher rate and with improved robustness.

The messages L2-CNAV, L5-CNAV and MNAV have a similar structure and (modernized) data format. The new format allows more flexibility, better control and improved content. Furthermore, the MNAV includes new improvements for the security and robustness of the military message. The CNAV-2 is modulated onto L1CD, sharing the same band as the “legacy” navigation message.

GPS assigns a unique C/A code and a unique P code to each satellite. This practice, known as **code division multiple access (CDMA)**, allows all satellites the use of a common carrier frequency while still allowing the receiver to determine which satellite is transmitting. CDMA also allows for easy user identification of each GPS satellite. Since each satellite broadcasts using its own unique C/A and P code combination, it can be assigned a unique **PRN sequence number**. This number is how a satellite is identified when the GPS control system communicates with users about a particular GPS satellite.

The control segment includes a **master control station (MCS)**, a number of monitor stations, and ground antennas located throughout the world. The master control station, located in Colorado Springs, Colorado, consists of equipment and facilities required for satellite monitoring, telemetry, tracking, commanding, control, uploading, and navigation message generation. The monitor stations, located in Hawaii, Colorado Springs, Kwajalein, Diego Garcia,

and Ascension Island, passively track the satellites, accumulating ranging data from the satellites’ signals and relaying them to the MCS. The MCS processes this information to determine satellite position and signal data accuracy, updates the navigation message of each satellite and relays this information to the ground antennas. The ground antennas then transmit this information to the satellites. The ground antennas, located at Ascension Island, Diego Garcia, and Kwajalein, are also used for transmitting and receiving satellite control information.

The user equipment is designed to receive and process signals from four or more orbiting satellites either simultaneously or sequentially. The processor in the receiver then converts these signals to navigation information. Since GPS is used in a wide variety of applications, from marine navigation to land surveying, these receivers can vary greatly in function and design.

2202. System Capabilities

GPS provides multiple users with accurate, continuous, worldwide, all-weather, common-grid, three-dimensional positioning and navigation information.

To obtain a navigation solution of position (latitude, longitude, and altitude) and time (four unknowns), four satellites must be used. The GPS user measures pseudorange and pseudorange rate by synchronizing and tracking the navigation signal from each of the four selected satellites. Pseudorange is the true distance between the satellite and the user plus an offset due to the user’s clock bias. Pseudorange rate is the true slant range rate plus an offset due to the frequency error of the user’s clock. By decoding the ephemeris data and system timing information on each satellite’s signal, the user’s receiver/processor can convert the pseudorange and pseudorange rate to three-dimensional position and velocity. Four measurements are necessary to solve for the three unknown components of position (or velocity) and the unknown user time (or frequency) bias.

The navigation accuracy that can be achieved by any user depends primarily on the variability of the errors in making pseudorange measurements, the instantaneous geometry of the satellites as seen from the user’s location on Earth, and the presence of **Selective Availability (SA)**. Selective Availability is discussed further below.

2203. Global Positioning System Concepts

GPS receivers (or user equipment) measure distances between satellites in orbit and a receiver on Earth, and computes spheres of position from those distances. The intersections of those spheres of position then determine the receiver’s position.

The distance measurements described above are done by comparing timing signals generated simultaneously by the satellites’ and receiver’s internal clocks. These signals, charac-

terized by a special wave form known as the pseudo-random code, are generated in phase with each other. The signal from the satellite arrives at the receiver following a time delay proportional to its distance traveled. This time delay is detected by the phase shift between the received pseudo-random code and the code generated by the receiver. Knowing the time required for the signal to reach the receiver from the satellite allows the receiver to calculate the distance from the satellite. The receiver, therefore, must be located on a sphere centered at the satellite with a radius equal to this distance measurement. The intersection of three spheres of position yields two possible points of receiver position. One of these points can be disregarded since it is hundreds of miles from the surface of the Earth. Theoretically, then, only three time measurements are required to obtain a fix from GPS.

In practice, however, a fourth measurement is required to obtain an accurate position from GPS. This is due to receiver clock error. Timing signals travel from the satellite to the receiver at the speed of light; even extremely slight timing errors between the clocks on the satellite and in the receiver will lead to tremendous range errors. The satellite's atomic clock is accurate to 10^{-9} seconds; installing a clock that accurate on a receiver would make the receiver prohibitively expensive. Therefore, receiver clock accuracy is sacrificed, and an additional satellite timing measurement is made. The fix error caused by the inaccuracies in the receiver clock is reduced by simultaneously subtracting a constant timing error from four satellite timing measurements until a pinpoint fix is reached.

Assuming that the satellite clocks are perfectly synchronized and the receiver clock's error is constant, the subtraction of that constant error from the resulting distance determinations will reduce the fix error until a "pinpoint" position is obtained. It is important to note here that the number of lines of position required to employ this technique is a function of the number of lines of position required to obtain a fix. GPS determines position in three dimensions; the presence of receiver clock error adds an additional unknown. Therefore, four timing measurements are required to solve for the resulting four unknowns.

2204. GPS Signal Coding

The GPS L1 band (1575.42 MHz) has turned out to be the most important band for navigation purposes. Indeed most of the applications in the world today are based on the signals transmitted at this frequency. Three signals are transmitted at the moment by GPS in L1: C/A Code, P(Y) Code and M-Code. In the future, an additional new civil signal, known as L1C, will also be transmitted.

GPS is transmitting in the L2 band (1227.60 MHz). It is modernized civil signal known as L2C together with the P(Y) Code and the M-Code. The P(Y) Code and M-Code were already described shortly in the previous chapter and the properties and parameters are thus similar to those in the L1 band. In addition, for Block IIR-M, IIF, and subsequent

blocks of SVs, two additional PRN ranging codes will be transmitted. They are the L2 Civil Moderate (L2 CM) code and the L2 Civil Long (L2 CL) code. These two signals are time multiplexed so that the resulting chipping rate is double as high as that of each individual signal.

The GPS L5 (1176.45 MHz) signal will be transmitted for the first time on board IIF satellites. The GPS carriers of the L5 band are modulated by two bit trains in phase quadrature: the L5 data channel and the L5 pilot channel. Moreover, two PRN ranging codes are transmitted on L5.

For a more detailed analysis of GPS signal coding see Appendix C in Volume I.

2205. The Correlation Process

The correlation process compares the signal received from the satellites with the signal generated by the receiver by comparing the square wave function of the received signal with the square wave function generated by the receiver. The computer logic of the receiver recognizes the square wave signals as either a +1 or a 0 depending on whether the signal is "on" or "off." The signals are processed and matched by using an **autocorrelation function**.

This process defines the necessity for a "pseudo-random code." The code must be repeatable (i.e., non-random) because it is in comparing the two signals that the receiver makes its distance calculations. At the same time, the code must be random for the correlation process to work; the randomness of the signals must be such that the matching process excludes all possible combinations except the combination that occurs when the generated signal is shifted a distance proportional to the received signal's time delay. These simultaneous requirements to be both repeatable (non-random) and random give rise to the description of "pseudo-random"; the signal has enough repeatability to enable the receiver to make the required measurement while simultaneously retaining enough randomness to ensure incorrect calculations are excluded.

2206. Precise Positioning Service and Standard Positioning Service

Two levels of navigational accuracy are provided by the GPS: the **Precise Positioning Service (PPS)** and the **Standard Positioning Service (SPS)**. GPS was designed, first and foremost, by the U.S. Department of Defense as a United States military asset; its extremely accurate positioning capability is an asset access to which the U.S. military may need to limit during time of war to prevent use by enemies. Therefore, the PPS is available only to authorized users, mainly the U.S. military and authorized allies. SPS, on the other hand, is available worldwide to anyone possessing a GPS receiver. The accuracy of the GPS signal in space is actually the same for both the civilian GPS service and the military GPS service.

However, SPS broadcasts on one frequency, while PPS uses two. This means military users can perform ionospheric correction, a technique that reduces radio degradation caused by the Earth's atmosphere. With less degradation, PPS provides better accuracy than the basic SPS.

The ongoing GPS modernization program is adding new civilian signals and frequencies to the GPS satellites, enabling ionospheric correction for all users. Eventually, the accuracy difference between military and civilian GPS will disappear. But military GPS will continue to provide important advantages in terms of enhanced security and jam resistance.

Anti-spoofing (A-S) is designed to negate any hostile imitation of GPS signals. The technique alters the P code into another code, designated the Y code. The C/A code remains unaffected. The U.S. employs this technique to the satellite signals at random times and without warning; therefore, civilian users are unaware when this P code transformation takes place. Since anti-spoofing is applied only to the P code, the C/A code is not protected and can be spoofed.

GPS PPS receivers can use either the P code or the C/A code, or both, in determining position. Maximum accuracy is obtained by using the P code on both L1 and L2. The difference in propagation delay is then used to calculate ionospheric corrections. The C/A code is normally used to acquire the satellite signal and determine the approximate P code phase. Some PPS receivers possess a clock accurate enough to track and lock on the P code signal without initially tracking the C/A code. Some PPS receivers can track only the C/A code and disregard the P code entirely. Since the C/A code is transmitted on only one frequency, the dual frequency ionosphere correction methodology is unavailable and an ionospheric modeling procedure is required to calculate the required corrections.

SPS receivers, as mentioned above, provide positions with a degraded accuracy. The A-S feature denies SPS users access to the P code when transformed to the Y code. Therefore, the SPS user cannot rely on access to the P code to measure propagation delays between L1 and L2 and compute ionospheric delay corrections. Consequently, the typical SPS receiver uses only the C/A code because it is unaffected by A-S. Like PPS, the C/A is transmitted only on L1, the dual frequency method of calculating ionospheric corrections is unavailable; an ionospheric modeling technique must be used. This is less accurate than the dual frequency method; this degradation in accuracy is accounted for in the 100-meter accuracy calculation.

2207. Selective Availability Discontinued

In May 2000, President Bill Clinton directed the Department of Defense to turn off the GPS **Selective Availability (SA)** feature. In 2007, the U.S. government announced plans to permanently eliminate SA by building

the GPS III satellites without it. SA was a method to degrade GPS accuracy to civilian users.

2208. GPS Receiver Operations

In order for the GPS receiver to navigate, it has to track satellite signals, make pseudorange measurements, and collect navigation data.

A typical satellite tracking sequence begins with the receiver determining which satellites are available for it to track. Satellite visibility is determined by user-entered predictions of position, velocity, and time, and by almanac information stored internal to the receiver. If no stored almanac information exists, then the receiver must attempt to locate and lock onto the signal from any satellite in view. When the receiver is locked onto a satellite, it can demodulate the navigation message and read the almanac information about all the other satellites in the constellation. A carrier tracking loop tracks the carrier frequency while a code tracking loop tracks the C/A and P code signals. The two tracking loops operate together in an iterative process to acquire and track satellite signals.

The receiver's carrier tracking loop will locally generate an L1 carrier frequency which differs from the satellite produced L1 frequency due to a Doppler shift in the received frequency. This Doppler offset is proportional to the relative velocity along the line of sight between the satellite and the receiver, subject to a receiver frequency bias. The carrier tracking loop adjusts the frequency of the receiver-generated frequency until it matches the incoming frequency. This determines the relative velocity between the satellite and the receiver. The GPS receiver uses this relative velocity to calculate the velocity of the receiver. This velocity is then used to aid the code tracking loop.

The code tracking loop is used to make pseudorange measurements between the GPS receiver and the satellites. The receiver's tracking loop will generate a replica of the targeted satellite's C/A code with estimated ranging delay. In order to match the received signal with the internally generated replica, two things must be done: 1) the center frequency of the replica must be adjusted to be the same as the center frequency of the received signal; and 2) the phase of the replica code must be lined up with the phase of the received code. The center frequency of the replica is set by using the Doppler-estimated output of the carrier tracking loop. The receiver will then slew the code loop generated C/A code through a millisecond search window to correlate with the received C/A code and obtain C/A tracking.

Once the carrier tracking loop and the code tracking loop have locked onto the received signal and the C/A code has been stripped from the carrier, the navigation message is demodulated and read. This gives the receiver other information crucial to a pseudorange measurement. The navigation message also gives the receiver the handover word, the code that allows a GPS receiver to shift from C/A code tracking to P code tracking.

The handover word is required due to the long phase (seven days) of the P code signal. The C/A code repeats every millisecond, allowing for a relatively small search window. The seven day repeat period of the P code requires that the receiver be given the approximate P code phase to narrow its search window to a manageable time. The handover word provides this P code phase information. The handover word is repeated every subframe in a 30 bit long block of data in the navigation message. It is repeated in the second 30 second data block of each subframe. For some receivers, this handover word is unnecessary; they can acquire the P code directly. This normally requires the receiver to have a clock whose accuracy approaches that of an atomic clock. Since this greatly increases the cost of the receiver, most receivers for non-military marine use do not have this capability.

Once the receiver has acquired the satellite signals from four GPS satellites, achieved carrier and code tracking, and has read the navigation message, the receiver is ready to begin making pseudorange measurements. Recall that these measurements are termed *pseudorange* because a receiver clock offset makes them inaccurate; that is, they do not represent the true range from the satellite, only a range biased by a receiver clock error. This clock bias introduces a fourth unknown into the system of equations for which the GPS receiver must solve (the other three being the x coordinate, y coordinate, and z coordinate of the receiver position). The receiver solves this clock bias problem by making a fourth pseudorange measurement, resulting in a fourth equation to allow solving for the fourth unknown. Once the four equations are solved, the receiver has an estimate of the receiver's position in three dimensions and of GPS time. The receiver then converts this position into coordinates referenced to an Earth model based on the World Geodetic System (1984).

2209. User Range Errors and Geometric Dilution of Precision

There are two formal position accuracy requirements for GPS:

- 1) The PPS spherical position accuracy shall be 16 meters SEP (spherical error probable) or better.
- 2) The SPS user two dimensional position accuracy shall be 100 meters 2 DRMS (distance root mean squared) or better.

Assume that a universal set of GPS pseudorange measurements results in a set of GPS position measurements. The accuracy of these measurements will conform to a normal (i.e. values symmetrically distributed around a mean of zero) probability function because the two most important factors affecting accuracy, the **geometric dilution of precision (GDOP)** and the **user equivalent range error (UERE)**, are continuously variable.

The UERE is the error in the measurement of the

pseudoranges from each satellite to the user. The UERE is the product of several factors, including the clock stability, the predictability of the satellite's orbit, errors in the 50 Hz navigation message, the precision of the receiver's correlation process, errors due to atmospheric distortion and the calculations to compensate for it, and the quality of the satellite's signal. The UERE, therefore, is a random error which is the function of errors in both the satellites and the user's receiver.

The GDOP depends on the geometry of the satellites in relation to the user's receiver. It is independent of the quality of the broadcast signals and the user's receiver. Generally speaking, the GDOP measures the "spread" of the satellites around the receiver. The optimum case would be to have one satellite directly overhead and the other three spaced 120° around the receiver on the horizon. The worst GDOP would occur if the satellites were spaced closely together or in a line overhead.

There are special types of DOP's (dilution of precision) for each of the position and time solution dimensions; these particular DOP's combine to determine the GDOP. For the vertical dimension, the **vertical dilution of precision (VDOP)** describes the effect of satellite geometry on altitude calculations. The **horizontal dilution of precision (HDOP)** describes satellite geometry's effect on position (latitude and longitude) errors. These two DOP's combine to determine the **position dilution of precision (PDOP)**. The PDOP combined with the **time dilution of precision (TDOP)** results in the GDOP. See Figure 2209.

2210. Ionospheric Delay Errors

Section 2209 covered errors in GPS positions due to errors inherent in the satellite signal (UERE) and the geometry of the satellite constellation (GDOP). Another major cause of accuracy degradation is the effect of the ionosphere on the radio frequency signals that comprise the GPS signal.

A discussion of a model of the Earth's atmosphere will be useful in understanding this concept. Consider the Earth as surrounded by three layers of atmosphere. The first layer, extending from the surface of the Earth to an altitude of approximately 10 km, is known as the **troposphere**. Above the troposphere and extending to an altitude of approximately 50 km is the **stratosphere**. Finally, above the stratosphere and extending to an altitude that varies as a function of the time of day is the **ionosphere**. Though radio signals are subjected to effects which degrade its accuracy in all three layers of this atmospheric model, the effects of the ionosphere are the most significant to GPS operation.

The ionosphere, as the name implies, is that region of the atmosphere which contains a large number of ionized molecules and a correspondingly high number of free electrons. These charged molecules have lost one or more electrons. No atom will lose an electron without an input of

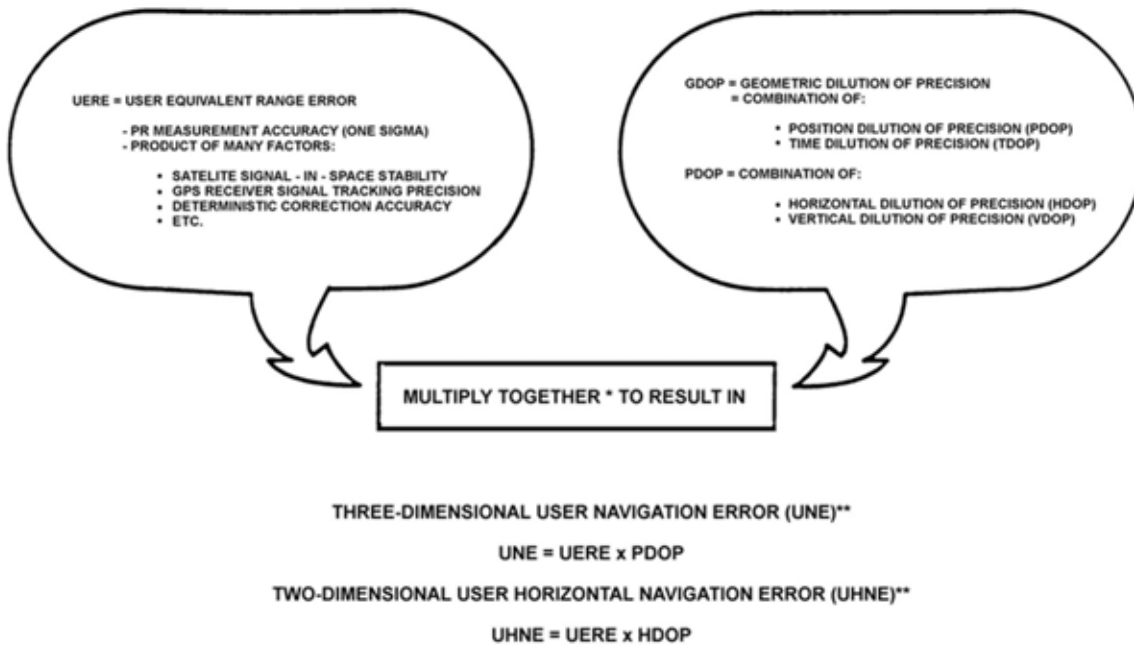

Figure 2209. Position and time error computations.

energy; the energy input that causes the ions to be formed in the ionosphere comes from the **ultraviolet (U-V)** radiation of the Sun. Therefore, the more intense the Sun's rays, the larger the number of free electrons which will exist in this region of the atmosphere.

The largest effect that this ionospheric effect has on GPS accuracy is a phenomenon known as **group time delay**. As the name implies, group time delay results in a delay in the time a signal takes to travel through a given distance. Obviously, since GPS relies on extremely accurate timing measurement of these signals between satellites and ground receivers, this group time delay can have a noticeable effect on the magnitude of GPS position error.

The group time delay is a function of several elements. It is inversely proportional to the square of the frequency at which the satellite transmits, and it is directly proportional to the atmosphere's **total electron content (TEC)**, a measure of the degree of the atmosphere's ionization. The general form of the equation describing the delay effect is:

$$\Delta t = \frac{(K \times TEC)}{f^2}$$

where

$$\begin{aligned} \Delta t &= \text{group time delay} \\ f &= \text{operating frequency} \\ K &= \text{constant} \end{aligned}$$

Since the Sun's U-V radiation ionizes the molecules in the upper atmosphere, it stands to reason that the time delay value will be highest when the Sun is shining and lowest at night. Experimental evidence has borne this out, showing that the value for TEC is highest around 1500 local time and lowest around 0500 local time. Therefore, the magnitude of

the accuracy degradation caused by this effect will be highest during daylight operations. In addition to these daily variations, the magnitude of this time delay error also varies with the seasons; it is highest at the vernal equinox. Finally, this effect shows a solar cycle dependence. The greater the number of sunspots, the higher the TEC value and the greater the group time delay effect. The solar cycle typically follows an eleven year pattern. The current solar cycle began on January 4, 2008 with minimal activity until early 2010. The cycle is on track to have the lowest recorded sunspot activity since cycle 14 which reached maximum in 1906. See Figure 2210 Solar cycle 24 prediction.

Given that this ionospheric delay introduces a serious accuracy degradation into the system, how does GPS account for it? There are two methods used: (1) the dual frequency technique, and (2) the ionospheric delay method.

2211. Dual Frequency Correction Technique

As the term implies, the dual frequency technique requires the ability to acquire and track both the L1 and L2 frequency signals. Recall from the discussion in Section 2204 that the C/A and P codes are transmitted on carrier frequency L1, but only the P code is transmitted on L2. Recall also that only authorized operators with access to DOD cryptographic material are able to copy the P code. It follows, then, that only those authorized users are able to copy the L2 carrier frequency. Therefore, only those authorized users are able to use the dual frequency correction method. The dual frequency method measures the distance between the satellite and the user based on both the L1 and L2 carrier signal. These ranges will be different because the group time delay for each signal will

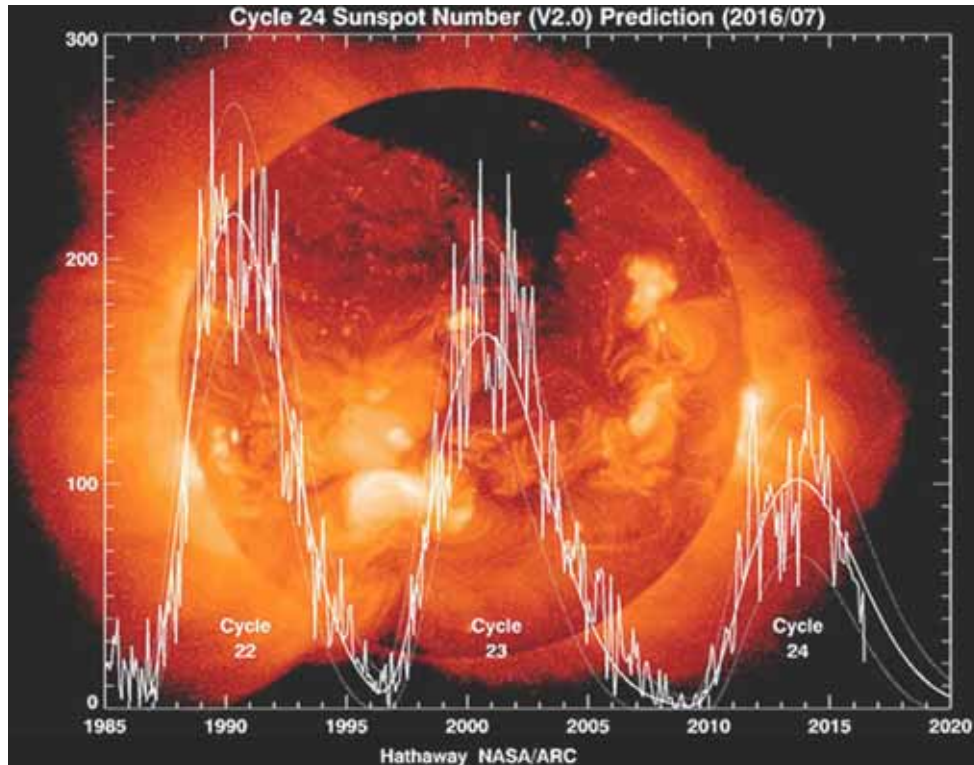

Figure 2210. Solar cycle prediction. Courtesy of NASA.

be different. This is because of the frequency dependence of the time delay error. The range from the satellite to the user will be the true range combined with the range error caused by the time delay, as shown by the following equation:

$$R(f) = R_{\text{actual}} + \text{error term}$$

where $R(f)$ is the range which differs from the actual range as a function of the carrier frequency. The dual frequency correction method takes two such range measurements, $R(L1)$ and $R(L2)$. Recall that the error term is a function of a constant divided by the square of the frequency. By combining the two range equations derived from the two frequency measurements, the constant term can be eliminated and one is left with an equation in which the true range is simply a function of the two carrier frequencies and the measured ranges $R(L1)$ and $R(L2)$. This method has two major advantages over the ionospheric model method: (1) it calculates corrections from real-time measured data, therefore, it is more accurate; (2) it alleviates the need to include ionospheric data on the navigation message. A significant portion of the data message is devoted to ionospheric correction data. If the receiver is dual frequency capable, then it does not need any of this data.

The vast majority of maritime users cannot copy dual frequency signals. For them, the ionospheric delay model

provides the correction for the group time delay.

2212. The Ionospheric Delay Model

The ionospheric delay model mathematically models the diurnal ionospheric variation. The value for this time delay is determined from a cosinusoidal function into which coefficients representing the maximum value of the time delay (i.e., the amplitude of the cosine wave representing the delay function), the time of day, the period of the variation and a minimum value of delay are introduced. This model is designed to be most accurate at the diurnal maximum. This is obviously a reasonable design consideration because it is at the time of day when the maximum diurnal time delay occurs that the largest magnitude of error appears. The coefficients for use in this delay model are transmitted to the receiver in the navigation data message. As stated in Section 2211, this method of correction is not as accurate as the dual frequency method; however, for the non-military user, it is the only method of correction available.

2213. Multipath Reflection Errors

Multipath reflection errors occur when the receiver detects parts of the same signal at two different times. The first reception is the direct path reception, the signal that is received directly from the satellite. The second reception is from a reflection of that same signal from the ground or any other reflective surface. The direct path signal arrives first,

the reflected signal, having had to travel a longer distance to the receiver, arrives later. The GPS signal is designed to minimize this multipath error. The L1 and L2 frequencies used demonstrate a diffuse reflection pattern, lowering the signal strength of any reflection that arrives at the receiver. In addition, the receiver's antenna can be designed to reject a signal that it recognizes as a reflection. In addition to the

properties of the carrier frequencies, the high data frequency of both the P and C/A codes and their resulting good correlation properties minimize the effect of multipath propagation.

The design features mentioned above combine to reduce the maximum error expected from multipath propagation to less than 20 feet.

DIFFERENTIAL GPS

2214. Differential GPS Concept

The discussions above make it clear that the Global Positioning System provides the most accurate positions available to navigators today. They should also make clear that the most accurate positioning information is available to only a small fraction of the using population: U.S. and allied military. For most open ocean navigation applications, the degraded accuracy inherent in selective availability and the inability to copy the precision code presents no serious hazard to navigation. A mariner seldom if ever needs greater than 100 meter accuracy in the middle of the ocean.

It is a different situation as the mariner approaches shore. Typically for harbor approaches and piloting, the mariner will shift to visual piloting. The increase in accuracy provided by this navigational method is required to ensure ship's safety. The 100 meter accuracy of GPS in this situation is not sufficient. Any mariner who has groped his way through a restricted channel in a thick fog will certainly appreciate the fact that even a degraded GPS position is available for them to plot. However, 100 meter accuracy is not sufficient to ensure ship's safety in most piloting situations. In this situation, the mariner needs P code accuracy. The problem then becomes how to obtain the accuracy of the Precise Positioning Service with due regard to the legitimate security concerns of the U.S. military. The answer to this seeming dilemma lies in the concept of **Differential GPS (DGPS)**.

Differential GPS is a system in which a receiver at an accurately surveyed position utilizes GPS signals to calculate timing errors and then broadcasts a correction signal to account for these errors. This is an extremely

powerful concept. The errors which contribute to GPS accuracy degradation, ionospheric time delay and selective availability, are experienced simultaneously by both the DGPS receiver and a relatively close user's receiver. The extremely high altitude of the GPS satellites means that, as long as the DGPS receiver is within 100-200 km of the user's receiver, the user's receiver is close enough to take advantage of any DGPS correction signal.

The theory behind a DGPS system is straightforward. Located on an accurately surveyed site, the DGPS receiver already knows its location. It receives data which tell it where the satellite is. Knowing the two locations, it then calculates the theoretical time it should take for a satellite's signal to reach it. It then compares the time that it actually takes for the signal to arrive. This difference in time between the theoretical and the actual is the basis for the DGPS receiver's computation of a timing error signal; this difference in time is caused by all the errors to which the GPS signal is subjected; errors, except for receiver error and multipath error, to which both the DGPS and the user's receivers are simultaneously subject. The DGPS system then broadcasts a timing correction signal, the effect of which is to correct for selective availability, ionospheric delay, and all the other error sources the two receivers share in common.

For suitably equipped users, DGPS results in positions at least as accurate as those obtainable by the Precise Positioning Service. This capability is not limited to simply displaying the correct position for the navigator to plot. The DGPS position can be used as the primary input to an electronic chart system, providing an electronic readout of position accurate enough to pilot safely in the most restricted channel.

SATELLITE BASED AUGMENTATION SYSTEMS (SBAS)

2215. WAAS/LAAS for Aeronautical Use

The **Wide Area Augmentation System (WAAS)** program, which corrects for GPS signal errors caused by ionospheric disturbances, timing, and satellite orbit errors, provides vital integrity information regarding the health of each GPS satellite. The concept is similar to the DGPS concept, except that correctional signals are sent from geostationary satellites via HF signals directly to the user's

GPS receiver. This eliminates the need for a separate receiver and antenna, as is the case with DGPS. WAAS is intended for en route air navigation, with 25 reference stations widely spaced across the United States that monitor GPS satellite data and two master stations on either coast, and creates a GPS correction message. WAAS provides coverage of the entire U.S. and parts of Mexico and Canada.

The **Local Area Augmentation System (LAAS)** is

intended for precision airport approaches, with reference stations located at airports and broadcasting their correction message on VHF radio frequencies.

While many marine GPS receivers incorporate WAAS circuitry (but not the more accurate, shorter-range LAAS), WAAS is not optimized for surface navigation because the HF radio signals are line-of-sight and are transmitted from geostationary satellites. At low angles to the horizon, the WAAS signal may be blocked and the resulting GPS position accuracy significantly degraded with no warning. The DGPS signal, on the other hand, is a terrain-following signal that is unaffected by objects in its path. It simply flows around them and continues on unblocked.

The accuracy of WAAS and DGPS is comparable, on the order of a few meters. Any GPS receiver equipped to receive WAAS has its accuracy improved to less than 3 meters. Both systems have been found in actual use to provide accuracies somewhat better than designed. DGPS was designed to provide 10 meter accuracy 95% of the time, but in actual use one can expect about 1-3 meter accuracy when the user is within 100 miles of the DGPS transmitter. Over 100 miles, DGPS accuracy will commonly degrade by an additional 1 meter per 100 miles from the transmitter site.

The WAAS signal, while not certified for use in the marine environment as is DGPS, can be a very useful navigational tool if its limitations are understood. In open waters of the continental U.S., the WAAS signal can be expected to be available and useful, provided the receiver has WAAS circuitry and is programmed to use the WAAS data. Outside the U.S., or in any area where tall buildings, trees, or other obstructions rise above the horizon, the WAAS signal may be blocked, and the resulting GPS fix could be in error by many meters. Since the highest accuracy is necessary in the most confined waters, WAAS should be used with extreme caution in these areas.

WAAS can enhance the navigator's situational awareness when available, but availability is not assured. Further, a marine receiver will provide no indication when WAAS data is not a part of the fix. [Aircraft GPS receivers may contain Receiver Autonomous Integrity Monitoring (RAIM) software, which provides warning of WAAS satellite signal failure, and removes the affected signal from the fix solution.]

NON-U.S. SATELLITE NAVIGATION SYSTEMS

2218. The Galileo System

Galileo is the **global navigation satellite system** (GNSS) that is currently being created by the European Union (EU) through the European Space Agency (ESA) and the European GNSS Agency (GSA), with two ground operations centers in Germany and Italy.

One of the aims of Galileo is to provide an indigenous alternative high-precision positioning system upon which

LAAS data, broadcast on VHF, is less subject to blocking, but is only available in selected areas near airports. Its range is about 30 miles. It is therefore not suitable for general marine navigational use.

2216. More Information

For more information on the Global Positioning System (GPS) and related topics see the link provided in Figure 2216.



Figure 2216. GPS.gov at <http://www.gps.gov>

2217. Foreign SBAS

SBAS systems are spreading out all over the world. More and more, it is believed that upon dual-frequency SBAS service provision, a seamless navigation will be possible from and to any two locations in the world.

Presently, three foreign SBAS systems are operational. These are Japan's Multi-functional Transport Satellite based Augmentation System (MSAS), the European Geostationary Navigation Overlay Service (EGNOS) and India's GPS and Geo-Augmented Navigation System (GAGAN),

Other foreign SBAS are under implementation such as SDCM (System of Differential Correction and Monitoring) in Russia and SNAS (Satellite Navigation Augmentation System) in China. Still others are under development or feasibility studies; SACCSA (Solucion de Aumentacion para Caribe, Centro y Sudamerica) would cover Central & South America including the Caribbean. Member States to SACCSA include Argentina Bolivia, Colombia, Costa Rica, Guatemala, Panama, Spain and Venezuela. Malaysia, much of Africa and South Korean SBAS are also studying SBAS particularly for aeronautical navigation.

European nations can rely, independently from other country systems, in case they were disabled by their operators.

The use of basic (low-precision) Galileo services will be free and open to everyone. The high-precision capabilities will be available for paying commercial users. Galileo is intended to provide horizontal and vertical position measurements within one meter precision, and better positioning services at high latitudes than other positioning systems.

Galileo is to provide a new global search and rescue (SAR) function as part of the Medium-altitude Earth Orbit Search and Rescue (MEOSAR) system. Satellites will be equipped with a transponder which will relay distress signals from emergency beacons to a rescue coordination center, which will then initiate a rescue operation. At the same time, the system is projected to provide a signal, the Return Link Message (RLM), to the emergency beacon, informing victims that their situation has been detected and help is on the way. This latter feature is new and is considered a major upgrade compared to the existing international search and rescue system (Cospas-Sarsat), which does not provide feedback to the user.

Galileo will also provide an important feature for civilian use that GPS does not: integrity monitoring. Currently, a civilian GPS user receives no indication that his unit is not receiving proper satellite signals, there being no provision for such notification in the code. However, Galileo will provide such a signal, alerting the user that the system is operating improperly.

The first Galileo test satellite, the GIOVE-A, was launched 28 December 2005, while the first satellite to be part of the operational system was launched on 21 October 2011. As of May 2016 the system has 14 of 30 satellites in orbit. Galileo will start offering Early Operational Capability (EOC) from 2016, go to Initial Operational Capability (IOC) in 2017-18 and reach Full Operational Capability (FOC) in 2019. The complete 30-satellite Galileo system (24 operational and 6 active spares) is expected by 2020.

For detailed information on the Galileo signal structure see Appendix C in Volume I.

2219. GLONASS

The **Global Navigation Satellite System (GLONASS)**, under the control of the Russian military, has been in use since 1993, and is based on the same principles as GPS. The space segment consists of 24 satellites in three orbital planes, the planes separated by 120 degrees and the individual satellites by 45 degrees. The orbits are inclined to the equator at an angle of 64.8 degrees, and the orbital period is about 11 hours, 15 minutes at an altitude of 19,100 km (10,313 nm). The designed system fix accuracy for civilian use is 100 meters horizontal (95%), 150 meters vertical, and 15 cm/sec. in velocity. Military codes provide accuracies of some 10-20 meters horizontal.

The ground segment of GLONASS lies entirely within the former Soviet Union. Reliability has been an ongoing problem for the GLONASS system, but new satellite designs with longer life spans are addressing these concerns. The user segment consists of various types of receivers that provide position, time, and velocity information.

GLONASS signals are in the L-band, operating in 25 channels with 0.5625 MHz separation in 2 bands: from 1602.5625 MHz to 1615.5 MHz, and from 1240 to 1260

MHz.

For detailed information on the GLONASS signal structure see Appendix C in Volume I.

2220. BeiDou

The **BeiDou Navigation Satellite System (BDS)**, also known as BeiDou-2, is China's second-generation satellite navigation system that will be capable of providing positioning, navigation, and timing services to users on a continuous worldwide basis.

Although the evolution of its regional navigation system towards a global solution started in 1997, the formal approval by the Government of the development and deployment of BDS System was done in 2006 and it is expected to provide global navigation services by 2020, similarly to the GPS, GLONASS or Galileo systems.

As of December 2011, the BeiDou system was officially announced to provide Initial Operational Service providing initial passive positioning navigation and timing services for the whole Asia-Pacific region with a constellation of 10 satellites (5 GEO satellites and 5 Inclined Geosynchronous Satellite Orbit (IGSO) satellites). During 2012, 5 additional satellites (1 GEO satellite and 4 Medium-Earth Orbit (MEO) satellites) were launched increasing to 14 the number of satellites of the constellation. In 2020, the system is going to launch the remaining satellites and evolve towards global navigation capability.

The BeiDou Space Segment consists of a constellation of 35 satellites, which include 5 geostationary earth orbit (GEO) satellites and 30 non-GSO satellites. The system is currently under development evolving from a regional system called BeiDou-1, and in the first phase will provide global navigation services by 2020, similarly to the GPS, GLONASS or Galileo systems.

For detailed information on the BeiDou signal plan see Appendix C in Volume I.

2221. IRNSS

The **Indian Regional Navigational Satellite System (IRNSS)** is a regional satellite navigation system owned by the Indian government. The system is being developed by Indian Space Research Organization (ISRO).

In April 2016, with the last launch of the constellation's satellite, IRNSS was renamed Navigation Indian Constellation (NAVIC) by India's Prime Minister Narendra Modi.

IRNSS will be an independent and autonomous regional navigation system aiming a service area of about 1500 kilometers around India. The system will be under complete Indian control, with the space segment, ground segment and user receivers all being built in India. It will have a range of applications including personal navigation.

For detailed information on the IRNSS signal plan see Appendix C in Volume I.

2222. QZSS

The **Quasi-Zenith Satellite System (QZSS)** is a regional navigation satellite system commissioned by the Japanese Government as a National Space Development Program.

QZSS was authorized by the Japanese government in 2002. At the beginning the system was developed by the Advanced Space Business Corporation (ASBC) team, including Mitsubishi Electric Corp., Hitachi Ltd., and GNSS Technologies Inc. When in 2007 ASBC collapsed, the work was taken over by JAXA together with Satellite Positioning Research and Application Center (SPAC), established in February 2007 and approved by the Ministers associated

with QZSS research and development.

The QZSS service area covers East Asia and Oceania region and its platform is multi-constellation GNSS. The QZSS system is not required to work in a stand-alone mode, but together with data from other GNSS satellites.

For detailed information on the QZSS signal plan see Appendix C in Volume I.

2223. References

Ávila Rodríguez, José Ángel. (2008). *On Generalized Signal Waveforms for Satellite Navigation*. University FAF, Munich. Retrieved from: <https://athene-forschung-unibw.de/doc/86167/86167.pdf>

CHAPTER 23

RADAR NAVIGATION

PRINCIPLES OF RADAR OPERATION

2300. Introduction

Radar determines distance to an object by measuring the time required for a radio signal (moving at the speed of light) to travel from a transmitting antenna to the object, reflect off that object, and return as a received echo.

Distance, or range, can be found by the simple formula:

$$\text{range} = 1/2 (C \times t)$$

where range is in nautical miles

C = the speed of light in nautical miles per second, and

t = the time in seconds from the time of pulse transmission to echo reception.

Because the value of C is very large (162,000 NM/sec), t is very small, 0.0001 sec for a target at a range of 10 miles for example.

Such measurements can be converted into lines of position (LOP's) comprised of circles with radius equal to the distance to the object. Since marine radars use directional antennae, they can also determine an object's bearing. However, due to its design, radar's bearing measurements are much less accurate than its distance measurements. Understanding this concept is crucial to ensuring the optimal employment of the radar for safe navigation.

2301. Signal Characteristics

In most marine navigation applications, the radar signal is pulse modulated. Signals are generated by a timing circuit so that energy leaves the antenna in very short pulses, usually less than one millionth of a second (or 1 μ sec) in duration. When transmitting, the antenna is connected to the transmitter but not the receiver. As soon as the pulse leaves, an electronic switch disconnects the antenna from the transmitter and connects it to the receiver. Another pulse is not transmitted until after the preceding one has had time to travel to the most distant target within range and return. Since the interval between pulses is long compared with the length of a pulse, strong signals can be provided with low average power. The duration or length of a single pulse is called **pulse length**, **pulse duration**, or **pulse width**. This pulse emission sequence repeats a great many times, perhaps 1,000 per second. This rate defines the **pulse repetition rate (PRR)**. The returned pulses are

displayed on an indicator screen or *display*.

2302. The Transmitter

In traditional marine radar sets, those produced since the 1940s, the transmitter is a special electronic oscillator diode tube known as a magnetron. The magnetron produces very high power microwaves (25 KW and greater) for very short periods of time.

Recently, another type of radar has been introduced into the commercial marine industry known as solid state or *coherent* radar. In modern solid state radars, the pulses generated by special circuitry in the transmitter are of much less power, much longer in length, and of varying frequency. This type of radar does not use a magnetron and generates an entirely different waveform. Presently, solid state radar is only available in the S-Band and will be further discussed in the following sections.

2303. The Receiver

The function of the receiver is to amplify the strength of the very weak return echoes. The enhanced signals can then be used to produce video signals which are presented as targets on the display. The amplifiers in a traditional magnetron radar have to deal with only one frequency, either 3000 MHz or 10000 MHz depending on the radar set.

A solid state radar receiver however, must process a much more complex signal with changing frequency. This variable frequency, or chirp, necessitates signal processing within the receiver known as pulse compression, which shortens the comparatively long, 5 - 18 microsecond transmitted pulse into a pulse of similar length to traditional radars (0.05 - 1.0 μ sec), while at the same time increasing signal amplitude, thus yielding the same detection and range measuring capabilities. A very great advantage of solid state radars over magnetron radars is their superior ability to filter out rain and sea clutter effects and therefore assist the radar observer in identification of land targets used in radar navigation.

2304. The Antenna

Nearly all modern commercial marine radars use a type of antenna known as a slotted waveguide. See Figure 2304 Slotted waveguide antenna. Both solid state and magnetron

radar sets utilize this antenna configuration because it is simple, efficient, and produces a beam that minimizes un-

wanted side lobes (side lobes will be discussed later in this chapter).

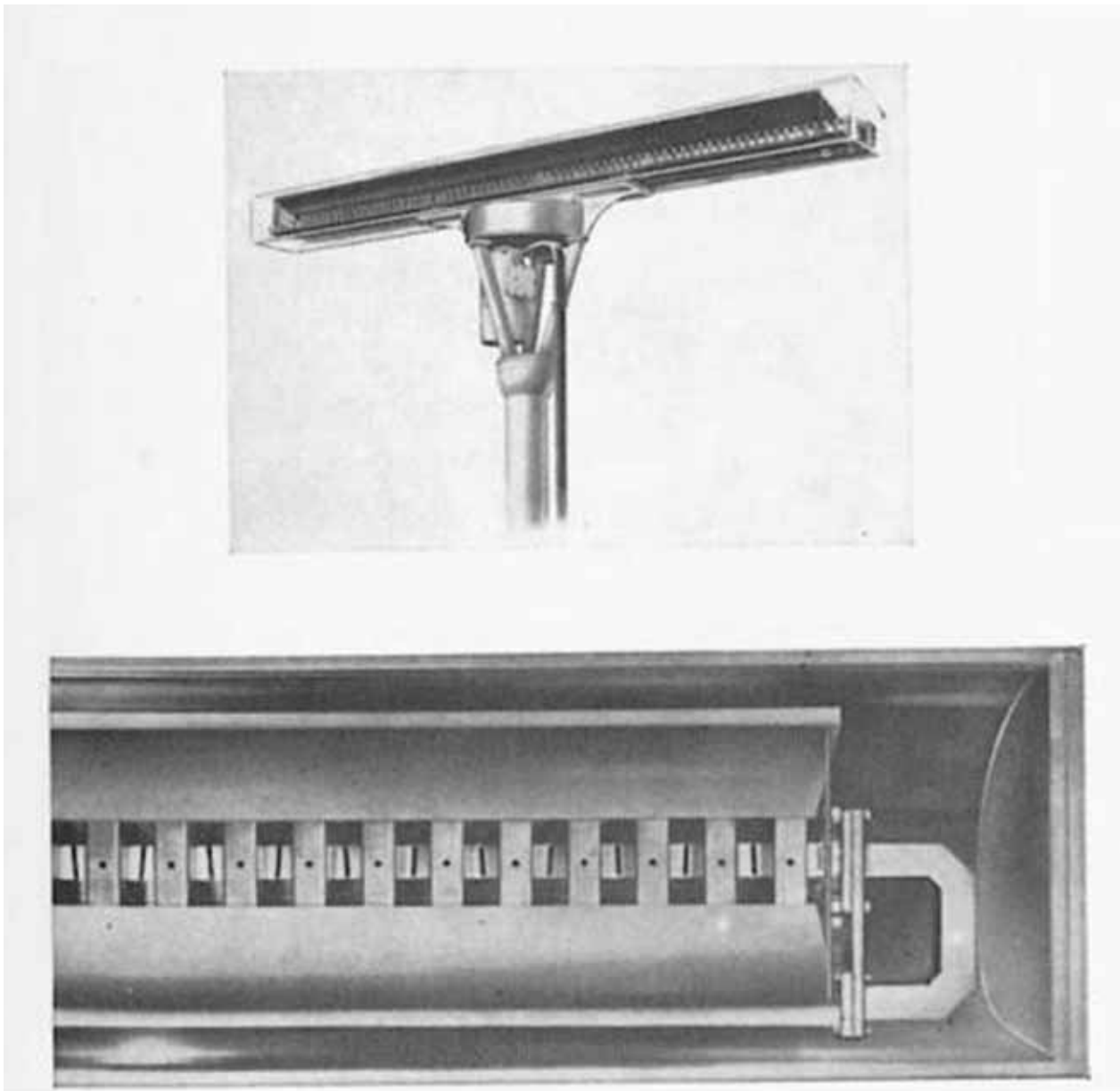

Figure 2304. Slotted waveguide antenna.

2305. The Display

The radar display is often referred to as the **plan position indicator (PPI)**. On a PPI, the sweep appears as a radial line, centered at the center of the scope and rotating in synchronization with the antenna. Any returned echo causes a brightening of the display screen at the bearing and range of the object. The glow continues after the sweep rotates past the target.

On a PPI, a target's actual range is proportional to its distance from the center of the scope. A movable cursor

helps to measure ranges and bearings. In the "heading-upward" presentation, which indicates relative bearings, the top of the scope represents the direction of the ship's head. In this destabilized presentation, the orientation changes as the ship changes heading. In the stabilized "north-upward" presentation, gyro north is always at the top of the scope.

2306. The Radar Beam

The pulses of energy comprising the radar beam would



Figure 2306a. Freespace radiation pattern.

form a single lobe-shaped pattern of radiation if emitted in free space. Figure 2306a shows this free space radiation pattern, including the undesirable minor lobes or side lobes associated with practical antenna design. This radiation pattern, as well as the effects of diffraction, reflection and attenuation described below, are common to both magnetron and solid state generated radar signals. Although the radiated energy is concentrated into a relatively narrow main beam by the antenna, there is no clearly defined envelope of the energy radiated, although most of the energy is concentrated along the axis of the beam.

The radiation diagram shown in Figure 2306b depicts

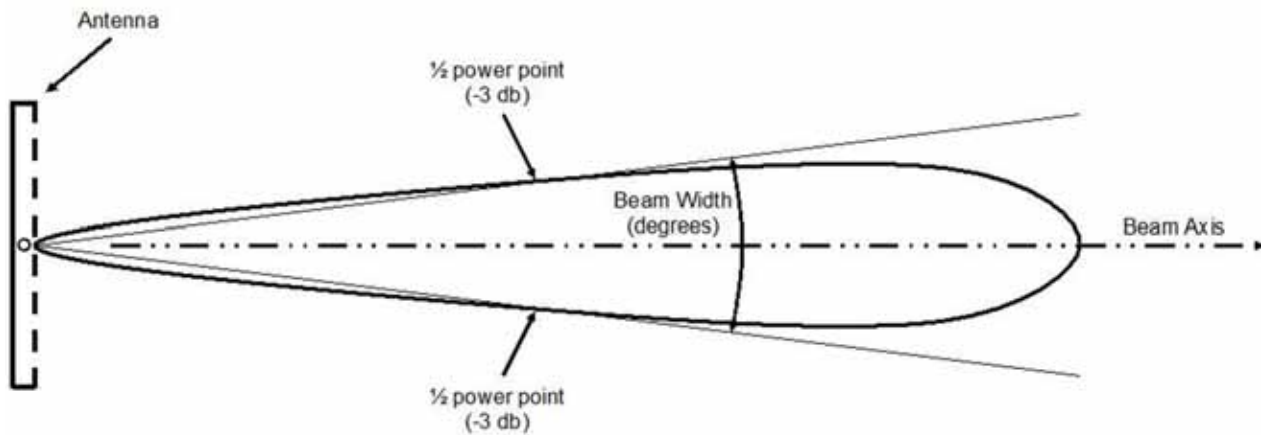

Figure 2306b. Radiation diagram.

relative values of power in the same plane existing at the same distances from the antenna or the origin of the radar beam. Maximum power is in the direction of the axis of the beam. Power values diminish rapidly in directions away from the axis. The beam width is taken as the angle between the half-power points.

The beam width depends upon the frequency or wavelength of the transmitted energy, antenna design, and the dimensions of the antenna. For a given antenna size (antenna aperture), narrower beam widths result from using shorter wavelengths. For a given wavelength, narrower beam widths result from using larger antennas, or i.e.,

beam width is inversely proportional to antenna aperture. Because marine radar antennas are long in the horizontal dimension and narrow in the vertical dimension, they produce a beam that is narrow in the horizontal direction and somewhat wider in the vertical direction. The narrow horizontal beam is desirable for bearing accuracy while the wide vertical beam is needed to account for the pitching and rolling of a vessel in a seaway. If the vertical beam was as narrow as the horizontal beam, a vessel in rough weather would experience intermittent target response as the beam would not intersect the horizon at all times.

The main lobe of the radar beam is composed of a

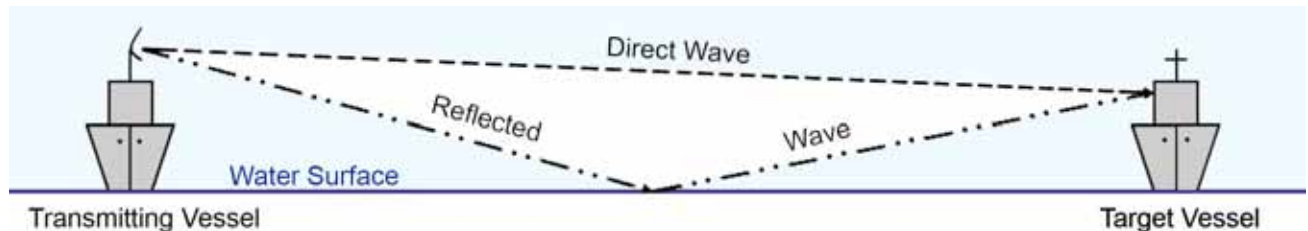

Figure 2306c. Direct and indirect waves.

number of separate lobes in the vertical dimension, as opposed to the single lobe-shaped pattern of radiation as

emitted in free space. This phenomenon is the result of interference between radar waves taking a direct line-of-

sight path to a target, and those waves that are reflected from the surface of the sea before striking the target. There is a slight difference in distance between which the direct and indirect waves must travel. See Figure 2306c. These reflected (indirect) waves interfere either constructively or destructively with the direct waves depending upon the waves' phase relationship. This sets up the possibility of poor target response for objects at certain ranges from own ship.

2307. Effects of Distance, Target Response, Attenuation and Diffraction

Just as a light source reflected in a mirror appears much dimmer than the direct image, radar echoes are much weaker than the transmitted pulses due to the general spreading out of the radar signal energy with distance. The strengths of these echoes are also dependent upon the amount of transmitted energy striking the targets and the size and reflecting properties of the targets known as *radar cross section*.

Attenuation is the scattering and absorption of the energy in the radar beam as it passes through the atmosphere. It causes a decrease in echo strength. Attenuation is greater in 3-cm rather than 10-cm radar. Atmospheric water particles (heavy fog, rain and snow) can significantly degrade the performance of a 3-cm radar system. During periods of heavy precipitation, the radar observer should switch to the 10-cm set if one is available.

Diffraction is the bending of a wave as it passes an obstruction. Because of diffraction there is some illumination of the region behind an obstruction or target by the radar beam. Diffraction effects are greater at the lower frequencies with longer wavelengths (S-Band). Thus, the radar beam of 10-cm radar tends to illuminate more of the shadow region behind an obstruction than the beam of X-Band radar of 3-cm wavelength.

2308. Refraction

If the radar waves traveled in straight lines, the distance to the radar horizon would be dependent only on the power output of the transmitter and the height of the antenna. In other words, the distance to the radar horizon would be the same as that of the geometrical horizon for the antenna height. However, atmospheric density gradients bend radar rays as they travel to and from a target. This bending is called **refraction**.

The distance to the radar horizon does not always limit the distance from which echoes may be received from targets. Assuming that adequate power is transmitted, echoes may be received from targets beyond the radar horizon if their reflecting surfaces extend above it. The distance to the radar horizon is the distance at which the radar rays pass tangent to the surface of the Earth.

The following formula, where h is the height of the an-

tenna in feet, gives the theoretical distance to the radar horizon in nautical miles:

$$D = 1.22\sqrt{h} .$$

D = the range in nautical miles

h = height of the antenna.

2309. Factors Affecting Radar Interpretation

Radar's value as a navigational aid depends on the navigator's understanding its characteristics and limitations. Whether measuring the range to a single reflective object or trying to discern a shoreline lost amid severe clutter, knowledge of the characteristics of the individual radar used are crucial. Some of the factors to be considered in interpretation are discussed below:

- **Resolution in Range.** In Part A of Figure 2309a, a transmitted pulse has arrived at the second of two targets of insufficient size or density to absorb or reflect all of the energy of the pulse. While the pulse has traveled from the first to the second target, the echo from the first has traveled an equal distance in the opposite direction. At B, the transmitted pulse has continued on beyond the second target, and the two echoes are returning toward the transmitter. The distance between leading edges of the two echoes is twice the distance between targets and so the display will indicate two distinct targets. The correct distance between targets will be shown on the display, which is calibrated to show half the distance traveled out and back. At C the targets are closer together and the pulse length has been increased. The two echoes merge, and on the scope they will appear as a single, large target. At D the pulse length has been decreased, and the two echoes appear separated. The ability of a radar to separate targets close together on the same bearing is called *resolution in range*. It is related primarily to pulse length. The minimum distance between targets that can be distinguished as separate is one half the pulse length. This (half the pulse length) is the apparent depth or thickness of a target but in no way represents that actual size of a small isolated target like a buoy or boat. Thus, several ships close together on nearly the same bearing may appear as an island. Echoes from a number of small boats, piles, breakers, or even a single large ship close to the shore may blend with echoes from the shore, resulting in an incorrect indication of the position and shape of the shoreline.
- **Resolution in Bearing.** Echoes from two or more targets close together at the same range may merge to form a single, wider echo. The ability to separate targets close together at the same range is called *resolution in bearing*. Bearing resolution is a function of two vari-

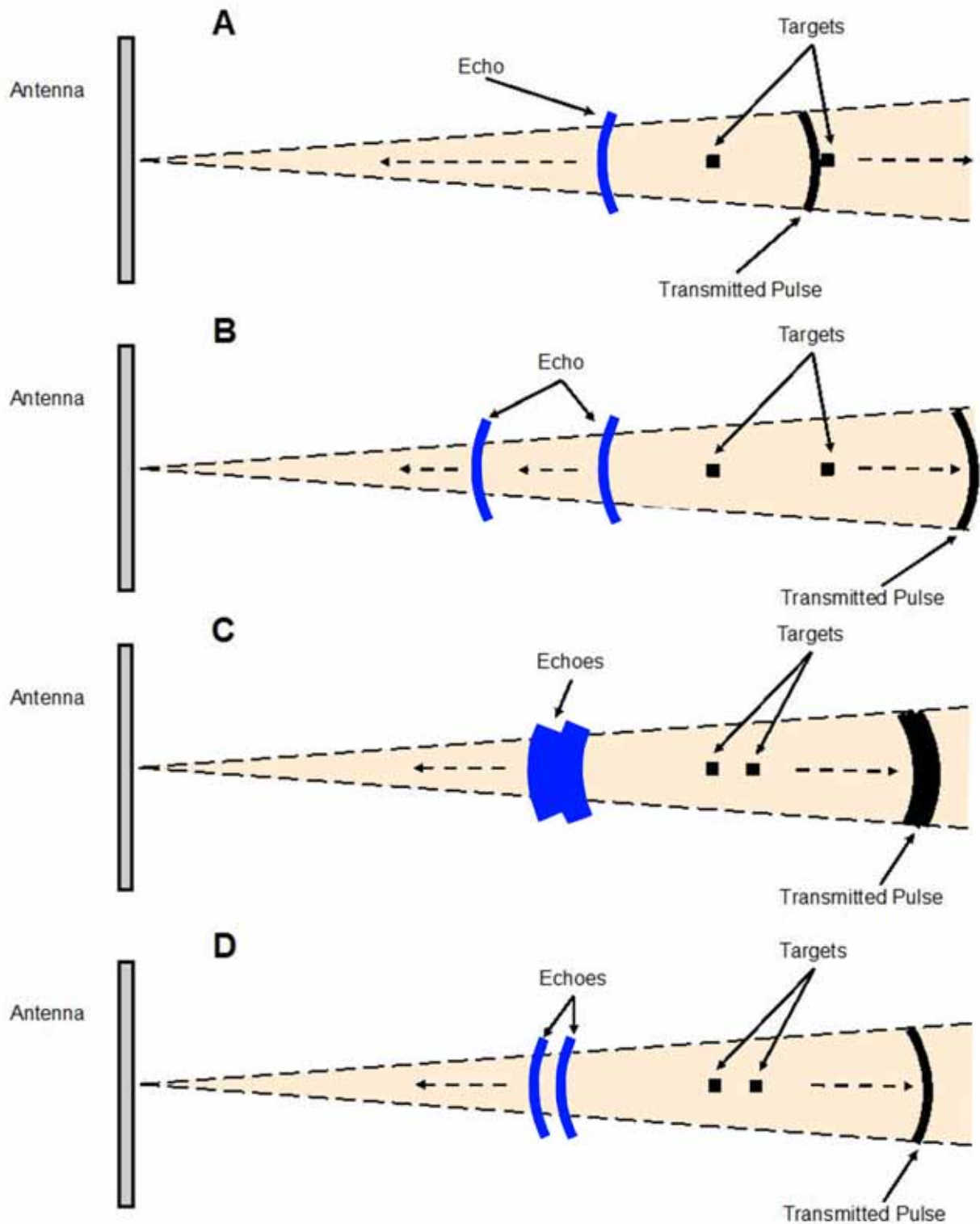

Figure 2309a. Resolution in range.

ables: horizontal beam width and range to the targets. A narrower horizontal beam and/or a shorter distance to the objects will allow for better bearing resolution.

- **Height of Antenna and Target.** If the radar horizon is

between the transmitting vessel and the target, the lower part of the target will not be visible. A large vessel may appear as a small craft, or a shoreline may appear at some distance inland.

- **Reflecting Quality and Aspect of Target.** Echoes from several targets of the same size may be quite different in appearance. A metal surface reflects radio waves more strongly than a wooden surface. A surface perpendicular to the beam returns a stronger echo than a non-perpendicular one. A vessel seen broadside returns a stronger echo than one heading directly toward or away. Some surfaces absorb most radar energy rather than reflecting it.
- **Frequency.** A 3-cm radar has the ability to discern smaller targets than a 10-cm set. For example, a very small boat or a submarine periscope might be invisible in S-Band but detectable in X-Band. In a calm sea, a 3-cm radar, properly tuned, can detect a single bird or even a soda can.

Atmospheric noise, sea return, and precipitation complicate radar interpretation by producing **clutter**. Clutter is usually strongest near the vessel. Strong echoes from targets of interest can sometimes be discerned by reducing receiver gain to eliminate weaker signals. By watching the display during several rotations of the antenna, the operator can often discriminate between clutter and a target even when the signal strengths from clutter and the target are equal. The echoes from real targets will remain relatively stationary on the display while those caused by clutter will appear to move around randomly with each sweep.

Another major problem lies in determining which features in the vicinity of the shoreline are actually represented by echoes shown on the display. Particularly in cases where a low lying shore remains below the radar horizon, there may be considerable uncertainty.

A related problem is that certain features on the shore will not return echoes because they are blocked or shadowed from the radar beam by other physical features or obstructions. This shadowing effect in turn causes the image painted on the display to differ from the charted image of the area.

If the navigator is to be able to interpret the presentation on the radar display, he or she must understand the characteristics of radar propagation, the capabilities of his radar set, the reflecting properties of different types of radar targets, and the ability to analyze his chart to determine which charted features are most likely to reflect the transmitted pulses or to be shadowed. Experience gained during clear weather comparison between radar and visual images is invaluable.

Land masses are generally recognizable because of the steady brilliance of the relatively large areas painted on the PPI. Also, land should be at positions expected from the ship's navigational position. Although land masses are readily recognizable, the primary problem is the identification of specific land features. Identification of specific features can be quite difficult because of various factors in addition to shadowing, including distortion resulting from beam width and pulse length, and uncertainty as to just which charted

features are reflecting the echoes

Sand spits and smooth, clear beaches normally do not appear on the PPI at ranges beyond 1 or 2 miles because these targets have almost no area that can reflect energy back to the radar. Such a smooth horizontal surface will reflect all radar signals away from the antenna and so are essentially invisible. If waves are breaking over a sandbar, echoes may be returned from the surf. Waves may, however, break well out from the actual shoreline, so that ranging on the surf may be misleading.

Mud flats and marshes normally reflect radar pulses only a little better than a sand spit. The weak echoes received at low tide disappear at high tide. Mangroves and other thick growth may produce a strong echo. Areas that are indicated as swamps on a chart, therefore, may return either strong or weak echoes, depending on the density type, and size of the vegetation growing in the area.

Sand dunes covered with vegetation are usually well back from a low, smooth beach, and the apparent shoreline determined by radar appears at the line of the dunes rather than the true shoreline. This can lead navigators to believe they are farther away from the beach than they really are, a potentially hazardous situation.

Lagoons and inland lakes usually appear as blank areas on a PPI because the smooth water surface returns no energy to the radar antenna. In some instances, even the sandbar or reef surrounding the lagoon may not appear on the PPI because it lies too close to the water.

Coral atolls and long chains of islands may produce long lines of echoes when the radar beam is directed perpendicular to the line of the islands. This indication is especially true when the islands are closely spaced. The reason is that the spreading resulting from the width of the radar beam exceeds the radar's resolution in bearing and causes the echoes to blend into continuous lines. When the same chain of islands is viewed lengthwise, or obliquely, however, each island may produce a separate return if the distance between the islands does not exceed the radar's resolution in range.

Surf breaking on a reef around an atoll produces a ragged, variable line of echoes. Even the smallest of rocks projecting above the surface of the water may be discerned depending on their shape and distance from own ship.

If the land rises in a gradual, regular manner from the shoreline, no part of the terrain produces an echo that is stronger than the echo from any other part. As a result, a general haze of echoes appears on the PPI, and it is difficult to ascertain the range to any particular part of the land.

Blotchy echoes are returned from hilly ground, because the crest of each hill returns a good echo though the area beyond is in a radar shadow. If high receiver gain is used, the pattern may become solid except for very deep depressions.

Low islands ordinarily produce small echoes. When thick palm trees or other foliage grow on the island, strong echoes often are produced because the horizontal surface of

the water around the island forms a sort of corner reflector with the vertical surfaces of the trees. As a result, wooded islands give good echoes and can be detected at a much greater range than barren islands.

Sizable land masses may be missing from the radar display because of shadowing. A shoreline which is continuous on the PPI display when the ship is at one position, may not appear continuous when the ship is at another position and scanning the same shoreline. The radar beam may be blocked from a segment of this shoreline by an obstruction such as a promontory. An indentation in the shoreline, such as a cove or bay, appearing on the PPI when the ship is at one position, may not appear when the ship is at another position nearby. Radar shadowing alone can cause considerable differences between the PPI display and the chart presentation. This effect in conjunction with beam width and pulse length distortion of the PPI display can cause even greater differenc-

es, possibly leading to confusion and navigational error.

The returns of objects close to shore may merge with the shoreline image on the PPI, because of distortion effects of horizontal beam width and pulse length. Target images on the PPI are distorted angularly by an amount equal to the effective horizontal beam width. Also, the target images always are distorted radially by an amount at least equal to one-half the pulse length (150 meters per microsecond of pulse length).

See Figure 2309b. It illustrates the effects of own ship position, horizontal beam width, and pulse length on the radar image of a coastline. Because of beam width distortion, a straight, or nearly straight shoreline often appears crescent-shaped on the PPI. This effect is greater with the wider beam widths. Note that this distortion increases as the angle between the beam axis and the shoreline decreases. Figure 2309c, Figure 2309d and Figure 2309e correspond to posi-

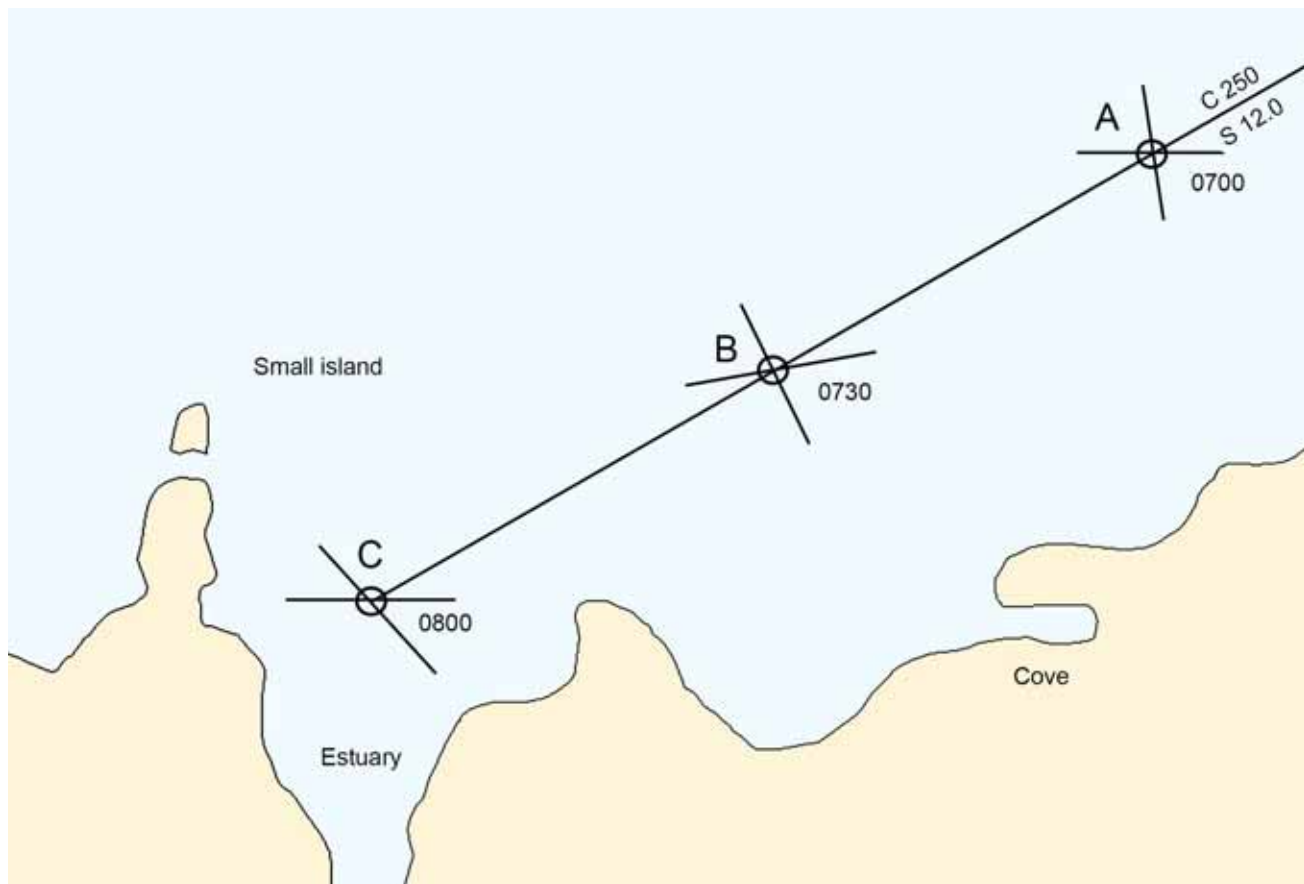

Figure 2309b. Effects of ship's position, beam width, and pulse length on radar shoreline. Figure 2309c, Figure 2309d and Figure 2309e correspond to position A, B and C in the image above.

tions A, B and C in Figure 2309b.

See Figure 2309f. View A shows the actual shape of the shoreline and the land behind it. Note the steel tower on the low sand beach and the two ships at anchor close to shore. The heavy line in View B represents the shoreline on the PPI. The dotted lines represent the actual position and

shape of all targets. Note in particular:

1. The low sand beach is not detected by the radar.
2. The tower on the low beach is detected, but it looks like a ship in a cove. At closer range the land would be detected and the cove-shaped area would begin to fill in; then the tower could not be seen without reducing the receiver gain.

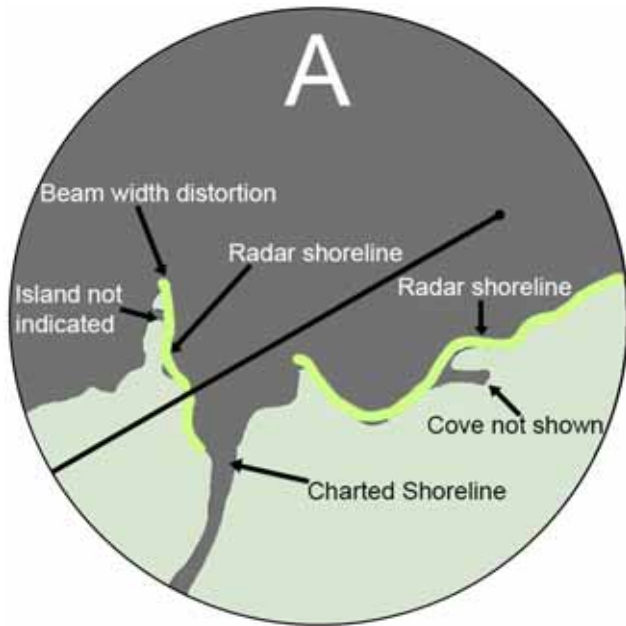

Figure 2309c. 12 mile scale. off-center display at 0700 position. See position A in Figure 2309b.

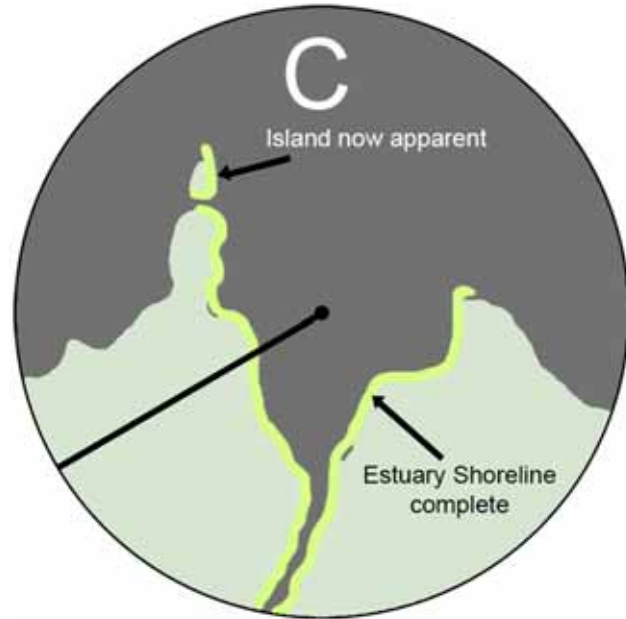

Figure 2309e. 6 mile scale. display center at 0800 position. See position C in Figure 2309b.

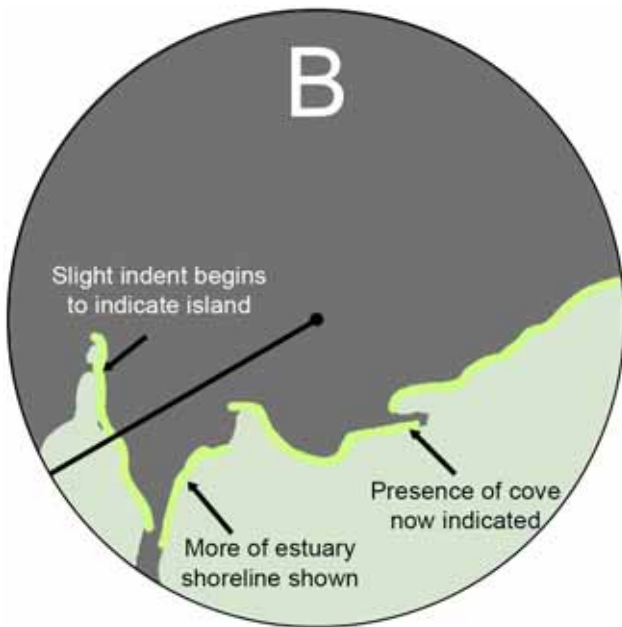

Figure 2309d. 12 mile scale display centered at 0730 position. See position B in Figure 2309b.

3. The radar shadow behind both mountains. Distortion owing to radar shadows is responsible for more confusion than any other cause. The small island does not appear because it is in the radar shadow.
4. The spreading of the land in bearing caused by beam width distortion. Look at the upper shore of the peninsula. The shoreline distortion is greater to the west because the angle between the radar beam and the shore

5. Ship No. 1 appears as a small peninsula. Its return has merged with the land because of the beam width distortion.
6. Ship No. 2 also merges with the shoreline and forms a bump. This bump is caused by pulse length and beam width distortion. Reducing receiver gain might cause the ship to separate from land, provided the ship is not too close to the shore. The rain clutter control could also be used to attempt to separate the ship from land by effectively reducing the pulse lengths within the receiver.

2310. Recognition of Unwanted Echoes

Indirect or false echoes are caused by reflection of the main lobe of the radar beam off own ship's structures such as masts, stacks, kingposts or deck cargo, especially containers. When such reflection from obstructions does occur, the echo will return from a legitimate radar contact to the antenna by the same indirect path. Consequently, the echo will appear on the PPI at the bearing of the reflecting surface. As shown in Figure 2310a, the indirect echo will appear on the PPI at the same range as the direct echo received, assuming that the additional distance by the indirect path is negligible.

Characteristics by which indirect echoes may be recognized are summarized as follows:

1. Indirect echoes will often occur in shadow sectors.
2. They are received on substantially constant relative bearings (the direction of the obstruction), although the true bearing of the radar contact may change

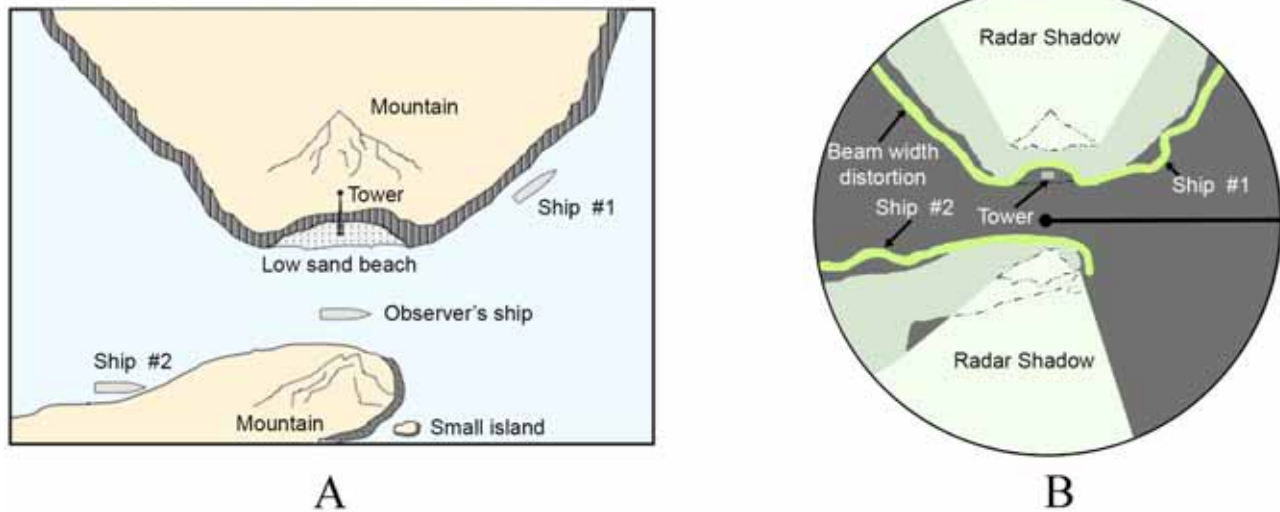

Figure 2309f. Distortion effects of radar shadow, beam width, and pulse length.

appreciably.

3. They appear at the same ranges as the corresponding direct echoes.
4. When plotted, their movements are usually abnormal.
5. Their distorted or fuzzy shapes may indicate that they are not direct echoes.

Side-lobe effects are readily recognized in that they produce a series of echoes (See Figure 2310b) on each side of the main lobe echo at the same range as the latter. Semi-circles, or even complete circles, may be produced. Because of the low energy of the side-lobes, these effects will normally occur only at the shorter ranges. The effects may be minimized or eliminated, through use of the gain and anti-clutter controls, but always at the risk of failing to detect weaker targets like buoys or small boats. The introduction of slotted wave guide antennas has drastically reduced the side-lobe problem. Nevertheless, when strong reflecting targets are present at close range, side lobe effects will still be encountered and may be difficult to eliminate entirely without severely reducing gain.

Multiple echoes may occur when a strong echo is received from another ship at close range. A second or third or more echoes may be observed on the radarscope at double, triple, or other multiples of the actual range of the radar contact (Figure 2310c).

Second-trace echoes (multiple-trace echoes) are echoes received from a contact at an actual range greater than the radar range setting. If an echo from a distant target is received after the next pulse has been transmitted, the echo will appear on the display at the correct bearing but not at the true range. Second-trace echoes are unusual, except under abnormal atmospheric conditions, or conditions under which super-refraction or ducting is present. Second-trace echoes may be recognized through changes in their

positions on the display when changing range scales with different pulse repetition rates (PRR), their hazy, streaky, or distorted shapes (especially noticeable with large land targets), and their erratic movements on plotting.

As illustrated in Figure 2310d, a target echo is detected on a true bearing of 090° at a distance of 7.5 miles. On changing the PRR from 2,000 to 1,800 pulses per second in Figure 2310e, the same target is detected on a bearing of 090° at a distance of 3 miles. The change in the position of the target indicates that the echo is a second-trace echo. The actual distance of the target is the distance as indicated on the PPI plus half the distance the radar waves travel between pulses. In this case,

$$(162,000 \text{ NM/sec} \div 2000 \text{ PPS} \div 2) + 7.5 = 48 \text{ nautical miles.}$$

Naturally, since we are on the 12-mile scale, the target should not be visible and so must be a second-trace echo.

Electronic interference effects, which may occur when near another radar operating in the same frequency band as that of own ship, are usually seen on the radar as a large number of small bright dots either scattered at random or in the form of curving dotted lines extending from the center to the edge of the PPI.

Interference effects are greater at the longer radar range scale settings. Interference effects can be distinguished easily from normal echoes because they do not appear in the same places on successive rotations of the antenna. Most radar systems have interference rejection controls (IR) that eliminate most of the unwanted interference effects.

Stacks, masts, containers, and other structures, may cause a reduction in the intensity of the radar beam beyond these obstructions, especially if they are close to the radar antenna. If the angle at the antenna subtended by the obstruction is more

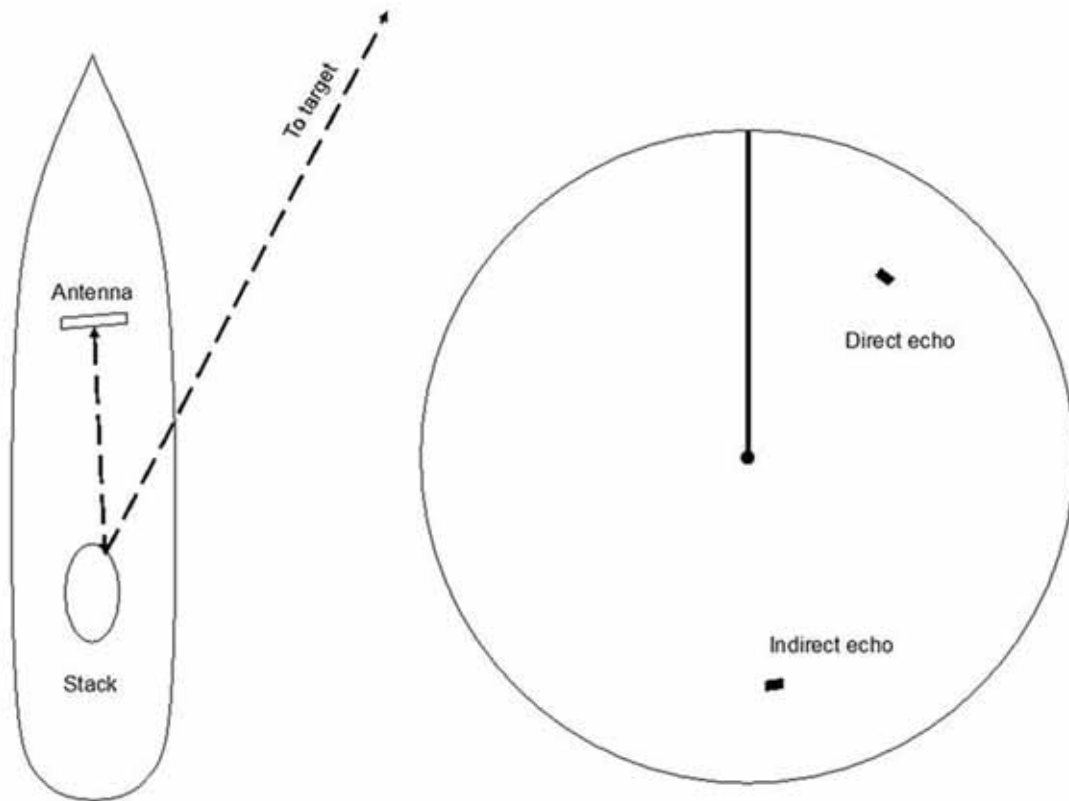

Figure 2310a. Indirect echo.

reduction in the intensity of the beam beyond the obstructions may produce shadow sectors. Within a shadow sector, small targets at close range may not be detected, while larger targets at much greater ranges will appear.

The echo from an overhead power cable can be wrongly identified as the echo from a ship on a steady bearing and decreasing range. Course changes to avoid the contact are ineffective; the contact remains on a steady bearing, decreasing range. This phenomenon is particularly apparent for the power cable spanning the Straits of Messina.

2311. Aids to Radar Navigation

Radar navigation aids help identify radar targets and increase echo signal strength from otherwise poor radar targets.

Buoys are particularly poor radar targets. Weak, fluctuating echoes received from these targets are easily lost in the sea clutter. To aid in the detection of these targets, **radar reflectors**, designated corner reflectors, may be used. These reflectors may be mounted on the tops of buoys or designed into the structure.

Each corner reflector, as shown in Figure 2311a, consists of three mutually perpendicular flat metal surfaces. A radar wave striking any of the metal surfaces or plates

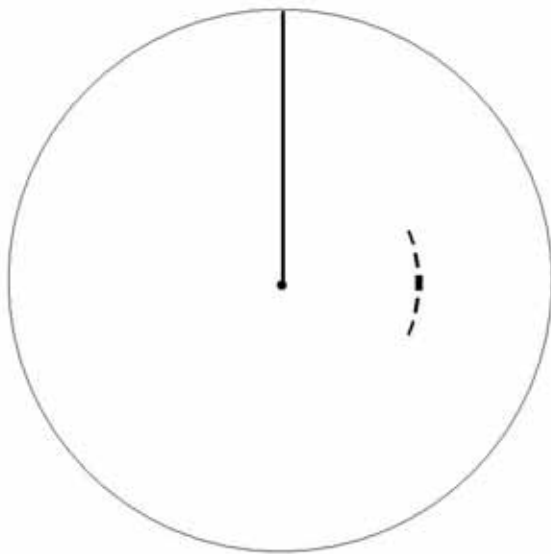

Figure 2310b. Side lobe effects.

than a few degrees, the reduction of the intensity of the radar beam beyond the obstruction may produce a blind sector. Less

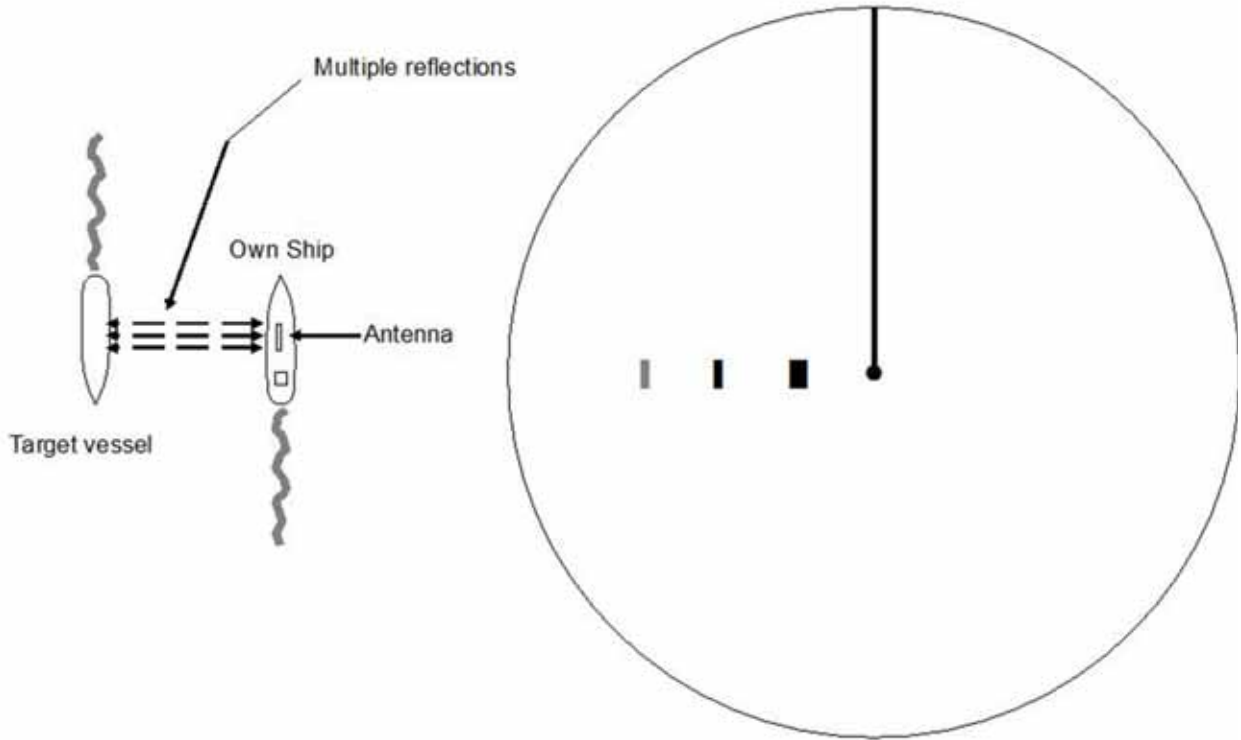

Figure 2310c. Multiple echoes.



Figure 2310d. Second-trace echo.

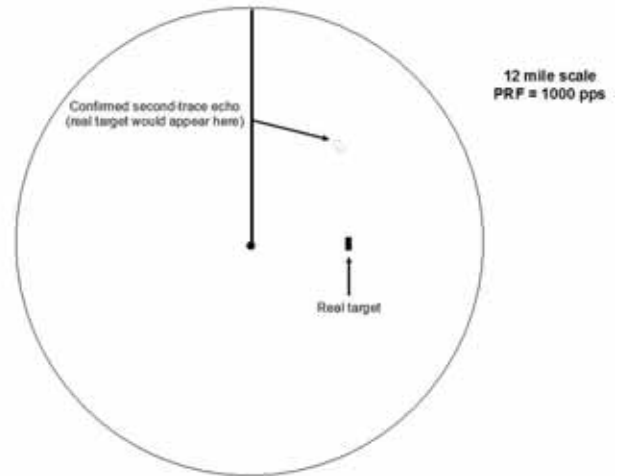

Figure 2310e. Second-trace echo after altering PRR.

will be reflected back in the direction of its source. Maximum energy will be reflected back to the antenna if the axis of the radar beam makes equal angles with all the metal surfaces. Frequently, corner reflectors are assembled in clusters to maximize the reflected signal.

Although radar reflectors are used to obtain stronger echoes from radar targets, other means are required for more

positive identification of radar targets. **Radar beacons** are transmitters operating in the marine radar frequency band, which produce distinctive indications on the radar displays of ships within range of these beacons. There are two general classes of these beacons: **racons**, which provide both bearing and range information to the target, and **ramarks** which provide bearing information only. However, if the

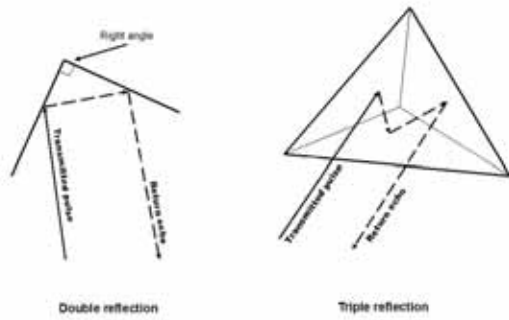

Figure 2311a. Corner reflectors.

ramark installation is detected as an echo on the display, the range will be available also.

A racon is a radar transponder which emits a characteristic signal when triggered by a ship's radar. The signal is emitted on the same frequency as that of the triggering radar, in which case it is superimposed on the ship's radar display automatically. However, the only racons in service are "in band" beacons which transmit in one of the marine radar bands, usually only the 3-centimeter band.

The racon signal appears on the PPI as a radial line originating at a point just beyond the position of the radar beacon, or as a Morse Code signal as shown in Figure 2311b, emanating from the beacon in a direction radially outward from the center of the display. The Morse Code symbol of the racon signal helps to identify important navigational aids on the navigator's chart.

A ramark is a radar beacon which transmits either continuously or at intervals. The latter method of transmission is used so that the PPI can be inspected without any clutter introduced by the ramark signal on the scope. The ramark signal as it appears on the PPI is a radial line from the center. The radial line may be a continuous narrow line, a broken line a series of dots, or a series of dots and dashes (See Figure 2311c). Ramarks are not as common as racons and are not as useful for navigational purposes as they do not indicate the range to the transmitting beacon.

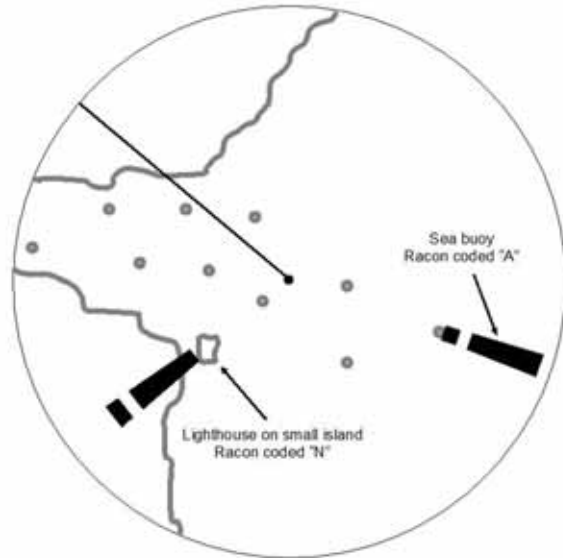

Figure 2311b. Coded racon signal.

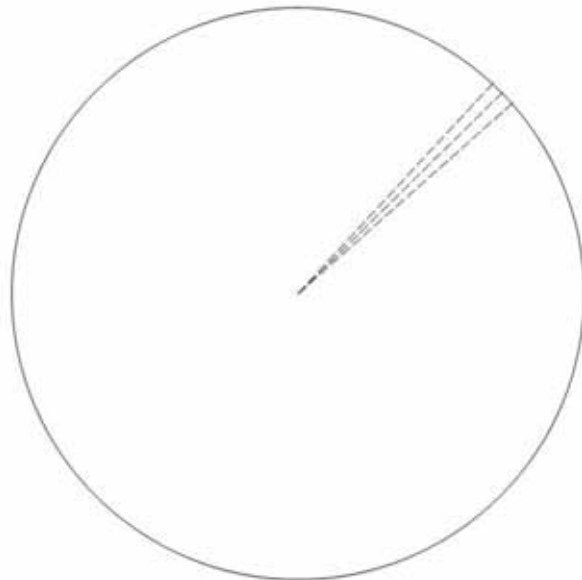

Figure 2311c. Ramark appears a broken radial line.

RADAR PILOTING

2312. Introduction

When navigating in restricted waters, a mariner most often relies on visual piloting to provide the accuracy required to ensure ship safety. Visual piloting, however, requires clear weather; often, mariners must navigate through fog or other conditions of restricted visibility. When weather conditions render visual piloting impossible

on a vessel not equipped with ECDIS, radar navigation provides a method of fixing a vessel's position with sufficient accuracy to allow safe passage. See Chapter 10 Piloting for a detailed discussion of integrating radar into a piloting procedure on a vessel using paper charts. However, even on ECDIS equipped vessels, radar provides a vital positional cross-checking capability that is paramount to the practice of safe and prudent navigation.

2313. Fix by Radar Ranges

Since radar can more accurately determine ranges than bearings, the most accurate radar fixes result from measuring and plotting a series of ranges to two or more objects. If one measures the range to objects directly ahead or astern first and objects closest to the beam last, the time of the fix will be the time the ranges were measured to objects ahead or astern. In other words, the fix time is the time that distances were measured to objects with the greatest rate of change of range (range rate) due to own ship's motion. This minimizes measurement time delay errors without resorting to the use of running fixes. Record the ranges to the navigation aids used and lay the resulting range arcs down on the chart. Theoretically, these lines of position should intersect at a point coincident with the ship's position at the time of the fix. Where possible, use objects widely separated in bearing (60° - 90°) for the greatest accuracy. See Figure 2313.

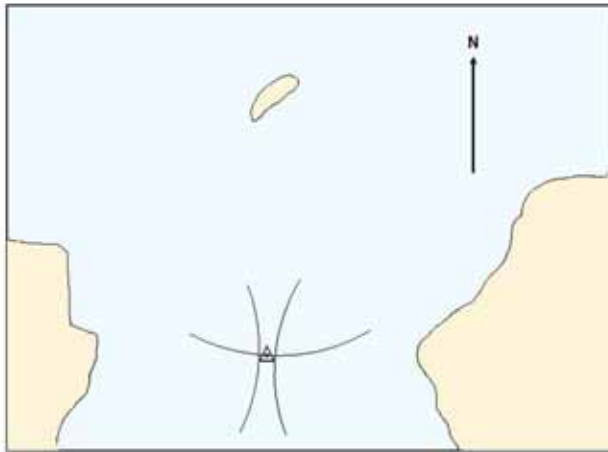

Figure 2313. Fix by radar ranges.

Though verifying soundings is always a good practice in all navigation scenarios, its importance increases when piloting using only radar. One of the most common and serious errors in radar navigation involves object misidentification. These errors can be discovered through correlation of fathometer readings with expected charted depths. Assuming proper operation of the fathometer, soundings give the navigator invaluable conformation on the reliability of radar fixes.

2314. Fix by Radar Bearings

When determining a fix by radar bearings (or visual bearings) take bearings of objects on the beam first and those ahead or astern last. The time of the fix will be the time that the objects abeam were measured. This is because the rate of change of bearing is highest for objects on the beam and lowest for those ahead and astern. Again, this procedure minimizes the fix error due to the time delay in

taking a round of bearings.

But the inherent inaccuracy of fixes composed solely of radar bearings as discussed above makes this method less accurate than fixing position by radar ranges. Use this method to plot a position quickly on the chart when approaching restricted waters to obtain an approximate ship's position for evaluating radar targets to use for range measurements. This method is not suitable while piloting in restricted waters and should only be used if no more accurate method (combining visual bearings with radar ranges for example) is available.

2315. Fix by Range and Bearing to One Object

Visual piloting requires bearings from at least two objects; radar, with its ability to determine both bearing and range from one object, allows the navigator to obtain a fix where only a single navigation aid is available. An example of using radar in this fashion occurs in approaching a harbor whose entrance is marked with a single, prominent object such as Chesapeake Light at the entrance of the Chesapeake Bay. Well beyond the range of any land-based visual navigation aid, and beyond the visual range of the light itself, a shipboard radar can detect the light and provide bearings and ranges for the ship's piloting party. But care should be taken. Navigators must ensure they take fixes on the navigation aid and not some nearby stationary vessel.

This methodology is limited by the inherent inaccuracy associated with radar bearings; typically, a radar bearing is accurate to within about 5° of the true bearing due to factors such as beam width distortion. Therefore, the navigator must carefully evaluate the resulting position, possibly checking it with a sounding. If a visual bearing is available from the object, use that bearing instead of the radar bearing when laying down the fix. This illustrates the basic concept discussed above: radar ranges are inherently more accurate than radar bearings. One must also be aware that even though the radar is gyro stabilized, there may be a gyro error of more than a degree or so. Radar and visual bearings will be in error by that amount.

Prior to using this method, navigators must ensure they have correctly identified the object from which the bearing and range are to be taken. Using only one navigation aid for both lines of position can lead to disaster if the navigation aid is not properly identified.

2316. Fix Using Tangent Bearings and Range

This method combines bearings tangent to an object with a range measurement from some point on that object. The object must be large enough to provide sufficient bearing spread between the tangent bearings; often an island or peninsula works well. Identify some prominent feature of the object that is displayed on both the chart and the radar display. Take a range measurement from that feature and

plot it on the chart. Then determine the tangent bearings to the feature and plot them on the chart. The range LOP should not intersect where the tangent bearing LOPs intersect but somewhat farther out. The fix position will be the point midway between the tangent bearing lines along the range LOP (see Figure 2316).

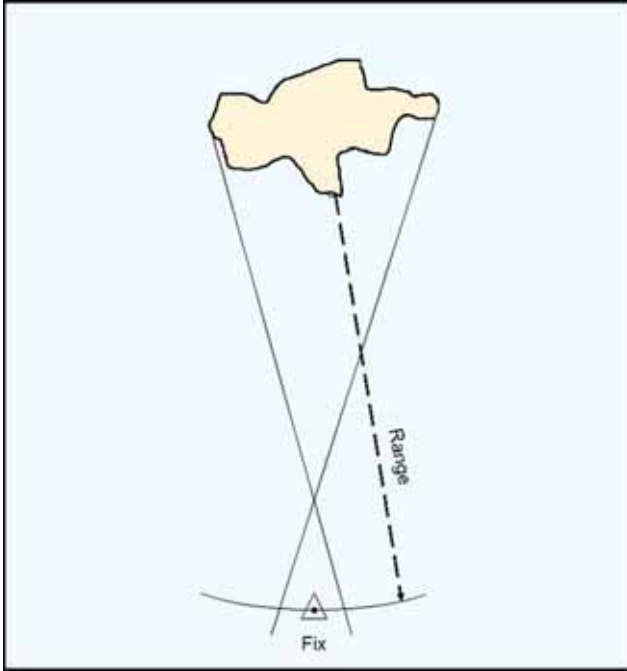

Figure 2316. Fix using tangent bearings and range.

Steep-sided features work the best. Tangents to low, sloping shorelines will seriously reduce accuracy, as will tangent bearings in areas of excessively high tides, which can change the location of the apparent shoreline by many meters.

2317. Parallel Indexing

Whenever a vessel is being navigated in confined waters, traditional position fixing methods become inadequate. The time lag inherent in taking a visual bearing, radar bearing or radar range, plotting positions on a nautical chart, obtaining a fix, and then acting on the information with a possible course change may be as much as five minutes or more, even for experienced navigators. If sea room is severely restricted and there are hazards to navigation in the area, such delays could lead to disaster. What we must do in this unforgiving situation is to monitor the vessel's position constantly through continuous position fixes. ECDIS is of course greatly preferable to paper chart navigation in these circumstances but suffers from complete reliance on GPS position fixes. Radar can provide similar real-time navigation capability not reliant on GPS utilizing a technique known as parallel indexing.

A properly prepared parallel indexing plot will quickly show the navigator when the vessel begins to deviate from the

desired track. This will enable corrective measures to be taken immediately without resorting to time-consuming standard fixing methods. Parallel indexing can be indispensable when a vessel must be navigated through confined waters during restricted visibility or when executing a critical turn. Also, in areas with few or unreliable navigational aids, parallel indexing can prove decisive to safe navigation.

The first step in setting up a parallel indexing plot is to examine the nautical chart where the piloting will take place. Imagine that we wish to follow a track line that leaves a small island or rock to starboard at a distance of 2 miles off when abeam. The track line course is 045° (see Figure 2317). If we are able to place an electronic line on the radar screen bearing 045°-225° at a range of 2 miles to starboard, all we will have to do when the island comes onto the radar display is to maneuver the ship to keep the island on that line which in turn locates (indexes) the vessel on the track line.

One way to conduct parallel indexing on a modern radar display is to utilize the Electronic Bearing Line (EBL) feature. Most radars have the ability to offset the EBL from the center of the display. This allows it to be used as a single parallel index line. Once the EBL bearing is set to that of the vessel's track line, the origin can be floated out to the desired distance tangent to a Variable Range Marker (VRM) set to that distance.

Modern radar sets are usually fitted with a dedicated parallel indexing (PI) feature that may take many forms depending on the radar manufacturer, and are easier to use than the floating EBL. While the details of these PI features may be quite different, they all have the following in common:

1. The display of an electronic PI line, wholly or partially across the radar screen
2. The PI line is adjustable in direction (bearing) and distance (range) from own ship
3. Once set at desired bearing and range, the PI line is fixed relative to own ship

It is vital that when placing a single PI line on the radar display, the bearing of the line is set first, then the range. If done in reverse order, the distance of the PI line from own ship to target will be less than desired.

The method described above is very basic and utilizes only a single index line and a single index target. But the level of sophistication of indexing required varies with the situation. A passage may call for many lines on different scales, multiple index targets, margin lines, danger zones and wheel over points. The more complicated the setup, of course, the more time and effort on the part of the navigator is demanded. More complex indexing schemes, however elegant, also carry a greater risk of error in construction. A point will be reached where there is little to be gained by an excessively elaborate setup because it may also lead to a more cluttered and confusing radar display. A vessel that

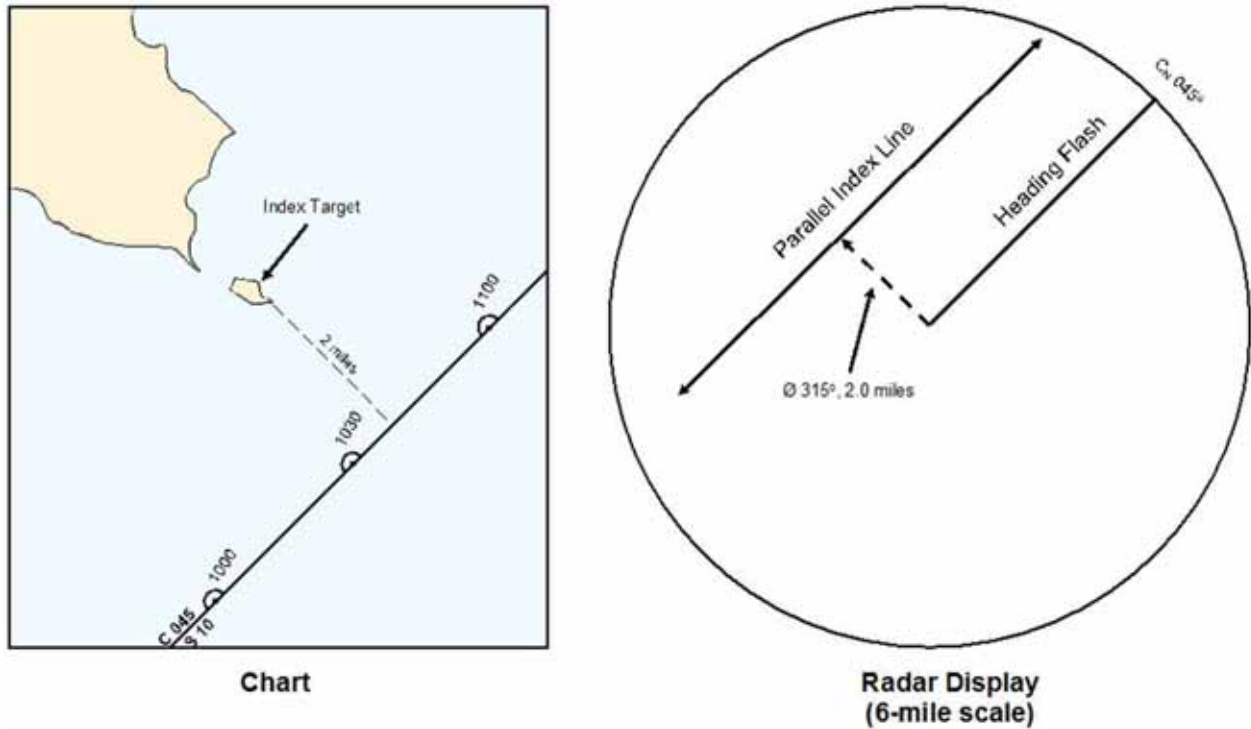

Figure 2317. Parallel indexing setup.

routinely makes passages through navigationally challenging waters would be better advised to rely more on the ECDIS and use a simpler parallel indexing setup on the radar as a backup and for cross checking.

2318. References

Pecota, S., (2006). *Radar Observer Manual*, 6th. Marine Education Textbooks. Section 2317 **reprinted with permission.**

CHAPTER 24

LORAN NAVIGATION

INTRODUCTION TO LORAN

2400. History and Role of Loran

The theory behind the operation of hyperbolic navigation systems was known in the late 1930s, but it took the urgency of World War II to speed development of the system into practical use. By early 1942, the British had an operating hyperbolic system in use designed to aid in long-range bomber navigation. This system, named Gee, operated on frequencies between 30 MHz and 80 MHz and employed “master” and “slave” transmitters spaced approximately 100 miles apart. The Americans were not far behind the British in development of their own system. By 1943, the U. S. Coast Guard was operating a chain of hyperbolic navigation transmitters that became **Loran-A** (The term Loran was originally an acronym for LOnG RAnge Navigation). By the end of the war, the network consisted of over 70 transmitters providing coverage over approximately 30% of the earth's surface.

In the late 1940s and early 1950s, experiments in low frequency Loran produced a longer range, more accurate system. Using the 90-110 kHz band, Loran developed into a 24-hour-a-day, all-weather radionavigation system named **Loran-C**. From the late 1950s, Loran-A and Loran-C systems were operated in parallel until the mid-1970s when the U.S. Government began phasing out Loran-A. The United States continued to operate Loran-C in a number of areas around the world, including Europe, Asia, the Mediterranean Sea, and parts of the Pacific Ocean until the mid-1990s when it began closing its overseas Loran-C stations or transferring them to the governments of the host countries. This was a result of the U.S. Department of Defense adopting the Global Positioning System (GPS) as its primary radionavigation service.

From the 1990s until 2010, Loran served the 48 contiguous states within the United States, their coastal areas, Alaska, and nine of 13 provinces in Canada. North American Loran-C signals, however, were terminated in 2010 in accordance with the 2010 Department of Homeland Security Appropriations Act. The United States Coast Guard ceased transmitting Loran-C signals on 08 FEB 2010 across most of the United States. On 03 AUG 2010, US stations that operated in concert with Canadian stations, and the Canadian stations themselves, ceased transmitting. The United States government began dismantling former Loran-C stations until 2014 when the “Howard Coble Coast Guard and Maritime Transportation Act of 2014” was signed into law.

The “Coast Guard Authorization Act of 2015” extended this provision until the Secretary of the agency overseeing the Coast Guard could justify that the Loran-C infrastructure was not needed as a backup to GPS.

As of early 2014, various countries still had operational Loran-C transmitters (or Loran-C equivalents such as the Russian Chayka system) including China, India, Japan, Northwest Europe (e.g., United Kingdom, France, Norway, Germany, and Denmark), Russia, Saudi Arabia, and South Korea. In 2014, Norway and France announced that they would shut down their transmitters on 31 December 2015. Sites in Denmark, Germany, and the U.K. subsequently decided to shut down transmitters as well though the Anthorn transmitter in Cumbria (U.K.) remains active.

In 2001, the “Volpe” report (United States Department of Transportation 2001) outlined key vulnerabilities in the reliance of GPS for critical infrastructure needs. This report (United States Department of Transportation 2001) was the first to mention the use of **Enhanced Loran** or **eLoran** as it is now called. eLoran was conceived and designed as a modern, 21st century replacement to Loran-C. eLoran was outlined as a backup navigational and timing method to a Global Navigation Satellite System (GNSS) such as GPS in instances where a GNSS system may be unavailable or untrustworthy. It was conceived as a result of the “Loran Modernization Program” and has greater accuracy than Loran-C and new features (International Loran Association 2007). The eLoran definition document, stating the design of the eLoran system, was released on 16 October 2007 (International Loran Association 2007) outlining the requirements that this new method must have and how it differs from Loran-C. As of 2016 eLoran is currently being tested at stations across the United States (UrsaNav 2015). South Korea is set to build eLoran stations in response to North Korean GPS jamming (GPS World 2016) and other countries are seeking to build eLoran infrastructure. With the cessation of signals in Northwest Europe on 31 December 2015, eLoran is no longer available for navigational use anywhere in the world. The UK continues to operate their Anthorn eLoran station for the provision of data communications and timing. eLoran signals are also transmitted from the former USCG Loran Support Unit in Wildwood, New Jersey as part of a Cooperative Research and Development Agreement (CRADA) between the DHS, USCG, UrsaNav, and Harris Corporation.

Additional information on eLoran may be found at the

end of this chapter. See Section 2418.

LORAN-C DESCRIPTION

2401. Summary of Operation

The Loran-C signal is still transmitted on a continuous basis from stations in China, South Korea, and the Kingdom of Saudi Arabia. Additionally, the Chayka signal is still transmitted from stations in Russia. Modern Enhanced Loran (eLoran) is intermittently tested in the UK and US. Legacy Loran-C receivers can be used with eLoran. However, legacy receivers cannot take advantage of the Loran Data Channel, a key component of eLoran that is necessary to achieve the enhanced capabilities. All of the information presented about Loran-C is given because it is the basis of Loran-C navigation and all Loran-C navigation methods would also apply using eLoran. Some information and aids, such as Loran-C charts are not directly available or maintained by the United States government.

The Loran-C (hereafter referred to simply as Loran) system consists of **transmitting stations**, which are placed several hundred miles apart and organized into **chains**. Within a Loran chain, one station is designated as the master station and the others as **secondary stations**. Every Loran chain contains at least one master station and two secondary stations in order to provide at least two lines of position (LOP).

The master and secondary stations transmit radio pulses at precise time intervals. A Loran receiver measures the **time difference** (or time delay) (**TD**) between the vessel's receipt of the master and secondary station signal transmissions. The elapsed time is converted to distance, the locus of points having the same TD between the master and secondary forms the hyperbolic LOP. The navigator records the delayed TD values and applies them to the chart by interpolating between the printed lattice lines, manually plotting the LOPs parallel to lattice lines. The intersection of two or more of these LOPs produces a fix of the vessel's position.

There are two methods by which the navigator can convert this information into a geographic position. The first involves the use of a chart overprinted with a Loran **time delay lattice** consisting of hyperbolic TD lines spaced at convenient intervals. The navigator plots the displayed TDs by interpolating between the lattice lines printed on the chart, manually plotting the fix where lines intersect to determine latitude and longitude. In the second method, computer algorithms in the receiver's software convert the TDs to latitude and longitude for display.

As with other computerized navigation receivers, a typical Loran receiver can accept and store **waypoints**. Waypoints are sets of coordinates that describe either locations of navigational interest or points along a planned route. Waypoints may be entered by visiting the spot of interest and pressing the appropriate receiver control key, or

by keying in the waypoint coordinates manually, either as a TD or latitude-longitude pair. If using waypoints to mark a planned route, the navigator can use the receiver to monitor the vessel's progress in relation to the track between each waypoint. By continuously providing parameters such as cross-track error, course over ground, speed over ground, and bearing and distance to next waypoint, the receiver continually serves as a check on the primary navigation plot.

2402. Components of the Loran System

For the marine navigator, the components of the Loran system consist of the land-based transmitting stations, the Loran **receiver** and **antenna**, and the **Loran charts**. In addition to the master and secondary transmitting stations, land-based Loran facilities also include the primary and secondary **system area monitor sites**, the **control station** and a precise time reference. The transmitters emit Loran signals at precisely timed intervals. The monitor sites and control stations continually measure and analyze the characteristics of the Loran signals received to detect any anomalies or out-of-specification conditions. Some transmitters serve only one function within a chain (i.e., either master or secondary). However, in many instances, one transmitter transmits signals for each of two adjacent chains. This practice is termed **dual rating**.

Loran receivers exhibit varying degrees of sophistication, but their signal processing is similar. The first processing stage consists of **search and acquisition**, during which the receiver searches for the signal from a particular Loran chain and establishes the approximate time reference of the master and secondaries with sufficient accuracy to permit subsequent settling and tracking.

After search and acquisition, the receiver enters the **settle** phase. In this phase, the receiver searches for and detects the front edge of the Loran pulse. After detecting the front edge of the pulse, it selects the correct cycle of the pulse to track.

Having selected the correct tracking cycle, the receiver begins the **tracking and lock** phase, in which the receiver maintains synchronization with the selected received signals. Once this phase is reached, the receiver displays either the time difference of the signals or the computed latitude and longitude.

2403. The Loran Signal

The Loran signal consists of a series of 100 kHz pulses sent first by the master station and then, in turn, by the secondary stations. Both the shape of the individual pulse and the pattern of the entire pulse sequence are shown in Figure 2403a. As compared to a carrier signal of constant amplitude, pulsed transmission allows the same signal range to be

achieved with a lower average output power. Pulsed transmission also yields better signal identification properties and more precise timing of the signals.

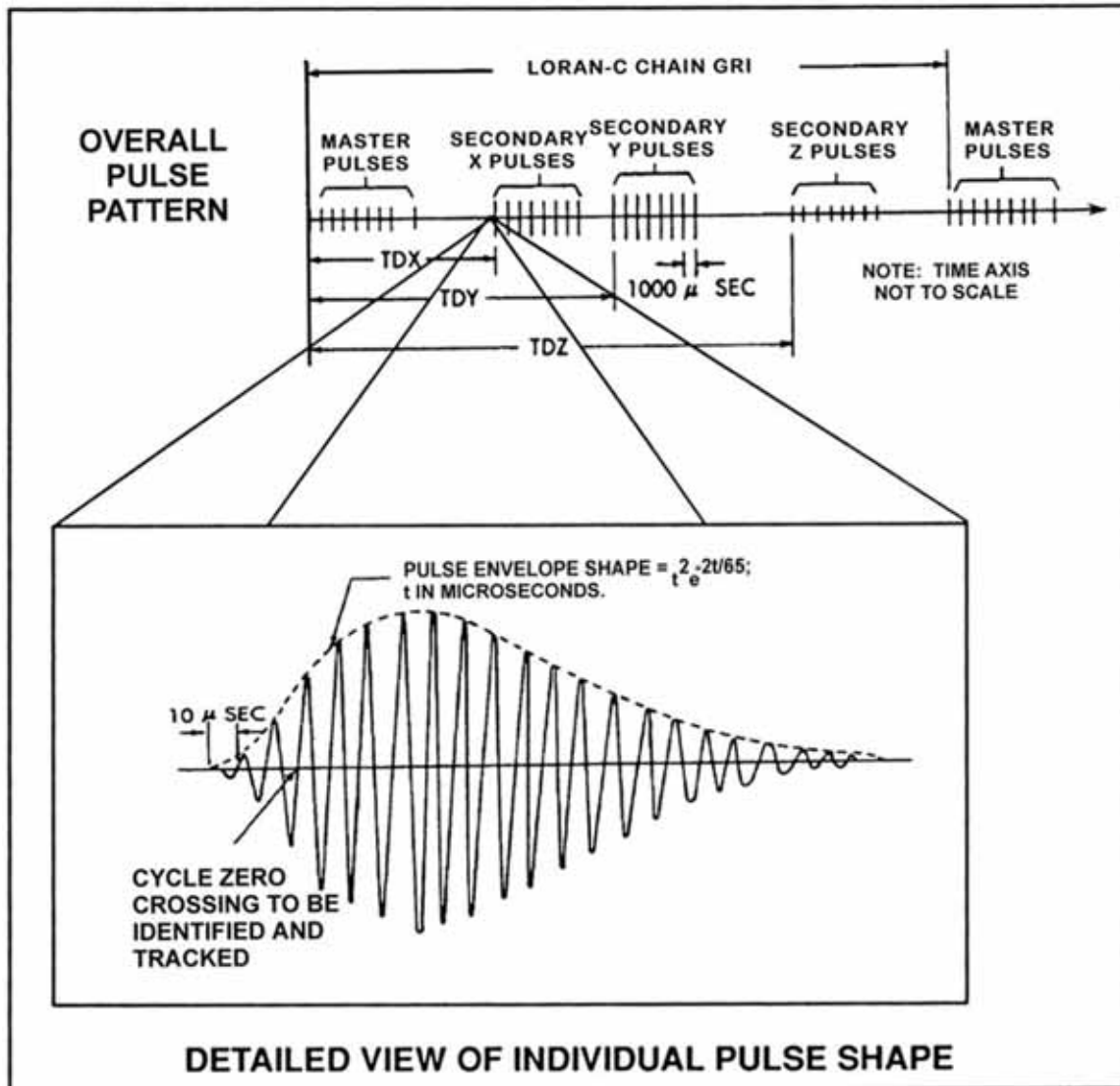

Figure 2403a. Pulse pattern and shape for Loran C transmission.

The individual sinusoidal Loran pulse exhibits a steep rise to its maximum amplitude within 65 μsec of emission and an exponential decay to zero within 200 to 300 μsec. The signal frequency is nominally defined as 100 kHz; in actuality, the signal is designed such that 99% of the radiated power is contained in a 20 kHz band centered on 100 kHz.

The Loran receiver is programmed to track the signal on the cycle corresponding to the carrier frequency's third positive crossing of the x-axis. This occurrence, termed the **standard zero crossing**, is chosen for two reasons. First, it is late enough for the pulse to have built up sufficient signal strength for the receiver to detect it. Second, it is early enough in the pulse to ensure that the receiver is detecting the transmitting station's ground wave pulse and not its sky

wave pulse. Sky wave pulses are affected by atmospheric refraction and, if used unknowingly, would introduce large errors into positions determined by a Loran receiver. The pulse architecture described here reduces this major source of error.

Another important parameter of the pulse is the **envelope-to-cycle difference (ECD)**. This parameter indicates how propagation of the signal causes the pulse shape envelope (i.e., the imaginary line connecting the peak of each sinusoidal cycle) to shift in time relative to the zero crossings. The ECD is important because Loran-C receivers use the precisely shaped pulse envelope to identify the correct zero crossing. Transmitting stations are required to keep the ECD within defined limits. Many receivers display the received ECD as well.

Next, individual pulses are combined into sequences. For the master signal, a series of nine pulses is transmitted, the first eight spaced 1000 μsec apart followed by a ninth transmitted 2000 μsec after the eighth. Secondary stations transmit a series of eight pulses, each spaced 1000 μsec apart. Secondary stations are given letter designations of V, W, X, Y, and Z; this letter designation indicates the order in which they transmit following the master. If a chain has two secondaries, they will be designated Y and Z. If a chain has three secondaries, they are X, Y and Z, and so on. Some exceptions to this general naming pattern exist (e.g., W, X and Y for some 3-secondary chains).

The spacing between the master signal and each of the secondary signals is governed by several parameters as illustrated in Figure 2403b. The general idea is that each of

the signals must clear the entire chain coverage area before the next one is transmitted, so that no signal can be received out of order. The time required for the master signal to travel to the secondary station is defined as the average **baseline travel time (BTT)**, or **baseline length (BLL)**. To this time interval is added an additional delay defined as the **secondary coding delay (SCD)**, or simply **coding delay (CD)**. The total of these two delays is termed the **emission delay (ED)**, which is the exact time interval between the transmission of the master signal and the transmission of the secondary signal. Each secondary station has its own ED value. To ensure the proper sequence, the ED of secondary Y is longer than that of X, and the ED of Z is longer than that of Y.

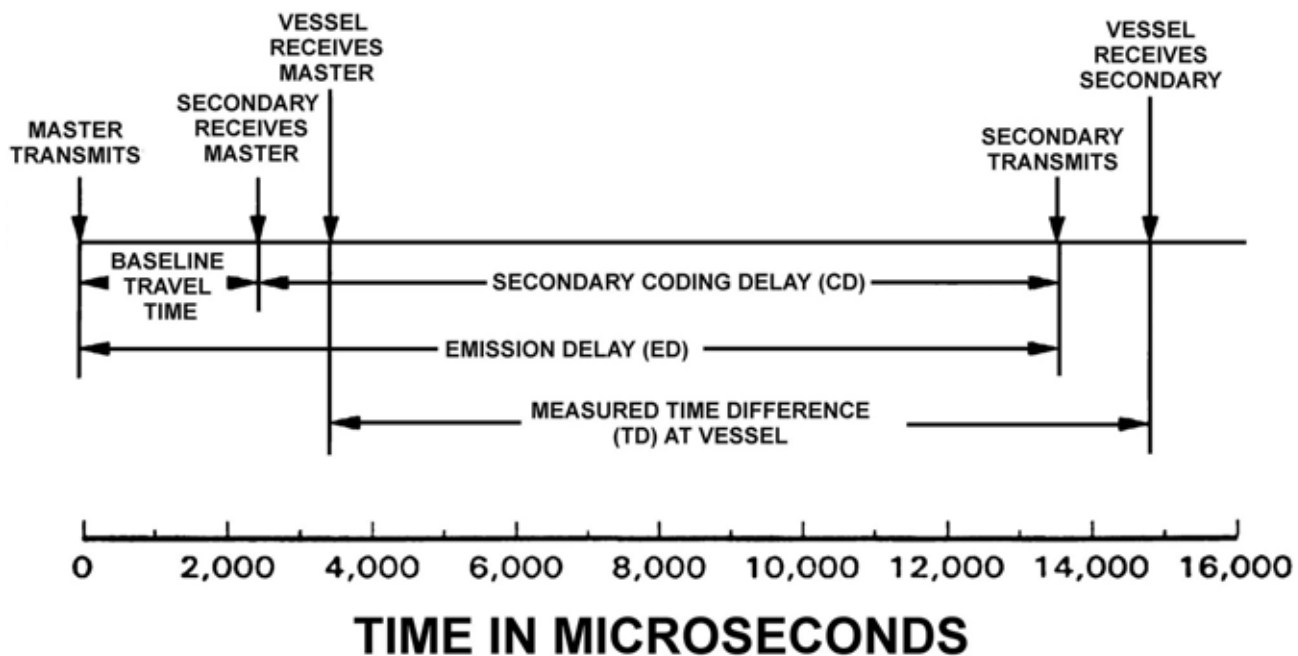

Figure 2403b. The time axis for Loran TD for point "A."

Once the last secondary has transmitted, the master transmits again, and the cycle is repeated. The time to complete this cycle of transmission defines an important characteristic for the chain: the **group repetition interval (GRI)**. The group repetition interval divided by ten yields the chain's numeric designator. For example, the interval between successive transmissions of the master pulse group for the Northeast U.S. Chain (commonly referred to as "NEUS") is 99,600 μsec , just less than one tenth of a second. From the definition above, the GRI designator for this chain is defined as 9960. As mentioned previously, the GRI must be sufficiently large to allow the signals from the master and secondary stations in the chain to propagate fully throughout the region covered by the chain before the next cycle of pulses begins.

Two additional characteristics of the pulse group are

phase coding and **blink coding**. In phase coding, the phase of the 100 kHz carrier signal is reversed from pulse to pulse in a preset pattern that repeats every two GRIs. Phase coding allows a receiver to remove skywave contamination from the groundwave signal. Loran-C signals travel away from a transmitting station in all possible directions. Groundwave is the Loran energy that travels along the surface of the earth. Skywave is Loran energy that travels up into the sky. The ionosphere reflects some of these skywaves back to the earth's surface. The skywave always arrives later than the groundwave because it travels a greater distance. The skywave of one pulse can thus contaminate the ground wave of the next pulse in the pulse group. Phase coding ensures that this skywave contamination will always "cancel out" when all the pulses of two consecutive GRIs are averaged together.

Blink coding provides integrity to the received Loran signal. When a signal from a secondary station is out of tolerance and therefore temporarily unsuitable for navigation, or **out-of-tolerance (OOT)**, the affected secondary station will blink; that is, the first two pulses of the affected secondary station are turned off and on in a repeating cycle, 3.6 seconds off and 0.4 seconds on. The receiver detects this condition and displays it to the operator. When the blink indication is received, the operator should not use the affected secondary station. If a station's signal will be temporarily shut down for maintenance, interruption notifications will be promulgated by responsible local authorities. When a secondary station is blinking, the master station will also blink its ninth pulse in a predetermined pattern that identifies the out-of-tolerance secondary or secondaries. If a master station is out of tolerance, all secondaries in the affected chain will blink. If the entire chain is OOT, then the master and all secondaries will blink.

Two other concepts important to the understanding of Loran operation are the **baseline** and **baseline extension**. The geographic line connecting a master to a particular secondary station is defined as the station pair baseline. The baseline is, in other words, that part of a great circle on which lie all the points connecting the two stations. The extension of this line beyond the stations to encompass the points along this great circle not lying between the two stations defines the baseline extension. The optimal region for hyperbolic navigation occurs in the vicinity of the baseline, while the most care must be exercised in the regions near the baseline extension. These concepts are further developed in the next few articles.

2404. Loran Theory of Operation

In Loran navigation, the locus of points having a constant difference in distance between an observer and each of two transmitter stations defines a hyperbola, which is a line of position.

Assuming a constant speed of propagation of electromagnetic radiation in the atmosphere, the time difference in the arrival of electromagnetic radiation from the two transmitter sites is proportional to the distance between each of the transmitting sites, thus creating the hyperbola on the earth's surface. The following equations demonstrate this proportionality between distance and time:

$$\text{Distance} = \text{Velocity} \times \text{Time}$$

or, using algebraic symbols

$$d = v \times t$$

Therefore, if the velocity (v) is constant, the distance between a vessel and each of two transmitting stations will be directly proportional to the time delay detected at the vessel between pulses of electromagnetic radiation transmitted from the two stations.

An example illustrates the concept. As shown in Figure 2404, let us assume that two Loran transmitting stations, a master and a secondary, are located along with an observer in a Cartesian coordinate system whose units are in nautical miles. We assume further that the master station, designated "M", is located at coordinates $(x,y) = (-200,0)$ and the secondary, designated "X," is located at $(x,y) = (+200,0)$. An observer with a receiver capable of detecting electromagnetic radiation is positioned at any point "A" whose coordinates are defined as (x_a,y_a) .

Note that for mathematical convenience, these hyperbola labels have been normalized so that the hyperbola perpendicular to the baseline is labeled zero, with both negative and positive difference values. In actual practice, all Loran TDs are positive.

The Pythagorean theorem can be used to determine the distance between the observer and the master station; similarly, one can obtain the distance between the observer and the secondary station:

$$\text{distance}_{am} = [(x_a + 200)^2 + y_a^2]^{0.5}$$

$$\text{distance}_{ax} = [(x_a - 200)^2 + y_a^2]^{0.5}$$

The difference between these distances (D) is:

$$D = \text{distance}_{am} - \text{distance}_{ax}$$

Substituting,

$$D = [(x_a + 200)^2 + y_a^2]^{0.5} - [(x_a - 200)^2 + y_a^2]^{0.5}$$

With the master and secondary stations in known geographic positions, the only unknowns are the two geographic coordinates of the observer.

Each hyperbolic line of position in Figure 2404 represents the locus of points for which (D) is held constant. For example, if the observer above were located at point A (271.9, 200) then the distance between that observer and the secondary station (the point designated "X" in Figure 2404) would be 212.5 NM. In turn, the observer's distance from the master station would be 512.5 NM. The function D would simply be the difference of the two, or 300 NM. For every other point along the hyperbola passing through A, distance D has a value of 300 NM. Adjacent LOPs indicate where D is 250 NM or 350 NM.

To produce a fix, the observer must obtain a similar hyperbolic line of position generated by another master-secondary pair. Let us say another secondary station "Y" is placed at point (50,500). Mathematically, the observer will then have two equations corresponding to the M-X and M-Y TD pairs:

$$D_1 = [(x_a + 200)^2 + y_a^2]^{0.5} - [(x_a - 200)^2 + y_a^2]^{0.5}$$

$$D_2 = [(x_a + 200)^2 + y_a^2]^{0.5} - [(x_a - 50)^2 + (y_a - 500)^2]^{0.5}$$

Distances D_1 and D_2 are known because the time differences have been measured by the receiver and converted to these distances. The two remaining unknowns, x_a and y_a , may then be solved.

The above example is expressed in terms of distance in

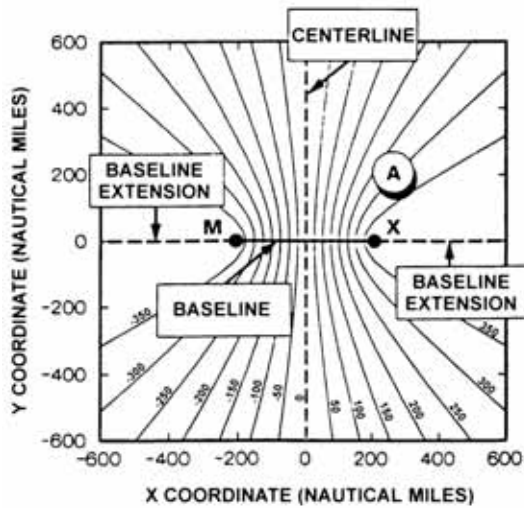

Figure 2404. Depiction of Loran LOP's.

nautical miles. Because the navigator uses TDs to perform Loran hyperbolic navigation, let us rework the example for the M-X TD pair in terms of time rather than distance, adding timing details specific to Loran. Let us assume that electromagnetic radiation travels at the speed of light (one nautical mile traveled in 6.18 μsec). The distance from master station M to point A was 512.5 NM. From the relationship just defined between distance and time, it would take a signal $(6.18 \mu\text{sec}/\text{NM}) \times 512.5 \text{ NM} = 3,167 \mu\text{sec}$ to travel from the master station to the observer at point A. At the arrival of this signal, the observer's Loran receiver would start the TD measurement. Recall from the general discussion above that a secondary station transmits after an emission delay equal to the sum of the baseline travel time and the secondary coding delay. In this example, the master and the secondary are 400 NM apart; therefore, the baseline travel time is $(6.18 \mu\text{sec}/\text{NM}) \times 400 \text{ NM} = 2,472 \mu\text{sec}$. Assuming a secondary coding delay of 11,000 μsec , the secondary station in this example would transmit

$(2,472 + 11,000) \mu\text{sec}$ or 13,472 μsec after the master station. The secondary signal then propagates over a distance 212.5 NM to reach point A, taking $(6.18 \mu\text{sec}/\text{NM}) \times 212.5 \text{ NM} = 1,313 \mu\text{sec}$ to do so. Therefore, the total time from transmission of the master signal to the reception of the secondary signal by the observer at point A is $(13,472 + 1,313) \mu\text{sec} = 14,785 \mu\text{sec}$.

Recall, however, that the Loran receiver measures the time delay between reception of the master signal and reception of the secondary signal. Therefore, the time quantity above must be corrected by subtracting the amount of time required for the signal to travel from the master transmitter to the observer at point A. This amount of time was 3,167 μsec . Therefore, the TD observed at point A in this hypothetical example would be $(14,785 - 3,167) \mu\text{sec}$ or 11,618 μsec . Once again, this time delay is a function of the simultaneous differences in distance between the observer and the two transmitting stations, and it gives rise to a hyperbolic line of position which can be crossed with another LOP to fix the observer's position.

2405. Allowances for Non-Uniform Propagation Rates

The initial calculations above assumed the speed of light in free space; however, the actual speed at which electromagnetic radiation propagates on earth is reduced both by the atmosphere through which it travels and by the conductive surfaces—sea and land—over which it passes. The specified accuracy needed from Loran therefore requires three corrections to the propagation speed of the signal.

The reduction in propagation speed caused by the atmosphere is represented by the first correction term: the **Primary Phase Factor (PF)**. Similarly, a **Secondary Phase Factor (SF)** accounts for the reduced propagation speed caused by traveling over seawater. These two corrections are transparent to the operator because they are uniformly incorporated into all calculations represented on charts and in Loran receivers.

Because land surfaces have lower conductivity than seawater, the propagation speed of the Loran signal passing over land is further reduced as compared to the signal passing over seawater. A third and final correction, the **Additional Secondary Phase Factor (ASF)**, accounts for the delay caused by the land conductivity when converting time delays to distances and then to geographic coordinates. Depending on the mariner's location, signals from some Loran transmitters may have traveled hundreds of miles over land and must be corrected to account for this non-seawater portion of the signal path. Of the three corrections mentioned in this section, this is the most complex and the most important one to understand, and is accordingly treated in detail in Section 2410.

LORAN ACCURACY

2406. Defining Accuracy

Specifications of Loran and other radionavigation systems typically refer to three types of accuracy: **absolute**, **repeatable** and **relative**.

Absolute accuracy, also termed predictable or geodetic accuracy, is the accuracy of a position with respect to the geographic coordinates of the earth. For example, if the navigator plots a position based on the Loran latitude and longitude (or based on Loran TDs) the difference between the Loran position and the actual position is a measure of the system's absolute accuracy.

Repeatable accuracy is the accuracy with which the navigator can return to a position whose coordinates have been measured previously with the same navigational system. For example, suppose a navigator were to travel to a buoy and note the TDs at that position. Later, suppose the navigator, wanting to return to the buoy, returns to the previously measured TDs. The resulting position difference between the vessel and the buoy is a measure of the system's repeatable accuracy.

Relative accuracy is the accuracy with which a user can measure position relative to that of another user of the same navigation system at the same time. If one vessel were to travel to the TDs determined by another vessel, the difference in position between the two vessels would be a measure of the system's relative accuracy.

The distinction between absolute and repeatable accuracy is the most important one to understand. With the correct application of ASFs and within the **coverage area** defined for each chain, the absolute accuracy of the Loran system varies from between 0.1 and 0.25 nautical miles. However, the repeatable accuracy of the system is much better, typically between 18 and 90 meters (approximately 60 to 300 feet) depending on one's location in the coverage area. If the navigator has been to an area previously and noted the TDs corresponding to different navigational aids (e.g., a buoy marking a harbor entrance), the high repeatable accuracy of the system enables location of the buoy in adverse weather. Similarly, selected TD data for various harbor navigational aids and other locations of interest have been collected and recorded and is generally commercially available. This information provides an excellent backup navigational source to conventional harbor approach navigation.

2407. Limitations to Loran Accuracy

There are limits on the accuracy of any navigational system, and Loran is no exception. Several factors that contribute to limiting the accuracy of Loran as a navigational aid are listed in Table 2407 and are briefly discussed in this section. Even though all these factors except operator error are included in the published accuracy of Loran, the mari-

ner's aim should be to have a working knowledge of each one and minimize any that are under their control so as to obtain the best possible accuracy.

The geometry of LOPs used in a Loran fix is of prime importance to the mariner. Because understanding of this factor is so critical to proper Loran operation, the effects of crossing angles and gradients are discussed in detail in the Section 2408. The remaining factors are briefly explained as follows.

The age of the North American (i.e. US and Canadian) Loran transmitting equipment varies from station to station. When some older types of equipment are switched from standby to active and vice versa, a slight timing shift as large as tens of nanoseconds may be seen. This is so small that it is undetectable by most marine receivers, but since all errors accumulate, it should be understood as part of the Loran "error budget."

The effects of actions to control chain timing are similar. The timing of each station in a chain is controlled based on data received at the primary system area monitor site. Signal timing errors are kept as near to zero as possible at the primary site, making the absolute accuracy of Loran generally the best in the vicinity of the primary site. Whenever, due to equipment casualty or to accomplish system maintenance, the control station shifts to the secondary system area monitor site, slight timing shifts may be introduced in parts of the coverage area.

Atmospheric noise, generally caused by lightning, reduces the **signal-to-noise ratio (SNR)** available at the receiver. This in turn degrades accuracy of the LOP. Man-made noise has a similar effect on accuracy. In rare cases, a man-made noise source whose carrier signal frequency or harmonics are near 100 kHz (such as the constant carrier control signals commonly used on high-tension power lines) may also interfere with lock-on and tracking of a Loran receiver. In general, Loran stations that are the closest to the user will have the highest SNR and will produce LOPs with the lowest errors. Geometry, however, remains a key factor in producing a good fix from combined LOPs. Therefore, the best LOPs for a fix may not all be from the very nearest stations.

The user should also be aware that the propagation speed of Loran changes with time as well. Temporal changes may be seasonal, due to snow cover or changing groundwater levels, or diurnal, due to atmospheric and surface changes from day to night. Seasonal changes may be as large as 1 μ sec and diurnal changes as large as 0.2 μ sec, but these vary with location and chain being used. Passing cold weather fronts may have temporary effects as well.

Disturbances on the sun's surface, most notably solar flares, disturb the earth's atmosphere as well. These Sudden Ionospheric Disturbances (SIDs) increase attenuation of radio waves and thus disturb Loran signals and reduce SNR. Such a disturbance may interfere with Loran reception for

periods of hours or even longer.

The factors above all relate to the propagated signal before it reaches the mariner. The remaining factors discussed

below address the accuracy with which the mariner receives and interprets the signal.

Factor	Has effect on	
	Absolute Accuracy	Repeatable Accuracy
Crossing angles and gradients of the Loran LOPs	Yes	Yes
Stability of the transmitted signal (e.g., transmitter effect)	Yes	Yes
Loran chain control parameters (e.g., how closely actual ED is maintained to published ED, which system area monitor is being used, etc.)	Yes	Yes
Atmospheric and man-made ambient electronic noise	Yes	Yes
Factors with temporal variations in signal propagation speed (e.g., weather, seasonal effects, diurnal variations, etc.)	Yes	Yes
Sudden ionospheric disturbances	Yes	Yes
Receiver quality and sensitivity	Yes	Yes
Shipboard electric noise	Yes	Yes
Accuracy with which LOPs are printed on nautical charts	Yes	No
Accuracy of receiver's computer algorithms for coordinate conversion	Yes	No
Operator error	Yes	Yes

Table 2407. Selected Factors that Limit Loran Accuracy.

Receivers vary in precision, quality and sophistication. Some receivers display TDs to the nearest 0.1 μ sec; others to 0.01 μ sec. Internal processing also varies, whether in the analog "front end" or the digital computer algorithms that use the processed analog signal. By referencing the user manual, the mariner may gain an appreciation for the advantages and limitations of the particular model available, and may adjust operator settings to maximize performance.

The best receiver available may be hindered by a poor installation. Similarly, electronic noise produced by electric motors, other electronic equipment or even fluorescent lighting may hinder the performance of a Loran receiver if the noise source is close to the receive antenna. The mariner should consult documentation supplied with the receiver for proper installation. Generally, proper installation and placement of the of the receive antenna will mitigate these problems. In some cases, contacting the manufacturer or obtaining professional installation assistance may be appropriate.

The raw TDs obtained by the receiver must be corrected with ASFs and then translated to position. Whether the receiver performs this entire process or the mariner assists by translating TDs to position manually using a Loran overprinted chart, published accuracies take into account the small errors involved in this conversion process.

Finally, as in all endeavors, operator error when using Loran is always possible. This can be minimized with alertness, knowledge and practice.

2408. The Effects of Crossing Angles and Gradients

The hyperbolic nature of Loran requires the operator

to pay special attention to the geometry of the fix, specifically to crossing angles and gradients, and to the possibility of fix ambiguity. We begin with crossing angles.

As discussed above, the TDs from any given master-

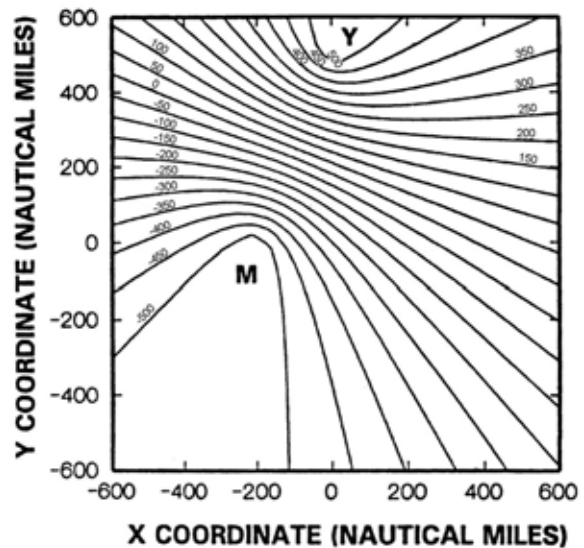

Figure 2408a. A family of hyperbolic lines generated by Loran signals.

secondary pair form a family of hyperbolas. Each hyperbola in this family can be considered a line of position; the vessel must be somewhere along that locus of points which forms the hyperbola. A typical family of hyperbolas is shown in Figure 2408a.

Now, suppose the hyperbolic family from the Master-

Xray station pair shown in Figure 2404 were superimposed

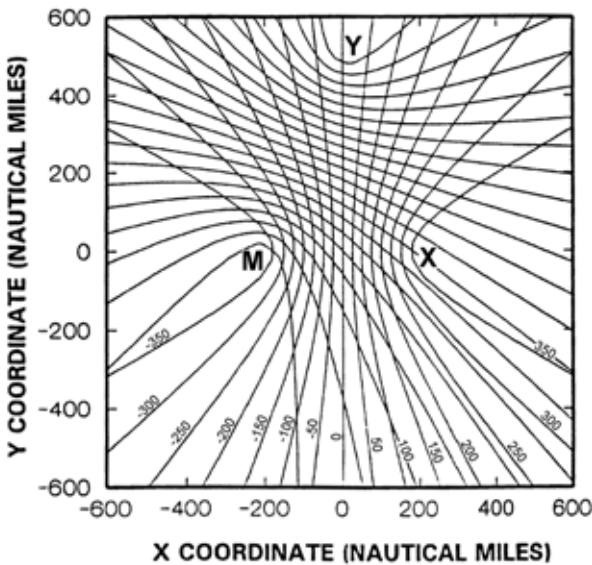

Figure 2408b. A hyperbolic lattice formed by station pairs M-X and M-Y.

upon the family shown in Figure 2408a. The results would be the hyperbolic lattice shown in Figure 2408b.

As has been noted, Loran LOPs for various chains and secondaries are printed on nautical charts. Each of the sets of LOPs is given a separate color and is denoted by a characteristic set of symbols. For example, an LOP might be designated 9960-X-25750. The designation is read as follows: the chain GRI designator is 9960, the TD is for the Master-Xray pair (M-X), and the time difference along this LOP is 25750 μ sec. The chart shows only a limited number of LOPs to reduce clutter on the chart. Therefore, if the observed time delay falls between two charted LOPs, interpolation between them is required to obtain the precise LOP. After having interpolated (if necessary) between two TD measurements and plotted the resulting LOPs on the chart, the navigator marks the intersection of the LOPs and labels that intersection as the Loran fix. Note also in Figure 2408b the various angles at which the hyperbolas cross each other.

Figure 2408c shows graphically how error magnitude varies as a function of crossing angle. Assume that LOP 1 is known to contain no error, while LOP 2 has an uncertainty as shown. As the crossing angle (i.e., the angle of intersection of the two LOPs) approaches 90°, range of possible positions along LOP 1 (i.e., the position uncertainty or fix error) approaches a minimum; conversely, as the crossing angle decreases, the position uncertainty increases; the line defining the range of uncertainty grows longer. This illustration demonstrates the desirability of choosing LOPs for which the crossing angle is as close to 90° as possible.

The relationship between crossing angle and fix uncer-

tainty can be expressed mathematically:

$$\sin(x) = \frac{\text{LOP error}}{\text{fix uncertainty}}$$

where x is the crossing angle.

Rearranging algebraically,

$$\text{fix uncertainty} = \frac{\text{LOP error}}{\sin(x)}$$

Assuming that LOP error is constant, then position uncertainty is inversely proportional to the sine of the crossing angle. As the crossing angle increases from 0° to 90°, the sine of the crossing angle increases from 0 to 1. Therefore, the error is at a minimum when the crossing angle is 90°, and increases thereafter as the crossing angle decreases.

Understanding and proper use of TD gradients are also important to the navigator. The gradient is defined as the rate of change of distance with respect to TD. Put another way, this quantity is the ratio of the spacing between adjacent Loran TDs (usually expressed in feet or meters) and the difference in microseconds between these adjacent LOPs. For example, if at a particular location two printed TD lines differ by 20 μ sec and are 6 NM apart, the gradient is.

$$\text{Gradient} = \frac{6\text{NM} \times 6076\text{ft/NM}}{20\mu\text{sec}} = 1822.8 \text{ ft}/\mu\text{sec}$$

The smaller the gradient, the smaller the distance error that results from any TD error. Thus, the best accuracy from Loran is obtained by using TDs whose gradient is the smallest possible (i.e. the hyperbolic lines are closest together). This occurs along the baseline. Gradients are much larger (i.e. hyperbolic lines are farther apart) in the vicinity of the baseline extension. Therefore, the user should select TDs having the smallest possible gradients.

Another Loran effect that can lead to navigational error in the vicinity of the baseline extension is fix ambiguity. Fix ambiguity results when one Loran LOP crosses another LOP in two separate places. Near the baseline extension, the “ends” of a hyperbola can wrap around so that they cross another LOP twice, once along the baseline, and again along the baseline extension. A third LOP would resolve the ambiguity.

Most Loran receivers are equipped with an ambiguity alarm to alert the navigator to this occurrence. However, both fix ambiguity and large gradients necessitate that the navigator avoid using a master-secondary pair when operating in the vicinity of that pair’s baseline extension.

2409. Coverage Areas

The 0.25 NM absolute accuracy specified for Loran is valid within each chain's coverage area. This area,

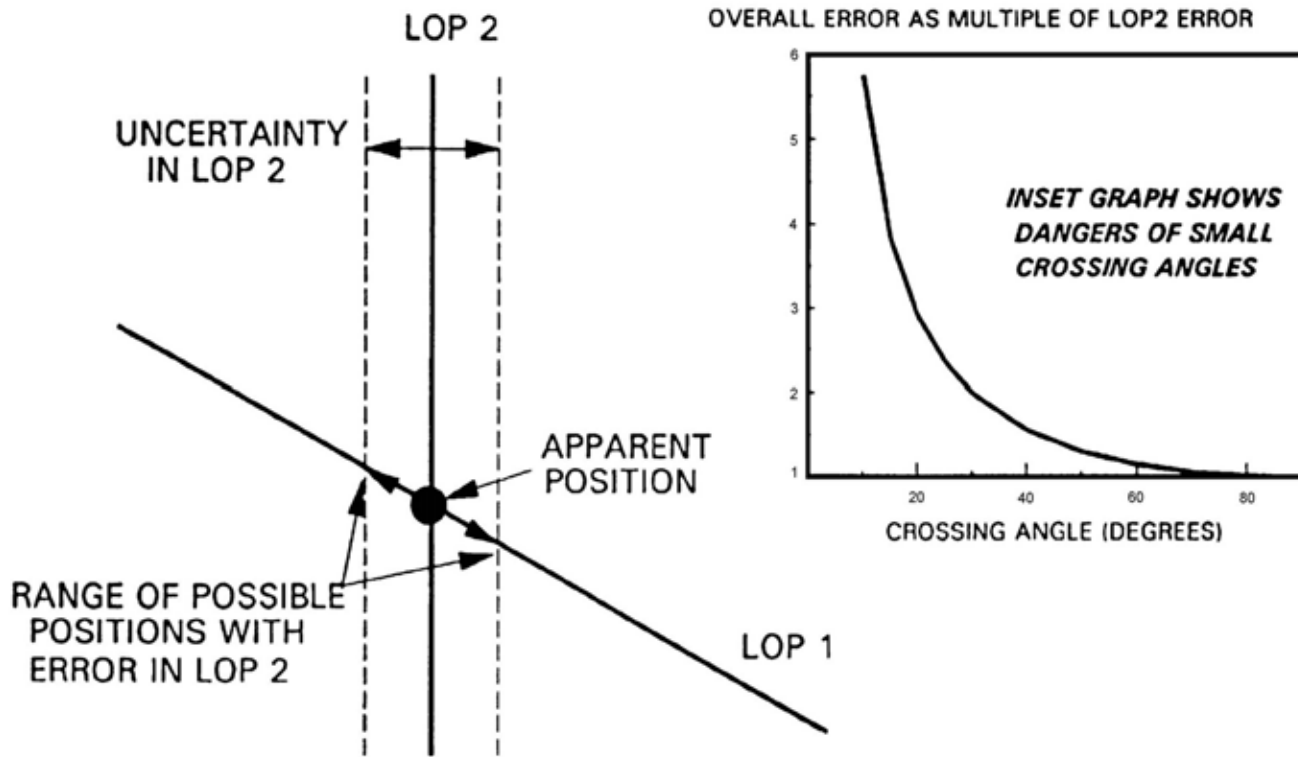

Figure 2408c. Error in Loran LOP's is magnified if the crossing angle is less than 90°.

whose limits define the maximum range of Loran for a particular chain, is the region in which both accuracy and SNR criteria are met. The National Oceanographic and Atmospheric Administration (NOAA) has generally followed these coverage area limits when selecting where to print particular Loran TD lines on Loran overprinted charts.

One caveat to remember when considering coverage areas is that the 0.25 NM accuracy criteria is modified inside the coverage area in the vicinity of the coastline due to ASF effects. The following section describes this more fully.

2410. Understanding Additional Secondary Factors (ASF's)

Mathematically, calculating the reduction in propagation speed of an electromagnetic signal passing over a land surface of known conductivity is relatively straightforward. In practice, however, determining this Loran ASF correction accurately for use in the real world can be complex.

There are at least four reasons for this complexity. First, the conductivity of ground varies from region to region, so the correction to be applied is different for every signal path. Moreover, ground conductivity data may not take into account all the minor variations within each region. Second, methods used to compute ASFs vary. ASFs

can be determined from either a mathematical model based on known approximate ground conductivities, or from empirical time delay measurements in various locations, or a combination of both. Methods incorporating empirical measurements tend to yield more accurate results. One receiver manufacturer may not use exactly the same correction method as another, and neither may use exactly the same method as those incorporated into time differences printed on a particular nautical chart. While such differences are minor, a user unaware of these differences may not obtain the best accuracy possible from Loran. Third, relatively large local variations in ASF variations may not be fully accounted for in the ASF models applied to the coverage area. Over the years, even empirically measured ASFs may change slightly in these areas with the addition of buildings, bridges and other structures to coastal areas. Fourth and finally, ASFs vary seasonally with changes in groundwater levels, snow pack depths and similar factors. However, ASFs are generally consistent year-on-year for a given area.

Designers of the Loran system, including Loran receiver manufacturers, have expended a great deal of effort to include ASFs in error calculations and to minimize these effects. Indeed, inaccuracies in ASF modeling are accounted for in published accuracy specifications for Loran. What then does the marine navigator need to know about ASFs beyond this? To obtain the 0.25 NM absolute accuracy advertised for Loran, the answer is clear. One must know

where in the coverage area ASFs affect published accuracies, and one must know when ASFs are being incorporated, both in the receiver and on any chart in use.

With respect to where ASFs affect published accuracies, one must remember that local variations in the vicinity of the coastline are the most unpredictable of all ASF related effects because that is where rapid transitions from water to land occur. As a result, even though fixes determined by Loran may satisfy the 0.25 NM accuracy specification in these areas, such accuracy is not “guaranteed” for Loran within 10 NM of the coast. Users should also avoid relying solely on the lattice of Loran TDs in inshore areas.

With respect to when ASFs are being applied, one should realize that the default mode in most receivers combines ASFs with raw TD measurements. This is because the inclusion of ASFs is required to meet the 0.25 NM accuracy criteria. The navigator should verify which mode the receiver is in, and ensure the mode is not changed unknowingly.

The key point to remember there is that the “ASF included” and “ASF not included” modes must not be mixed. In other words, the receiver and any chart in use must handle ASFs in the same manner. If the receiver includes them, any chart in use must also include them. If operating on a chart that does not include ASFs-Loran coverage areas in another part of the world, for example—the receiver must be set to the same mode. If the navigator desires to correct ASFs manually, tables for U.S. Loran chains may be used although are not currently directly available from the U.S. Government. These documents also provide a fuller explanation of manual ASF corrections. When viewing ASF tables, remember that although the ASF correction for a single signal is always positive (indicating that the signal is always slowed and never speeded by its passage over land), the ASF correction for a time difference may be negative because two signal delays are included in the computation.

The U.S. Government does not guarantee the accuracy of ASF corrections incorporated into Loran receivers by their respective manufacturers. The prudent navigator will regularly check Loran TDs against charted LOPs when in a known position, and will compare Loran latitude and longitude readouts against other sources of position information. Ensuring the proper configuration and operation of the Loran receiver remains the navigator’s responsibility.

Up to this point, our discussion has largely focused on correctly understanding and using Loran in order to obtain published accuracies. In some portions of the coverage areas, accuracy levels actually obtainable may be significantly better than these minimum published values. The following articles discuss practical techniques for maximizing the absolute, repeatable and relative accuracy of Loran.

2411. Maximizing Loran’s Absolute Accuracy

Obtaining the best possible absolute accuracy from Lo-

ran rests primarily on the navigator’s selection of TDs, particularly taking into account geometry, SNR and proximity to the baseline and baseline extension. As a vessel transits the coverage area, these factors gradually change and, except for SNR, are not visible on the display panel of the Loran receiver. Most receivers track an entire chain and some track multiple chains simultaneously, but the majority of installed marine receivers still use only two TDs to produce a latitude and longitude. Some receivers monitor these factors and may automatically select the best pair. The best way for the navigator, however, to monitor these factors is by referring to a Loran overprinted chart, even if not actually plotting fixes on it. The alert navigator will frequently reevaluate the selection of TDs during a transit and make adjustments as necessary.

Beyond this advice, two additional considerations may help the navigator maximize absolute accuracy. The first is the realization that Loran TD error is not evenly distributed over the coverage area. Besides the effects of transmitter station location on geometry and fix error, the locations of the primary and secondary monitor sites also have a discernible effect on TD error in the coverage area. As ASFs change daily and seasonally, the Loran control stations continually adjust the emission delay of each secondary station to keep it statistically at its nominal value as observed at the primary monitor site. What this means is that, on average, the Loran TD is more stable and more accurate in the absolute sense in the vicinity of the primary monitor site. The primary system area monitor for stations 9960-M, 9960-X and 9960-Y was placed at the entrance to New York harbor at Sandy Hook, New Jersey for just this reason. A switch by the control station to the secondary monitor site will shift the error distribution slightly within the coverage area, reducing it near the secondary site and slightly increasing it elsewhere.

The second consideration in maximizing absolute accuracy is that most Loran receivers may be manually calibrated using a feature variously called “bias,” “offset,” “homeport” or a similar term. When in homeport or another known location, the known latitude and longitude (or in some cases, the difference between the current Loran display and the known values) is entered into the receiver. This forces the receiver’s position error to be zero at that particular point and time.

The limitation of this technique is that this correction becomes less accurate with the passage of time and with increasing distance away from the point used. Most published sources indicate the technique to be of value out to a distance of 10 to 100 miles of the point where the calibration was performed. This correction does not take into account local distortions of the Loran grid due to bridges, power lines or other such man-made structures. The navigator should evaluate experimentally the effectiveness of this technique in good weather conditions before relying on it for navigation at other times. The bias should also be adjusted regularly to account for seasonal Loran variations;

using the same value throughout the year is not the most effective application of this technique. Also, entering an offset into a Loran receiver alters the apparent location of waypoints stored prior to establishing this correction.

Finally, receivers vary in how this feature is implemented. Some receivers save the offset when the receiver is turned off; others zero the correction when the receiver is turned on. Some receivers replace the internal ASF value with the offset, while others add it to the internal ASF values. Refer to the owner's manual for the receiver in use.

2412. Maximizing Loran's Repeatable Accuracy

Many users consider the high repeatable accuracy of Loran its most important characteristic. To obtain the best repeatable accuracy consistently, the navigator should use measured TDs rather than latitude and longitude values supplied by the receiver.

The reason for this lies in the ASF conversion process. Recall that Loran receivers use ASFs to correct TDs. Recall also that the ASFs are a function of the terrain over which the signal must pass to reach the receiver. Therefore, the ASFs for one station pair are different from the ASFs for another station pair because the signals from the different pairs must travel over different terrain to reach the receiver.

This consideration matters because a Loran receiver may not always use the same pairs of TDs to calculate a fix. Suppose a navigator marks the position of a channel buoy by recording its latitude and longitude using the TD pair selected automatically by the Loran receiver. If, on the return trip, the receiver is using a different TD pair, the latitude and longitude readings for the exact same buoy would be slightly different because the new TD pair would be using a different ASF value. By using previously-measured TDs and not previously-measured latitudes and longitudes, this ASF-introduced error is avoided. The navigator should also record the values of all secondary TDs at the waypoint and

not just the ones used by the receiver at the time. When returning to the waypoint, other TDs will be available even if the previously used TD pair is not. Recording the time and date the waypoint is stored will also help evaluate the cyclical seasonal and diurnal variations that may have since occurred.

2413. Maximizing Loran's Relative Accuracy

The classical application of relative accuracy involves two users finding the same point on the earth's surface at the same time using the same navigation system. The maximum relative Loran accuracy would be theoretically achieved by identical receivers, configured and installed identically on identical vessels, tracking the same TDs. In practice, the two most important factors are tracking the same TDs and ensuring that ASFs are being treated consistently between the two receivers. By attending to these, the navigator should obtain relative accuracy close to the theoretical maximum.

Another application of relative accuracy is the current practice of converting old Loran TDs into latitude and longitude for use with GPS and DGPS receivers. Several commercial firms sell software applications that perform this tedious task. One key question posed by these programs is whether or not the Loran TDs include ASFs. The difficulty in answering this question depends on how the Loran TDs were obtained, and of course an understanding of ASFs. If in doubt, the navigator can perform the conversion once by specifying "with" ASFs and once "without," and then carefully choosing which is the valid one, assisted by direct observation underway if needed.

To round out the discussion of Loran, the following section briefly describes present and possible future uses for this system beyond the well-known hyperbolic navigation mode.

NON-HYPERBOLIC USES OF LORAN-C

2414. Precise Timing with Loran-C

Because Loran is fundamentally a **precise timing system**, a significant segment of the user community uses Loran for the propagation of Coordinated Universal Time (UTC). The accessibility of UTC at any desired location enables such applications as the synchronization of telephone and data networks. Because the timing of each secondary station is relative to the master, its timing accuracy derives from that of the master.

The start of each Loran station's GRI periodically coincides with the start of the UTC second. This is termed the Time of Coincidence (TOC). Because one Loran station is sufficient to provide an absolute timing reference, timing receivers do not typically rely on the hyperbolic mode or use TDs per se.

A noteworthy feature of Loran is that each transmitter station has an independent timing reference consisting of one or more Primary Reference Standards. Timing equipment at the transmitter stations constantly compares these signals and adjusts to minimize oscillator drift. The end result is a nationwide system with a large ensemble of independent timing sources. This strengthens the U.S. technology infrastructure. As another cross-check of Loran time, daily comparisons are made with UTC, as disseminated via GPS.

2415. Loran-C Time of Arrival (TOA) Mode

With the advent of the powerful digital processors and compact precise oscillators now embedded in user receivers, technical limitations that dictated Loran's hyperbolic

architecture decades ago have been overcome. A receiver can now predict in real time the exact point in time a Loran station will transmit its signal, as well as the exact time the signal will be received at any assumed position.

An alternate receiver architecture that takes advantage of these capabilities uses Loran **Time of Arrival (TOA)** measurement, which are measured relative to UTC rather than to an arbitrary master station's transmission. A receiver operating in TOA mode can locate and track all Loran signals in view, prompting the descriptor "all in view" for this type of receiver. This architecture steps beyond the limitations of using only one Loran chain at a time. As a result, system availability can be improved across all the overlapping coverage areas. Coupled with advanced **Receiver Autonomous Integrity Monitor (RAIM)** algorithms, this architecture can also add an additional layer of integrity at the user level, independent of Loran blink.

2416. Loran-C in an Integrated Navigation System

An exponential worldwide increase in reliance on electronic navigation systems, most notably GPS, for positioning and timing has fueled a drive for more robust systems immune from accidental or intentional interference. Even a short outage of GPS, for example, would likely have severe safety and economic consequences for users.

In this environment, integrated navigation systems are attractive options as robust sources of position and time. The ideal **integrated navigation system (INS)** can tolerate the degradation or failure of any component system without degradation as a whole.

Loran offers several advantages to an integrated system based on GPS. Although Loran relies on radio propagation and is thus similarly vulnerable to large-scale atmospheric events such as ionospheric disturbances, at 100 kHz it occupies a very different portion of the spectrum

than the 1.2 GHz to 1.6 GHz band used by GPS. Loran is a high-power system whose low frequency often uses a very large antenna for efficient propagation. Therefore, jamming Loran over a broad area is much more difficult than jamming GPS over the same area. Loran signals are present in urban and natural canyons and under foliage, where GPS signals may be partially or completely blocked. Loran's independent timing source also provides an additional degree of robustness to an integrated system. In short, the circumstances that cause failure or degradation of Loran are very different from those that cause failure or degradation of GPS. When the absolute accuracy of Loran is continually calibrated by GPS, the repeatable accuracy of Loran could ensure near-GPS performance of an integrated system in several possible navigation and timing scenarios, for periods of several hours to a few days after a total loss of GPS, depending upon the capability of the INS.

2417. Loran-C as a Data Transfer Channel

Low data rate transmission using Loran signals began in the 1960s with a system known as Clarinet Pilgrim (CP). CP was followed in the 1970s with a similar system termed "Two-Pulse Communications (TPC)". The two primary uses of this capability were Loran chain control and backup military communications. In all cases, the data superimposed on the Loran signal were transparent to the users, who were nearly universally unaware of this dual use.

In the late 1990s, the Northwest European Loran System (NELS) implemented a pulse-position modulation scheme termed Eurofix to provide differential GPS corrections via the Loran signal to certain areas in western and northern Europe. Eurofix successfully incorporated sophisticated data communications techniques to broadcast GPS corrections in real time while allowing traditional Loran users to operate without interruption.

ENHANCED LORAN (E-LORAN)

2418. eLoran Improvements over Loran-C

As of 2016, eLoran is not available for navigational use anywhere in the world.

While eLoran is currently only broadcast in North America from the former USCG Loran Support Unit transmitting site in Wildwood, New Jersey, the system specifications have been developed and tested. The information presented here comes from various sources involved in the development of eLoran and gives an overview to the enhanced capabilities that eLoran will provide.

eLoran was designed such that new capabilities were added to increase system performance while retaining all of the previous hyperbolic navigation characteristics of Loran-C (Helwig, Offermans, Stout, & Schue, 2011). Any Loran-C receiver can be used with an eLoran transmitting

station although Loran-C receivers cannot take advantage of the new capabilities built into eLoran.

eLoran was designed to have improved accuracy, availability, continuity, and integrity over Loran-C (FAA, 2004). eLoran will be a stratum-1 source of UTC time within 50ns such that clocks can be calibrated using eLoran (Helwig, 2011). When fully deployed, it would be the most accurate broadcast source of UTC time independent of a Global Navigation Satellite System (GNSS) such as GPS.

eLoran will be more accurate than Loran-C with a designed position accuracy within 8-20 meters provided the receiver is set up properly and any additional secondary factor corrections are applied (International Loran Association 2007) (Helwig, 2011). eLoran will be able to achieve an increased accuracy over Loran-C because the transmitted signal has tighter tolerances between the GRIs, pulses,

and zero-crossings which result in less error in the transmitted signal (International Loran Association 2007) (Helwig, 2011). eLoran also contains a data channel which transmits messages indicating error corrections and precise timing information (International Loran Association 2007) (Helwig, 2011). eLoran's increased position and timing accuracy over Loran-C will allow it to meet modern Maritime Harbor Entrance and Approach (HEA) and Aviation En Route and Non-Precision Approach (RNA) requirements (International Loran Association 2007) (Helwig, 2011).

eLoran also includes one or more Loran Data Channels (LDC), which use various means of modulation to transmit messages (Schue et al., 2000). Current LDC modulation schemes include either the 3-state Eurofix approach or the 9th pulse modulation approach, or both (Helwig, 2011). These messages are very short in nature because the LDC has a low data throughput (slow rate of message transmission). The LDC continuously transmits a series of messages when the system broadcasts (Schue et al., 2000) (Helwig, 2011).

Each pulse position modulation technique accomplishes transmission of a full message within 3s, though the internal structure of each message is slightly different. Alternative modulation techniques provide higher data rates (Schue et al., 2000). The Eurofix approach independently modulates each one of the last six pulses of the GRI by $\pm 1\mu\text{s}$. Many possible configurations (combinations of $-1\mu\text{s}$, 0, or $+1\mu\text{s}$ shifted pulse) of the last six pulses can be created using this modulation technique; 128 are used for encoding messages. Each sixth-pulse modulation represents seven bits of information. Every message is 210 bits long, containing 30 seven-bit parts. One complete message takes 30 GRIs to receive and a new message begins broadcasting every 30 GRIs. A full message would take a maximum of 3s (assuming a GRI of 9999) to receive using the Eurofix method (Offermans, Helwig, Van Willigen, 1996) (Offermans, Helwig, Van Willigen, 1997).

The 9th pulse modulation technique adds an extra pulse approximately $1000\mu\text{s}$ after the 8th pulse of the Master station (which is also $1000\mu\text{s}$ before the final pulse in the master station) and an extra (9th) pulse in the secondary station approximately $1000\mu\text{s}$ after the 8th secondary pulse (making the modulated 9th pulse the final pulse in the secondary GRI). 32 possible states (states 0 through state 31) are defined by moving the position of this pulse in each GRI. The zero-state is defined when this pulse occurs exactly $1000\mu\text{s}$ after the 8th pulse. The 31 remaining symbols are positioned in the GRI using the formula: $D_x \mu = 1.25 \bmod [x, 8] + 50.625 \text{ floor}(x/8)$ where "x" is the possible state (0,31) and D_x is the pulse's time-offset from the zero-state position in the GRI. A receiver would obtain the offset distance of the 9th pulse and use the inverse of the above formula to determine message state. Each GRI can carry 5-bits of information and each 9th pulse modulated message is 120-bits long; so an entire message is transmitted over 24 GRIs. A full message would take a maximum

of 2.4s (assuming a GRI of 9999) to receive using the 9th pulse modulation method (Peterson, Dykstra, Lown & Shmihluk 2006).

A standard eLoran receiver should have the capability of reading messages from the LDC encoded with any type of standardized LDC technique. The message types will be standardized and repeat at regular intervals. When operational, eLoran will be capable of transmitting the following message types and additional message types may be defined in the future (The Radio Technical Commission for Maritime Services 2008) (International Loran Association 2007) (Dykstra & Peterson, 2006) (Helwig, 2011):

- ASF corrections.
- Almanac information containing station specific information such as: station position, station name and station status (replacing Loran blink codes).
- UTC Time of Day expressed as number of seconds since the Loran epoch of 0h0m0s-01 JAN 1958. The number of seconds from the Loran epoch to the time of transmission of the message can be calculated as: $T = 24(GRI)(MEC) + ED$ where MEC is the Message-Epoch-Count which is the number of 24-GRI intervals since the Loran epoch.
- Various Government-Use only messages.

The source of timing for the transmission of eLoran pulses is independent of monitor sites and control centers; the eLoran signals are synchronized to an identifiable, independent UTC source at each site (Helwig, 2011). All time of transmissions for both the master and secondary stations are determined using the independent clocks at each station synchronized to UTC so that a user can obtain/calculate timing information from the strongest signal available instead of just needing the master station fix (The Radio Technical Commission for Maritime Services 2008). The synchronization of all stations with an independent UTC time source allows for greater position accuracy.

eLoran pulses are synchronized independent of any GNSS system using a clock at each transmitter site (Offermans, et al. 2013). One can obtain current UTC time by reading the time of day message from the LDC. Another method of calculating the UTC time involves knowing the receiver's position and ASF corrections (Offermans, Johannessen, Schue, Hirschauer & Powers, 2013). An eLoran receiver measures the time of arrival (the time when a pulse is received). Knowing the receiver's position along with some ASF corrections, one can obtain a synchronized UTC time of transmission (Offermans, et al. 2013) (Helwig, 2011). Since each eLoran transmission is locked to UTC time and each transmitter is an independent source of UTC time, then UTC time may be obtained accurately from any eLoran transmitting station fix.

2419. eLoran Definition Document

The Enhanced Loran (eLoran) Definition Document

was developed in 2006 at the United States Coast Guard Navigation Center by an international team of authors and was published by the ILA in 2007.

The document provides an overview, background and introduction to eLoran along with a detailed description of the eLoran system (eLoran signal, transmitting stations, control centers, monitoring & reference stations and user equipment). The document includes a description of the maritime application for eLoran along with a broader overall service provision for the system. See the following link for access to the document:



Figure 2419. Enhance Loran Definition Document (2007).
<http://www.loran.org/news/eLoran%20Definition%20Document%200%201%20Released.pdf>

2420. References

- Dykstra, K., Peterson, B., (2006). Loran data channel: Progress to date and future plans. *35th Annual Convention and Technical Symposium of the International Loran Association*. Groton, CT.
- Helwig, A., Offermans, G., Stout C., & Schue, C., (2011). eLoran system definition and signal specification tutorial. *40th International Loran Association Conference*. Busan.
- International Loran Association (ILA), 2007. *Enhanced Loran (eLoran) Definition*.
- Offermans, G., Helwig, A., & Van Willigen, D., (1996). The Eurofix datalink concept: Reliable data transmission using Loran-C. *Proceedings of the 25th Annual Technical Meeting of the International Loran Association*, San Diego, CA.
- Offermans, G., Helwig, A., & Van Willigen, D., (1997). Eurofix DGPS Service through the Sylt Loran-C transmitter: Static and dynamic test results. *Proceedings of the 26th Annual Technical Meeting of the International Loran Association*, Ottawa, Canada.
- Offermans, G., Johannessen, E., Schue, C., Hirschauer, J., & Powers, E., (2013). UTC synchronization and stratum-1 frequency recovery using eLoran: The alternate basket for your eggs. *45th Annual Precise Time and Time Interval Systems and Applications Meeting. The Institute of Navigation*. Bellevue, WA.
- Peterson, B., Dykstra, K., Lown, D., & Shmilhuk, K., (2006, vers 1.3). Loran Data Channel Communications Using 9th Pulse Modulation.
- Schue, C., Peterson, B., et al, (2000). Enhanced Loran-C Data Channel Project, *German Institute of Navigation (DGON) Symposium and Technical Conference*, Bonn, Germany.
- Schue, C., Peterson, B., Celano, T., (2004). Low Cost Digitally Enhanced Loran for Tactical Applications (LC DELTA), *Thirty-third Annual International Loran Association Technical Symposium*.
- Schue, C. A. III, (2008). The next generation LF transmitter and its impact on Loran, eLoran, and tactical (e)Loran systems, *Royal Institute of Navigation NAV08 conference and Thirty-seventh Annual International Loran Association Technical Symposium*.
- The Radio Technical Commission for Maritime Services, (2008). *Specification of the eLoran System Preliminary, Tentative and Unofficial*. Unofficial Specification.
- United States Coast Guard, (2012). *Loran-C General Information*. <http://www.navcen.uscg.gov/?pageName=loranMain> (accessed 09 15, 2016).
- United States Department of Transportation, (2001). *Vulnerability assessment of the transportation infrastructure relying on the global positioning system*. Government Report.
- UrsaNav. (2015). *eLoran Points of Light*. Q&A Paper.
- UrsaNav. *Loran-C*. <http://www.ursanav.com/solutions/technology/loran-c/> (accessed September 15, 2016).

CHAPTER 25

DOPPLER SONAR NAVIGATION

INTRODUCTION

2500. Doppler SONAR Velocity Logs

Significant improvements in maritime navigation can be obtained by the use of **Doppler Velocity Logs (DVLs)**. These acoustic sensors take advantage of the Doppler principle to provide a very accurate measure of the 3-dimensional velocity of a platform relative to the ground or to the ocean. The velocity over ground measured by the DVLs is much more accurate than can typically be achieved with a ship's **Inertial Navigation System (INS)**, which makes DVLs essential for missions requiring very accurate velocity and position.

Despite the ubiquity of Global Positioning Satellite (GPS) navigation today (see Chapter 22), the DVL still plays an important role in the suite of navigation instruments for surface vessels and a primary role for submerged vessels. The DVL provides an independent source of ship speed that is more reliable and has less random error than either the direct GPS velocity or the time derivative of GPS position. Also, the DVL is able to provide a navigation solution in situations where GPS cannot be used, for example when passing under bridges or near other structures, or in situations where the GPS signal is compromised due to electromagnetic jamming, spoofing, multipath, or unintentional interference from solar activity, geomagnetic storms, or other sources and for submerged vessels where GPS is not readily available. DVLs may also be used directly to aid an INS (see Chapter 20) by damping Schuler oscillations, aiding gyrocompassing, calibrating

gyro and accelerometer bias and alignment errors, and controlling the medium-term growth of position error and the long-term growth of velocity error. Some DVLs can also provide measurements of current velocity near the vessel that may be useful in navigation and ship handling.

When anchoring large surface vessels without the aid of tugs, the speed over ground should be less than 0.3 knot to avoid accidental loss of the anchor and chain. The DVL is better than GPS at providing precise velocity information for this kind of operation. The DVL also can serve as a backup to laser- and radar-based docking aids for large surface vessels to maintain safe docking speeds in the event of failure of those systems.

The integration of GPS receivers into airborne and surface vehicles provides these vehicles with an increase in navigational accuracy that is unavailable to underwater vehicles. The navigation systems for underwater vehicles must rely on an inertial navigation system, a velocity log and gyrocompass, an array of transponders, or a combination of these systems. Although these navigation systems may be initialized with a GPS position fix, once the vehicle is submerged, the navigation system must operate autonomously. Recent improvements in the performance of bottom-tracking DVLs provide underwater vehicles with autonomous navigation accuracies on the order of 0.2 percent of distance traveled. However, vehicles equipped with a DVL are limited to operating at lower altitudes above the ocean bottom.

THE DOPPLER PRINCIPLE

2501. The Doppler Principle

This section introduces the Doppler principle and how it is used to measure relative radial velocity between different objects. The **Doppler effect** is a change in the observed sound pitch that results from relative motion. An example of the Doppler effect is the sound made by a train as it passes (Figure 2501). The train's whistle has a higher pitch as the train approaches an unmoving observer, and a lower pitch as it moves away. This change in pitch is directly proportional to how fast the train is moving. Therefore, by measuring the change in the pitch the speed of the train can be calculated.

Sound consists of pressure waves in air, water or solids. Sound waves are similar to shallow water ocean waves.

- **Waves.** Water wave crests and troughs are high and low water elevations. Sound wave crests and troughs are high and low air pressure.
- **Wavelength (λ).** The distance between successive wave crests.
- **Frequency (f).** The number of waves that pass in a unit of time.
- **Speed of Sound (C).** The speed at which the waves propagate.

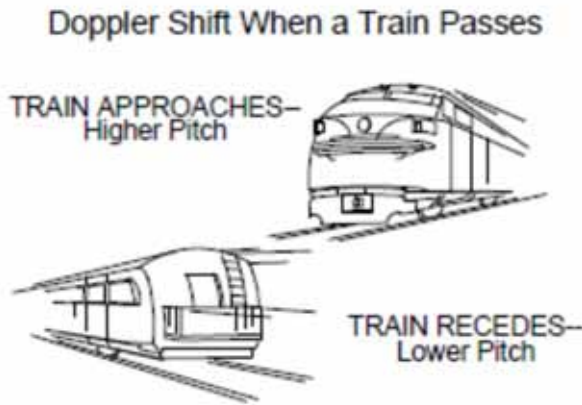

Figure 2501. When you listen to a train as it passes, you hear a change in pitch due to the Doppler shift. Courtesy of Johns Hopkins University - Applied Physics Laboratory.

Speed of Sound = Frequency x Wavelength

$$C = f\lambda$$

Example: A wave with a 300 kHz frequency and wavelength 5 mm will travel at (300,000 Hz) X (.005m) = 1500 meters per second.

Suppose while standing still near water, an observer sees eight waves pass in a given time interval. If the observer starts walking forward toward the waves more than eight waves will pass by in the same time interval, thus the wave frequency will appear to be higher. Similarly, if the observer walks in the opposite direction, away from the waves, fewer than eight waves pass by and the frequency appears lower. This is the Doppler effect. The **Doppler shift** is the difference between the frequency observed when standing still and that observed when moving.

Example. Standing still and you hear a frequency of 10 kHz, and then you start moving toward the sound source and hear a frequency of 10.1 kHz, then the Doppler shift is 0.1 kHz.

The equation for the Doppler shift in this situation is:

$$Fd = Fs(V/C)$$

Where:

- Fd is the Doppler shift frequency.
- Fs is the frequency of the sound when everything is still.
- V is the relative velocity between the sound source and the sound receiver (the speed at which you are walking toward the sound; m/s).
- C is the speed of sound (m/s).

Note that:

- If you walk faster, the Doppler shift increases.
- If you walk away from the sound, the Doppler shift is negative.
- If the frequency of the sound increases, the Doppler shift increases.

DVLs use the Doppler effect by *transmitting* sound at a fixed frequency and *listening* to echoes returning from either sound scatterers in the water or reflected off the ocean bottom. Sound scatters in all directions from scatterers or off the reflected surface. Much of the sound goes forward and is not reflected back. The small amount that reflects back is Doppler shift.

In the case of a DVL mounted on the underside of a vehicle, the vehicle is both a moving transmitter and receiver. The intermediate reflection of the acoustic signal off a water borne scatter or at the ocean bottom is treated as a stationary receiver immediately followed by a stationary transmitter. Because the DVL both transmits and receives sound, the Doppler shift is doubled.

$$Fd = 2Fs(V/C)$$

2502. DVL Transducers

The acoustic transmission and receiver in a DVL is accomplished with transducers. Acoustic transducers are transmitters that convert electricity to sound and also receivers that convert sound to electricity. The active elements in transducers are piezoelectric ceramic disks that expand or contract under the influence of an electric field. The electric field is applied through thin layers of silver deposited on the surfaces of the ceramic. When a voltage is applied, the disk gets thicker or thinner, depending on the polarity of the voltage. The ceramic disk is potted (encased) with polyurethane in a metal cup with a reflective backing material. Transducer quality is essential for data quality.



Figure 2502a. For more information on Janus.
<http://en.wikipedia.org/wiki/Janus>

DVL transducers are normally deployed using the Janus configuration, named for the Roman god Janus often depicted as having two faces looking in opposite directions (see Figure 2502a), which employs four ultrasonic beams, displaced 90° from each other in azimuth, with each directed obliquely at the ocean floor at angle θ_j from the vertical, to obtain true ground speed in the alongship and athwartship directions. The angle θ_j , typically 30°, is known as the Janus angle. Because the DVL combines information from all beams to determine velocity, there is no required orien-

tation for the DVL relative to the ship. The two most common orientations are with opposing beams aligned to the alongship axis (Figure 2502b) or rotated 45° to have two beams pointing forward and two beams aft. Velocity components are measured in the direction of each beam using the Doppler effect on the backscattered acoustic signal. A development of the equation for these beam component measurements from the fundamental Doppler equation for sound propagation is presented in Section 2506.

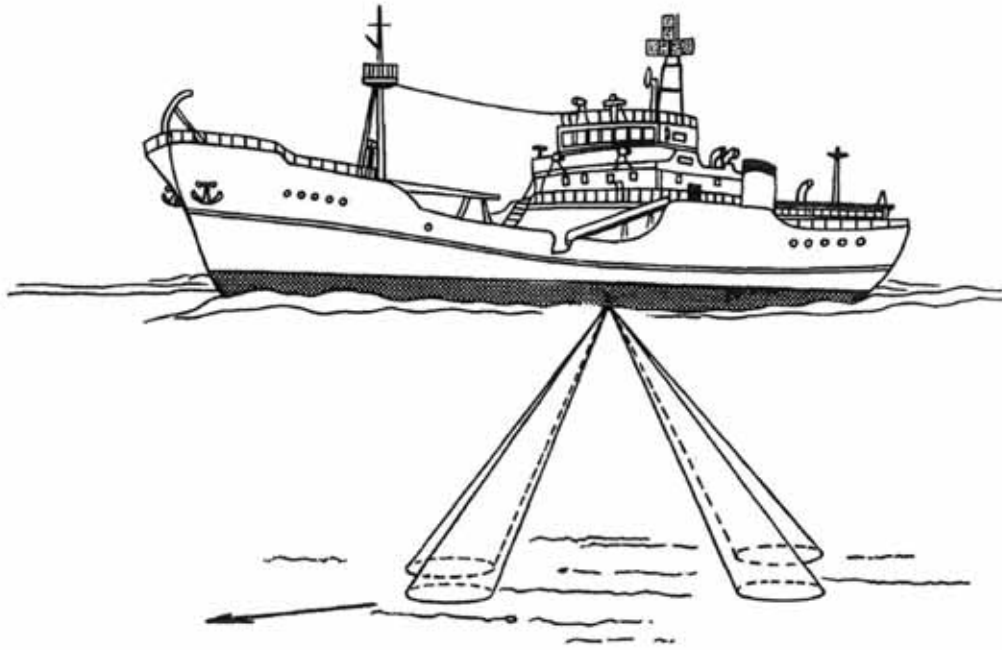

Figure 2502b. Janus configuration.

The advantage of the Janus configuration when the beams of one or both opposite pairs are pinged simultaneously is that the velocity differences within beam pairs that measure the horizontal velocity component are not affected by pitch or heave differences between beams that might occur were pinging to occur separately, nor by the large tilt-and heave-induced errors that could result if only one beam were used in each of the alongship and athwartship directions.

The Doppler theory equations for computing velocity for each DVL beam are given in Section 2506. Typical DVLs employ four-beams to measure three dimensional velocity of a vessel. A system such as this is over-determined as there are more beams than necessary. There are a number of potential solutions for going from a four beam velocity to a three dimensional velocity. The classic solution for solving over-determined systems is to use least squares (Brokloff, 1994).

An alternate approach is to use the redundant 4th beam to compute a direct measurement of a quality control output

known as “error velocity” described in detail below. When the magnitude of the error velocity is unusually large for a particular ping and a bad measurement on a single beam can be identified as the cause, the remaining three beams can still be used to accurately determine the velocity vector.

The vector V_b of four beam-wise velocity components can be converted to the augmented velocity vector V_{inst} in the DVL instrument frame of reference by multiplying on the left by the beam-to-instrument transformation matrix B :

$$V_{inst} = B \cdot V_b$$

$$\text{where } V_{inst} = \begin{bmatrix} u_{inst} \\ v_{inst} \\ w_{inst} \\ e \end{bmatrix}, \quad V_b = \begin{bmatrix} V_{pd} \\ V_{sb} \\ V_{fb} \\ V_{ab} \end{bmatrix},$$

and normally,

$$B = \begin{bmatrix} \frac{-1}{2\sin\theta_J} & \frac{1}{2\sin\theta_J} & 0 & 0 \\ 0 & 0 & \frac{1}{2\sin\theta_J} & \frac{-1}{2\sin\theta_J} \\ \frac{-1}{4\cos\theta_J} & \frac{-1}{4\cos\theta_J} & \frac{-1}{4\cos\theta_J} & \frac{-1}{4\cos\theta_J} \\ -1 & -1 & 1 & 1 \\ \hline 2\sqrt{2}\sin\theta_J & 2\sqrt{2}\sin\theta_J & 2\sqrt{2}\sin\theta_J & 2\sqrt{2}\sin\theta_J \end{bmatrix}$$

and where u_{inst} , v_{inst} , w_{inst} , and e are respectively the nominally starboard, forward, upward, and error velocity components in the instrument frame and V_{pb} , V_{sb} , V_{fb} and V_{ab} are respectively the measured velocity components in the outward direction of the port, starboard, forward, and aft beams. (The beam labels correspond to their nominal azimuth directions in the first common orientation described above.)

Note. Many manufacturers use an inward-positive convention for beam velocities instead, which negates the signs of all elements of the beam-to-instrument matrix B . The outward-positive convention is used here to aid intuition when discussing the Doppler effect on the forward beam.

In general, the first three rows of B are the Moore-Penrose pseudoinverse of the 4×3 beam direction matrix having four rows, each row being the unit vector in the outward direction of a beam. These unit vectors can be determined during factory calibration. The elements of the B matrix shown above are the nominal values to be expected if there are no manufacturing deviations in beam orientation.

The last row of B is constructed to be orthogonal to the other three rows and normalized to make its magnitude (root-mean-square) match the mean of the magnitudes of the first two rows. It corresponds to the error velocity e , extra information in V_{inst} that augments the velocity vector comprising the first three of its elements. Its scaling was chosen so that the variance of the error velocity should have the same expected value as the portion of the variance of either of the two horizontal velocity components attributable to instrument noise rather than vessel motion. The expected value of the error velocity is zero.

The error velocity is useful for screening to exclude improbable measurements. In cases where the magnitude of the error velocity is unusually large compared to its standard deviation and the bad beam can be identified by, for example, the fact that its correlation coefficient is much lower than that of the other three beams, then the redundancy provided by having four beams allows the velocity vector to be determined by using the valid measurements from the three remaining beams. The algorithm that does this is equivalent to setting the error velocity e to zero and solving the equation corresponding to the last row of matrix

B for a value to replace the rejected measurement from the bad beam, then continuing with processing as if all four beam measurements were known.

If the vessel's pitch and roll measurements are available from a gyrocompass, vertical gyro, or other sensor, they can be used to implement a coordinate frame rotation to give leveled horizontal velocity components in any sea state. This is known as the leveled ship frame. Likewise, heading from a magnetic compass, two-antenna GPS compass, gyrocompass, or INS can be used to calculate the velocity components in the geographic frame. These steps are shown in detail below.

If the DVL is not installed precisely aligned with the vessel axes, it is convenient to first rotate the measured velocity vector from the instrument to the ship frame using a constant alignment rotation matrix A :

$$V_{ship} = A \cdot V_{inst}$$

$$\text{where } V_{ship} = \begin{bmatrix} u_{ship} \\ v_{ship} \\ w_{ship} \end{bmatrix}, \text{ and}$$

and nominally,

$$A = \begin{bmatrix} CH_A CR_A + SH_A SP_A SR_A & CH_A SP_A SR_A - SH_A CR_A & -CP_A SR_A & 0 \\ SH_A CP_A & CH_A CP_A & SP_A & 0 \\ CH_A SR_A - SH_A SP_A CR_A & -(CH_A SP_A CR_A + SH_A SR_A) & CP_A CR_A & 0 \end{bmatrix}$$

and the abbreviations C for **cos** and S for **sin** have been made in matrix A for notational convenience. The three angles H_A , P_A , and R_A respectively represent the heading, pitch, and roll of the vessel necessary to make the instrument be level and heading so the nominally-forward beam points north. For example, if the "forward" beam is installed to point 45° to port but is otherwise level, you would nominally use $H_A = 45^\circ$, $P_A = 0^\circ$, and $R_A = 0^\circ$. Calibration of H_A , P_A , and R_A is discussed in the next section. When these angles are small, they essentially act as angle offsets that respectively subtract from the effective heading, pitch, and roll applied in the next velocity rotation steps discussed below. Of course, there are many possible ways to define the alignment matrix A ; this one has the advantage of keeping the adjustment angles well-defined and unambiguously communicated as ship attitudes. If the vessel's heading and attitude sensors are used with the DVL, then the rotation by A is necessary to align the velocity measurement with the axes of those sensors. Otherwise, this step is merely a convenience to allow the DVL's internal sensors to measure and report the vessel's heading and attitude instead of its own. In either case, the heading, pitch, and roll can be considered to be those of the vessel, not the instrument.

The next step is to rotate the velocity from the ship frame to the leveled ship frame by removing the effects of

pitch P and roll R :

$$V_{level} = L \cdot V_{ship}$$

where
$$V_{level} = \begin{bmatrix} u_{level} \\ v_{level} \\ w \end{bmatrix}, \text{ and}$$

$$L = \begin{bmatrix} 1 & 0 & 0 \\ 0 & \cos P & -\sin P \\ 0 & \sin P & \cos P \end{bmatrix} \cdot \begin{bmatrix} \cos R & 0 & \sin R \\ 0 & 1 & 0 \\ -\sin R & 0 & \cos R \end{bmatrix} = \begin{bmatrix} \cos R & 0 & \sin R \\ \sin P \sin R & \cos P & -\sin P \cos R \\ -\cos P \sin R & \sin P & \cos P \cos R \end{bmatrix}$$

According to the right-hand rule convention used here for the leveled ship frame, u_{level} is the drift to starboard, v_{level} is the forward speed of the vessel, and w is the upward velocity component.

If the velocity is desired in the geographic frame instead of the leveled ship frame, say for dead reckoning purposes, the velocity can be rotated yet again using the heading H :

$$V_{geo} = G \cdot V_{level}$$

where
$$V_{geo} = \begin{bmatrix} u_E \\ v_N \\ w \end{bmatrix}, \text{ and}$$

$$G = \begin{bmatrix} \cos H & \sin H & 0 \\ -\sin H & \cos H & 0 \\ 0 & 0 & 1 \end{bmatrix}$$

and u_E and v_N are respectively the east and north components of the horizontal velocity.

2503. DVL Operational Errors

Long-term, systematic errors can be divided into instrument errors inherent to the technology, discussed in the next section, and operational errors that may be ameliorated by the user through proper installation, calibration, operation, and choice of accessory sensors, which we address here. Operational errors may be classified as *alignment errors*, *vessel motion induced errors*, *velocity of sound errors*, *interference errors*, *measurement outliers*, and *power loss errors*.

Alignment errors. If the DVL is not properly aligned with the compass's lubber's line, a dead-reckoned course will show a cross-track drift from the true course when compared to GPS. When using a magnetic compass, it may be difficult to distinguish this misalignment from compass variation. Most DVLs accept a calibration correction similar to H_A in the previous section to offset one or both of these angular errors.

When no pitch and roll measurements are available and the DVL is not level, or when the DVL is not properly aligned with the vertical fiducial of the pitch-roll sensor, the velocity measurement will be reduced by a factor equal to the cosine of the mean pitch angle (trim) or its residual error, assuming that the vessel is moving forward without leeway. This error can be detected by the DVL measuring a significant average vertical velocity, and the pitch error can be measured as the arctangent of the ratio of average vertical velocity (w) to average forward velocity v_{level} . This error is generally small; for example, an uncorrected trim (or list) of 4° will reduce the alongship (or athwartship) speed signal by about 0.25%. Calibration of the pitch alignment parameter P_A in the previous section can be accomplished by increasing the value of P_A by $\arctan(\langle w \rangle / \langle v_{level} \rangle)$. Similarly, R_A should be increased by $\arctan(\langle w \rangle / \langle u_{level} \rangle)$, but creating a significant average drift velocity $\langle u_{level} \rangle$ for the vessel may require use of a cross-current, side thrusters, or tugs in order to calibrate

Vessel motion induced errors. While alignment errors are caused by mean attitude offsets, there are additional analogous errors caused by dynamic fluctuations in pitch and roll when these are not measured and corrected. The alongship and athwartship velocity components averaged in the ship frame are biased low compared to averaging in the more stable leveled frame by a factor equal to the cosine of the standard deviation of the pitch and roll fluctuations, respectively. Even in the leveled ship frame or geographic frame, if an inadequate pitch/roll sensor is used that is not gyro-stabilized against contamination by wave-induced accelerations, there will be a similar bias effect multiplying the average horizontal velocity components by the cosine of the standard deviation of the resulting pitch and roll errors.

Analogous errors come from heading fluctuations. Dead reckoning calculation of progress along a course leg should be made in the more stable geographic frame to avoid the bias factor equal to the cosine of the standard deviation of the actual heading fluctuations. Even in the geographic frame, there is a cosine of the heading sensor errors factor that will bias the distance made good low.

Wave-induced motions of the vessel may cause speed fluctuations that may obscure the vessel's average speed over ground, but these fluctuations are not actual errors in the sense that they do reflect the ship's true motion. Some speed logs filter the output by providing a running average over several pings to reduce these fluctuations along with *random instrument errors*, with the unfortunate drawback of introducing a time lag to the speed measurement.

Velocity of sound errors. DVLs having transducers of the piston type directly measure the Mach number for the velocity component along each beam, which must be multiplied by the speed of sound to calculate the beam velocity. Therefore, the relative uncertainty in the sound speed results in a relative systematic error, or "scale factor bias," of

the same percentage. Although the sound speed varies over the water column and the deflection of sound rays by refraction depends primarily upon the mean sound speed over the water column, the sound speed needed by piston DVLs is that of the water at the transducer location. This is because of Snell's law of refraction, which implies that in horizontally-stratified water, the ratio of the sound speed to the sine of the sound ray inclination to the vertical is preserved throughout the water column. Hence, we must know the sound speed at the point where we know that the ray inclination is the Janus angle, which is at the transducer.

The speed of sound in bubble-free seawater depends upon temperature, salinity, and depth (of importance to submarines), but not frequency. The temperature dependence is the strongest but also the easiest to measure and compensate for in the DVL firmware using an empirical sound speed formula. Salinity is more inconvenient to measure but also less important, the sensitivity of sound speed being only about 0.1% per g/kg of salinity. However, in the brackish water of inlets and estuaries, the uncertainty in the salinity can be significant. In some installations an acoustic velocimeter may be used to directly measure the sound velocity in the vicinity of the transducer. Most commercially available DVLs accept a variety of different forms of sensor input to determine the sound speed factor used to convert Mach number to velocity.

A piston DVL can be mounted behind a flat window made of acoustically-transparent plastic with fresh water between the transducer and the window. The DVL is configured for a salinity of 0 g/kg and refraction at the window face automatically adjusts the Janus angle of the beams outside the window to compensate for the sound speed change due to the salinity of the sea water. Another scheme to avoid sound speed uncertainty is to use plastic prisms between the tilted transducers and the horizontal window, and employ a sound speed formula for the plastic as a function of temperature.

DVLs having phased array transducers not only have the advantage of smaller size by generating all four beams from a single aperture, but also of sound speed independence in the measurement of velocity components in the plane of the array. In fact, for horizontal motion of a level phased array in the direction of a beam azimuth, the Doppler shift is also independent of frequency, being (in hertz) half the ratio of the speed to the array stave spacing. The actual Janus angle doesn't matter to the measurement, although its sine does change slightly in proportion to sound speed and varies inversely with frequency over the bandwidth of the projected signal, always giving the same Doppler frequency shift for a given horizontal speed. In contrast, measurement of the velocity component perpendicular to the face of the phased array does depend upon sound speed, but since pitch is typically small, the propagation of speed-of-sound error into vessel speed is usually negligible.

Interference errors. Acoustic interference from other

sonars having fundamental or harmonic frequencies near those used by the DVL can result in altitude error from false bottom lock, velocity bias, and other symptoms of jamming. This problem can be avoided by synchronizing multiple sonars to a ping schedule that avoids simultaneous pinging.

Outliers. While most DVL velocity errors have a nearly Gaussian distribution, unusual random events such as Rayleigh fades and ambiguity errors can occur that cause large errors with a higher probability than a bell-shaped curve would predict. For good performance, especially when dead reckoning, it is important to screen the measurements to remove outliers. DVLs may screen the velocity measurements automatically based upon loss of bottom lock, signal-to-noise ratio (SNR), relative intensity among beams, correlation coefficient, and/or error velocity, usually replacing bad measurements with the value from the previous good ping. Although threshold values for some of these screening tests may be under user control, the factory default settings are adequate under most conditions.

Power loss errors. The DVL requires a certain minimum SNR to detect the bottom and to distinguish the ping echo signal from thermal and ambient acoustic noise. The SNR, and thus the maximum altitude (maximum water depth for surface vessels), is affected by acoustic losses, some of which vary with environmental conditions. The most important of these are the temperature and salinity dependence of acoustic absorption by the seawater and variability in the bottom backscatter coefficient. Usually, increasing temperature decreases the maximum altitude for seawater, although at lower frequencies the best range performance is reached at moderate temperatures. At 30° C the maximum range may be reduced by as much as 30%. The maximum range is significantly greater in fresh water than in seawater.

At water depths near the maximum operational altitude of the DVL, near-surface bubble clouds may reduce the signal strength enough to cause dropped measurements, resulting in non-uniform sampling. If the motion of the vessel through the waves causes the timing of the presence of these bubbles and the resulting dropouts to be correlated with the wave-induced motion, the average of the remaining measurements may be biased. Three additional phenomena that can reduce signal strength in rough seas are (1) greater acoustic attenuation from the greater path length, (2) reduced bottom backscattering strength, both effects largest for a beam at its greatest angle from the vertical at maximum roll, and (3) rotation of the beam away from the direction toward which the sound was projected during the time interval between projection and receipt of the acoustic signal, which is worst at high altitudes and roll rates. Although the timing of these phenomena may vary relative to that of the bubbles, the dropouts they cause may also be correlated with the wave-induced motion of the vessel and thus sources of sampling bias. Therefore, the accuracy of the DVL output may be degraded when there

are frequent dropouts in rough seas.

2504. Systematic Instrument Errors in DVLs

DVLs are subject to a number of long-term (i.e., systematic) errors besides those discussed in the previous section, the three most important kinds being *terrain*, *absorption*, and *sidelobe beam-coupling biases*.

Terrain bias. Because the bottom backscatter strength is a strong function of incidence angle, the side of the beam closer to the vertical is weighted more than the outer side, reducing the effective Janus angle and biasing the velocity low by some percentage. Although a typical value of this bias can be calibrated out, variability in the slope of the bottom backscatter strength function with incidence angle make the terrain bias depend upon bottom type. Flat, muddy bottoms generally give more terrain bias than rough rocky bottoms.

Absorption bias is similar to terrain bias in that it weights the inside of the beam more than the outside, but the cause is acoustic absorption over a shorter or longer path rather than differential bottom backscatter strength. Unlike terrain bias, which is independent of altitude, absorption bias is proportional to altitude and therefore worst at maximum depth. Absorption bias could be corrected if the water properties needed to estimate the acoustic absorption coefficient were known over the entire water column, but since they generally are not, most DVLs do not attempt to make a correction proportional to altitude.

Sidelobe beam-coupling bias is caused by acoustic leakage of the signal from opposite and neighboring beams through sidelobes of the beam pattern of the desired beam. This may become a problem when bottom slope, roll, or some other phenomenon increases the relative intensity of one or more of the unwanted beam contributions or reduces that of the beam being measured. For narrowband DVLs and for broadband DVLs at low speeds, this error behaves as a negative scale factor bias (i.e. the error is proportional to speed). For broadband DVLs at higher speeds, the velocity error is a periodic function of velocity, making its relative size less with increasing speed. Sidelobe beam-coupling bias can be avoided by pinging each beam separately in shallow water or by using different transmitted signals in different beams. Of the three kinds of systematic errors discussed only sidelobe beam coupling bias affects water-relative velocity measurements in the volumetric scattering mode.

All three kinds of systematic errors discussed above are reduced by using narrower beams, which requires either larger transducer diameter or higher frequency. DVLs can be calibrated against GPS to calculate a correction factor to remove these systematic errors, but in general, the correction will not universally apply. For submarines, DVL-aided INs can calibrate scale factor bias against the more accurate INS accelerometer scale factor by doing turning or speed-changing maneuvers that create accelera-

tions observable by a Kalman filter.

2505. Basic Design Considerations

Beamwidth. Beamwidth should be small enough to keep the systematic errors discussed in the previous section to reasonable levels, yet not so small that vessel motion causes signal loss in heavy seas. The width of the acoustic beam is inversely proportional to the diameter of the acoustic transducer. Most DVLs have transducer diameters between 15 and 30 wavelengths, the number generally lower at lower frequencies because of the greater cost of transducer size for larger systems and the longer acoustic travel time in deeper water causing greater SNR loss due to vessel motion.

Frequency. A high acoustic frequency is desirable for reducing transducer size and maximizing the Doppler phase shift. However, at higher frequencies the absorption loss is very nearly proportional to the square of the frequency. As the frequency is decreased, the loss tends to become linear. As the frequency is reduced to obtain greater maximum depth of operation in the bottom return mode, the transducer size grows increasingly large. Improvement in operating depth diminishes near 100 kHz while transducer size has increased considerably. Therefore, the frequency selected is a trade-off among desired maximum operating depth, transducer size, and cost. The region between 150 and 600 kHz is finding the greatest application.

Transmitted acoustic signal. The bandwidth of the transmitted signal is a programmable design variable. Narrowband transmissions achieve the greatest range at a particular frequency by minimizing thermal and ambient noise, at the expense of more erratic behavior due to stochastic signal fades that can occasionally prevent bottom lock. The narrowband mode also has additional sources of systematic error. In shallow to moderate water depths, where signal-to-noise ratio is not an issue, wider bandwidth produces more stable measurements with less random error. The signal bandwidth can be controlled independently of the duration of the projected pulse by phase-coding the signal. Most DVLs use a pulse duration that is a significant fraction of the travel time in order to fully ensonify the bottom, which greatly reduces the self-noise, one source of random error. In shallow water, the so-called “pulse-to-pulse coherent mode” having particularly low short-term error is also available, in which bottom echoes are received from each of two or more pulses before the next pulse in the transmission has been projected.

2506. Doppler Theory

A DVL relies on incoherent scattering of sound off the bottom, as opposed to specular reflection, so it tracks individual bottom scatterers that are *ensonified* by its beams. As a vessel moves over a sloping bottom, the velocity component measured by a beam will in general be unrelated to the

time derivative of the range to the bottom along that beam, the latter being affected by new scatterers entering the beam at a slightly different range that have no velocity themselves.

The frequency of a plane wave signal of a particular wavelength is proportional to the rate of propagation of its phase fronts (pressure crests), which is the sound speed c in a reference frame moving with the water, but the rate is offset from c by the component of vessel velocity perpendicular to the phase fronts (i.e., parallel to the acoustic beam) in a reference frame moving with the vessel. For example, if the vessel is moving with vector velocity \mathbf{V} and there is no current, then the forward beam-wise velocity component is $V_{fb} = \mathbf{V} \cdot \hat{i}_{fb} = u \sin \theta_j - w \cos \theta_j$ where \hat{i}_{fb} is the unit outward vector in the direction of the forward-pointing beam. The frequency of the signal projected into the forward beam will be increased by the factor $f_w/f_p = c/(c - V_{fb}) = (1 - M_a)^{-1}$, where f_w is the frequency observed in the water frame, f_p is the frequency projected by the vessel, and M_a is the beam Mach number V_{fb}/c . When there is no current, *backscatter* does not change the frequency of the signal in the water frame, it simply reverses its direction. Upon returning to the vessel, the frequency will increase again by the factor $(1 + M_a)$, for a total of $\frac{1 + M_a}{1 - M_a}$. Subtracting 1 gives the Doppler shift factor:

$$\frac{\Delta f}{f_p} = \frac{2M_a}{1 - M_a} = \frac{2V_{fb}}{c - V_{fb}} = 2 \frac{u \sin \theta_j - w \cos \theta_j}{c - u \sin \theta_j + w \cos \theta_j}$$

If this derivation is repeated with one or more water layers moving with the current, it will be found that the current only adds terms of order M_a^2 relative to the measurement, which are negligibly small.

For DVLs with piston transducers, the sound speed c at the transducer must be known to calculate the velocity from the Mach number. For phased arrays, the ratio $2(f_w/c) \sin \theta_j$ is equal to $1/(2d)$, where d is the stave spacing of the array and $f_w = f_p/(1 - M_a)$ is the frequency in the water frame, which is the average of the projected and received frequencies. The Doppler shift is therefore:

$$\Delta_f = 2f_w M_a = \frac{1}{2d}(u - w \cot \theta_j)$$

which is independent of frequency or sound speed for phased arrays in horizontal motion. Hence when $w = 0$, all frequency components of the signal experience the same Doppler *frequency shift* in phased arrays, whereas they experience the same relative *Doppler shift factor* in piston transducers.

The Doppler effect on a signal can alternatively be understood in the time domain as a small change in the time of arrival of repeated portions of the signal, no matter how narrow or wide its bandwidth. In a frame of reference fixed to the water, the point midway between the projection location and the point where the backscattered signal is received is known as the *phase center*. The displacement of the phase center over the lag t_L at which the projected signal repeats is $V(t_L - \frac{1}{2}\Delta t)$, where Δt is the amount of $V \cdot \hat{i}_{fb}(t_L - \frac{1}{2}\Delta t)$ to the sound displacement $c t_L$ in the same interval:

$$\frac{\Delta t}{t_L} = 2M_a \left(1 - \frac{1}{2} \frac{\Delta t}{t_L}\right) = \frac{2M_a}{1 + M_a} = \frac{2V_{fb}}{c + V_{fb}}$$

where the last two expressions come from solving the first equation for $\Delta t/t_L$, and are equal to $\frac{\Delta f}{f_r}$, where $f_r = f_w(1 + M_a)$ is the received frequency. Solving the equation above for the forward beam velocity V_{fb} , we have:

$$V_{fb} = u \sin \theta_j - w \cos \theta_j = \left(\frac{c}{2t_L}\right) \frac{\Delta t}{1 - \frac{1}{2}\Delta t/t_L} = \left(\frac{c}{4f_0 t_L}\right) \frac{2f_0 \Delta t}{1 - \frac{1}{2}\Delta t/t_L}$$

with similar equations for the other beams. Most broadband DVLs having piston transducers measure $f_0 \Delta t$ using the phase of the demodulated signal autocorrelation function at or near the repeat lag t_L . The frequency f_0 is that of the local oscillator used for demodulation. The coefficient $\frac{c}{4f_0 t_L} = U_a$, known as the “ambiguity velocity,” represents the velocity at which the phase is in radians, after correction for the non-linear denominator $1 - \frac{1}{2}\Delta t/t_L$. For narrowband DVLs, any lag can be used within the reciprocal of the signal bandwidth.

For phased array DVLs, it is useful to multiply Δt by the receive frequency $f_r = f_w(1 + M_a)$ to calculate the phase, which is the same at all frequencies:

$$f_r \Delta t = 2f_w t_L M_a = t_L \Delta f = \frac{1}{2U_{a0}} \left(u \sin \theta_0 - w \cos \theta_j \left(\frac{\sin \theta_0}{\sin \theta_j} \right) \right)$$

where $U_{a0} = \frac{c_0}{4f_0 t_L} = \frac{d}{t_L} \sin \theta_0$ is the ambiguity velocity at a standard sound speed defined by the choice of stave spacing d , and θ_0 is the nominal beam Janus angle, typically 30° . Broadband phased array DVLs use the phase measured

from the demodulated signal autocorrelation function at or near t_L to measure $f_r \Delta t = t_L \Delta f$. The vertical and horizontal velocity components can be separated by respectively adding and subtracting the measurements from opposite beams (see Section 2502). Although the sensitivity of the vertical velocity component to sound speed is typically 33% greater for phased arrays than it is for pistons, there is no sound speed sensitivity at all for the nominally-horizontal components parallel to the array face.

2507. References

Brokloff, N. A., (1994). *Matrix algorithm for Doppler sonar navigation*. Oceans '94. MTS/IEEE Conference Proceedings1994[3]:378-383. ©1994 IEEE. **Reprinted, with permission, from IEEE Proceedings.**

Brokloff, N. A., (1997) *Dead reckoning with an ADCP and current extrapolation*. Oceans '97. MTS/IEEE

Conference Proceedings1997[2]:1411-1416. ©1997 IEEE. **Reprinted, with permission, from IEEE Proceedings.**

Kritz, J. and Howard M. J., (1969). *Channel Navigation and Docking of Supertankers*. NAVIGATION: Journal of the Institute of Navigation 16[1].

Laster, D. R., and Fagan J. W., (1965). *Exploratory Evaluation of Underwater Doppler Navigators*. U. S. Navy Marine Engineering Laboratory Evaluation.

Leroy, C. C., Robinson, S. P., and Goldsmith, M. J., (2008). *A New Equation for the Accurate Calculation of Sound Speed in all Oceans,* J. Acoust. Soc. Am. 124[5]:2274-2783,

RD Instruments, (1996). *Acoustic Doppler Current Profiler, Principles of Operation A Practical Primer*, 2nd Edition for Broadband ADCPs, RD Instruments. **Used with permission from Teledyne RDI.**

CHAPTER 26

BATHYMETRIC NAVIGATION

BASIC TECHNIQUES OF BATHYMETRIC NAVIGATION

2600. Introduction

Until the arrival of this age of electronic technology, mariners relied solely on celestial navigation, paper charts and mechanical soundings techniques to navigate the world's oceans. Now, however, satellite technology, GNSS, and electronic positioning systems are capable of achieving sub-meter positioning accuracy, and vessels can even navigate using automated means alone. Satellite navigation has become so reliable that some maritime academic institutions have removed celestial navigation from their curriculum. Hydrographic offices, too, put the bulk of their efforts on producing electronic navigational charts in response to increasing industry demand for digital products and decreasing need for paper charts.

However, all things electronic are subject to the potential for failure, and as technology advances it is possible to become over-reliant on a single set of tools. As the maritime sector gradually acknowledges this vulnerability, there is renewed interest in traditional navigation techniques. For example, bathymetric navigation, which utilizes charted seafloor features and contours to help determine the position of a vessel, is once again being actively used in combination with celestial navigation or dead reckoning to provide a position solution in the absence of satellite navigation.

2601. Bathymetry and Bathymetric Navigation

Bathymetry is the science of mapping seafloor relief. Accurate bathymetric surveys help hydrographers identify submerged hazards to navigation, and allow oceanographers and geologists to better understand seafloor morphology and its impact on the ocean environment.

The principle behind bathymetric navigation is simple. When a mariner knows a vessel's last position with reasonable confidence, and has nautical charts that depict soundings, seafloor features and depth curves, then the mariner can use those charted bathymetric features to refine their assumed position.

For example, if a mariner were to be navigating in the vicinity of a charted seamount, and there exists a measure of uncertainty regarding the accuracy of their positioning fix, the mariner can validate the vessel's position by comparing echo sounder readings with the assumed position while sailing over the submerged seamount.

The usefulness of this technique is dependent up on several factors: the accuracy of the chart, the reliability of the last position fix, and the capabilities of the vessel's echo sounder.

The National Oceanographic and Atmospheric Administration (NOAA) produces a series of bathymetric maps of the waters adjacent to portions of the coast of the United States. These maps extend seaward somewhat beyond the 100-fathom curve and show the contour of the bottom in considerable detail. Such maps can be of great assistance in fixing position by means of the depth finder. The maps are available online and can be accessed via the link provided in Figure 2601.



Figure 2601. NOAA - U.S. Bathymetric Maps
https://www.ngdc.noaa.gov/mgg/bathymetry/maps/nos_intro.html

2602. Nautical Charts

Nautical charts are compiled from a combination of bathymetric surveys, soundings collected using a variety of historical techniques, and depths reported by mariners. Although it may be tempting to assume that where there are soundings on a chart, the area has been thoroughly surveyed, this can be a dangerous presumption. It is not an over-generalization to say that most of the world's oceans are still unsurveyed.

The ocean is vast, and although technology is always improving, modern hydrographic surveys are still expensive and time-consuming. In many areas, charted soundings are compiled from pre-1900 lead line surveys, or from 20th century singlebeam echo sounder surveys (see chapter on Hydrography for more information about survey techniques). These survey methods do not provide full sea floor coverage, and could miss significant seafloor features.

In addition, much of the depth information in nautical charts was collected before modern satellite positioning

techniques were available. This introduces a degree of uncertainty in the location of some charted depths. Mariners should always consult the chart's source diagram to determine the type and age of data that was used to compile soundings for any specific region of the chart, and always use the best-scale, most current product available for bathymetric navigation.

2603. Positioning

When vessels navigate using GNSS, mariners can usually be confident in the accuracy of their position fix. There may be times when the quality of the satellite signal degrades due to poor geometry overhead, or steep terrain that blocks signals or causes multipath (such as in narrow fjords), but generally, satellite navigation is reliable.

If, however, a navigator is unable to use satellite positioning systems, they will need to rely on other methods, such as celestial navigation or dead reckoning (or a combination of the two). With accurate celestial navigation measurements, obtained through practice and skill, mariners can determine their position with a reasonable degree of accuracy (see Part 3 on Celestial Navigation for more information).

When persistent inclement weather or overcast skies prevent mariners from taking star sights or sun fixes, then mariners must resort to dead reckoning. Dead reckoning measures the amount of time elapsed since the last known position fix, the speed of the vessel, its ordered course, and known set and drift to derive an estimate of the vessel's location. The reliability of dead reckoning degrades with time, as the compilation of slight errors compound.

Because there is almost always some uncertainty in position fixes when using celestial navigation and dead reckoning, mariners find it useful to better determine their location using bathymetric navigation.

2604. Echo Sounders

Most modern vessels, from small pleasure boats to large cargo ships, have some type of electronic echo sounder mounted on the keel. These echo sounders measure the time it takes for a pulse of sound to travel to the seafloor and return to the transducer. This measurement of time is then electronically translated into a depth measurement, and the navigator of the vessel uses the depth measurement, in tandem with a nautical chart, to determine a safe course.

Echo sounders vary widely in design and capability. Many models collect depth information about only a narrow cone of water beneath the vessel. These may be referred to as singlebeam SONAR, fathometers, or depth finders. Some higher-end models emit many beams of sound, in a wide swath below, or in front of the vessel. These designs are called multibeam systems, and are capable of generating a very high-resolution three-dimensional SONAR image of the seafloor or approaching obstacles (see chapter on Hydrography for more

information about echo sounder designs).

All echo sounders are limited to a certain depth operating range, which is constrained by the power and frequency of the system. In general, shallow-water echo sounders will be higher-frequency, and require less power. Deep-water echo sounders will be lower-frequency, and require more power. Echo sounders are capable of detecting smaller features in shallow water, and their resolution degrades with depth pulses.

Before attempting bathymetric navigation, mariners should determine what kind of echo sounder they have on board. This will help them identify the capabilities and limitations of their system. For instance, with a singlebeam echo sounder, the mariner would be able to compare charted soundings to depth measurements, and follow patterns in depth trends that correspond to charted contours. With a multibeam echo sounder, mariners might be able to generate very high-resolution SONAR maps of the seafloor. While this could help the mariner identify charted features, it is also possible to collect higher-resolution data than depicted on the chart!

Regardless the type of echo sounder used, it is likely that, at some point, vessels will collect depth information in transit where there is no charted data. This information can be valuable for oceanographic studies, hydrographic purposes, and the greater public good. For those who will donate their data, the International Hydrographic Organization (IHO) supports a crowdsourced bathymetry initiative that encourages mariners to connect data loggers to their echo sounders, and submit the collected information to a public database. For more information, See the link provided in Figure 2604 or visit www.iho.int.

It is also possible to collect depth information without an echo sounder in shallow water, using a lead line or sounding pole. These techniques are not widely used today, as they are time-intensive, and require stopping the vessel and manually deploying a weighted line or long pole over the side. However, they are reliable methods of obtaining depth information, and in theory can be used to compare charted depths with measured soundings.



Figure 2604. IHO World Bathymetry
https://www.iho.int/srv1/index.php?option=com_content&view=article&id=300&Itemid=744&lang=en

2605. Sound Velocity

Mariners should be aware that the depth measurements

collected by echo sounders will vary based on the temperature, salinity, and depth of the local water column. Each of these factors has an impact on the speed and path of sound waves through water. In general, sound travels faster through warm water, saltier water, and deeper (denser) water.

Because echo sounders generate a depth measurement based on the two-way travel time of a sonar beam, differences in water column composition can generate variations in depth measurements. For example, if a vessel travels through a coastal area where a freshwater river runs into the sea, the speed of sound will slow, and the depth measurement may be slightly incorrect.

Some echo sounders have a surface sound velocimeter installed on the hull to at least partially correct for these local water column variations, others do not. Before

attempting bathymetric navigation, one should determine whether or not the echo sounder is equipped with integrated sound velocity corrections.

2606. Other Considerations

Sound waves from an echo sounder will reflect off of anything in the water column, and may even penetrate the surface layer of soft or muddy bottom sediment, and reflect off of the underlying bedrock. Fish, bubbles (from marine life or another ship's wake), dense layers of plankton or marine life, vegetation, variations in salinity, and marine mammals can all cause 'false bottom' readings, or obscure the true bottom. Mariners should be aware of these exceptions when using fathometers to identify seafloor features.

BATHYMETRIC NAVIGATION USING FEATURE RECOGNITION

2607. The Basics

Once the mariner has obtained an initial position fix, determined a rough assessment of the age and accuracy of the information used to compile their chart, and identified the type of echo sounder that is mounted in their vessel, they are ready to use bathymetric information to verify their position.

For the purposes of this chapter, we will assume that the mariner is using hardcopy charts and non-satellite positioning methods, and is navigating out of sight of land. Note that if the mariner is within sight of land, it may be easier and more accurate to verify position by simply taking bearings on features on shore, rather than by comparing bathymetric features to echo sounder readings.

If the mariner is beyond the sight of land, they should choose a prominent charted seafloor feature or set of features that fall near their estimated position, and are at a depth that permits the vessel to safely transit across it. The features should be unique enough to be readily detectable (such as seamounts, ridges or canyons), but should not be complex or 'clumped' features, as they will be more difficult to distinguish and use for positioning. The feature should have enough relief to be easily distinguishable from the surrounding seafloor. If the seafloor is flat and featureless bathymetric navigation will not work, as all depths will appear relatively uniform.

Ideally, the mariner should select a feature that falls within an area recently surveyed for hydrographic purposes (as indicated on the source diagram); those features are likely to be more accurately and fully represented than features from other sources. For example, if an area was fully surveyed using multibeam sonar, a cartographer knows exactly where the 50m contour is located. If an area was surveyed with isolated lead line soundings, the cartographer has to make an educated guess about where to draw the 50m contour between soundings.

If there are no recent hydrographic surveys in the area, the mariner should simply choose a feature that is prominent, and is not listed as 'reported,' 'position doubtful,' etc. Some features that may be useful for bathymetric navigation are:

- Seamounts (isolated or in small groups)
- Ridges
- Canyons
- Plateaus

Once the mariner has selected the feature or set of features, they should plot a course across the feature (or features), reduce vessel speed so that the echo sounder return provides a clear and easily readable bottom trace, and then transit over the feature, attempting to intersect it in a direction that provides the clearest delineation of its location.

If the mariner is using a ridge or a canyon to verify position, the vessel should cut across the feature in a direction that is perpendicular to its main (long) axis. The echo sounder will provide a clear profile of the sides of the feature, and the positions and depths can then be compared to the contours or depths on the chart.

If the mariner is using a plateau or seamount to verify a position fix, the vessel may need to make one or more passes over the feature, which each line offset at a different angle from the last, to ensure that they have located the feature, and not just clipped the edge. If the area is poorly surveyed, caution should be exercised when doing this, to prevent the vessel from encountering a portion of the seamount that is shoaler than charted.

Whenever possible, it is best to transit more than one feature in a row, as locating multiple features that area aligned at a single known bearing provides the most accurate position verification

2608. Additional Considerations

When using bathymetric features to validate a position fix, it is important to note that the vessel's last known position should be reasonably reliable. If there are gross errors in dead reckoning measurements or celestial navigation calculations, bathymetric positioning will be of little value, as the mariner will be searching in the wrong area to begin with. Bathymetric navigation

should be used as a refinement of last known position, not the sole positioning determination method.

In addition, it should be noted that the sonic footprint of some singlebeam echo sounders can make the sides of submerged features appear more rounded than they actually are (Figure 2608). This should be taken into account when comparing charted contours to echo sounder traces.

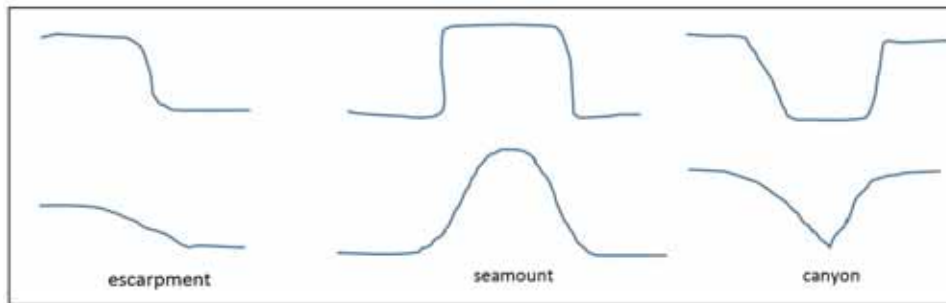

Figure 2608. Bottom features (top row) compared with measured echogram (bottom row).

2609. Other Positioning Methods

Profile-matching. If a vessel is operating in an area where there are no significant features, but the charted contours are varied enough to assist with position identification, a vessel could transit back and forth across the area in a grid pattern, recording the depth profiles with each pass, and then correlate those sequential profiles to the charted contours.

Profile-matching is more time-consuming than the feature recognition method, but if executed properly, and where good comparison contour data is available, this could yield very accurate positioning information. If the vessel has a multibeam echosounder on board, this process would produce a fairly high-resolution map of the seafloor.

Contour Advancement. As with profile-matching, contour advancement does not require that significant features be present, but it is desirable to transit across a gently sloping area with slopes that are greater than one degree, but no more than four or five degrees. The area should also be well-charted, with moderately reliable contours.

To use the contour advancement technique to verify a position fix, a vessel must transit across an area at a constant bearing and speed, in line with the direction of a known slope. When the (singlebeam) echo sounder depth matches a charted contour depth, the navigator knows that the ship is somewhere on that charted depth contour - but precisely where is unknown. This first contour becomes the 'reference' contour, and is traced onto a transparent overlay that will be shifted (or advanced) on the chart as new contour depths are collected.

When the echo sounder indicates that the vessel has reached the next charted contour depth, the navigator moves the reference contour overlay forward to the new estimated position on the chart. The distance that the contour is advanced is determined by measuring the time it took to travel between observed

contour soundings, and multiplying that time by the vessel's constant speed.

Advancing the reference contour has the effect of moving every possibility of the ship's starting location on that first contour visually into the vicinity of the next contour (basically, offsetting every point on the first contour by the distance covered, without having to manually draw all of those infinite offset points). If executed accurately, the intersection of the advanced contour (i.e. the first contour, offset by the distance covered) and the next charted contour will note the true location of the ship, provided that there is only one intersection.

Multiple intersections of the reference and charted contours means that there is more than one possible position. The mariner must then continue the contour advancement process to determine which candidate is the true track.

In the Figure 2609, the solid lines are charted contours, and the dashed lines are the advancement of the initial reference contour. The ship's estimated track (which the navigator plots on the overlay, and could have started anywhere on the reference contour) is the dashed line perpendicular to the contours. The time between echo sounder observations of charted contour depths is annotated on each track. The ship's true position is shown on the right; it identifies the areas where the vessel crossed each of the contours, after the advanced contour indicated the points of intersection.

Typical accuracy for contour advancement is approximately one-quarter of the contour spacing of the chart.

Basic Rules of Thumb for Contour Advancing are as follows:

- An accurate bathymetric chart of the region being traversed is required.

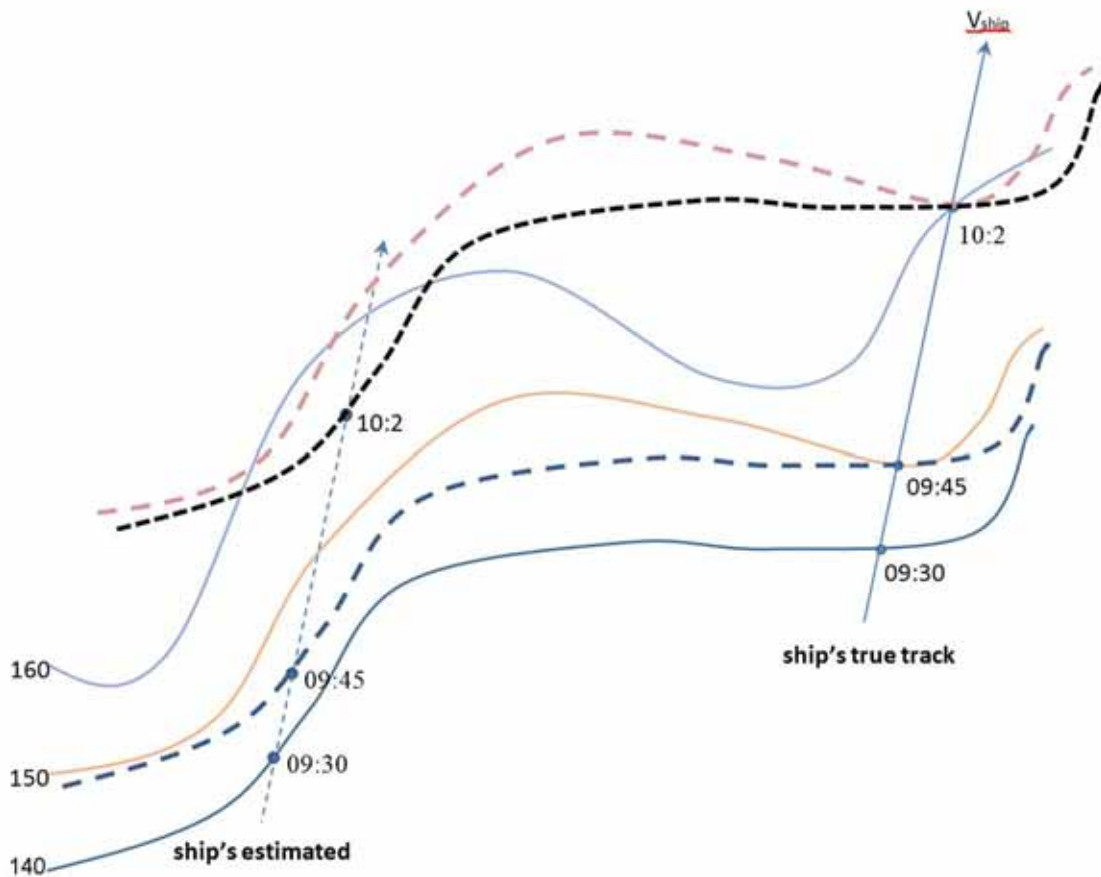

Figure 2609. The technique of contour advancing is illustrated in this figure. The isobaths shown in Figure 4 as solid lines are the contour lines on the chart; all dashed isobaths are results of contour advancement of the chart isobaths. Shown here for convenience is the true ship's position track, which is unknown to the navigator. The time of passage of the charted isobaths is also shown on the true track for convenience, more importantly, they are shown on the ship's estimated position track, which the navigator is plotting on the chart. Initially, the navigator traces the 140 isobath onto the overlay at 9:30 and establishes a reference point anywhere on the traced 140 isobath. Also note that this procedure can be performed after the fact if the times of passage, their charted depth, and the ship's velocity have been recorded for later use. When the next charted isobath, 150, is passed at 9:45, the navigator advances the overlay to the new estimated position. The advanced 140 isobath must intersect the charted 150 isobath at the ship's true location. If this is the only place of intersection of these two isobaths, the fix can be established at this time; the location of the intersection of the two isobaths is the ship's true position at 9:45. But there may be multiple locations of intersection, one of these is hinted at on the far right side of the displayed contours and perhaps one slightly to the left of the ship's estimated position. The advancement can then continue to the next charted isobath, 160, to help resolve the true location. In that case, the advanced 140 and 150 isobaths hint at possibly intersecting again at the far right, but the charted 160 isobath diverges from them there, and the location slightly to the left of the estimated ship's track doesn't show a strong three-way intersection like at the point on the true track at the point labeled 10:20, showing that the point labeled 10:20 on the true track would be the ship's true position at that time. The intersections may form a triangle instead of a point due to errors, the smaller the triangle, the better the confidence in the fix; or perhaps additional contours can be advanced to help resolve the fix if the error triangle is too large. Typical accuracy is on the order of ± 100 yards, or about one-quarter of the line spacing of the chart.

- Slopes should be between 1° to 4° (no more than 5°), and they should be varying; use of areas with constant slopes could result in intersections which are along lines, not at points, and so would not reveal precise location.
- Contour advancing is made easier by using the largest scale chart available, assuming the area is not absolutely flat. A given chart may not show any slope for a given area, but the area may show some relief on a larger chart.

2610. Line of Sounding Technique

Recovering a position fix using the line-of-soundings technique is similar to contour advancement, but usually requires collecting more observed depths to obtain an accurate fix. A vessel using a singlebeam echo sounder runs a single straight line over a charted area at a constant bearing and speed, and the sounding values that correspond to charted contours are plotted onto a trackline on a clear chart overlay. The line is then moved across the charted contours, until the plotted soundings match up with the charted contour interval. This provides a position fix. If a vessel is using a multibeam echo sounder, the

continuous swath of seafloor data can also be compared to the charted contours, to identify matching patterns with higher fidelity.

In Figure 2610, the red lines represent the singlebeam echo sounder trackline of plotted overlay soundings. The navigator moved this trackline across the charted contours, using the 500m contour as a central reference guide, until they found a match (the trackline in the center of the chart). Like other forms of bathymetric navigation, this method would not work in a very flat area, since the trackline would appear to match the depths in many directions.

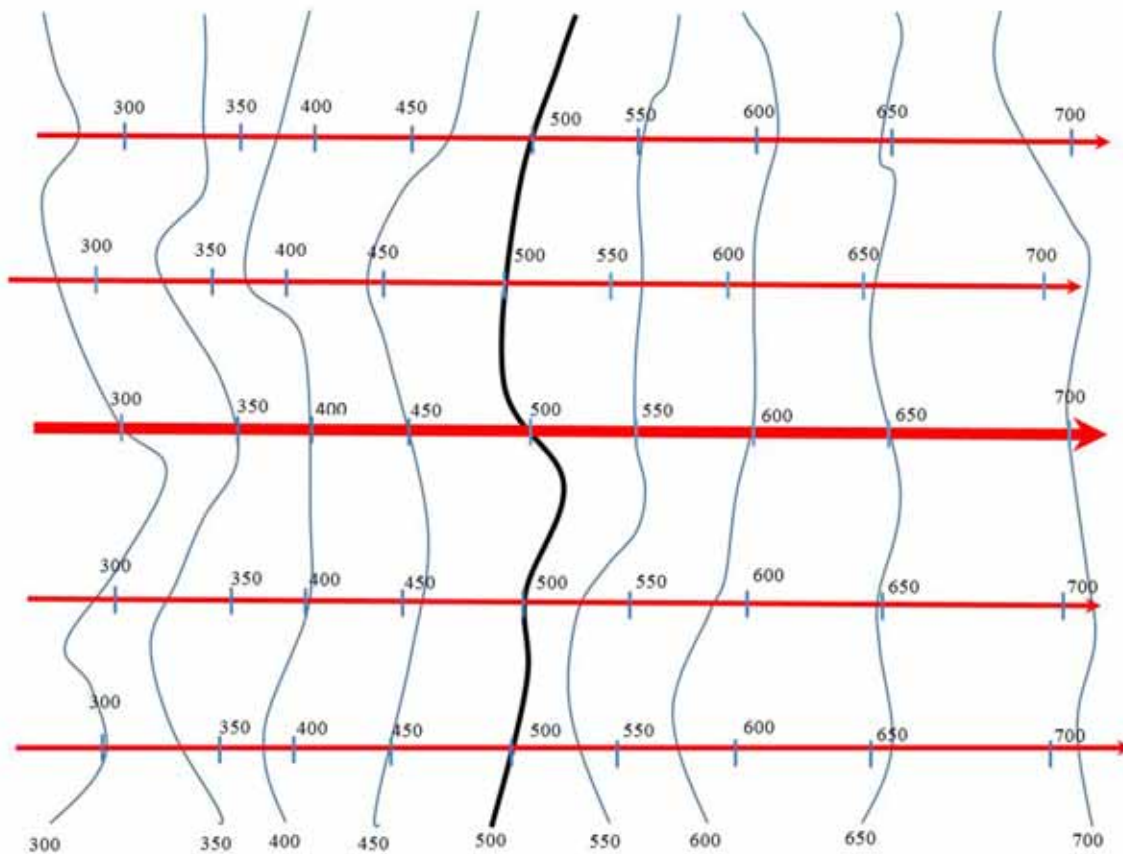

Figure 2610. Line of soundings technique. Image courtesy of Johns Hopkins University - Applied Physics Laboratory.

2611. Side Echo Technique

The side-echo technique is useful for determining position when traversing seamounts. For this method, the vessel must conduct at least two transit lines across the seamount, each of constant bearing and speed, offset from each other at right angles. The depth trend on each line indicates the quadrant location of the shoalest (shallowest) point of the seamount, relative to the intersection of the transit lines.

The navigator should plan the initial transit line so that

it approaches the seamount from a distance of at least 20 or 30 nautical miles. In deep water, this distance will help the navigator identify changes in seafloor relief and will help prevent missing the feature (the track should capture at least the base of a large feature, even if the shoalest point is missed). The vessel should maintain a constant course while approaching the seamount. If the vessel is using a singlebeam echosounder, the navigator should plot the depths at regular intervals (e.g. once per minute) while crossing the feature. The minimum depth should be noted and marked on the trackline.

Once the initial transit has crossed the feature, the vessel should run another transit line, exactly perpendicular to the first. The navigator should again plot the depths periodically, and annotate the point of least depth. If a line is then drawn between the shallowest point on each line, the point where they intersect indicates the quadrant of the shallowest point of the seamount. If the vessel is using a multibeam sonar, the overlapping swaths from each line should show a clear depth trend towards one quadrant, and could even capture the shoalest point of the feature.

Once the approximate location of the shallowest point of the seamount is determined, that location can be compared to the charted minimum depth, to provide a position location for the vessel. Additional lines, offset to the first two, could help to more precisely locate the shoalest points. However, it is important to note that the charted minimum depth of the seamount could be wrong; previous surveys or reports may have only crossed over one side of the seamount, instead of directly over the shallowest part, or the

horizontal positioning methods used at the time may have been inaccurate, and the seamount's location could be slightly incorrect (see Figure 2611b). Whenever possible, the mariner should try to select a feature that comes from a reliable source, such as a hydrographic survey.



Figure 2611a. Link to NGA's Maritime Safety Office - Contact Information.

https://msi.nga.mil/NGAPortal/MSI.portal?_nfpb=true&_st=&pageLabel=msi_contact_iufo

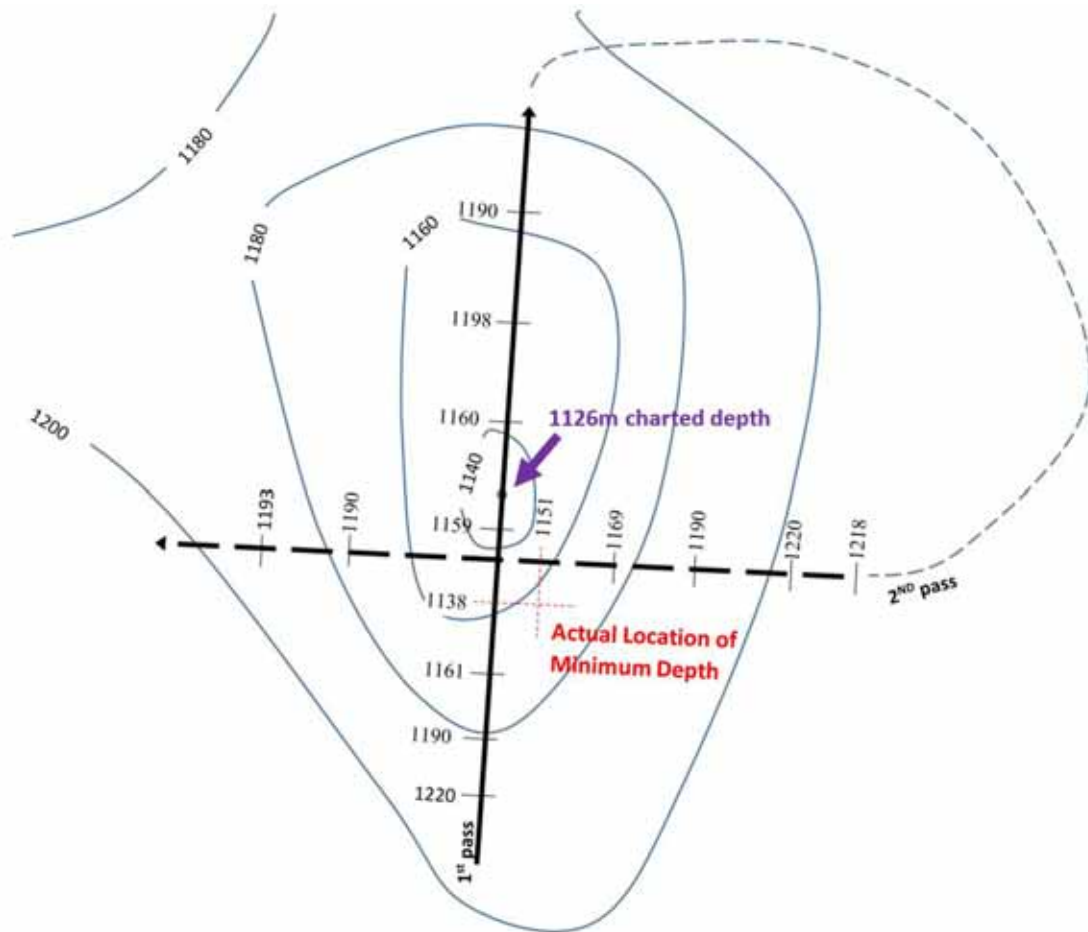

Figure 2611b. Side-echo bathymetric navigation. This image is provided courtesy of Johns Hopkins University- Applied Physics Laboratory.

If a mariner finds that the actual depth of the seamount is shallower than the charted least depth, that information should be reported to NGA's Maritime Safety Office as

soon as possible (see link in Figure 2611a), so that the chart can be updated.

2612. Computerized Techniques

Automated programs exist that can incorporate singlebeam or multibeam SONAR data, along with the speed and course of the vessel, and compare that data directly to digital features and chart contours. These programs can provide an approximate position fix without the need to manually overlay and plot soundings.

2613. References

Cohen, P M., (1970). *Bathymetric Navigation and Charting*. U.S. Naval Institute Press, Annapolis, MD.
Sections reprinted with permission.

Cutler, T J., (2003). *Dutton's Nautical Navigation*, 15th Edition. U.S. Naval Institute Press, Annapolis, MD.
Sections reprinted with permission.

CHAPTER 27

NAVIGATION PROCESSES

INTRODUCTION

2700. Understanding the Process of Navigation

Navigation is comprised of a number of different processes. Some are done in a set order, some randomly, some almost constantly, others only infrequently. It is in choosing using these processes that an individual navigator's experience and judgment are most crucial. Compounding this subject's difficulty is the fact that there are no set rules regarding the optimum employment of navigational systems and techniques. Optimum use of navigational systems varies as a function of the type of vessel, the quality of the navigational equipment on board, and the experience and skill of the navigator and all the team members.

For the watch officer, ensuring the ship's safety always takes priority over completing operational commitments and carrying out the ship's routine. Navigation is their primary responsibility. Any ambiguity about the position of the vessel which constitutes a danger must be resolved immediately. The best policy is to prevent ambiguity by using all the tools available and continually checking different sources of position information to see that they agree. This includes the routine use of several different navigational techniques, both as operational checks and to maintain skills which might be needed in an emergency. Any single navigational system constitutes a single point of

failure, which must be backed up with another source to ensure the safety of the vessel.

It is also the navigator's responsibility to ensure that they and all members of their team are properly trained and ready in all respects for their duties, and that they are familiar with the operation of all gear and systems for which they are responsible. The navigator must also ensure that all digital and/or hardcopy charts and publications are updated with information from the *Notice to Mariners*, and that all essential navigational gear is in operating condition.

Navigating a vessel is a dynamic process. Schedules, missions, and weather often change. Planning a voyage is a process that begins well before the ship gets underway. Executing that plan does not end until the ship ties up at the pier or drops anchor at its final destination. It is rarely possible to over plan a voyage, but it is a more serious error to under plan it. Carefully planning a route, preparing required charts and publications, and using various methods to monitor the ship's position as the trip proceeds are fundamental to safe navigation and are the marks of a professional navigator.

This chapter will examine navigational processes, the means by which a navigator manages all of the resources at their command to ensure a safe and efficient voyage.

BRIDGE RESOURCE MANAGEMENT

2701. The Navigator as Manager

The development of computers and navigational technologies driven by them has led to an evolution, some might say revolution, in the role of the navigator. Increasingly, the navigator is the manager of a combination of systems of varying complexity, which are used to direct the course of the ship and ensure its safety. The navigator is thus becoming less concerned with the direct control of the ship and more concerned with managing the systems and people which do so under their direction. While fundamental navigation skills remain vital, the navigator must become competent and comfortable with the management of advanced technology and human resources, especially in stressful situations.

A modern ship's navigational suite might include an integrated bridge system with a comprehensive fleet and

voyage management software package and an ECDIS or ECS system that may replace the ship's paper charts. Many systems can be integrated with the charting systems including AIS, radar overlay, dual interswitched X- and S-band ARPA radars, track or heading control, digital flux gate and ring laser gyrocompasses, GPS/DGPS positioning systems, numerous environmental sensors, a digital depth sounder and a Doppler speed log. The communications suite might include a GMDSS workstation with a NAVTEX receiver, a computer weather routing system, a SATCOM terminal, several installed and portable VHF radios, a closed circuit television system, a public address and alarm system and automated systems controlling cargo and machinery operations. With all this technology coming aboard, crew size is decreasing, placing increased responsibility on each member of the team.

Thus, the modern navigator is becoming a manager of

these resources, both electronic and human. Of course, they have always been so, but today's systems are far more complex and the consequences of a navigational error are far more serious than ever before. The prudent navigator will therefore be familiar with the techniques of Bridge Resource Management (BRM), by which they can supervise the numerous complex tasks involved with maintaining navigational control of their vessel.

Bridge Team Management refers to the management of the human resources available to the navigator—helmsman, lookout, engine room watch, etc.—and how to ensure that all members contribute to the goal of a safe and efficient voyage.

Bridge Resource Management (BRM) is the study of the resources available to the navigator and the exploitation of them in order to conduct safe and efficient voyages. The terms “bridge resource management” and “bridge team management” are not precisely defined. For most, bridge resources consist of the complete suite of assets available to the navigator including electronic and human, while bridge team management refers only to human assets, except for the pilot, who is normally not considered a member of the team.

The resources available will vary according to the size of the ship, its mission, its crew, its shoreside management, funding, and numerous other variables. No two vessels are alike in resources, for even if two ships of a single class are alike in every physical respect, the people who man them will be different, and people are the most important resource the navigator has.

Effective Bridge Resource Management requires:

- Clearly defined navigational goals
- Defined procedures—a system—for achieving goals
- Means to achieve the goals
- Measures of progress toward goals
- Constant awareness of the situation tactically, operationally, and strategically
- Clearly defined accountability and responsibility
- Open communication throughout the system
- External support

2702. Watch Conditions

Whenever the navigational situation demands more resources than are immediately available to the navigator, a dangerous condition exists. This can be dealt with in two ways. First, the navigator can call up additional resources, such as by adding a bow lookout or an additional watch officer. Second, they can lower the navigational demands to the point where their available resources are able to cope, perhaps by reducing speed, changing course, heaving to, or anchoring.

Some conditions that increase the demands on the navigator include:

- Fog

- Heavy traffic
- Entering a channel, harbor or restricted area
- Heavy weather
- Fire, flooding, or other emergency

These and many other situations can increase the demands on the time and energy of the navigator, and cause them to need additional resources—another watch officer, a bow lookout, a more experienced helmsman—to take some of the workload and rebalance the amount of work to be done with the people available to do it.

There is no strict legal direction as to the assignment of personnel on watch. Various rules and regulations establish certain factors which must be addressed, but the responsibility for using the available people to meet them rests with the watch officer. Laws and admiralty cases have established certain requirements relating to the position and duties of the lookout, safe speed under certain conditions, mode of steering, and the use of radar. The maritime industry has established certain standards known as **Watch Conditions** to help define the personnel and procedures to be used under various situations:

Watch Condition I indicates unrestricted maneuverability, weather clear, little or no traffic, and all systems operating normally. In this condition, depending on the size and type of vessel and its mission, often a single licensed person can handle the bridge watch.

Watch Condition II applies to situations where visibility is somewhat restricted, and maneuverability is constrained by hydrography and other traffic. This condition may require additional navigational resources, such as a lookout, helmsman, or another licensed watch officer.

Watch Condition III reflects a condition where navigation is seriously constrained by poor visibility, close quarters (as in bays, sounds, or approach channels), and heavy traffic.

Watch Condition IV is the most serious, occurring when visibility is poor, maneuvering is tightly constrained (as in channels and inner harbors), and traffic is heavy.

Any watch condition can change momentarily due to planned or unforeseen events. Emergency drills or actual emergencies on one's own or other nearby vessels can quickly overwhelm the unprepared bridge team. Prudent navigators predict these events, develop plans and train their crews to respond to these events. Training and eternal vigilance are essential to meet unexpected demands.

Under each of these conditions, the navigator must manage their resources effectively and efficiently, calling

in extra help when necessary, assigning personnel as needed to jobs for which they are qualified and ready to perform. The navigator must consider the peculiarities of the ship and its people, including considerations of vessel design and handling characteristics, personalities and qualifications of individuals, and the needs of the situation.

2703. Laws Relating to Bridge Resources

Numerous laws and regulations relate to the navigation of ships, particularly in less than ideal conditions. Title 33 of the Code of Federal Regulations (CFR) specifies bridge visibility parameters. Title 46 CFR and IMO standards relate to medical fitness. Public Law 101-380 specifies the maximum hours of work permitted, while 46 CFR specifies the minimum hours of rest required. Competency and certification are addressed by 46 CFR and STCW. Charts, publications, and navigational equipment are the subject of 33 CFR, which also specifies tests required before getting underway and the conduct of ships to prevent collision. This code also requires reporting of certain dangerous conditions aboard the vessel.

Various U.S. state and local regulations also apply to the duties and responsibilities of the bridge team, and numerous regulations and admiralty case law relate indirectly to bridge resource management.

2704. Pilots

One of the navigator's key resources in the harbor and harbor approaches is the pilot, a professional shiphandler with encyclopedic knowledge of a local port and harbor area. Their presence is generally required by local regulation or law. The pilot is not considered, by the common definition, to be a member of the bridge team, but is an extremely important bridge resource and is expected to develop and maintain a cooperative, mutually supportive working relationship with the master and bridge crew. While the pilot is engaged in pilotage duties aboard a vessel in compulsory pilotage waters, the pilot directs the navigation of the vessel, subject to the master's overall command of the ship and the ultimate responsibility for its safety. In this respect, the navigation of the ship in compulsory pilotage waters is a shared responsibility between the pilot and the master/bridge team.

As an important navigational resource, the bridge team should monitor the pilot, and as a professional navigator, the pilot deserves respect. The balance of these two elements is the responsibility of the captain, who manages the **Master-Pilot Exchange (MPX)** for the vessel.

The explicit purpose of the MPX, which is a two-way exchange of information, is for the pilot to provide information about the port and the route to be followed and for the captain to inform the pilot of the particulars of the ship: its draft, condition of engines and navigational equipment and special conditions or characteristics which

might affect the ship's close quarters handling. However, simply relating the ship's characteristics and condition does not constitute a proper MPX, which must be more comprehensive.

The implicit purpose of the MPX is to establish an appropriate working relationship between the captain and the pilot, which recognizes that each has an important role in the safe navigation of the vessel. It ensures the agreed upon mental model of the transit is shared with the bridge team. Thus, the MPX is not an event but a process, which will ensure that everyone responsible for navigating the vessel shares the same plan for the transit.

Some ships prepare a pilot card that lists the essential vessel parameters for the pilot's ready reference. The pilot may also use an MPX card to ensure that all required areas of concern are covered. The pilot may or may not require a signature on his own form, and may or may not be requested or allowed to sign ship's forms. These are matters of local law and custom that must be respected.

Often, among the pilot's first words upon boarding will be a recommendation to the captain to take up a certain course and speed. The captain then gives the appropriate orders to the bridge team. As the vessel gathers way, the rest of the MPX can proceed. As time permits, the pilot can be engaged in conversation about the events and hazards to be expected during the transit, such as turning points, shoal areas, weather and tides, other ship traffic, tugs and berthing arrangements, status of ground tackle, and other matters of concern. This information should be shared with the bridge team. At any time during the transit, the captain should bring up matters of concern to the pilot for discussion. Communication is the vital link between pilot and master that ensures a safe transit.

2705. Managing the Bridge Team

Shipboard personnel organization is among the most hierarchical to be found. Orders are given and expected to be obeyed down the chain of command without hesitation or question, especially in military vessels. While this operational style defines responsibilities clearly, it does not take advantage of the entire knowledge base held by the bridge team, which increasingly consists of a number of highly trained people with a variety of skills, abilities, and perceptions.

While the captain may have the explicit right to issue orders without discussion or consultation (and in most routine situations it is appropriate to do so), in unusual, dangerous, and stressful situations, it is often better to consult other members of the team. Communication, up and down, is the glue that holds the bridge team together and ensures that all resources are effectively used. Many serious groundings could have been prevented by the simple exchange of information from crew to captain, information which, for reasons of tradition and mindless obedience to protocol, was not shared or was ignored.

A classic case of failure to observe principles of bridge team management occurred in 1950 when the USS Missouri, fully loaded and making over 12 knots at high tide, grounded hard on Thimble Shoals in Chesapeake Bay. The Captain ignored the advice of his Executive Officer, berated the helmsman for speaking out of turn, and failed to order a right turn into Thimble Shoals Channel. It took more than two weeks to free the ship.

Most transportation accidents are caused by human error, usually resulting from a combination of circumstances, and almost always involving a communications failure. Analysis of numerous accidents across a broad range of transportation fields reveals certain facts about human behavior in a dynamic team environment:

- Better decisions result from input by many individuals
- Success or failure of a team depends on their ability to communicate and cooperate
- More ideas present more opportunities for success and simultaneously limit failure
- Effective teams can share workloads and reduce stress, thus reducing stress-related errors
- All members make mistakes; no one has all the right answers
- Effective teams usually catch mistakes before they happen, or soon after, and correct them

These facts argue for a more inclusive and less hierarchical approach to bridge team management than has been traditionally followed. The captain/navigator should include input from bridge team members when constructing the passage plan and during the pre-voyage conference, and should share his views openly when making decisions, especially during stressful situations. They should look for opportunities to instruct less experienced team members by involving them in debate and decisions regarding the voyage. This ensures that all team members know what is expected and share the same mental model of the transit.

Effective bridge teams do not just happen. They are the result of planning, education, training, practice, drills, open communication, honest responses, and management support. All of these attributes can and should be taught, and a number of professional schools and courses are dedicated to this subject. See Figure 2705 for a link to U.S. Coast Guard approved courses such as Bridge Resource Management and other subjects that will help the navigator manage resources effectively.

2706. Standards of Training, Certification, and Watchkeeping (STCW)

The International Maritime Organization's (IMO) In-



Figure 2705. Link to USCG list of courses search engine. <https://www.uscg.mil/nmc/courses/default.asp?tab=0#TabbedPanels1>

ternational Convention on Standards of Training, Certification and Watchkeeping for Seafarers (STCW) of 1978 set qualification standards for masters, mates, and ratings. It entered into force in 1984, and the United States became a party to this convention in 1991.

Between 1984 and 1992, significant limitations to the 1978 conventions became apparent. Vague requirements, lack of clear standards, limited oversight and control, and failure to address modern issues of watchkeeping were all seen as problems meriting a review of the 1978 agreement. This review was to concentrate on the *human element*, which in fact is the cause of most marine casualties. Three serious maritime casualties, in which human factors played a part, spurred the IMO to expedite this review and update the STCW Convention and Code. This work commenced in 1995 and was subsequently entered into force on February 1, 1997. The STCW Convention and its associated Code, have been amended several times since then, most recently in 2010, resulting in improvements in mariner qualifications.

The provisions of the STCW address the human element of bridge resource management. They mandate maximum working hours, minimum rest periods, and training requirements for specific navigational and communications systems such as ECDIS, ARPA and GMDSS. They require that officers understand and comply with the principles of bridge resource management. They require not merely that people be trained in certain procedures and operations, but that they *demonstrate competence* therein.

The navigational competencies for deck ratings relate to general watchstanding duties. Such personnel must not only complete training, but must demonstrate competency in the use of magnetic and gyro-compasses for steering and course changes, response to standard helm commands, change from automatic to hand steering and back, responsibilities of the lookout, and proper watch relief procedures.

Competence may be demonstrated by various methods either at sea, as part of an approved course, or in approved simulators, and must be documented by Qualified Assessors (QA's).

VOYAGE PLANNING

2707. The Passage Plan

Before each voyage begins, the navigator should develop a detailed mental model of how the entire voyage is to proceed sequentially, from getting underway to mooring. This mental model will include charting courses, forecasting the weather and tides, checking *Sailing Directions* and *Coast Pilots*, and projecting the various future events—landfalls, narrow passages, and course changes—that will transpire during the voyage. This mental model becomes the standard by which they will measure progress toward the goal of a safe and efficient voyage, and

it is manifested in a passage plan. See Figure 2707 for a graphic depicting a systems approach to passage planning.

The passage plan is a comprehensive, step by step description of how the voyage is to proceed from berth to berth, including undocking, departure, enroute, approach and mooring at the destination. The passage plan should be communicated to the navigation team in a pre-voyage conference in order to ensure that all members of the team share the same mental model of the entire trip. This differs from the more detailed piloting brief discussed in Chapter 10, though it may be held in conjunction with it, and may be a formal or informal process.

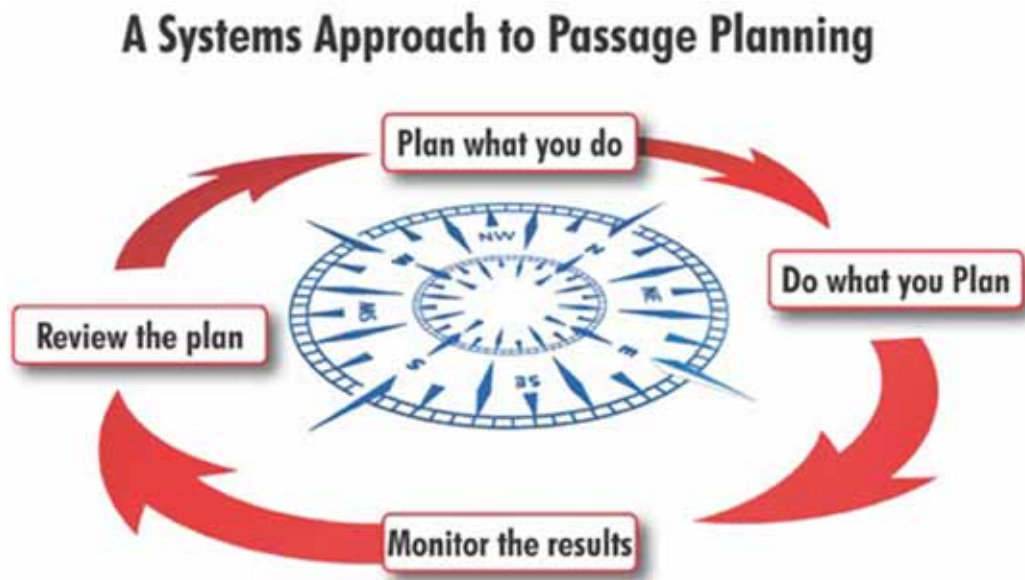

Figure 2707. Passage planning model.

Some COLREG rules leave room for masters and bridge teams to interpret their execution. For example, the close proximity of a passing vessel or the distance that a give-way vessel must clear a stand-on vessel is not defined and differences of opinion must be addressed. One watch officer might consider a one mile minimum passing distance appropriate, while the captain prefers to pass no closer than two miles. These kinds of differences must be reconciled before the voyage begins, and the passage plan is the appropriate forum in which to do so.

Thus, each member of the navigation team will be able to assess the vessel's situation at any time and make a judgment as to whether or not additional bridge resources are necessary. Passage planning procedures are specified in Title 33 of the U.S. Code, IMO Resolutions, and a number of professional books and publications. There are some fifty elements of a comprehensive passage plan depending on the size and type of vessel, each applicable according to the individual situation.

Passage planning software can greatly simplify the

process and ensure that nothing important is overlooked. A good passage planning software program will include great circle waypoint/distance calculators, tide and tidal current predictors, celestial navigational calculators, consumables estimators for fuel, oil, water, and stores, and other useful applications.

As the voyage proceeds, the navigator must maintain situational awareness to continually assess the progress of the ship as measured against the passage plan and the mental model of the voyage. Situational awareness consists of perceiving, comprehending, and comparing what is known at any given time with the mental model and passage plan. Both individual and team situational awareness are necessary for a safe voyage, and the former must be established by all members of the bridge team before the latter is possible.

The enemies of situational awareness are complacency, ignorance, personal bias, fatigue, stress, illness, and any other condition which prevents navigators and their team members from clearly seeing and assessing

the situation.

2708. Constructing a Voyage Track

Coastwise passages of a few hundred miles or less can be laid out directly on charts, either electronic or paper. Over these distances, it is reasonable to ignore great circle routes and plot voyages directly on Mercator charts.

For trans-oceanic voyages, construct the track using a navigational computer, a great circle (gnomonic) chart, or a sailing chart. It is best to use a navigational computer or calculator if one is available to save time and to eliminate the plotting errors inherent in transferring the track from a gnomonic to a Mercator projection. Because they solve problems mathematically, computers and calculators also eliminate rounding errors inherent in the tables, providing more accurate solutions.

To use a navigational computer for voyage planning, navigators simply enter the two endpoints of their planned voyage or major legs thereof in the appropriate spaces. The program may ask for track segment intervals every X number of degrees. It then computes waypoints along the great circle track between the two endpoints, determines each track leg's distance and, given a speed of advance, calculates the time the vessel can expect to pass each waypoint. The waypoints may be saved as a route, viewed on screen, and sent to the autopilot. On paper charts, construct the track on an appropriate Mercator chart by plotting the computer-generated waypoints and the tracks between them.

After adjusting the track as necessary to pass well clear of any hazard, choose a **speed of advance (SOA)** that ensures the ship will arrive on time at its destination or at

any required point. Various factors including scheduled deliveries, rendezvous plans, weather avoidance, fuel efficiency and others can contribute to a planned SOA. If the time of arrival is open-ended, that is, not specifically required, choose a reasonable average SOA. Given an SOA, mark the track with the vessel's first few planned hourly positions. In the Navy, these planned positions are **points of intended movement (PIM)**. The SOA chosen for each track leg is the PIM speed. Merchant vessels usually refer to them as waypoints.

An operation order often assigns a naval vessel to an operating area. In that case, plan a track from the departure to the edge of the operating area to ensure that the vessel arrives at the operating area on time. Following a planned track inside the assigned area may be impossible because of the dynamic nature of an exercise. In that case, carefully examine the entire operating area for navigational hazards. If simply transiting through the area, the ship should still follow a planned and approved track.

2709. Following a Voyage Plan

Complete the planning discussed in section 2708 prior to leaving port. Once the ship is transiting, frequently compare the ship's actual position to the planned position and adjust the ship's course and speed to compensate for any deviations. Order courses and speeds to keep the vessel on track without significant deviation.

Often, a vessel will have its operational commitments changed after it gets underway. If this happens, it will be necessary to begin the voyage planning process anew.

VOYAGE PREPARATION

2710. Equipment Inventory

Prior to getting the ship underway, the navigator should inventory all navigational equipment, charts, and publications. They should develop a checklist of navigational equipment specific to the vessel and check that all required equipment is onboard and in operating order. The navigator should have all applicable *Sailing Directions*, pilot charts, and navigation charts covering the planned route. They should also have all charts and *Sailing Directions* covering ports at which the vessel may call. They should have all the equipment and publications required to support all appropriate navigational methods. Finally, they must have all technical documentation required to support the operation of the electronic navigation suite. Much of this information may be carried electronically.

It is important to complete this inventory well before the departure date and obtain all missing items before sailing.

2711. Chart Preparation

Just as the navigator must prepare charts for piloting, they must also prepare their small scale charts for an open ocean transit. The following is the minimum chart preparation required for an open ocean or offshore coastal transit. The charts should be reviewed by the vessel master and/or pilot (if taken).

Correcting the Chart: Correct all applicable charts through the latest *Notice to Mariners*, *Local Notice to Mariners*, and Broadcast Notice to Mariners. Ensure the chart to be used is the latest announced edition. If electronic charts are used, ensure the latest chart corrections have been downloaded and that the charting software is installed with the latest manufacturer update.

Plotting the Track: Mark the track course above the track line with a "C" followed by the course. Similarly, mark each track leg's distance under the course line with a

“D” followed by the distance in nautical miles. Figure 2711

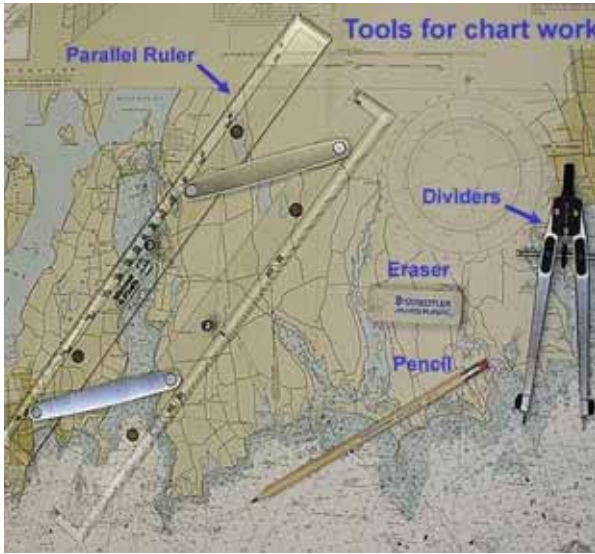

Figure 2711. Typical tools used when navigating on paper charts include a pair of dividers, parallel ruler, eraser and pencil.

depicts some of the plotting tools used when navigating on paper charts.

Calculating Minimum Expected, Danger, and Warning Soundings: Chapter 10 discusses calculating minimum expected, danger and warning soundings. Determining these soundings is particularly important for

ships passing a shoal close aboard. Set these soundings to warn the conning officer that they are passing close to the shoal. Mark the minimum expected sounding, the warning sounding, and the danger sounding clearly on the chart and indicate the section of the track for which they are applicable.

Marking Allowed Operating Areas: (Military vessels) Often an operation order assigns a naval vessel to an operating area for a specific period of time. There may be operational restrictions placed on the ship while within this area. For example, a surface ship assigned to an operating area may be ordered not to exceed a certain speed for the duration of an exercise. When assigned an operating area, clearly mark that area on the chart. Label it with the time the vessel must remain in the area and what, if any, operational restrictions it must follow. The conning officer and the captain should be able to glean the entire navigational situation from the chart alone without reference to the directive from which the chart was constructed. Therefore, put all operationally important information directly on the chart.

Marking Chart Shift Points: Mark the chart points where the navigator must shift to the next chart, and note the next chart number.

Examining Either Side of Track: Highlight any shoal water or other navigational hazard near the planned track. This will alert the conning officer as they approach a possible danger.

VOYAGE MONITORING

2712. Fix Frequency

The Coast Guard has allowed ECDIS and specific electronic chart systems (ECS) to meet the chart carriage requirement of CFR Title 33. If ECDIS or ENC is in use, fix frequency is not an issue. The ship’s position will be displayed on the chart continuously and the navigator need only monitor the process. If only a chart plotter is available, more careful attention is necessary since a chart plotter cannot substitute for paper charts as ECDIS does. Nevertheless, it is reasonable to plot fixes at less frequent intervals when using a chart plotter, checking the system with a hand-plotted fix at prudent intervals.

Assuming that an electronic chart system is not available and hand-plotted fixes are the order of the day, adjust the fix interval to ensure that the vessel remains at least two fixes from the nearest danger. Choose a fix interval that provides a sufficient safety margin from all charted hazards.

Table 2712 below lists recommended fix intervals as a function of the phase of navigation:

	Harbor/Appr.	Coastal	Ocean
Frequency	3 min. or less	3-15 min.	30 min.

Table 2712. Recommended fix intervals.

Use all available fix information. With the advent of accurate satellite navigational systems, it is especially tempting to disregard this maxim. However, the experienced navigator never feels comfortable relying solely on one particular system. Supplement the satellite position with celestial fixes, radar lines of position, soundings, or visual observations. Evaluate the accuracy of the various fix methods against the satellite position.

Use an inertial navigator if one is available. The inertial navigator may actually produce estimated positions more accurate than non-GPS based fix positions. Inertial navigators are completely independent of any external input. Therefore, they are invaluable for maintaining an accurate ship’s position during periods

when external fix sources are unreliable or unavailable.

Always check a position determined by a fix, inertial navigator, or DR by comparing the charted sounding at the position with the fathometer reading. If the soundings do not correlate, investigate the discrepancy.

Chapter 9 covers the importance of maintaining a proper DR. It bears repeating here. Determine the difference between the fix and the DR positions at every fix and use this information to calculate an EP from every DR. Constant application of set and drift to the DR is crucial if the vessel must pass a known navigational hazard close aboard.

2713. Fathometer Operations

While the science of hydrography has made tremendous advances in recent years, these developments have yet to translate into significantly more accurate soundings on charts. Further, mariners often misunderstand the concept of an electronic chart, erroneously thinking that the conversion of a chart to electronic format indicates that updated hydrographic information has been used to compile it. This is rarely the case. Newly compiled chart data still may be based on sounding databases, which in some cases are more than a century old.

While busy ports and harbors tend to be surveyed and dredged at regular intervals, in less traveled areas it is common for the navigator to find significant differences between the observed and charted soundings. If in doubt about the date of the soundings, refer to the title block of the chart, where information regarding the data used to compile it may be found.

Standardized rules and procedures for the use of the depth sounder are advisable and prudent. Table 2713 suggests a set of guidelines for depth sounder use on a typical ship.

Water Depth	Sounding Interval
< 10 m	Monitor continuously.
10 m - < 100 m	Every 15 minutes.
100 m - < 300 m	Every 30 minutes.
> 300 m	Every hour.

Table 2713. Fathometer operating guidelines.

2714. Compass Checks

Determine gyro compass error at least once daily and before each transit of restricted waters. Check the gyro compass reading against the inertial navigator if one is installed. If the vessel does not have an inertial navigator, check gyro error using a flux gate magnetic or ring laser gyro compass, or by using the celestial techniques

discussed in Chapter 15.

The magnetic compass, if operational, should be adjusted regularly and a deviation table prepared and posted as required (see Chapter 8). If the magnetic compass has been deactivated in favor of a digital flux gate magnetic, ring laser gyro, or other type of electronic compass, the electronic compass should be checked to ensure that it is operating within manufacturer's specifications, and that all remote repeaters are in agreement. Note that the electronic compass must not be in the ADJUST mode when in restricted waters.

2715. Real Time Navigation Data

With the advent of electronic navigation, mariners have access before and during transits to real time observations, forecasts and other geospatial information. This data, accessed through various channels (AIS, NAVTEX, or internet connection) can increase mariner situational awareness and navigation safety. Available data includes tides, currents, water levels, salinity, winds, atmospheric pressure, air and water temperatures.

2716. Night Orders and Standing Orders

The Night Order Book is the vehicle by which the captain informs the officer of the deck of their orders for operating the ship. It may be in hardcopy or electronic format. The Night Order Book, despite its name, can contain orders for the entire 24 hour period for which the Captain or Commanding Officer issues it.

The navigator may write the Night Orders pertaining to navigation. Such orders include assigned operating areas, maximum speeds allowed, required positions with respect to PIM or DR, and, regarding submarines, the maximum depth at which the ship can operate. Each department head should include in the Night Order book the evolutions they want to accomplish during the night that would normally require the captain's permission. The captain can add further orders and directions as required.

The Officer of the Deck or mate on watch must not follow the Night Orders blindly. Circumstances under which the captain signed the Orders may have changed, rendering some evolutions impractical or impossible. The Officer of the Deck, when exercising their judgment on completing ordered evolutions, must always inform the captain of any deviation from the Night Orders as soon as such a deviation occurs.

While Night Orders are in effect only for the 24 hours after they are written, Standing Orders are continuously in force. The captain sets the ship's navigation policy in these orders. They set required fix intervals, intervals for fathometer operations, minimum CPA's, and other general navigation and collision avoidance requirements.

2717. Watch Relief Procedures

When a watch officer relieves as Officer of the Deck or mate on watch, they assume the responsibility for the safe navigation of the ship. They become the Captain's direct representative, and is directly responsible for the safety of the ship and the lives of its crew. They must prepare themselves carefully prior to assuming these responsibilities. A checklist developed specifically for each vessel can serve as a reminder that all watch relief procedures have been followed. The following list contains those items that, as a minimum, the relieving watch officer must check prior to assuming the navigation watch.

- **Conduct a Pre-Watch Tour:** The relieving watch officer should tour the ship prior to their watch. They should familiarize themselves with any maintenance in progress, and check for general cleanliness and stowage. They should see that any loose gear that could pose a safety hazard in rough seas is secured.
- **Check the Position Log and Chart:** Check the type and accuracy of the ship's last fix. Verify that the navigation watch has plotted the last fix properly. Ensure there is a properly constructed DR plot on the chart. Examine the DR track for any potential navigational hazards. Check ship's position with respect to the PIM or DR. Ensure that the ship is in the correct operating area, if applicable. Check to ensure that the navigation watch has properly applied fix expansion if necessary.
- **Check the Fathometer Log:** Ensure that previous watches have taken soundings at required intervals and that the navigation watch took a sounding at the last fix. Verify that the present sounding matches the charted sounding at the vessel's position.
- **Check the Compass Record Log:** Verify that the navigation watch has conducted compass checks at the proper intervals. Verify that gyro error is less than 1° and that all repeaters agree within 1° with the master gyro.
- **Read the Night Orders:** Check the Night Order Book for the captain's directions for the duration of the watch.
- **Check Planned Operations and Evolutions:** For any planned operations or evolutions, verify that the ship meets all prerequisites and that all watchstanders have reviewed the operation order or plan. If the operation is a complicated one, consider holding an operations brief with applicable watchstanders prior to assuming the watch.
- **Check the Broadcast Schedule:** Read any message traffic that could have a bearing on the upcoming watch. Find out when the last safety and

operational messages were received. Determine if there are any required messages to be sent during the watch (e.g. position reports, weather reports, AMVER messages).

- **Check the Contact Situation:** Check the radar picture (and sonar contacts if so equipped). Determine which contact has the nearest CPA and what maneuvers, if any, might be required to open the CPA. Find out from the off-going watch officer if there have been any bridge-to-bridge communications with any vessels in the area. Check that no CPA will be less than the minimum set by the Standing Orders.
- **Review Watchstander Logs:** Review the log entries for all watchstanders. Note any out-of-specification readings or any trends in log readings indicating that a system will soon fail.

After conducting these checks, the relieving watch officer should report that they are ready to relieve the watch. The watch officer should brief the relieving watch officer on the following:

- Present course and speed
- Present depth (submarines only)
- Evolutions planned or in progress
- Status of the engineering plant
- Status of any out-of-commission equipment
- Orders not noted in the Night Order Book
- Status of cargo
- Hazardous operations planned or in progress
- Routine maintenance planned or in progress
- Planned ship's drills
- Any individuals working aloft, or in a tank or hold
- Any tank cleaning operations in progress

If the relieving watch officer has no questions following this brief, they should relieve the watch and announce to the rest of the bridge team that they have the deck and the conn. The change of watch should be noted in the ship's deck log.

Care should be taken when bridge team members relieve their perspective posts. Many distractions arise during watch relief and extra precautions should be taken in order to mitigate these risks. At times, staggering the watch relief of multiple watchstanders can provide continuity. Conversely, a unified relief may be the most efficient means to safely transfer the watch. Watch officers should not relieve the watch in the middle of an evolution, when making passing arrangement with another vessel or when casualty procedures are being carried out. This ensures watchstander continuity when carrying out a specific evolution. Alternatively, the on-coming watch officer might relieve only the conn, leaving the deck watch with the off-going officer until the situation is resolved.

2718. Bridge Navigational Watch & Alarm System

The **Bridge Navigational Watch & Alarm System (BNWAS)** is a monitoring and alarm system, which notifies other watch officers or the master of the ship if the officer on watch does not respond or becomes incapacitated while on duty.

A series of alerts and alarms are first sounded by

BNWAS, on the bridge or wheelhouse, to alert the officer on watch. If there is no response to the alarms, then the system will alert other deck officers, which may include the master, so that someone can come up to the bridge and investigate the situation.

The BNWAS must be operational when a vessel is heading on a voyage unless the master decides otherwise.

CHAPTER 28

EMERGENCY NAVIGATION

BASIC TECHNIQUES OF EMERGENCY NAVIGATION

2800. Planning for Emergencies

Increasing reliance on electronic navigation and communication systems has dramatically changed the perspective of emergency navigation. While emergency navigation once concentrated on long-distance lifeboat navigation, today it is far more likely that navigators will suffer failure of their ship's primary electronic navigation systems than that they will be forced to navigate a lifeboat. In the unlikely event they must abandon ship, their best course of action is to remain as close to the scene as possible, for this is where rescuers will concentrate their search efforts. Leaving the scene of a disaster radically decreases the chance of rescue, and there is little excuse for failure to notify rescue authorities with worldwide communications and maritime safety systems available at little cost. See Chapter 30 on Maritime Safety Systems for further discussion of these systems.

In the event of failure or destruction of electronic systems when the vessel itself is not in danger, navigational equipment and methods may need to be improvised. This is especially true with ECDIS and electronic charts. Navigators of a paperless ship, whose primary method of navigation is ECDIS, must assemble enough backup paper charts, equipment, and knowledge to complete their voyage in the event of a major computer system failure. Navigators who keep a couple of dozen paper charts and a spare handheld GPS receiver under their bunk will be heroes in such an event. If they have a sextant and celestial calculator or tables and the knowledge to use them, so much the better.

No navigator should ever become completely dependent on electronic methods. The navigator who regularly navigates by blindly pushing buttons and reading the coordinates from "black boxes" will not be prepared to use basic principles to improvise solutions in an emergency.

For offshore voyaging, professional navigators should become thoroughly familiar with the theory and practice of celestial navigation. They should be able to identify the most useful stars and know how to solve various types of sights. They should be able to construct a plotting sheet with a protractor and improvise a sextant. They should know how to solve sights using tables or a navigational calculator. For the navigator prepared with such knowledge the situation is never hopeless. Some method of navigation is always available to one who understands certain basic

principles.

The modern ship's regular suite of navigation gear consists of many complex electronic systems. Though they may possess a limited backup power supply, most depend on an uninterrupted supply of ship's electrical power. The failure of that power due to breakdown, fire, or hostile action can instantly render the unprepared navigator helpless. This discussion is intended to provide the navigator with the information needed to navigate a vessel in the absence of the regular suite of navigational gear. Training and preparation for a navigational emergency is essential; this should consist of regular practice in the techniques discussed herein.

2801. Emergency Navigation Kit

The navigator should assemble a kit containing equipment for emergency navigation. This kit should contain:

1. At least one proven and personally tested hand-held GPS receiver with waypoints and routes entered, and with plenty of spare batteries.
2. A small, magnetic hand-bearing compass such as is used in small craft navigation, to be used if all other compasses fail.
3. A minimal set of paper charts for the voyage at hand, ranging from small-scale to coastal to approach and perhaps harbor, for the most likely scenarios. A *pilot chart* for the ocean basin in question makes a good small scale chart for offshore use.
4. A notebook or journal suitable for use as a deck log and for computations, plus maneuvering boards, graph paper, and position plotting sheets.
5. Pencils, erasers, a straightedge, protractor or plotter, dividers and compasses, and a knife or pencil sharpener.
6. A timepiece. The optimum timepiece is a quartz crystal chronometer, but any high-quality digital wristwatch will suffice if it is synchronized with the ship's chronometer. A portable radio capable of receiving time signals, together with a good wristwatch, will also suffice.
7. A marine sextant. (An inexpensive plastic sextant will suffice.) Several types are available commercially.

The emergency sextant should be used periodically so its limitations and capabilities are fully understood.

8. A celestial navigation calculator and spare batteries, or a current *Nautical Almanac* and this book or a similar text. Another year's almanac can be used for stars and the Sun without serious error by emergency standards. Some form of long-term almanac might be copied or pasted in the notebook.
9. Tables. Some form of table might be needed for reducing celestial observations if the celestial calculator fails. The *Nautical Almanac* produced by the U.S. Naval Observatory contains detailed procedures for calculator sight reduction and a compact *sight reduction table*.
10. Flashlight. Check the batteries periodically and include extra batteries and bulbs in the kit.
11. Portable radio. A handheld VHF transceiver approved by the Federal Communications Commission for emergency use can establish communications with rescue authorities. A small portable radio may be used as a radio direction finder or for receiving time signals.
12. An Emergency Position Indicating Radiobeacon (EPIRB) and a Search and Rescue Transponder (SART) are absolutely essential (See Chapter 30 on Maritime Safety Systems).
13. Portable handheld satellite telephones, such as those manufactured by Iridium, Inmarsat, Globalstar and others, are now affordable and an invaluable tool to have in your emergency navigation kit.

2802. Most Probable Position

In the event of failure of primary electronic navigation systems, the navigator may need to establish the **most probable position** (MPP) of the vessel. Usually there is little doubt as to the position. The most recent fix updated with a DR position will be adequate. But when conflicting information or information of questionable reliability is received, the navigator must determine the MPP.

When complete positional information is lacking, or when the available information is questionable, the most probable position might be determined from the intersection of a single line of position and a DR, from a line of soundings, from lines of position which are somewhat inconsistent, or from a dead reckoning position with a correction for set and drift. Continue a dead reckoning plot from one fix to another because the DR plot often provides the best estimate of the MPP.

A series of estimated positions may not be consistent because of the continual revision of the estimate as additional information is received. However, it is good practice to plot all MPP's, and sometimes to maintain a separate EP plot based upon the best estimate of track and speed made good. This could indicate whether the present

course is a safe one.

2803. Plotting Sheets

If plotting sheets are not available, a Mercator plotting sheet can be constructed through either of two alternative methods based upon a graphical solution of the secant of the latitude, which approximates the expansion of latitude.

First method (Figure 2803a):

Step one: Draw a series of equally spaced vertical lines at any spacing desired. These are the meridians; label them at any desired interval, such as 1', 2', 5', 10', 30', 1°, etc.

Step two: Draw and label a horizontal line through the center of the sheet to represent the parallel of the mid-latitude of the area.

Step three: Through any convenient point, such as the intersection of the central meridian and the parallel of the mid-latitude, draw a line making an angle with the horizontal equal to the mid-latitude. In Figure 2803a this angle is 35°.

Step four: Draw in and label additional parallels. The length of the oblique line between meridians is the perpendicular distance between parallels, as shown by the broken arc. The number of minutes of arc between parallels is the same as that between the meridians.

Step five: Graduate the oblique line into convenient units. If 1' is selected, this scale serves as both a latitude and mile scale. It can also be used as a longitude scale by measuring horizontally from a meridian instead of obliquely along the line.

The meridians may be shown at the desired interval and the mid-parallel may be printed and graduated in units of longitude. In using the sheet it is necessary only to label the meridians and draw the oblique line. From it you may determine the interval used to draw in and label additional parallels. If the central meridian is graduated, the oblique line need not be.

Second method (Figure 2803b):

Step one: At the center of the sheet draw a circle with a radius equal to 1° (or any other convenient unit) of latitude at the desired scale. If a sheet with a compass rose is available, as in Figure 2803b, the compass rose can be used as the circle and will prove useful for measuring directions. It need not limit the scale of

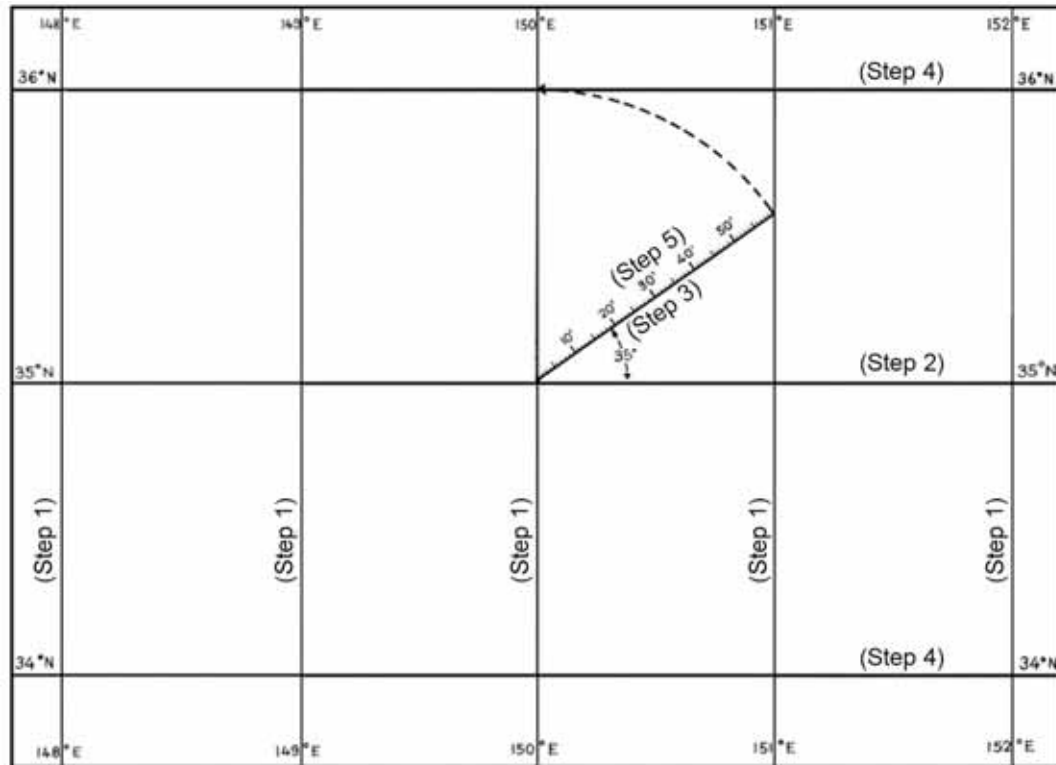

Figure 2803a. Small area plotting sheet with selected longitude scale.

the chart, as an additional concentric circle can be drawn, and desired graduations extended to it.

Step two: Draw horizontal lines through the center of the circle and tangent at the top and bottom. These are parallels of latitude; label them accordingly, at the selected interval (as every 1°, 30', etc.).

Step three: From the center of the circle draw a line making an angle with the horizontal equal to the mid-latitude. In Figure 2803b this angle is 40°.

Step four: Draw in and label the meridians. The first is a vertical line through the center of the circle. The second is a vertical line through the intersection of the oblique line and the circle. Additional meridians are drawn the same distance apart as the first two.

Step five: Graduate the oblique line into convenient units. If 1' is selected, this scale serves as a latitude and mile scale. It can also be used as a longitude scale by measuring horizontally from a meridian, instead of obliquely along the line.

In the second method, the parallels may be shown at the desired interval, and the central meridian may be printed

and graduated in units of latitude. In using the sheet it is necessary only to label the parallels, draw the oblique line, and from it determine the interval and draw in and label additional meridians. If the central meridian is graduated, as shown in Figure 2803b, the oblique line need not be.

The same result is produced by either method. The first method, starting with the selection of the longitude scale, is particularly useful when the longitude limits of the plotting sheet determine the scale. When the latitude coverage is more important, the second method may be preferable. In either method a simple compass rose might be printed.

Both methods use a constant relationship of latitude to longitude over the entire sheet and both fail to allow for the ellipticity of the Earth. For practical navigation these are not important considerations.

2804. Dead Reckoning

Of the various types of navigation, dead reckoning alone is always available in some form. In an emergency it is of more than average importance. With electronic systems out of service, keep a close check on speed, direction, and distance made good. Carefully evaluate the effects of wind and current. Long voyages with accurate landfalls have been successfully completed by this method alone. This is not meant to minimize the importance of other methods of determining position. However, a good dead reckoning position may actually be more accurate than one determined from several inexact LOP's. If the means of deter-

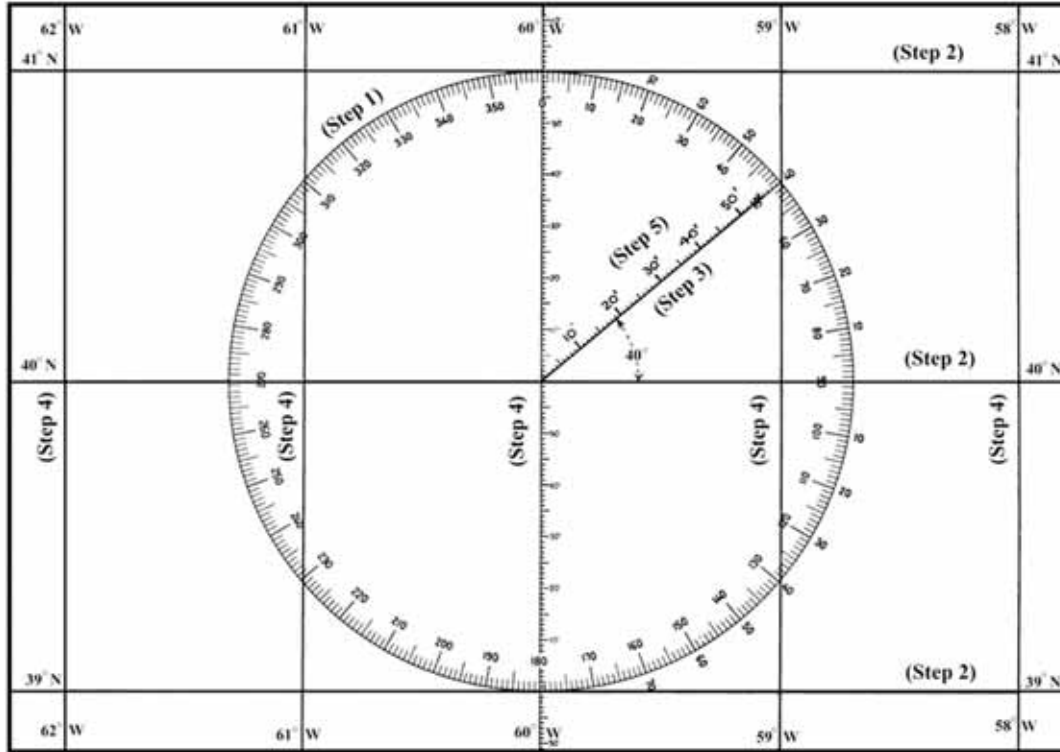

Figure 2803b. Small area plotting sheet with selected latitude scale.

Angle	0	18	31	41	49	56	63	69	75	81	87	90
Factor	1.0	0.9	0.8	0.7	0.6	0.5	0.4	0.3	0.2	0.1	0.0	

Table 2804. Simplified traverse table.

mining direction and distance (the elements of dead reckoning) are accurate, it may be best to adjust the dead reckoning only after a confident fix.

Plotting can be done directly on a *pilot chart* or plotting sheet. If this proves too difficult, or if an independent check is desired, some form of mathematical reckoning may be useful. Table 2804, a simplified traverse table, can be used for this purpose. To find the difference or change of latitude in minutes, enter the table with course angle, reckoned from north or south toward the east or west. Multiply the distance run in miles by the factor. To find the departure in miles, enter the table with the complement of the course angle. Multiply the distance run in miles by the factor. To convert departure to difference of longitude in minutes, enter the table with mid-latitude and divide the departure by the factor.

Example: A vessel travels 26 miles on course 205°, from Lat. 41°44'N, Long. 56°21'W.

Required: Latitude and longitude of the point of arrival.

Solution: The course angle is $205^\circ - 180^\circ = S25^\circ W$, and the complement is $90^\circ - 25^\circ = 65^\circ$. The factors corresponding to these angles are 0.9 and 0.4, respectively. The difference of latitude is $26 \times 0.9 = 23'$ (to the nearest minute) and the departure is $26 \times 0.4 = 10$ NM. Since the course is in the

southwestern quadrant in the Northern Hemisphere, the latitude of the point of arrival is $41^\circ 44' N - 23' = 41^\circ 21' N$. The factor corresponding to the mid-latitude $41^\circ 32' N$ is 0.7. The difference of longitude is $10 \div 0.7 = 14'$. The longitude of the point of arrival is $56^\circ 21' W + 14' = 56^\circ 35' W$.

Answer: Lat. 41°21'N, Long. 56°35'W.

2805. Deck Log

At the onset of a navigational emergency, a navigation log should be started if a deck log is not already being maintained. The date and time of the casualty should be the first entry, followed by navigational information such as ship's position, status of all navigation systems, the decisions made, and the reasons for them.

The best determination of the position of the casualty should be recorded, followed by a full account of courses, distances, positions, winds, currents, and leeway. No important navigational information should be left to memory.

2806. Direction

Direction is one of the elements of dead reckoning. A

deviation table for each compass, including any lifeboat compasses, should already have been determined. In the event of destruction or failure of the gyrocompass and bridge magnetic compass, lifeboat compasses can be used.

If an almanac, accurate Greenwich time, and the necessary tables are available, the azimuth of any celestial body can be computed and this value compared with an azimuth measured by the compass. If it is difficult to observe the compass azimuth, select a body dead ahead and note the compass heading. The difference between the computed and observed azimuths is compass error on that heading. This is of more immediate value than deviation, but if the latter is desired, it can be determined by applying variation to the compass error.

Several unique astronomical situations occur, permitting determination of azimuth without computation:

Polaris: Polaris is always within 2° of true north for observers between the equator and about 60° North. When Polaris is directly above or below the celestial pole, its azimuth is true north at any latitude. This occurs when the trailing star of either Cassiopeia or the Big Dipper is directly above or below Polaris. When these two stars form a horizontal line with Polaris, the maximum correction applies. Below about 50° latitude, this correction is 1°, and between 50° and 65°, it is 2°. If Cassiopeia is to the right of Polaris, the azimuth is 001° (002° above 50°N), and if Cassiopeia is to the left of Polaris, the azimuth is 359° (358° above 50°N).

The south celestial pole is located approximately at the intersection of a line through the longer axis of the Southern Cross with a line from the northernmost star of Triangulum Australe, perpendicular to the line joining the other two stars of the triangle. No conspicuous star marks this spot.

Meridian Transit: Any celestial body bears due north or south at meridian transit, either upper or lower. This is the moment of maximum (or minimum) altitude of the body. However, since the altitude at this time is nearly constant during a considerable change of azimuth, the instant of meridian transit may be difficult to determine. If time and an almanac are available, and the longitude is known, the time of transit can be computed. It can also be graphed as a curve on graph paper and the time of meridian transit determined with sufficient accuracy for emergency purposes.

Body on Prime Vertical: If any method is available for determining when a body is on the prime vertical (due east or west), the compass azimuth at this time can be observed. Table 21, Meridian Angle and Altitude of a Body on the Prime Vertical Circle, provides this information. Any body on the celestial equator (declination 0°) is on the prime vertical at the time of rising or setting. For the Sun this occurs at the time of the equinoxes. The star Mintaka (δ Orionis), the leading star of Orion's belt, has a declination of approximately 0.3°S and can be considered on the celestial equator. For an observer near the equator, such a body is always nearly east or west. Because of refraction

and dip, the azimuth should be noted when the center of the Sun or a star is a little more than one Sun diameter (half a degree) above the horizon. The Moon should be observed when its upper limb is on the horizon.

Body at Rising or Setting: Except for the Moon, the azimuth angle of a body is almost the same at rising as at setting, except that the former is toward the east and the latter toward the west. If the azimuth is measured both at rising and setting, true south (or north) is midway between the two observed values, and the difference between this value and 180° (or 000°) is the compass error. Thus, if the compass azimuth of a body is 073° at rising, and 277° at setting, true

south (180°) is $\frac{073^\circ + 277^\circ}{2} = 175^\circ$ by compass, and the

compass error is 5°E. This method may be in error if the vessel is moving rapidly in a northerly or southerly direction. If the declination and latitude are known, the true azimuth of any body at rising or setting can be determined by means of a diagram on the plane of the celestial meridian or by computation. For this purpose, the body (except the Moon) should be considered as rising or setting when its center is a little more than one Sun diameter (half a degree) above the horizon, because of refraction and dip.

Finding direction by the relationship of the Sun to the hands of a watch is sometimes advocated, but the limitations of this method prevent its practical use at sea.

A simple technique can be used for determining deviation. Find an object that is easily visible and that floats, but will not drift too fast in the wind. A life preserver, or several tied together, will suffice. Throw this marker overboard, and steer the vessel steadily in the exact opposite direction to the chosen course. At a distance of perhaps half a mile, or more if the marker is still clearly in view, execute a Williamson turn, or turn the vessel 180° in the smallest practical radius, and head back toward the marker. The magnetic course will be midway between the course toward the object and the reciprocal of the course away from the object. Thus, if the boat is on compass course 151° while heading away from the object, and 337° while returning, the magnetic course is midway between 337° and $151^\circ + 180^\circ = 331^\circ$, or

$$\frac{337^\circ + 331^\circ}{2} = 334^\circ .$$

Since 334° magnetic is the same as 337° by compass, the deviation on this heading is 3°W.

If a compass is not available, any celestial body can be used to steer by, if its diurnal apparent motion is considered. A reasonably straight course can be steered by noting the direction of the wind, the movement of the clouds, the direction of the waves, or by watching the wake of the vessel. The angle between the centerline and the wake is an indication of the amount of leeway.

A body having a declination the same as the latitude of the destination is directly over the destination once each day, when its hour angle equals the longitude, measured westward through

360°. At this time it should be dead ahead if the vessel is following the great circle leading directly to the destination.

Inspect the almanac to find a body with a suitable declination.

EMERGENCY CELESTIAL NAVIGATION

2807. Almanacs

Almanac information, particularly declination and Greenwich Hour Angle of bodies, is important to celestial navigation. If the only copy available is for a previous year, it can be used for the Sun, Aries (Υ), and stars without serious error by emergency standards. However, for greater accuracy, proceed as follows:

For declination of the Sun, enter the almanac with a time that is earlier than the correct time by 5^h 49^m multiplied by the number of years between the date of the almanac and the correct date, adding 24 hours for each February 29th that occurs between the dates. If the date is February 29th, use March 1 and reduce by one the number of 24 hour periods added. For GHA of the Sun or Aries, determine the value for the correct time, adjusting the minutes and tenths of arc to agree with that at the time for which the declination is determined. Since the adjustment never exceeds half a degree, care should be used when the value is near a whole degree, to prevent the value from being in error by 1°.

If no almanac is available, a rough approximation of the declination of the Sun can be obtained as follows: Count the days from the given date to the nearer solstice (June 21st or December 22nd). Divide this by the number of days from that solstice to the equinox (March 21st or September 23rd), using the equinox that will result in the given date being between it and the solstice. Multiply the result by 90°. Enter Table 2804 with the angle so found and extract the factor. Multiply this by 23.45° to find the declination.

Example 1: *The date is August 24th.*

Required: *The approximate declination of the Sun.*

Solution: *The number of days from the given date to the nearer solstice (June 21) is 64. There are 94 days between June 21 and September 23. Dividing and multiplying by 90°,*

$$\frac{64}{94} \times 90^\circ = 61.3'$$

The factor from Table 2804 is 0.5. The declination is $23.45^\circ \times 0.5 = 11.7^\circ$. We know it is north because of the date.

Answer: *Dec. 11.7°N.*

The accuracy of this solution can be improved by considering the factor of Table 2804 as the value for the mid-angle between the two limiting ones (except that 1.00 is correct for 0° and 0.00 is correct for 90°), and interpolating to one additional decimal. In this instance the

interpolation would be between 0.50 at 59.5° and 0.40 at 66°. The interpolated value is 0.47, giving a declination of 11.0°N. Still greater accuracy can be obtained by using a table of natural cosines instead of Table 2804. By natural cosine, the value is 11.3°N.

If the latitude is known, the declination of any body can be determined by observing a meridian altitude. It is usually best to make a number of observations shortly before and after transit, plot the values on graph paper, letting the ordinate (vertical scale) represent altitude, and the abscissa (horizontal scale) the time. The altitude is found by fairing a curve or drawing an arc of a circle through the points, and taking the highest value. A meridian altitude problem is then solved in reverse.

Example 2: *The latitude of a vessel is 40°16'S. The Sun is observed on the meridian, bearing north. The observed altitude is 36°29'.*

Required: *Declination of the Sun.*

Solution: *The zenith distance is $90^\circ - 36^\circ 29' = 53^\circ 31'$. The Sun is $53^\circ 31'$ north of the observer, or $13^\circ 15'$ north of the equator. Hence, the declination is $13^\circ 15' N$.*

Answer: *Dec. 13°15' N.*

The GHA of Aries can be determined approximately by considering it equal to GMT (in angular units) on September 23rd. To find GHA Aries on any other date, add 1° for each day following September 23rd. The value is approximately 90° on December 22nd, 180° on March 21st and 270° on June 21st. The values found can be in error by as much as several degrees, and so should not be used if better information is available. An approximate check is provided by the great circle through Polaris, Caph (the leading star of Cassiopeia), and the eastern side of the square of Pegasus. When this great circle coincides with the meridian, LHA Υ is approximately 0°. The hour angle of a body is equal to its SHA plus the hour angle of Aries. If an error of up to 4°, or a little more, is acceptable, the GHA of the Sun can be considered equal to $GMT \pm 180^\circ$ (12^h).

For more accurate results, one can make a table of the equation of time from the *Nautical Almanac* perhaps at five- or ten-day intervals, and include this in the emergency navigation kit. The equation of time is applied according to its sign to $GMT \pm 180^\circ$ to find GHA.

2808. Altitude Measurement

With a sextant, altitudes are measured in the usual manner. If in a small boat or raft, it is a good idea to make a number of observations and average both the altitudes and times, or plot on

graph paper the altitudes versus time. The rougher the sea, the more important this process becomes, which tends to average out errors caused by rough weather observations.

The improvisations which may be made in the absence of a sextant are so varied that in virtually any circumstances a little ingenuity will produce a device to measure altitude. The results obtained with any improvised method will be approximate at best, but if a number of observations are averaged, the accuracy can be improved. A measurement, however approximate, is better than an estimate. Two general types of improvisation are available:

1. Circle. Any circular degree scale, such as a maneuvering board, compass rose, protractor, or plotter can be used to measure altitude or zenith distance directly. This is the principle of the ancient astrolabe. A maneuvering board or compass rose can be mounted on a flat board. A protractor or plotter may be used directly. There are a number of variations of the technique of using such a device. Some of them are:

A peg or nail is placed at the center of the circle as seen in Figure 2808a. A weight is hung from the 90° graduation, and a string for holding the device is attached at the 270° graduation. When it is held with the weight acting as a plumb bob, the 0° - 180° line is horizontal. In this position the board is turned in azimuth until it is in line with the Sun. The intersection of the shadow of the center peg with the arc of the circle indicates the altitude of the center of the Sun.



Figure 2808a. Improvised astrolabe; shadow method.

The weight and loop can be omitted and pegs placed at the 0° and 180° points of the circle. While one observer sights along the line of pegs to the horizon, an assistant notes the altitude.

The weight can be attached to the center pin, and the three pins (0°, center, 180°) aligned with the celestial body.

The reading is made at the point where the string holding the weight crosses the scale. The reading thus obtained is the zenith distance unless the graduations are labeled to indicate altitude. This method, illustrated in Figure 2808b, is used for bodies other than the Sun.

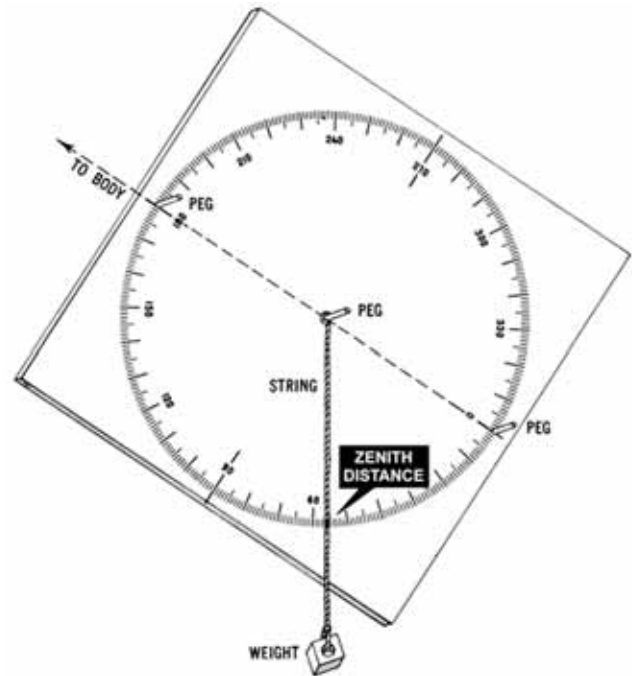

Figure 2808b. Improvised astrolabe; direct sighting method.

Whatever the technique, reverse the device for half the readings of a series to minimize errors of construction. Generally, the circle method produces more accurate results than the right triangle method, described below.

2. Right triangle. A cross-staff can be used to establish one or more right triangles, which can be solved by measuring the angle representing the altitude, either directly or by reconstructing the triangle. Another way of determining the altitude is to measure two sides of the triangle and divide one by the other to determine one of the trigonometric functions. This procedure, of course, requires a source of information on the values of trigonometric functions corresponding to various angles. If the cosine is found, Table 2804 can be used. The tabulated factors can be considered correct to one additional decimal for the value midway between the limited values (except that 1.00 is the correct value for 0° and 0.00 is the correct value for 90°) without serious error by emergency standards. Interpolation can then be made between such values.

By either protractor or table, most devices can be graduated in advance so that angles can be read directly. There are many variations of the right triangle method. Some of these are described below.

Two straight pieces of wood can be attached to each other in such a way that the shorter one can be moved along the longer,

the two always being perpendicular to each other. The shorter piece is attached at its center. One end of the longer arm is held to the eye. The shorter arm is moved until its top edge is in line with the celestial body, and its bottom edge is in line with the horizon. Thus, two right triangles are formed, each representing half the altitude. See Figure 2808c. For low altitudes, only one of the triangles is used, the long arm being held in line with the horizon. The length of half the short arm, divided by the length of that part of the long arm between the eye and the intersection with the short arm, is the tangent of half the altitude (the whole altitude if only one right triangle is used). The cosine can be found by dividing that part of the long arm between the eye and the intersection with the short arm by the slant distance from the eye to one end of the short arm. Graduations consist of a series of marks along the long arm indicating settings for various angles. The device should be inverted for alternate readings of a series.

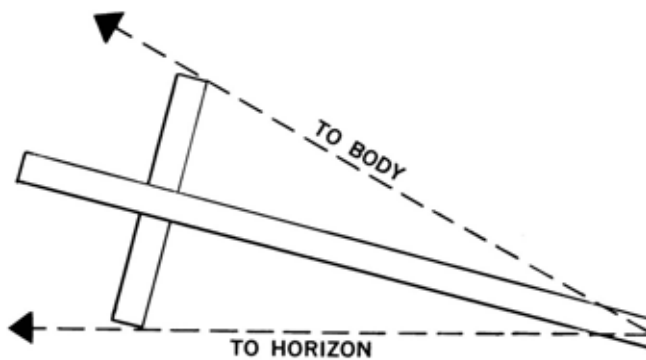

Figure 2808c. Improvised cross-staff.

A rule or any stick can be held at arm's length. The top of the rule is placed in line with the celestial body being observed, and the top of the thumb is placed in line with the horizon. The rule is held vertically. The length of rule above the thumb divided by the distance from the eye to the top of the thumb is the tangent of the angle observed. The cosine can be found by dividing the distance from the eye to the top of the thumb by the distance from the eye to the top of the rule. If the rule is tilted toward the eye until the minimum of rule is used, the distance from the eye to the middle of the rule is substituted for the distance from the eye to the top of the thumb, half the length of the rule above the thumb is used, and the angle found is multiplied by 2. Graduations consist of marks on the rule or stick indicating various altitudes. For the average observer each inch of rule will subtend an angle of about 2.3° , assuming an eye-to-ruler distance of 25 inches. This relationship is good to a maximum altitude of about 20° .

The accuracy of this relationship can be checked by comparing the measurement against known angles in the sky. Angular distances between stars can be computed by sight reduction methods, including *Pub. No. 229*, by using the declination of one star as the latitude of the assumed position, and the difference between the hour angles (or SHAs) of the

two bodies as the local hour angle. The angular distance is the complement of the computed altitude. The angular distances between some well-known star pairs are: end stars of Orion's belt, 2.7° ; pointers of the Big Dipper, 5.4° ; Rigel to Orion's belt, 9.0° ; eastern side of the great square of Pegasus, 14.0° ; Dubhe (the pointer nearer Polaris) and Mizar (the second star in the Big Dipper, counting from the end of the handle), 19.3° .

The angle between the lines of sight from each eye is, at arm's length, about 6° . By holding a pencil or finger horizontally and placing the head on its side, one can estimate an angle of about 6° by closing first one eye and then the other, and noting how much the pencil or finger appears to move in the sky.

The length of the shadow of a peg or nail mounted perpendicular to a horizontal board can be used as one side of an altitude triangle. The other sides are the height of the peg and the slant distance from the top of the peg to the end of the shadow. The height of the peg divided by the length of the shadow is the tangent of the altitude of the center of the Sun. The length of the shadow divided by the slant distance is the cosine. Graduations consist of a series of concentric circles indicating various altitudes, the peg being at the common center. The device is kept horizontal by floating it in a bucket of water. Half the readings of a series are taken with the board turned 180° in azimuth.

Two pegs or nails can be mounted perpendicular to a board, with a weight hung from the one farther from the eye. The board is held vertically and the two pegs aligned with the body being observed. A finger is then placed over the string holding the weight, to keep it in position as the board is turned on its side. A perpendicular line is dropped from the peg nearer the eye to the string. The body's altitude is the acute angle nearer the eye. For alternate readings of a series, the board should be inverted. Graduations consist of a series of marks indicating the position of the string at various altitudes.

As the altitude decreases the triangle becomes smaller. At the celestial horizon it becomes a straight line. No instrument is needed to measure the altitude when either the upper or lower limb is tangent to the horizon, as the sextant altitude is then 0° .

2809. Sextant Altitude Corrections

If altitudes are measured by a marine sextant, the usual sextant altitude corrections apply. If the center of the Sun or Moon is observed, either by sighting at the center or by shadow, the lower-limb corrections should be applied as usual, and an additional correction of minus $16'$ applied. If the upper limb is observed, use minus $32'$. If a weight is used as a plumb bob, or if the length of a shadow is measured, omit the dip (height of eye) correction.

If an almanac is not available for corrections, each source of error can be corrected separately, as follows:

If a sextant is used, the **index correction** should be determined and applied to all observations, or the sextant adjusted to eliminate index error.

Refraction is given to the nearest minute of arc in Table

Altitude	5°	6°	7°	8°	10°	12°	15°	21°	33°	63°	90°
Refraction	9'	8'	7'	6'	5'	4'	3'	2'	1'	0	

Table 2809. Simplified refraction table.

2809. The value for a horizon observation is 34'. If the nearest 0.1° is sufficiently accurate, as with an improvised method of observing altitude, a correction of 0.1° should be applied for altitudes between 5° and 18°, and no correction applied for greater altitudes. Refraction applies to all observations, and is always minus.

Dip, in minutes of arc, is approximately equal to the square root of the height of eye, in feet. The dip correction applies to all observations in which the horizon is used as the horizontal reference. It is always a minus. If 0.1° accuracy is acceptable, no dip correction is needed for height of eye in a small boat.

The **semidiameter** of the Sun and Moon is approximately 16' of arc. The correction does not apply to other bodies or to observations of the center of the Sun and Moon, by whatever method, including shadow. The correction is positive if the lower limb is observed, and negative if the upper limb is observed.

For emergency accuracy, **parallax** is applied to observations of the Moon only. An approximate value, in minutes of arc, can be found by multiplying 57' by the factor from Table 2804, entering that table with altitude. For more accurate results, the factors can be considered correct to one additional decimal for the altitude midway between the limiting values (except that 1.00 is correct for 0° and 0.00 is correct for 90°), and the values for other altitudes can be found by interpolation. This correction is always positive.

For observations of celestial bodies on the horizon, the total correction for zero height of eye is:

Sun: Lower limb: (-)18', upper limb: (-)50'.
 Moon: Lower limb: (+)39', upper limb: (+)7'.

Planet/Star: (-)34'.

Dip should be added algebraically to these values. Since the sextant altitude is zero, the observed altitude is equal to the total correction.

2810. Sight Reduction

Sight reduction tables should be used, if available. If not, use the compact *sight reduction tables* found in the *Nautical Almanac*. If trigonometric tables and the necessary formulas are available, they will serve the purpose. Speed in solution is seldom a factor in a liferaft, but might be important aboard ship, particularly in hostile areas. If tables but no formulas are available, determine the mathematical knowledge possessed by the crew. Someone may be able to provide the missing information. If the formulas are available, but no tables, approximate natural values of the various trigonometric functions can be obtained graphically. Graphical solution of the navigational triangle can be made by the orthographic method explained in Chapter 13, Navigational Astronomy. A

maneuvering board might prove helpful in the graphical solution for either trigonometric functions or altitude and azimuth. Very careful work will be needed for useful results by either method. Unless proper navigational equipment is available, better results might be obtained by making separate determinations of latitude and longitude.

2811. Finding Latitude

Several methods are available for determining latitude; none requires accurate time.

Latitude can be determined using a **meridian altitude** of any body, if its declination is known. If accurate time, knowledge of the longitude, and an almanac are available, the observation can be made at the correct moment, as determined in advance. However, if any of these are lacking, or if an accurate altitude measuring instrument is unavailable, it is better to make a number of altitude observations before and after meridian transit. Then plot altitude versus time on graph paper, and the highest (or lowest, for lower transit) altitude is scaled from a curve faired through the plotted points. At small boat speeds, this procedure is not likely to introduce a significant error. The time used for plotting the observations need not be accurate, as elapsed time between observations is all that is needed, and this is not of critical accuracy. Any altitudes that are not consistent with others of the series should be discarded.

Latitude by Polaris is explained in Chapter 19, Sight Reduction. In an emergency, only the first correction is of practical significance. If suitable tables are not available, this correction can be estimated. The trailing star of Cassiopeia (ϵ Cassiopeiae) and Polaris have almost exactly the same SHA. The trailing star of the Big Dipper (Alkaid) is nearly opposite Polaris and ϵ Cassiopeiae. These three stars, ϵ Cassiopeiae, Polaris, and Alkaid, form a line through the N. Celestial Pole (approximately). When this line is horizontal, there is no correction. When it is vertical, the maximum correction of 56' applies. It should be added to the observed altitude if Alkaid is at the top, and subtracted if ϵ Cassiopeiae is at the top. For any other position, estimate the angle this line makes with the vertical, and multiply the maximum correction (56') by the factor from Table 2804, adding if Alkaid is higher than ϵ Cassiopeiae, and subtracting if it is lower. See Figure 2811. For more accurate results, the factor from Table 2804 can be considered accurate to one additional decimal for the mid-value between those tabulated (except that 1.00 is correct for 0° and 0.00 for 90°). Other values can be found by interpolation.

The **length of the day** varies with latitude. Hence, latitude can be determined if the elapsed time between sunrise and sunset can be accurately observed. Correct the

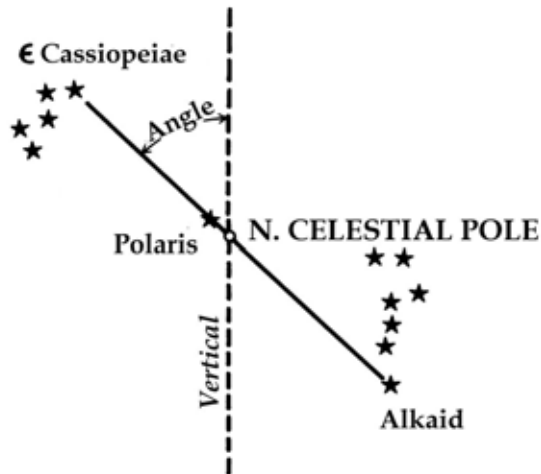

Figure 2811. Relative positions of ϵ Cassiopeiae, Polaris, and Alkaid with respect to the north celestial pole.

observed length of day by adding 1 minute for each 15' of longitude traveled toward the east and subtracting 1 minute for each 15' of longitude traveled toward the west. The latitude determined by length of day is the value for the time of meridian transit. Since meridian transit occurs approximately midway between sunrise and sunset, half the interval may be observed and doubled. If a sunrise and sunset table is not available, the length of daylight can be determined graphically using a diagram on the plane of the celestial meridian, as explained in Chapter 13. A maneuvering board is useful for this purpose. This method cannot be used near the time of the equinoxes and is of little value near the equator. The Moon can be used if moonrise and moonset tables are available. However, with the Moon, the half-interval method is of insufficient accuracy, and allowance should be made for the longitude correction.

The declination of a **body in zenith** is equal to the latitude of the observer. If no means are available to measure altitude, the position of the zenith can be determined by holding a weighted string overhead.

2812. Finding Longitude

Unlike latitude, determining longitude requires accurate Greenwich time. All such methods consist of noting the Greenwich time at which a phenomenon occurs

locally. In addition, a table indicating the time of occurrence of the same phenomenon at Greenwich, or equivalent information, is needed. Three methods may be used to determine longitude.

When a body is on the local celestial meridian, its GHA is the same as the longitude of the observer if in west longitude, or $360 - \lambda$ in east longitude. Thus, if the GMT of local **time of transit** is determined and a table of Greenwich Hour Angles (or time of transit of the Greenwich meridian) is available, longitude can be computed. If only the equation of time is available, the method can be used with the Sun. This is the reverse of the problem of finding the time of transit of a body. The time of transit is not always apparent. If a curve is made of altitude versus time, as suggested previously, the time corresponding to the highest altitude is used in finding longitude. Under some conditions, it may be preferable to observe an altitude before meridian transit, and then again after meridian transit when the body has returned to the same altitude as at the first observation. Meridian transit occurs midway between these two times. A body in the zenith is on the celestial meridian. If accurate azimuth measurement is available, note the time when the azimuth is 000° or 180° .

The difference between the observed GMT of sunrise or sunset and the LMT tabulated in the almanac is the longitude in time units, which can then be converted to angular measure. If the *Nautical Almanac* is used, this information is tabulated for each third day only. Greater accuracy can be obtained if interpolation is used for determining intermediate values. Moonrise or moonset can be used if the tabulated LMT is corrected for longitude. Planets and stars can be used if the time of rising or setting can be determined. This can be computed, or approximated using a diagram on the plane of the celestial meridian (See Chapter 13, Navigational Astronomy).

Either of these methods can be used in reverse to set a watch that has run down or to check the accuracy of a watch if the longitude is known. In the case of a meridian transit, the time at the instant of transit is not necessary.

Simply start the watch and measure the altitude several times before and after transit, or at equal altitudes before and after transit. Note the times of these observations and find the exact watch time of meridian transit. The difference between this time and the correct time of transit is the correction factor by which to reset the watch.

CHAPTER 29

NAVIGATION REGULATIONS

SHIP ROUTING

2900. Purpose and Types of Routing Systems

Navigation, once independent throughout the world, is an increasingly regulated activity. The consequences of collision or grounding for a large, modern ship carrying tremendous quantities of high-value, perhaps dangerous cargo are so severe that authorities have instituted many types of regulations and control systems to minimize the chances of loss. These range from informal and voluntary systems to closely controlled systems requiring strict compliance with numerous regulations. The regulations may concern navigation, communications, equipment, procedures, personnel, and many other aspects of ship management. This chapter will be concerned primarily with navigation regulations and procedures.

There are many types of vessel traffic rules. However, the cornerstone of all these are the *Navigation Rules: International-Inland*. The International Rules (Title 33 U.S.C. Chap. 30) were formalized in the Convention of the International Regulations for the Preventing of Collisions at Sea of 1972 (COLREGS '72) and became effective on July 15, 1977. Following the signing of the Convention, an effort was made to unify and update the various domestic navigation rules. This effort culminated in the enactment of the Inland Navigation Rules Act of 1980.

The Inland Navigation Rules (Title 33 U.S.C. Chap. 34) recodified parts of the Motorboat Act of 1940 and a large body of existing navigational practices, pilot rules, interpretive rules previously referred to as the Great Lakes Rules, Inland Rules and Western River Rules. The effective date for the Inland Navigation Rules was December 24, 1981, except for the Great Lakes where the effective date was March 1, 1983.

The International Rules apply to vessels on waters outside of the established lines of demarcation (COLREGS Demarcation Lines, 33 C.F.R. §80). These lines are depicted on U.S. charts with dashed lines, and generally run between major headlands and prominent points of land at the entrance to coastal rivers and harbors. The Inland Navigation Rules apply to waters inside the lines of demarcation. It is important to note that with the exception of Annex V to the Inland Rules, the International and Inland Navigation Rules are very similar in both content and format.

Much information relating to maritime regulations may be found on the World Wide Web, and any common search engine can turn up increasing amounts of documents

posted for mariners to access. As more and more regulatory information is posted to new Web sites and bandwidth increases, mariners will have easier access to the numerous rules with which they must comply.

2901. Terminology

There are several specific types of regulatory systems. For commonly used open ocean routes where risk of collision is present, the use of **Recommended Routes** separates ships going in opposite directions. In areas where ships converge at headlands, straits, and major harbors, **Traffic Separation Schemes** (TSS's) have been instituted to separate vessels and control crossing and meeting situations. **Vessel Traffic Services** (VTS's), sometimes used in conjunction with a TSS, are found in many of the major ports of the world. While TSS's are often found offshore in international waters, VTS's are invariably found closer to shore, in national waters. Environmentally sensitive areas may be protected by **Areas to be Avoided** which prevent vessels of a certain size or carrying certain cargoes from navigating within specified boundaries. In confined waterways such as canals, lock systems, and rivers leading to major ports, local navigation regulations often control ship movement.

The following terms relate to ship's routing:

Routing System: Any system of routes or routing measures designed to minimize the possibility of collisions between ships, including TSS's, two-way routes, recommended tracks, areas to be avoided, inshore traffic zones, precautionary areas, and deep-water routes.

Traffic Separation Scheme: A routing measure which separates opposing traffic flow with traffic lanes.

Separation Zone or Line: An area or line which separates opposing traffic, separates traffic from adjacent areas, or separates different classes of ships from one another.

Traffic Lane: An area within which one-way traffic is established.

Roundabout: A circular traffic lane used at junctions of several routes, within which traffic moves counterclockwise around a separation point or zone.

Inshore Traffic Zone: The area between a traffic separation scheme and the adjacent coast, usually designated for coastal traffic.

Two-Way Route: A two-way track for guidance of ships through hazardous areas.

Recommended Route: A route established for convenience of ship navigation, often marked with centerline buoys.

Recommended Track: A route, generally found to be free of dangers, which ships are advised to follow to avoid possible hazards nearby.

Deep-Water Route: A route surveyed and chosen for the passage of deep-draft vessels through shoal areas.

Precautionary Area: A routing measure comprising an area within defined limits where vessels must navigate with particular caution and within which the direction of traffic may be recommended.

Area to be Avoided: An area within which navigation by certain classes of ships is prohibited because of particular navigational dangers or environmentally sensitive natural features. They are depicted on charts by dashed or composite lines. The smallest may cover less than a mile in extent; the largest may cover hundreds of square miles. Notes on the appropriate charts and in pilots and *Sailing Directions* tell which classes of ships are excluded from the area.

No Anchoring Area: A routing measure comprising an area within defined limits where anchoring is hazardous or could result in unacceptable damage to the marine environment. Anchoring in a no anchoring area should be avoided by all ships or certain classes of ships, except in case of immediate danger to the ship or the persons onboard.

Established Direction of Traffic Flow: The direction in which traffic within a lane must travel.

Recommended Direction of Traffic Flow: The direction in which traffic is recommended to travel.

There are various methods by which ships may be separated using Traffic Separation Schemes. The simplest scheme might consist of just one method. More complex schemes will use several different methods together in a

coordinated pattern to route ships to and from several areas at once. Schemes may be just a few miles in extent, or cover relatively large sea areas.

2902. Recommended Routes and Tracks

Recommended Routes across the North Atlantic have been followed since 1898, when the risk of collision between increasing numbers of ships became too great, particularly at junction points. The International Convention for the Safety of Life at Sea (SOLAS) codifies the use of certain routes. These routes vary with the seasons, with winter and summer tracks chosen so as to avoid iceberg-prone areas. These routes are often shown on charts, particularly small scale ones, and are generally used to calculate distances between ports in tables.

Recommended Routes consist of single tracks, either one-way or two-way. Two-way routes show the best water through confined areas such as among islands and reefs. Ships following these routes can expect to meet other vessels head-on and engage in normal passings. One-way routes are generally found in areas where many ships are on similar or opposing courses. They are intended to separate opposing traffic so that most maneuvers are overtaking situations instead of the more dangerous meeting situation.

2903. Charting Routing Systems

Routing Systems and TSS's are depicted on nautical charts in magenta (purple) or black as the primary color. Zones are shown by purple tint, limits are shown by composite lines such as are used in other maritime limits, and lines are dashed. Arrows are outlined or dashed-lined depending on use. Deep-water routes are marked with the designation "DW" in bold purple letters, and the least depth may be indicated.

Recommended Routes and recommended tracks are generally indicated on charts by black lines, with arrowheads indicating the desired direction of traffic. Areas to be Avoided are depicted on charts by dashed lines or composite lines, either point to point straight lines or as a circle centered on a feature in question such as a rock or island.

Note that not all ship's routing measures are charted. U.S. charts generally depict recommended routes only on charts made directly from foreign charts. Special provisions applying to a scheme may be mentioned in notes on the chart and are usually discussed in detail in the *Sailing Directions*. In the U.S., the boundaries and routing scheme's general location and purpose are set forth in the Code of Federal Regulations and appear in the *Coast Pilot*.

TRAFFIC SEPARATION SCHEMES

2904. Traffic Separation Schemes (TSS)

In 1961, representatives from England, France, and

Germany met to discuss ways to separate traffic in the congested Straits of Dover and subsequently in other congested areas. Their proposals were submitted to the

International Maritime Organization (IMO) and were adopted in general form. IMO expanded on the proposals and has since instituted a system of **Traffic Separation Schemes (TSS)** throughout the world. See Figure 2904 for a depiction of how a TSS may appear on a paper chart.

The IMO is the only international body responsible for establishing and recommending measures for ship's routing in international waters. It does not attempt to regulate traffic within the territorial waters of any nation.

In deciding whether or not to adopt a TSS, IMO considers the aids to navigation system in the area, the state of hydrographic surveys, the scheme's adherence to accepted standards of routing, and the International Rules of the Road. The selection and development of TSS's are the responsibility of individual governments, who may seek IMO adoption of their plans, especially if the system extends into international waters.

Governments may develop and implement TSS's not adopted by the IMO, but in general only IMO-adopted schemes are charted. Rule 10 of the International Regulations for Preventing Collisions at Sea (Rules of the Road) addresses the subject of TSS's. This rule specifies the actions to be taken by various classes of vessels in and near traffic separation schemes.

Traffic separation schemes adopted by the IMO are listed in *Ship's Routing*, a publication of the IMO. Because of differences in datums, chartlets in this publication which depict the various schemes must not be used either for navigation or to chart the schemes on navigational charts. The *Notice to Mariners* should be consulted for charting details. The symbology for TSS tracks and routes are described in more detail in section "M" of *U.S. Chart No. 1*, (12th edition, 2013).



Figure 2904. Traffic separation scheme examples.

2905. Methods and Depiction

A number of different methods of separating traffic have been developed, using various zones, lines, and defined areas. One or more methods may be employed in a given traffic scheme to direct and control converging or passing traffic. These are discussed below. Refer to definitions in section 2901 and Figure 2905.

Method 1. Separation of opposing streams of traffic by separation zones or lines. In this method, typically a central

separation zone is established within which ships are not to navigate. The central zone is bordered by traffic lanes with established directions of traffic flow. The lanes are bounded on the outside by limiting lines.

Method 2. Separation of opposing streams of traffic by natural features or defined objects. In this method islands, rocks, or other features may be used to separate traffic. The feature itself becomes the separation zone.

Method 3. Separation of through traffic from local traffic by provision of Inshore Traffic Zones. Inshore traffic zones provide an area within which local traffic may travel at will without interference from through traffic in the lanes. Inshore zones are separated from traffic lanes by separation zones or lines.

Method 4. Division of traffic from several different directions into sectors. This approach is used at points of convergence such as pilot stations and major entrances.

Method 5. Routing traffic through junctions of two or more major shipping routes. The exact design of the scheme in this method varies with conditions. It may be a circular or rectangular precautionary area, a roundabout, or a junction of two routes with crossing routes and directions of flow well defined.

2906. Use of Traffic Separation Schemes

A TSS is not officially approved for use until adopted by the IMO. Once adopted, it is implemented at a certain time and date and announced in the *Notice to Mariners* and by other means. The *Notice to Mariners* will also describe the scheme's general location and purpose, and give specific directions in the chart correction section on plotting the various zones and lines which define it. These corrections usually apply to several charts. Because the charts may range in scale from quite small to very large, the corrections for each should be followed closely. The positions for the various features may be slightly different from chart to chart due to differences in rounding off positions or chart datum.

Use of TSS's by all ships is recommended but not always required. In the event of a collision, vessel compliance with the TSS is a factor in assigning liability in admiralty courts. TSS's are intended for use in all weather, both day and night. Adequate aids to navigation are a part of all TSS's. There is no special right of one ship over another in TSS's because the *Rules of the Road* apply in all cases. Deep-water routes should be avoided by ships that do not need them to keep them clear for deep-draft vessels. Ships need not keep strictly to the courses indicated by the arrows, but are free to navigate as necessary within their lanes to avoid other traffic. The signal "YG" is provided in the International Code of Signals to indicate to another ship: "You appear not to be complying with the traffic separation scheme." TSS's are discussed in detail in the *Sailing Directions* for the areas where they are found.

No.	INT	Description	NOAA	NGA	Other NGA	ECDIS
Routing Measures						
Basic Symbols						
10		Established (mandatory) direction of traffic flow				
11		Recommended direction of traffic flow				
12		Separation line (large scale, small scale)				
13		Separation zone				
14		Limit of restricted routing measure (e.g. Inshore Traffic Zone (ITZ), Area to be Avoided (ATBA))				
15		Limit of routing measure				
16		Precautionary area				
17		Archipelagic Sea Lane (ASL); axis line and limit beyond which vessels shall not navigate				
18		Fairway designated by regulatory authority with minimum depth				
		Fairway designated by regulatory authority with maximum authorized draft				

Figure 2905. Extract from U.S. Chart No. 1. Routing measures symbology.

Certain special rules adopted by IMO apply in constricted areas such as the Straits of Malacca and Singapore, the English Channel and Dover Strait, and in the Gulf of Suez. These regulations are summarized in the

appropriate *Sailing Directions (Planning Guides)*. For a complete summary of worldwide ships' routing measures, the IMO publication *Ship's Routing* should be obtained. See Section 2904.

VESSEL TRAFFIC SERVICES (VTS)

2907. Description and Purpose

Vessel Traffic Services in the U.S. are implemented under the authority of the Ports and Waterways Safety Act of 1972 (Public Law 92-340 as amended) and the St. Lawrence Seaway Act (Public Law 358).

The purpose of a **Vessel Traffic Service (VTS)** is to provide active monitoring and navigational advice for vessels in particularly confined and busy waterways. There are two main types of VTS, surveilled and non-surveilled. Surveilled systems consist of one or more land-based sensors (i.e. radar, AIS and closed circuit television sites), which output their signals to a central location where operators monitor and manage vessel traffic movement. Non-surveilled systems consist of one or more reporting points at which ships are required to report their identity, course, speed, and other data to the monitoring authority. They encompass a wide range of techniques and capabilities aimed at preventing vessel collisions and groundings in the harbor, harbor approach and inland waterway phase of navigation. They are also designed to expedite ship movements, increase transportation system efficiency, and improve all-weather operating capability.

A VTS is a service implemented by a Competent Authority, designed to improve safety and efficiency of vessel traffic and to protect the environment. VTS's are equipped, staffed and enabled to interact with marine traffic through the provision of specific services and to respond to developing situations in the interest of safety and efficiency. In those ports where a VTS has been determined to be the appropriate traffic management tool, three levels of service have been defined to assist Competent Authorities in determining the type of service provided. The services and functions provided include:

Information Service (INS), this service normally provides the position, intentions and destination of vessels operating within the VTS area, usually by broadcasting information at fixed times and intervals or when deemed necessary by the VTS.

Traffic Organization Service (TOS), this service provides advance planning of movements and is particularly useful during times of congestion or waterways restriction. The VTS monitors traffic and enforces adherence to rules and regulations. The service may also include prioritization of movements, allocation of space, mandatory position reporting, established routes, speed limits, and/or other measures that may be considered necessary and appropriate by the VTS.

Navigation Assistance Service (NAS), this service

may be provided in addition to an Information Service and/or Traffic Organization Service. The NAS is designed to assist in the on-board navigational decision-making process and is provided at the request of a vessel, or when deemed necessary by the VTS. The NAS provides essential and timely navigational information and may inform, advise and/or instruct vessels accordingly. Most major maritime nations now operate vessel traffic services in large, congested ports and harbors.

VHF-FM communications network forms the basis of most major services. Transiting vessels make position reports to a vessel traffic center by radiotelephone and are in turn provided with accurate, complete, and timely navigational safety information. The addition of a network of radars, AIS, and close circuit television cameras for surveillance and computer-assisted tracking, similar to that used in air traffic control, allows the VTS to play a more significant role in marine traffic management, thereby decreasing vessel congestion, critical encounter situations, and the probability of a marine casualty resulting in environmental damage.

Automatic Identification Systems (AIS) may be integrated into VTS operations. This rapidly developing technology is similar to the transponder in an aircraft, which sends out a radio signal containing information such as the name of the vessel, course, speed, etc. This data appears as a text tag, attached to the radar blip, on systems designed to receive and process the signals. It enhances the ability of VTS operators to monitor and control shipping in busy ports.

AIS technology relies upon global navigational positioning systems (GPS), navigation sensors, and digital communication equipment operating according to standardized protocols (AIS transponders) that permit the voiceless exchange of navigation information between vessels and shore-side vessel traffic centers. AIS transponders can broadcast vessel information such as name or call sign, dimensions, type, GPS position, course, speed, and navigation status. This information is continually updated and received by all AIS-equipped vessels in its vicinity. An AIS-based VTS reduces the need for voice interactions, enhances mariners' ability to navigate, improves their situational awareness, and assists them in the performance of their duties thus reducing the risk of collisions.

The Coast Guard recognized the importance of AIS and has led the way on various international fronts for acceptance and adoption of this technology. The Coast Guard permits certain variations of AIS in VTS Prince William Sound and has conducted or participated in extensive oper-

ational tests of several Universal AIS (ITU-R M.1371) precursors. The most comprehensive test bed has been on the Lower Mississippi River. AIS is discussed in greater detail in Chapter 30.

The **Nationwide Automatic Identification System (NAIS)** consists of approximately 200 VHF receiver sites located throughout the coastal continental United States, inland rivers, Alaska, Hawaii and Guam. NAIS is designed to collect AIS transmissions from local vessels. Currently, NAIS collects valuable maritime data in 58 critical ports throughout the United States for use by Coast Guard operators and port partners. The primary goal of NAIS is to increase Maritime Domain Awareness (MDA) through data dissemination via a network infrastructure, particularly focusing on improving maritime security, marine and navigational safety, search and rescue, and environmental protection services.

In response to the Maritime Transportation Security Act of 2002, the NAIS Project was initiated and officially chartered in December 2004. NAIS allows the USCG to collect safety and security data from AIS-equipped vessels in the nation's territorial waters and adjacent sea areas, and share that data with USCG operators and other government partners. AIS data collected improves the safety of vessels and ports through collision avoidance and the safety of the nation through detection, identification, and classification of vessels.

NAIS consists of an integrated system of AIS, data storage, processing, and networking infrastructure. In addition, NAIS integrates with other systems for purposes of sharing infrastructure, quicker implementation, and improved performance.

Ports and Waterways Safety System (PAWSS) is a major acquisition project to build new Vessel Traffic Services where necessary and replace existing systems. It is also a process that reaches out to port stakeholders to comprehensively assess safety and identify needed corrective actions.

The PAWSS Vessel Traffic Service (VTS) project is a national transportation system that collects, processes, and disseminates information on the marine operating environment and maritime vessel traffic in major U.S. ports and waterways. The PAWSS VTS mission is monitoring and assessing vessel movements within a Vessel Traffic Service Area, exchanging information regarding vessel movements with vessel and shore-based personnel, and providing advisories to vessel masters. Other Coast Guard missions are supported through the exchange of information with appropriate Coast Guard units.

The Coast Guard has a statutory responsibility under the Ports and Waterways Safety Act of 1972 (PWSA), Title 33 USC §1221 to ensure the safety and environmental protection of U.S. ports and waterways. The PWSA authorizes the Coast Guard to "...establish, operate and maintain vessel traffic services in ports and waterways subject to congestion." It also authorizes the Coast Guard to require the

carriage of electronic devices necessary for participation in the VTS system. The purpose of the act was to establish good order and predictability on United States waterways by implementing fundamental waterways management practices. In 1996 the U.S. Congress required the Coast Guard to begin an analysis of future VTS system requirements. Congress specifically directed the Coast Guard to revisit the VTS program and focus on user involvement, meeting minimum safety needs, using affordable systems, using off-the-shelf technology, and exploring public-private partnership opportunities. The Coast Guard's PAWSS project was established to meet these goals.

The VTS system at each port has a Vessel Traffic Center that receives vessel movement data from the Automatic Identification System (AIS), surveillance sensors, other sources, or directly from vessels. Meteorological and hydrographic data is also received at the vessel traffic center and disseminate as needed. A major goal of the PAWSS VTS is to use AIS and other technologies that enable information gathering and dissemination in ways that add no additional operational burden to the mariner. The VTS adds value, improves safety and efficiency, but is not laborious to vessel operators.

Surveilled VTS's are found in many large ports and harbors where congestion is a safety and operational hazard. Less sophisticated services have been established in other areas in response to hazardous navigational conditions according to the needs and resources of the authorities.

Designated radio frequencies are port specific and denoted on the U.S. Coast Guard's Navigation Center webpage (www.navcen.uscg.gov). In the event of a communication failure either by the vessel traffic center or the vessel or radio congestion on a designated VTS frequency, communications may be established on an alternate VTS frequency. The bridge-to-bridge navigational frequency 156.650 MHz (Channel 13), is monitored in each VTS area; and it may be used as an alternate frequency, however, only to the extent that doing so provides a level of safety beyond that provided by other means.

2908. History of Vessel Traffic Services

The concept of managing ship movements through a shore-side radar station is generally accepted to have first appeared in the port of Liverpool in 1949. In 1956, the Netherlands established a system of radar stations for the surveillance of traffic at the port of Rotterdam. As VTS evolved and spread in Western Europe, the commercial well being of the port was the stimulus for new or expanded service. This contrasts sharply with the U.S. experience, where the first Federal (Coast Guard) VTS was an outgrowth of a 1968 research and development effort in San Francisco Bay called Harbor Advisory Radar. It was, as the name suggests, an advisory activity and participation in the system was voluntary. Because it was voluntary, not all

vessels availed themselves of VTS assistance or contributed to the service.

On January 18, 1971, the tankers Arizona Standard and Oregon Standard collided under the Golden Gate Bridge. The incident received nationwide attention and resulted in two significant maritime related safety initiatives - The Bridge to Bridge Radiotelephone Act, Title 33 USC §1201 and The Ports and Waterways Safety Act of 1972 (PWSA), Title 33 USC §1221. It is from the latter that the Coast Guard draws its authority to construct, maintain and operate VTSs. It also authorizes the Coast Guard to require the carriage of electronic devices necessary for participation in the VTS system. The purpose of the act was to establish good order and predictability on United States waterways by implementing fundamental waterways management practices.

Using PWSA as the authority and the San Francisco Harbor Advisory Radar as the operational model, the Coast Guard began to establish VTSs in critical, congested ports. San Francisco was formally established along with Puget Sound (Seattle) in 1972; Louisville, KY which is only activated during high water in the Ohio River (approximately 50 days per year) was started in 1973; Houston-Galveston, Prince William Sound; Berwick Bay (Louisiana) and the St. Mary's River at Sault Ste Marie, MI. New Orleans and New York provided services on a voluntary basis throughout the 1970-80's, however; these operations were curtailed in 1988 due to budgetary restraints. And, brought back on-line subsequent to the EXXON VALDEZ disaster, when the Coast Guard was mandated by the Oil Pollution Act of 1990 to make participation mandatory at existing and future VTSs.

2909. U.S. Operational Systems

The Coast Guard operates 12 Vessel Traffic Centers (VTC): Prince William Sound (Valdez), Puget Sound/Seattle, San Francisco, Los Angeles/Long Beach, Houston/Galveston, Berwick Bay, Louisville, Saint Mary's River, Lower Mississippi River, Port Arthur, Tampa, and New York. Each center is discussed in greater detail in the paragraphs below.

VTS New York has the responsibility of coordinating vessel traffic movements in the busy ports of New York and New Jersey. The VTS New York area includes the entrance to the harbor via Ambrose and Sandy Hook Channels, through the Verrazano Narrows Bridge to the Throgs Neck Bridge in the East River, to the Holland Tunnel in the Hudson River, the Kill Van Kull including Newark Bay and all of Arthur Kill, and Raritan Bay.

The current operation uses surveillance data provided by several radar sites, AIS and three closed circuit TV sites.

VTS San Francisco was commissioned in August of 1972. When the original radar system became operational in May 1973, the control center for VTS San Francisco was shifted to the Yerba Buena Island. This center was designated a Vessel Traffic Center (VTC).

VTS San Francisco is responsible for the safety of vessel movements along approximately 133 miles of waterway from offshore to the ports of Stockton and Sacramento. On 3 May 1995, federal regulations went into effect establishing regulated navigation areas within the San Francisco Bay Region. These regulations, developed with input from the Harbor Safety Committee of the San Francisco Bay Region, were designed to improve navigation safety by organizing traffic flow patterns; reducing meeting, crossing, and overtaking situations in constricted channels; and by limiting vessels' speeds. Major components of the system include a Vessel Traffic Center (at Yerba Buena Island), two high resolution radars, AIS, a VHF-FM communications network, a traffic separation scheme, and a **Vessel Movement Reporting System (VMRS)** which is the system used to monitor and track vessels movements within a VTS or VMRS area.

VTS San Francisco also operates an **Offshore Vessel Movement Reporting System (OVMS)**. The OVMS is completely voluntary and operates using a broadcast system with information provided by participants.

VTS Puget Sound became operational in September 1972 as the second Vessel Traffic Service. It collected vessel movement report data and provided traffic advisories by means of a VHF-FM communications network. In this early service a VMRS was operated in conjunction with a Traffic Separation Scheme (TSS), without radar surveillance. Operational experience gained from this service and VTS San Francisco soon proved the expected need for radar surveillance in those services with complex traffic flow.

In 1973 radar coverage in critical areas of Puget Sound was provided. Efforts to develop a production generation of radar equipment for future port development were initiated. To satisfy the need for immediate radar coverage, redundant military grade Coast Guard shipboard radar transceivers were installed at four Coast Guard light stations along the Admiralty Inlet part of Puget Sound. Combination microwave radio link and radar antenna towers were installed at each site. Radar video and azimuth data, in a format similar to that used with VTS San Francisco, were relayed by broad band video links to the VTC in Seattle. At that center, standard Navy shipboard repeaters were used for operator display. Although the resolution parameters and display accuracy of the equipment were less than those of the VTS San Francisco equipment, the use of a shorter range scale (8 nautical miles) and overlapping coverage resulted in very satisfactory operation. In December 1980 additional radar surveillance was added in the Strait of Juan De Fuca and Rosario Strait, as well as increased surveillance of the Seattle area, making a total of 10 remote radar sites.

The communications equipment was upgraded in July 1991 to be capable of a two frequency, four sector system. Channels 5A and 14 are the frequencies for VTS Puget Sound. A total of 13 communication sites are in operation (3 extended area sites, 10 low level sites). The three extended

area sites allow the VTS the ability to communicate in a large area when needed. The low level sites can be used in conjunction with one another without interference, and have greatly reduced congestion on the frequency. VTS Puget Sound now covers the Strait of Juan de Fuca, Rosario Strait, Admiralty Inlet, and Puget Sound south as far as Olympia.

The major components of the system include the Vessel Traffic Center at Pier 36 in Seattle, a VHF-FM communications network, a traffic separation scheme, radar surveillance of about 80% of the VTS area, AIS and a Vessel Movement Reporting System. Regulations are in effect which require certain classes of vessels to participate in the system and make movement reports at specified points. The traffic separation scheme in the Strait of Juan de Fuca was extended as far west as Cape Flattery in March 1975 in cooperation with Canada and was formally adopted by the International Maritime Organization in 1982.

Since 1979, the U.S. Coast Guard has worked cooperatively with the Canadian Coast Guard in managing vessel traffic in adjacent waters. Through the **Cooperative Vessel Traffic Service (CVTS)**, two Canadian Vessel Traffic Centers work hand in hand with Puget Sound Vessel Traffic Service. Prince Rupert MCTS (Marine Communications and Traffic Services) manages the area west of the Strait of Juan de Fuca. North of the Strait of Juan de Fuca, through Haro Strait, to Vancouver, B.C. is managed by VICTORIA MCTS. The three Vessel Traffic Centers communicate via a computer link and dedicated telephone lines to advise each other of vessels passing between their respective zones.

VTS Houston-Galveston became operational in February 1975 as the third U.S. Vessel Traffic Service. The Vessel Traffic Center is located at Sector Houston-Galveston in Southeast Houston. The VTS operating area includes the Houston Ship Channel from the sea buoy to the Buffalo Bayou Turning Basin, Galveston Channel, Texas City Channel, Bayport Ship Channel, Barbours Terminal Channel, and 10 miles of the ICW. The area contains more than 70 miles of restricted waterways. The main part of the Houston Ship Channel is 530 feet wide with a depth of 45 feet. Several bends in the channel are in excess of 90 degrees.

The major components of the system include the VTC at Galena Park, Houston; a VHF-FM communications network; low light level, closed circuit television (LLL-CCTV) surveillance covering approximately three miles south of Morgan's Point west through the ship channel to City Dock #27 in Houston; a Vessel Movement Reporting System; and a radar surveillance system covering lower Galveston Bay approaches, Bolivar Roads, and Lower Galveston Bay.

A second radar was installed in 1994. This radar provides surveillance coverage between the Texas City channel and Morgan's Point. The entire VTS area is covered by AIS.

VTS Prince William Sound is required by The Trans-

Alaska Pipeline Authorization Act (Public Law 93-153), pursuant to authority contained in Title 1 of the Ports and Waterways Safety Act of 1972 (86 Stat. 424, Public Law 92-340).

The Vessel Traffic Center is located in Valdez. The Coast Guard has installed a dependent surveillance system to improve its ability to track tankers transiting Prince William Sound and requires these vessels to carry position and identification reporting equipment. The ability to supplement radar with dependent surveillance bridges the gap in areas where conditions dictate some form of surveillance and where radar coverage is impractical. Once the dependent surveillance information is returned to the vessel traffic center, it is integrated with radar data and presented to the watchstander on an electronic chart display.

The system is composed of two radars, two major microwave data relay systems, and a VMRS which covers Port Valdez, Prince William Sound, and Gulf of Alaska. There is also a vessel traffic separation scheme from Cape Hinchinbrook to Valdez Arm.

The Coast Guard installed a dependent surveillance system to improve its ability to track tankers transiting Prince William Sound, however, that system was ultimately retired and replaced by AIS.

The southern terminus of the pipeline is on the south shoreline of the Port of Valdez, at the Alyeska Pipeline Service Company tanker terminal. Port Valdez is at the north end of Prince William Sound, and Cape Hinchinbrook is at the south entrance. Geographically, the area is comprised of deep open waterways surrounded by mountainous terrain. The only constrictions to navigation are at Cape Hinchinbrook, the primary entrance to Prince William Sound, and at Valdez Narrows, the entrance to Port Valdez.

VTS Saint Mary's River has been operational since October 1994 when it became a mandatory system operating year-round with an area of responsibility encompassing the entire length of the St. Mary's River (Approx. 80 miles).

On March 6, 1896, Title 33 USC 474 directed the Commandant of the Revenue Cutter Service to prescribe appropriate rules and regulations regarding the movement and anchorage of vessels and rafts in the St Marys River from Point Iroquois on Lake Superior to Point Detour on Lake Huron. This marked the beginning of the St Marys River Vessel Traffic Service (VTS). Originally named the River Patrol Service, this fledgling VTS operation was initially comprised of the Revenue Cutter MORRELL and Lookout Stations at Johnson's Pt (#1), Middle Neebish Dyke (#2) and Little Rapids Cut (#3). The stations were connected by telegraph lines linked back to the Pittsburgh Steamship Company offices in Sault Sainte Marie, MI. "Soo Control", the call sign for the original traffic management control center, evolved into a vessel movement reporting system which relied heavily on mariners to provide information on traffic flow and hazards. Formerly renamed the Vessel Traffic Service in 1975, VTS St. Marys River was initially a voluntary vessel movement reporting

system.

The St Marys River is a complex waterway. It features strong currents, wind driven water level fluctuations and narrow channels which challenge the most seasoned of navigators. Within the VTS area the water level drops approx. 21 feet from the level of Lake Superior to the level of the lower lakes. Thus, the Soo Locks were constructed and are presently maintained by the Corps of Engineers. In most of the areas of the river there is adequate room for vessels to maneuver or anchor during periods of low visibility, or when other problems hinder safe navigation. However, there are three areas extremely hazardous to transit or anchor in low visibility: West Neebish Channel (down-bound traffic only), Middle Neebish Channel (Up-bound traffic only), and Little Rapids Cut (two-way traffic). During periods of low visibility it is customary to close the entire river. Today VTS St. Marys River, a sub unit of Sector Sault Sainte Marie, maintains close alliances with their Canadian counterparts in Sarnia Ontario, the Army Corps of Engineers and the Great Lakes Maritime Industry. Coordination among these key players is paramount particularly during the ice breaking season. Each winter when plate ice can reach a thickness of three to five feet, the cooperation and exchange of information fostered by these corporate and governmental partnerships is the key to the safe and efficient movement of commercial interests.

VTS Lower Mississippi River is a component of the Waterway Division of USCG Sector New Orleans. VTS Lower Mississippi River manages vessel traffic on one of the most hazardous waterway in the United States due to the complexity of the marine traffic and the powerful currents of the Mississippi River. The Vessel Traffic Center is located in a high rise office building in the New Orleans Central Business District. Its area of responsibility spans from twenty miles above the Port of Baton Rouge (Mile 255 above the Head of the Passes) to twelve miles offshore of Southwest Pass Light in the Gulf of Mexico. Within this VTS service area the VTS monitors the Eighty One Mile Point Regulated Navigation Area (Mile 187.9 to Mile 167 Ahead of Passes) and the New Orleans Harbor Sector (Mile 106 to Mile 88). The VTS provides advisory and navigational assistance services at all times in these areas of responsibility. When the river reaches high water levels of eight feet in New Orleans, the VTS controls traffic at the Algiers Point Special Area (Mile 93.5 to Mile 95). VTS Lower Mississippi River is a unique Coast Guard Vessel Traffic Service because it maintains advisory service and direct control of vessel traffic with a workforce of highly trained and experienced civilian Coast Guard personnel with the assistance of pilot advisors.

VTS Berwick Bay manages vessel traffic on another hazardous waterway influenced by strong currents and a series of bridges that must be negotiated by inland tows traveling between Houston, Baton Rouge and New Orleans. The Vessel Traffic Center is located at Coast Guard Marine Safety Office Morgan City, LA. Its area of responsibility encompasses the junction of the Atchafalaya River (an outflow

of the Mississippi River), the Gulf Intracoastal Waterway, the Port Allen-Morgan City Alternate Route and several tributary bayous. Narrow bridge openings and a swift river current require the VTS to maintain one-way traffic flow through the bridges. During seasonal high water periods, the VTS enforces towing regulations that require inland tows transiting the bridges to have a minimum amount of horsepower based on the length of tow. VTS Berwick Bay is unique among Coast Guard Vessel Traffic Services because it maintains direct control of vessel traffic.

VTS Port Arthur actively monitors all waters of the Sabine-Neches Waterway to Port Arthur, Beaumont, and Orange, TX, including the offshore fairway to the sea buoy, the east/west crossing offshore fairway extending 12 miles on either side of the main channel, and the Gulf Intracoastal Waterway from mile 260 to mile 295. This area is home to the Ports of Port Arthur, Beaumont, and Orange, Texas. Additionally, it is the home of four large oil refineries, two Liquefied Natural Gas terminals, twenty-five percent of the nation's Strategic Petroleum Reserves, and the largest commercial military outload port in the U.S.

VTS Louisville is a vessel movement reporting system designed to enable vessel operators to better cope with problems encountered during high water on the Ohio River between miles 592.0 and 606.0. The VTS has four cameras surveying the waterway. It monitors traffic via VHF Channel 13 communications only. The VTS is activated when the upper river gauge at the McAlpine Lock and Dam is approximately 13.0 feet and rising. It remains in 24-hour operation until the upper river gauge falls below 13.0 feet. River conditions vary widely, especially during springtime. A series of thunderstorms can, at times, necessitate activation of the VTS in a matter of hours.

VTS Tampa has the responsibility of coordinating vessel traffic movements in the busy ports of Tampa, Manatee, and St. Petersburg. VTS Tampa's area includes the entrance to Tampa Bay via Egmont and Mullet Key Channels, the Sunshine Skyway Bridge, Old Tampa Bay, Hillsborough Bay, and the waters surrounding MacDill Air Force Base.

VTS Los Angeles/Long Beach assists in the safe navigation of vessels approaching the ports of LA/LB in an area extending 25 miles out to sea from Point Fermin (LAT 33 42.3'N LONG 118 17.6'W). The LA/LB VTS developed a unique partnership with the state of California, the Coast Guard, the Ports of Los Angeles-Long Beach, the Marine Exchange, and the local maritime community. With start up funds provided by the ports of Los Angeles and Long Beach, the VTS operations are supported by fees assessed against commercial vessels operating in the LA/LB area.

2910. Vessel Traffic Management and Information Systems

An emerging concept is that of Vessel Traffic Management and Information Services (VTMIS) wherein a VTS is only part of a larger and much more comprehensive infor-

mation exchange. Under this concept, not only can vessel traffic be managed from the standpoint of navigation safety and efficiency, but also tugs, pilots, line handlers, intermodal shipping operators, port authorities, customs and immigration, law enforcement, and disaster response agencies and others can use vessel transit information to enhance the delivery of their services.

A VTS need not be part of a VTMS, but it is logical

that no port needing the latter would be without the former. It is important to note that VTMS is a service, not a system, and requires no particular set of equipment or software. VTMS development and installations are proceeding in several busy ports and waterways worldwide, and mariners can expect this concept to be implemented in many more areas in the future.

REGULATED WATERWAYS

2911. Purpose and Authorities

In confined waterways not considered international waters, local authorities may establish certain regulations for the safe passage of ships and operate waterway systems consisting of locks, canals, channels, and ports. This generally occurs in especially busy or highly developed waterways which form the major constrictions on international shipping routes. The Panama Canal, St. Lawrence Seaway, and the Suez Canal represent systems of this type. Nearly all ports and harbors have a body of regulations concerning the operation of vessels within the port limits, particularly if locks and other structures are part of the system. The regulations covering navigation through these areas are typically part of a much larger body of regulations

relating to assessment and payment of tariffs and tolls, vessel condition and equipment, personnel, communications equipment, and many other factors. In general, the larger the investment in the system, the larger the body of regulations which control it will be.

Where a waterway separates two countries, a joint authority may be established to administer the regulations, collect tolls, and operate the system, as in the St. Lawrence Seaway.

Copies of the regulations are usually required to be aboard each vessel in transit. These regulations are available from the authority in charge or an authorized agent. Summaries of the regulations are contained in the appropriate volumes of the *Sailing Directions (Enroute)*.

CHAPTER 30

MARITIME SAFETY SYSTEMS

MARITIME SAFETY AND THE NAVIGATOR

3000. Introduction

The navigator's chief responsibility is the safety of the vessel and its crew. Fulfilling this duty consists mostly of ascertaining the ship's position and directing its course to avoid dangers. But accidents can happen to the most cautious, and the most prudent of navigators may experience an emergency which requires outside assistance. Distress incidents at sea are more likely to be resolved without loss of vessel and life if they are reported immediately. The more information that rescue authorities have, and the sooner they have it, the more likely it is that the outcome of a distress at sea will be favorable.

Global distress communication systems, ship reporting systems, emergency radiobeacons, commercial ship tracking and other technologies have greatly enhanced mariners' safety. Therefore, it is critical that mariners understand the

purpose, functions, and limitations of maritime safety systems as well as threats to maritime security.

The mariner's direct high-seas link to shoreside rescue authorities is the **Global Maritime Distress and Safety System (GMDSS)**, which was developed to both simplify and improve the dependability of communications for all ships at sea. GMDSS nicely compliments the operation of the U.S. Coast Guard's AMVER system, which tracks participating ships worldwide and directs them as needed to distress incidents. GMDSS and AMVER rely on radiotelephone or satellite communications for passing information. But even with normal communications disabled, a properly equipped vessel has every prospect of rapid rescue or aid if it carries a SOLAS-required Emergency Position Indicating Radiobeacon (EPIRB) and a Search and Rescue radar Transponder (SART). These systems are the subject of this chapter.

GLOBAL MARITIME DISTRESS AND SAFETY SYSTEM

3001. Introduction and Background

The Global Maritime Distress and Safety System (GMDSS) represents a significant improvement in maritime safety over the previous system of short range and high seas radio transmissions. Its many parts include satellite as well as advanced terrestrial communications systems. Operational service of the GMDSS began on February 1, 1992, with full implementation accomplished by February 1, 1999.

GMDSS was adopted in 1988 by amendments to the Conference of Contracting Governments to the **International Convention for the Safety of Life at Sea (SOLAS)**, 1974. This was the culmination of more than a decade of work by the International Maritime Organization (IMO) in conjunction with the International Telecommunications Union (ITU), International Hydrographic Organization (IHO), World Meteorological Organization (WMO), Inmarsat (International Maritime Satellite Organization), and others.

GMDSS offers the greatest advancement in maritime safety since the enactment of regulations following the Titanic disaster in 1912. It is an automated ship-to-ship, shore-to-ship and ship-to-shore communications system covering distress alerting and relay, the provision of **mari-**

time safety information (MSI), and routine communications. Satellite and advanced terrestrial systems are incorporated into a communications network to promote and improve safety of life and property at sea throughout the world. The equipment required on board ships depends on their tonnage and the area in which the vessel operates. This is fundamentally different from the previous system, which based requirements on vessel size alone. The greatest benefit of the GMDSS is that it vastly reduces the chances of ships sinking without a trace, and enables **search and rescue (SAR)** operations to be launched without delay and directed to the exact site of a maritime disaster.

3002. Ship Carriage Requirements

By the terms of the SOLAS Convention, the GMDSS provisions apply to cargo ships of 300 gross tons and over and ships carrying passengers on international voyages. Unlike previous shipboard carriage regulations that specified equipment according to size of vessel, the GMDSS carriage requirements stipulate equipment according to the area in which the vessel operates (and vessel size in some cases). These sea areas are designated as follows:

Sea Area A1 An area within the radiotelephone coverage of at least one VHF coast station in which continuous Digital Selective Calling is available, as may be defined by a Contracting Government to the 1974 SOLAS Convention. This area extends from the coast to about 20 miles offshore.

Sea Area A2 An area, excluding sea area A1, within the radiotelephone coverage of at least one MF coast station in which continuous DSC alerting is available, as may be defined by a Contracting Government. The general area is from the A1 limit out to about 100 miles offshore.

Sea Area A3 An area, excluding sea areas A1 and A2, within the coverage of an Inmarsat geostationary satellite in which continuous alerting is available. This area is from about 70°N to 70°S.

Sea Area A4 All areas outside of sea areas A1, A2 and A3. This area includes the polar regions, where geostationary satellite coverage is not available.

Ships at sea *must* be capable of the following functional GMDSS requirements:

1. Ship-to-shore distress alerting, by at least two separate and independent means, each using a different radio communication service
2. Shore-to-ship distress alerting
3. Ship-to-ship distress alerting
4. SAR coordination
5. On-scene communications
6. Transmission and receipt of emergency locating signals
7. Transmission and receipt of MSI
8. General radio communications
9. Bridge-to-bridge communications

To meet the requirements of the functional areas above the following is a list of the minimum communications equipment needed for all ships:

1. VHF radio capable of transmitting and receiving DSC on channel 70, and radio telephony on channels 6, 13 and 16
2. Radio receiver capable of maintaining a continuous Digital Selective Calling (DSC) watch on channel 70 VHF
3. Search and rescue transponders (SART). Only one SART is required if the vessel is under 500 gross tons. Two SARTs are required if the vessel is over

500 tons and must be capable of operating in the 9 GHz band (AIS SART meets carriage requirements).

4. Receiver capable of receiving NAVTEX broadcasts anywhere within NAVTEX range
5. Receiver capable of receiving SafetyNET anywhere NAVTEX is not available
6. Satellite emergency position indicating radiobeacon (EPIRB), manually activated and float-free self-activated
7. Two-way handheld VHF radios (two sets minimum on 300-500 gross tons cargo vessels and three sets minimum on cargo vessels of 500 gross tons and upward and on all passenger ships)

Additionally, each sea area has its own requirements under GMDSS which are as follows:

Sea Area A1

1. General VHF radio telephone capability
2. Free-floating satellite EPIRB
3. Capability of initiating a distress alert from a navigational position using DSC on either VHF, HF or MF; manually activated EPIRB; or Ship Earth Station (SES)

Sea Areas A1 and A2

1. Radio telephone MF radiotelephony or direct printing 2182 kHz, and DSC on 2187.5 kHz
2. Equipment capable of maintaining a continuous DSC watch on 2187.5 kHz
3. General working radio communications in the MF band (1605-4000 kHz), or Inmarsat SES
4. Capability of initiating a distress alert by HF (using DSC), manual activation of an EPIRB, or Inmarsat SES

Sea Areas A1, A2 and A3

1. Radio telephone MF 2182 kHz and DSC 2187.5 kHz.
2. Equipment capable of maintaining a continuous DSC watch on 2187.5 kHz
3. Inmarsat-A, -B or -C (class 2) or Fleet 77 SES Enhanced Group Call (EGC), or HF as required for sea area A4
4. Capability of initiating a distress alert by two of the following:

- a. Inmarsat-A, -B or -C (class 2) or Fleet 77 SES
- b. Manually activated EPIRB
- c. HF/DSC radio communication

Sea Area A4

1. HF/MF receiving and transmitting equipment for band 1605-27500 kHz using DSC, radiotelephone and direct printing
2. Equipment capable of selecting any safety and

distress DSC frequency for band 4000-27500 kHz, maintaining DSC watch on 2187.5, 8414.5 kHz and at least one additional safety and distress DSC frequency in the band

3. Capability of initiating a distress alert from a navigational position via the Polar Orbiting System on 406 MHz (manual activation of 406 MHz satellite EPIRB)

3003. The Inmarsat System

Inmarsat (International Maritime Satellite Organization), a key player within GMDSS, is an international corporation comprising over 75 international partners providing maritime safety communications for ships at sea. Inmarsat provides the space segment necessary for improving distress communications, efficiency and management of ships, as well as public correspondence services.

The basic components of the Inmarsat system include the Inmarsat **space segment**, **Land Earth Stations (LES)**, also referred to as **Coast Earth Stations (CES)**, and mobile **Ship Earth Stations (SES)**.

The Inmarsat space segment consists of 11 geostationary satellites. Four operational Inmarsat satellites provide primary coverage, four additional satellites (including satellites leased from the European Space Agency (ESA) and the International Telecommunications Satellite Organization (INTELSAT)) serve as spares and three remaining leased satellites serve as back-ups.

The polar regions are not visible to the operational satellites but coverage is available from about 75°N to 75°S. Satellite coverage (Figure 3003) is divided into four overlapping regions:

1. Atlantic Ocean - East (AOR-E)
2. Atlantic Ocean - West (AOR-W)
3. Pacific Ocean (POR)
4. Indian Ocean (IOR)

The LES's provide the link between the Space Segment and the land-based national/international fixed communications networks. These communications networks are funded and operated by the authorized communications authorities of a participating nation. This network links registered information providers to the LES. The data then travels from the LES to the Inmarsat **Network Coordination Station (NCS)** and then down to the SES's on ships at sea. The SES's provide two-way communications between ship and shore. **Inmarsat-A**, the original Inmarsat system, operates at a transfer rate of up to 64k bits per second and is telephone, telex and facsimile (fax) capable. The similarly sized **Inmarsat-B** system uses digital technology, also at rates to 64kbps. Fleet 77 service is also digital and operates at up to 64kbps.

Inmarsat-C provides a two-way **store and forward** data messaging capability (but no voice) at 600 bits per second and was designed specifically to meet the GMDSS

requirements for receiving MSI data on board ship. These units are small, lightweight and use an omni-directional antenna.

3004. Maritime Safety Information (MSI)

Major categories of MSI for both NAVTEX and SafetyNET are:

1. Navigational warnings
2. Meteorological warnings
3. Ice reports
4. Search and rescue information
5. Meteorological forecasts
6. Pilot service messages (not in the U.S.)
7. Electronic navigation system messages (i.e., GPS, DGPS, etc.)

Broadcasts of MSI in NAVTEX international service are in English, but may be in languages other than English to meet requirements of the host government.

3005. SafetyNET

SafetyNET is a broadcast service of Inmarsat-C's **Enhanced Group Call (EGC)** system. The EGC system (Figure 3005a) is a method used to specifically address particular regions or groups of ships. Its unique addressing capabilities allow messages to be sent to all vessels in both fixed geographical areas or to predetermined groups of ships. SafetyNET is a service designated by the IMO through which ships receive maritime safety information. The other service under the EGC system, called **FleetNET**, is used by commercial companies to communicate directly and privately with their individual fleets.

SafetyNET is an international shore to ship satellite-based service for the promulgation of distress alerts, navigational warnings, meteorological warnings and forecasts, and other safety messages. It fulfills an integral role in GMDSS as developed by the IMO. The ability to receive SafetyNET messages is required for all SOLAS ships that sail beyond coverage of NAVTEX (approximately 200 miles from shore).

SafetyNET can direct a message to a given geographic area based on EGC addressing. The area may be fixed, as in the case of a NAVAREA or weather forecast area, or it may be uniquely defined by the originator. This is particularly useful for messages such as local storm warnings or focused shore to ship distress alerts.

SafetyNET messages can be originated by a **Registered Information Provider** anywhere in the world and broadcast to the appropriate ocean area through an Inmarsat-C LES. Messages are broadcast according to their priority (i.e. Distress, Urgent, Safety, and Routine).

Virtually all navigable waters of the world are covered by the operational satellites in the Inmarsat system. Each satellite broadcasts EGC traffic on a designated channel.

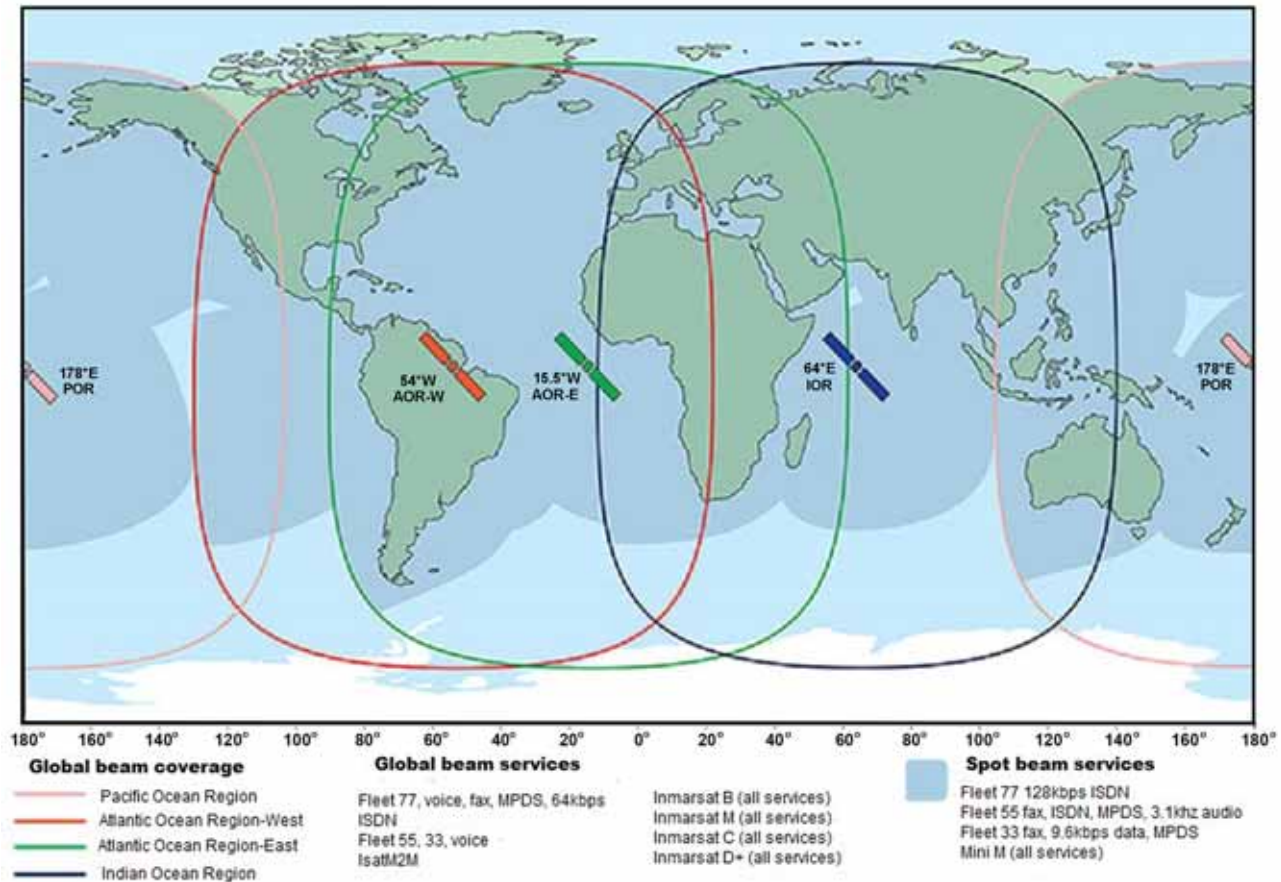

Figure 3003. The four regions of Inmarsat coverage.

Any ship sailing within the coverage area of an Inmarsat satellite will be able to receive all the SafetyNET messages broadcast over this channel. The EGC channel is optimized to enable the signal to be monitored by SES's dedicated to the reception of EGC messages. This capability can be built into other standard SES's. It is a feature of satellite communications that reception is not generally affected by the position of the ship within the ocean region, atmospheric conditions, or time of day.

Messages can be transmitted either to geographic areas (area calls) or to groups of ships (group calls):

1. **Area calls** can be to a fixed area such as one of the 16 NAVAREA's or to a temporary geographic area selected by the originator (circular or rectangular). Area calls will be received automatically by any ship whose receiver has been set to one or more fixed areas.
2. **Group calls** will be received automatically by any ship whose receiver acknowledges the unique group identity associated with a particular message.

Reliable delivery of messages is ensured by forward error correction techniques. Experience has demonstrated

that the transmission link is generally error-free and low error reception is achieved under normal circumstances.

Given the vast ocean coverage by satellite, some form of discrimination and selectivity in printing the various messages is required. Area calls are received by all ships within the ocean region coverage of the satellite; however, they will be printed only by those receivers that recognize the fixed area or the geographic position in the message. The message format includes a **preamble** that enables the microprocessor in a ship's receiver to decide to print those MSI messages that relate to the present position, intended route or a fixed area programmed by the operator. This preamble also allows suppression of certain types of MSI that are not relevant to a particular ship. As each message will also have a unique identity, the reprinting of messages already received correctly is automatically suppressed.

MSI is promulgated by various information providers around the world. Messages for transmission through the SafetyNET service will, in many cases, be the result of coordination between authorities. Information providers will be authorized by IMO to broadcast via SafetyNET. Authorized information providers are:

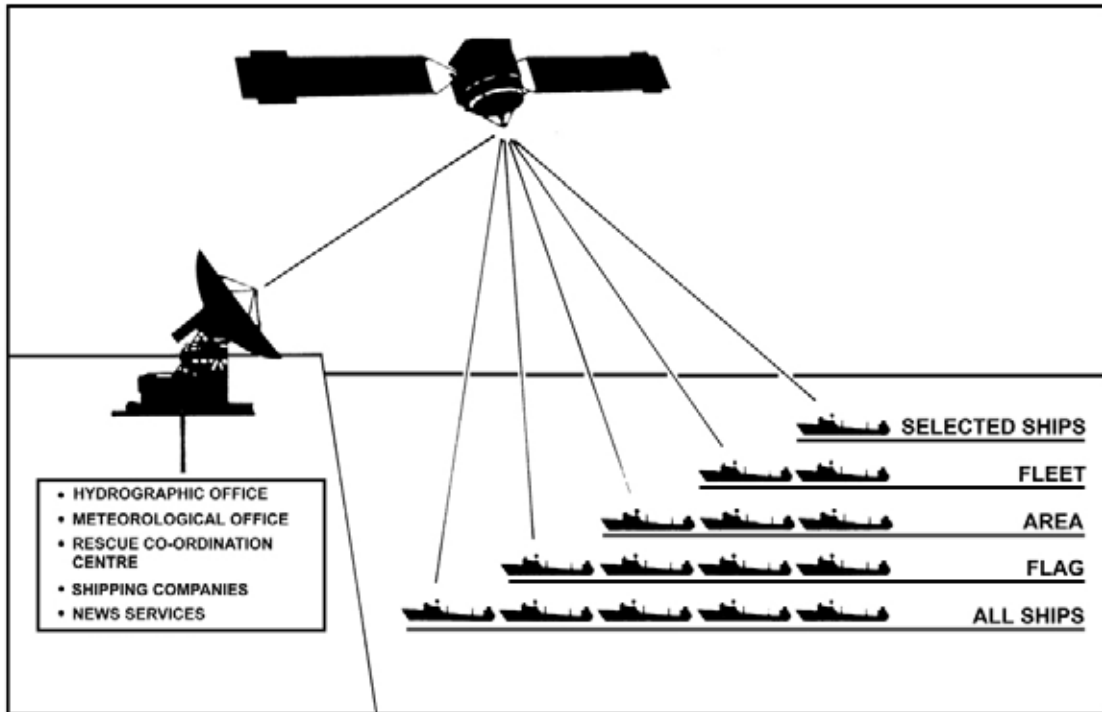

Figure 3005a. SafetyNET EGC concept.

1. National hydrographic offices for navigational warnings
2. National weather services for meteorological warnings and forecasts
3. Rescue Coordination Centers (RCC's) for ship-to-shore distress alerts and other urgent information
4. In the U.S., the International Ice Patrol (IIP) for North Atlantic ice hazards

Each information provider prepares their SafetyNET messages with certain characteristics recognized by the EGC service. These characteristics, known as “C” codes are combined into a generalized message header format as follows: C1:C2:C3:C4:C5. Each “C” code controls a different broadcast criterion and is assigned a numerical value according to available options. A sixth “C” code, “C0” may be used to indicate the ocean region (i.e., AOR-E, AOR-W, POR, IOR) when sending a message to an LES which operates in more than one ocean region. Because errors in the header format of a message may prevent its being broadcast, MSI providers must install an Inmarsat SafetyNET receiver to monitor the broadcasts it originates. This also ensures quality control.

The “C” codes are transparent to the mariner, but are used by information providers to identify various transmitting parameters. C1 designates the message priority, either distress to urgent, safety, or routine. MSI messages will always be at least at the safety level. C2 is the service code or type of message (for example, long range

NAVAREA warning or coastal NAVTEX warning). It also tells the receiver the length of the address (the C3 code) it will need to decode. C3 is the address code. It can be the two-digit code for the NAVAREA number for instance, or a ten-digit number to indicate a circular area for a meteorological warning. C4 is the repetition code which instructs the LES when to send the message to the NCS for actual broadcast. A six minute echo (repeat) may also be used to ensure that an urgent (unscheduled) message has been received by all ships affected. C5 is a constant and represents a presentation code, International Alphabet number 5, “00”.

Broadcasts of MSI in the international SafetyNET service must be in English, but may be supplemented by other languages to meet requirements of the host government.

The International SafetyNET Manual is available online via the link provided in Figure 3005b.



Figure 3005b. International SafetyNET Manual.
https://www.iho.int/mtg_docs/com_wg/CPRNW/WWNWS1/WWNWS1-4-3-1.doc

3006. NAVTEX

NAVTEX is a maritime radio warning system consisting of a series of coast stations transmitting radio teletype (standard narrow-band direct printing, called **Sitor** for Simplex Telex Over Radio) safety messages on the internationally standard medium frequency of 518 kHz (490kHz local language). It is a GMDSS requirement for the reception of MSI in coastal and local waters. Coast stations transmit during previously arranged time slots to minimize mutual interference. Routine messages are normally broadcast four times daily. Urgent messages are broadcast upon receipt, provided that an adjacent station is not transmitting. Since the broadcast uses the medium frequency band, a typical station service radius ranges from 100 to 500 NM day and night (although a 200 mile rule of thumb is applied in the U.S.). Interference from or receipt of stations further away occasionally occurs at night.

Each NAVTEX message broadcast contains a four-character header describing: identification of station (first character), message content or type (second character), and message serial number (third and fourth characters). This header allows the microprocessor in the shipboard receiver to screen messages from only those stations relevant to the user, messages of subject categories needed by the user and messages not previously received by the user. Messages so screened are printed as they are received, to be read by the mariner when convenient. All other messages are suppressed. Suppression of unwanted messages is becoming more and more a necessity to the mariner as the number of messages, including rebroadcast messages, increases yearly. With NAVTEX, a mariner will not find it necessary to listen to, or sift through, a large number of non-relevant data to obtain the information necessary for safe navigation.

The NAVTEX receiver is a small unit with an internal printer, which takes a minimum of room on the bridge. Its antenna is also of modest size, needing only a receive capability.

Valuable information regarding NAVTEX and navigational warnings can be found in *Pub No. 117 Radio Navigation Aids* via the link provided in Figure 3006.



Figure 3006. NGA- Radio Navigational Aids (Pub. No. 117).

https://msi.nga.mil/NGAPortal/MSI.portal?_nfpb=true&st=&_pageLabel=msi_portal_page_62&pubCode=0009

3007. Digital Selective Calling (DSC)

Digital Selective Calling (DSC) is a system of digitized radio communications which allows messages to be targeted to all stations or to specific stations, allows for unattended and automated receipt and storage of messages for later retrieval, and permits the printing of messages in hardcopy form. All DCS calls automatically include error-checking signals and the identity of the calling unit. Digital codes allow DSC stations to transmit and receive distress messages, transmit and receive acknowledgments of distress messages, relay distress messages, make urgent and safety calls, and initiate routine message traffic.

Each unit has a MAYDAY button which allows the instant transmittal of a distress message to all nearby ships and shore stations. The location of the distress will be automatically indicated if the unit is connected to a GPS receiver. Each unit must be registered with the Coast Guard and have unique identifier programmed into it. Distress alerts can be sent on only one or as many as six channels consecutively on some units.

Listening watch on 2182 kHz ended with implementation of GMDSS in 1999. When DSC has been implemented worldwide, the traditional listening watch on Channel 16 VHF will no longer be necessary. The introduction of DSC throughout the world is expected to take a number of years.

There are four basic types of DSC calls:

- Distress
- Urgent
- Safety
- Routine

Distress calls are immediately received by rescue authorities for action, and all vessels receiving a distress call are alerted by an audible signal.

Each DSC unit has a unique **Maritime Mobile Service Identity (MMSI)** code number, which is attached to all outgoing messages. The MMSI number is a nine-digit number to identify individual vessels, groups of vessels, and coast stations. Ship stations will have a leading number consisting of 3 digits which identify the country in which the ship is registered, followed by a unique identifying number for the vessel. A group of vessels will have a leading zero, followed by a unique number for that group. A coast station will have 2 leading zeros followed by a code number. Other codes may identify all stations, or all stations in a particular geographic area.

DSC frequencies are found in the VHF, MF and HF bands. Within each band except VHF, one frequency is allocated for distress, urgent, and safety messages. Other frequencies are reserved for routine calls. In the VHF band, only one channel is available, Channel 70 (156.525 MHz), which is used for all calls. In the MF band, 2187.5 kHz and 2189.5 kHz are reserved for distress/safety, and 2177 kHz for ship-to-ship. 2189.5 kHz (in conjunction with 2177

kHz) is for routine ship-to-shore calls.

3008. Using DSC

A distress call consists of a Format Specifier--Distress; the MMSI code; the nature of the distress (selected from a list: fire/explosion, flooding, collision, grounding, listing, sinking, disabled/adrift, or abandoning ship; defaults to Undesignated); the time of the call, and the format for subsequent communications (radiotelephone or NDBP). Once activated, a distress signal is repeated automatically every few minutes until an acknowledgment is received or the function is switched off. As soon as an acknowledgment is received by the vessel in distress, it must commence communications with an appropriate message by radiotelephone or NDBP according to the format:

“MAYDAY”
 MMSI CODE NUMBER AND CALL SIGN
 NAME OF VESSEL
 POSITION
 NATURE OF DISTRESS
 TYPE OF ASSISTANCE NEEDED
 OTHER INFORMATION

Routine calls should be made on a channel reserved for non-distress traffic. Once made, a call should not be repeated, since the receiving station either received the call and stored it, or did not receive it because it was not in service. At least 5 minutes should elapse between calls by vessels on the first attempt, then at 15 minute minimum intervals.

To initiate a routine ship to shore or ship to ship call to a specific station, the following procedures are typical (consult the operator’s manual for the equipment for specific directions):

- Select the appropriate frequency
- Select or enter the MMSI number of the station to be called
- Select the category of the call

- Select subsequent communications method (R/T, NDBP)
- Select proposed working channel (coast stations will indicate vacant channel in acknowledgment)
- Select end-of-message signal (RQ for acknowledgment required)
- Press <CALL>

The digital code is broadcast. The receiving station may acknowledge receipt either manually or automatically, at which point the working channel can be agreed on and communications begin.

Watchkeeping using DSC consists of keeping the unit ON while in the appropriate Sea Area. DSC watch frequencies are VHF Channel 70, 2187.5 kHz, 8414.5 kHz, and one HF frequency selected according to the time of day and season. Coast stations maintaining a watch on DCS channels are listed in *NGA Pub. 117 Radio Navigational Aids* and other lists of radio stations.

3009. The Automated Mutual-Assistance Vessel Rescue System (AMVER)

AMVER is an international maritime mutual assistance program that coordinates search and rescue efforts around the world. It is voluntary, free of charge, and endorsed by the IMO. The AMVER system is discussed in detail in Chapter 31. The AMVER website can be accessed through the link provided in Figure 3009.



Figure 3009. AMVER website. www.amver.com

EMERGENCY POSITION INDICATING RADIOBEACONS (EPIRB’S)

3010. Description and Capabilities

Emergency Position Indicating Radiobeacons (EPIRB’s) are designed to save lives by automatically alerting rescue authorities and indicating the distress location. EPIRB types are described below (Table 3010a):

121.5/243 MHz EPIRB’s (Class A, B, S): These are the most common and least expensive type of EPIRB, designed to be detected by overflying commercial or military aircraft.

The IMO and the International Civil Aviation Organization (ICAO) have announced plans to eventually

terminate the processing distress signals for 121.5/243 MHz EPIRBs. Support for Class A, B, and S EPIRB’s will be discontinued at some unannounced time in the future due to the high number of false alarms and the superiority of other systems.

Satellites were designed to detect these EPIRB’s, but are limited for the following reasons:

1. Satellite detection range is limited for these EPIRB’s (satellites must be within line of sight of both the EPIRB and a ground terminal for detection to occur).
2. EPIRB design and frequency congestion cause a high false alarm rate (over 99%); consequently,

confirmation is required before SAR forces deploy.

3. EPIRB's manufactured before October 1988 may have design or construction problems (e.g. some models will leak and cease operating when immersed in water) or may not be detectable by satellite.

406 MHz EPIRB's (Category I, II): The 406 MHz EPIRB was designed to operate with satellites. Its signal allows authorities to locate the EPIRB much more accurately than 121.5/243 MHz devices and identify the individual vessel anywhere in the world. There is no range limitation. These devices also include a 121.5 MHz homing signal, allowing aircraft and rescue vessels to quickly locate the vessel in distress once underway. These are the only type of EPIRB which must be tested by Coast Guard-approved independent laboratories before they can be sold for use in the United States.

An automatically activated, float-free version of this EPIRB has been required on SOLAS vessels (cargo ships over 300 tons and passenger ships on international voyages) since August 1, 1993. The Coast Guard requires U.S. commercial fishing vessels to carry this device, and requires the

same for other U.S. commercial uninspected vessels which travel more than 3 miles offshore.

Inmarsat-E EPIRB's: Inmarsat-E EPIRB's operate on 1.6 GHz (L-band) and transmit a distress signal to Inmarsat geostationary satellites, which includes a registered identity similar to that of the 406 MHz EPIRB, and a location derived from a GPS navigational satellite receiver inside the EPIRB. Inmarsat-E EPIRB's may be detected anywhere in the world between 70°N and 70°S. Since geostationary satellites are used, alerts are transmitted almost instantly to a RCC associated with the Inmarsat CES receiving the alert. The distress alert transmitted by an Inmarsat-E EPIRB is received by two CES's in each ocean region, giving 100 percent duplication for each ocean region in case of failures or outages associated with any of the CES's. Alerts received over the Inmarsat Atlantic Ocean Regions are routed to the U.S. Coast Guard Atlantic Area command center in Portsmouth, and alerts received over the Inmarsat Pacific Ocean Region are routed to the U.S. Coast Guard Pacific Area command center in Alameda. This type of EPIRB is designated for use in the GMDSS, but it is not sold in the United States or approved for use by U.S. flag vessels.

Type	Frequency	Description
Class A	121.5/243 MHz	Float-free, automatic activating, detectable by aircraft and satellite. Coverage limited (see Table 3010b).
Class B	121.5/243 MHz	Manually activated version of Class A.
Class S	121.5/243 MHz	Similar to Class B, except that it floats, or is an integral part of a survival craft.
Category I	406 MHz	Float-free, automatically activated. Detectable by satellite anywhere in the world.
Category II	406 MHz	Similar to Category I, except manually activated.
Inmarsat-E	1646 MHz	Float-free, automatically activated EPIRB. Detectable by Inmarsat geostationary satellite.

Table 3010a. EPIRB classifications.

Feature	406 MHz EPIRB	121.5/243 MHz EPIRB
Frequencies	406.025 MHz (locating) 121.500 MHz (homing)	243.000 MHz (military)
Primary Function	Satellite alerting, locating, identification of distressed vessels.	Transmission of distress signal to passing aircraft and ships.
Distress Confirmation	Positive identification of coded beacon; each beacon signal is a coded, unique signal with registration data (vessel name, description, and telephone number ashore, assisting in confirmation).	Virtually impossible; no coded information, beacons often incompatible with satellites; impossible to know if signals are from EPIRB, ELT, or non-beacon source.
Signal	Pulse digital, providing accurate beacon location and vital information on distressed vessel.	Continuous signal allows satellite locating at reduced accuracy; close range homing.

Table 3010b. Comparison of 121.5/406 MHz and 121.5/243 MHz EPIRB's.

<i>Feature</i>	<i>406 MHz EPIRB</i>	<i>121.5/243 MHz EPIRB</i>
Signal Quality	Excellent; exclusive use of 406 MHz for distress beacons; no problems with false alerts from non-beacon sources.	Relatively poor; high number of false alarms caused by other transmitters in the 121.5 MHz band.
Satellite Coverage	Global coverage, worldwide detection; satellite retains beacon data until next Earth station comes into view.	Both beacon and LUT must be within coverage of satellite; detection limited to line of sight.
Operational Time	48 hrs. at -20°C.	48 hrs. at -20°C.
Output Power	5 watts at 406 MHz, 0.025 watts at 121.5 MHz.	0.1 watts average.
Strobe Light	High intensity strobe helps in visually locating search target.	None.
Location Accuracy (Search Area) and Time Required	1 to 3 miles (10.8 sq. miles); accurate position on first satellite overflight enables rapid SAR response, often within 30 min.	10 to 20 miles (486 sq. miles); SAR forces must wait for second system alert to determine final position before responding (1 to 3 hr. delay).

Table 3010b. Comparison of 121.5/406 MHz and 121.5/243 MHz EPIRB's.

Mariners should be aware of the differences between capabilities of 121.5/243 MHz and 121.5/406 MHz EPIRB's, as they have implications for alerting and locating of distress sites, as well as response by SAR forces. See Table 3010b. The advantages of 121.5/406 MHz devices are substantial, and are further enhanced by EPIRB-transmitted registration data on the carrying vessel. Owners of 121.5/406 MHz EPIRB's furnish registration information about their vessel, type of survival gear, and emergency points of contact ashore, all of which greatly enhance the quality of the response. The database for U.S. vessels is maintained by the National Oceanographic and Atmospheric Administration, and is accessed worldwide by SAR authorities to facilitate SAR response.

3011. Testing EPIRB's

EPIRB owners should periodically check for water tightness, battery expiration date, and signal presence. FCC rules allow Class A, B, and S EPIRB's to be turned on briefly (for three audio sweeps, or 1 second only) during the first 5 minutes of any hour. Signal presence can be detected by an FM radio tuned to 99.5 MHz, or an AM radio tuned to any vacant frequency and located close to an EPIRB. All 121.5/406 MHz EPIRB's have a self-test function that should be used in accordance with manufacturers' instructions at least monthly.

3012. The Cospas-Sarsat System

COSPAS is a Russian acronym for "Space System for Search of Distressed Vessels"; SARSAT signifies "Search And Rescue Satellite-Aided Tracking." Cospas-Sarsat is an international satellite-based search and rescue system

established by the U.S., Russia, Canada, and France to locate emergency radiobeacons transmitting on the frequencies 121.5, 243, and 406 MHz. Since its inception, the Cospas-Sarsat system (SARSAT satellite only) has contributed to saving over 39,000 lives.

The USCG receives data from Maritime Rescue Coordination Center (MRCC) stations and SAR Points of Contact (SPOC). See Table 3012.

<i>Country</i>	<i>Location</i>	<i>Designator</i>
Algeria	Algiers	ALMCC
Argentina	El Palomar	ARMCC
Australia	Canberra	AUMCC
Brazil	San Paulo	BBMCC
Canada	Trenton	CMCC
Chile	Santiago	CHMCC
China	Beijing	CNMCC
France	Toulouse	FMCC
Greece	Athens	GRMCC
Hong Kong	Hong Kong	HKMCC
India	Bangalore	INMCC
Italy	Bari	ITMCC
Indonesia	Jakarta	IONCC
Japan	Tokyo	JAMCC
New Zealand	Canberra, Aus	AUMCC
Nigeria	Abuja	NIMCC
Norway	Bodo	NMCC
Peru	Calloa	PEMCC
Republic of Korea	Incheon	KOMCC
Russian Federation	Moscow	CMC
Saudi Arabia	Jiddah	SAMCC
Singapore	Singapore	SIMCC
Spain	Maspalomas	SPMCC
South Africa	Cape Town	SAMCC
Thailand	Bangkok	THMCC

Table 3012. Participants in Cospas-Sarsat system.

<i>Country</i>	<i>Location</i>	<i>Designator</i>
Turkey	Ankara	TRMCC
United Kingdom	Kinloss	UKMCC
United States	Suitland	USMCC
Vietnam	Haiphong	VNMCC

Table 3012. Participants in Cospas-Sarsat system.

3013. Operation of the Cospas-Sarsat System

If an EPIRB is activated, Cospas-Sarsat picks up the signal, locates the source and passes the information to a land station. From there, the information is relayed to Rescue Coordination Centers, rescue vessels and nearby ships. This constitutes a one-way only communications system, from the EPIRB via the satellite to the rescuers. It employs low altitude, near polar orbiting satellites and by exploiting the Doppler principle, locates the 406 MHz EPIRB within about two miles. Due to the low polar orbit, there may be a delay in receiving the distress message unless the footprint of the satellite is simultaneously in view with a monitoring station. However, unlike SafetyNET, worldwide coverage is provided.

As a satellite approaches a transmitting EPIRB, the frequency of the signals it receives is higher than that being transmitted; when the satellite has passed the EPIRB, the received frequency is lower. This creates a notable Doppler shift. Calculations which take into account the Earth's rotation and other factors then determine the location of the EPIRB.

Each 406 MHz EPIRB incorporates a unique identification code. Once the satellite receives the beacon's signals, the Doppler shift is measured and the beacon's digital data is recovered from the signal. The information is time-lagged, formatted as digital data and transferred to the repeater downlink for real time transmission to a local user

terminal. The digital data coded into each 406 MHz EPIRB's memory indicates the identity of the vessel to SAR authorities. They can then refer to the EPIRB registration database for information about the type of vessel, survival gear carried aboard, whom to contact in an emergency, etc. The data includes a maritime identification digit (MID, a three digit number identifying the administrative country) and either a ship station identifier (SSI, a 6 digit number assigned to specific ships), a ship radio call sign or a serial number to identify the ship in distress.

EPIRBs can now be purchased with internal GPS units (GPIRBs). Their locations are more accurate than the Doppler shift unit. Their signal can also be picked up by GEOS satellites and the position accurately determined.

3014. Alarm, Warning, and Alerting Signals

For MF (i.e. 2182 kHz), the signal consists of either (1) a keyed emission modulated by a tone of 1280 Hz to 1320 Hz with alternating periods of emission and silence of 1 to 1.2 seconds each; or (2) the radiotelephone alarm signal followed by Morse code B (— •••) and/or the call sign of the transmitting ship, sent by keying a carrier modulated by a tone of 1300 Hz or 2200 Hz. For VHF (i.e. 121.5 MHz and 243 MHz), the signal characteristics are in accordance with the specifications of Appendix 37A of the ITU Radio Regulations. For 156.525 MHz and UHF (i.e. 406 MHz to 406.1 MHz and 1645.5 MHz to 1646.5 MHz), the signal characteristics are in accordance with CCIR recommendations.

The purpose of these signals is to help determine the position of survivors for SAR operations. They indicate that one or more persons are in distress, may no longer be aboard a ship or aircraft, and may not have a receiver available.

AUTOMATIC IDENTIFICATION SYSTEMS

3015. Development and Purpose

Automatic Identification System (AIS) is a navigation-communication protocol used in the maritime VHF-FM band, to autonomously exchange real-time navigation information amongst other AIS users or stations. Given that AIS is digital protocol, it facilitates that its data can -but not currently required to-be used or portrayed on other systems, such as ECDIS, radar, VTS monitors, personal computers, shore-side web services, etc.

Upon proliferation of regional (and disparate) tracking systems in the early 1990 (i.e. Dover Straits, Panama Canal, Sweden, Prince William Sound, AK), various member entities exhorted IMO to consider the development of a universal tracking system, which in 1998 led to the IMO Marine Safety Committee to formally agree to and adopt

Performance Standards for a Universal Shipborne Automatic Identification System (later to be solely known as AIS), which use was mandated in 2000 on all tankers, seagoing passenger and cargo ships (those over 300 GT), via an amendment to the Safety of Life at Sea Convention (SOLAS Regulation V/19.2.4). Since then, AIS carriage requirements have expanded domestically and on smaller vessels; particularly in the United States which requires AIS on all commercial self-propelled vessels of sixty-five feet or greater, most commercial towboats, and any vessel moving certain dangerous cargoes or flammable in bulk.

The IMO (Resolution MSC74(69)) defines the primary functions or purposes of AIS as:

1. in ship-to-ship mode, for collision avoidance;
2. in a ship-to-shore mode, as a tool for vessel traffic management, and,

3. a means to obtain specific data about ships, and their cargo, operating in coastal waters.

AIS devices are designed to operate autonomously, without user intervention or external infrastructure or signals, as transponder require; albeit they can be interrogated (polled) or tele-commanded to report faster or not all). AIS rely upon time-division multiple access (TDMA) procedures. The VHF data link (VDL) is divided into 2,500 equal slots of time per channel to reserve or schedule its transmissions, which it does randomly accessing a free slot, when available. What makes AIS unique to cellular telephones that use TDMA, is that certain AIS devices (i.e. Class A, Class B-SO) self-organize themselves on the VDL. So rather the 'dropping a call' as cell-phone users may experience when they go beyond a cell tower range or when the cell therein is beyond capacity, each AIS acts as its own cell tower and coordinates its reception so to favor AIS transmission that are closest to themselves, and which pose the greater collision risk.

The range of AIS-as with all VHF (line-of-sight) systems-is mostly affected by antenna height; however, since VHF-FM wavelengths are slightly longer than radars, AIS signals tend to cross land and other obstructions moderately well. At sea, an AIS on the water can usually be seen at 3-4 miles, from a lifeboat at 6-8 miles, from fishing boats and pleasure craft at 8-12 miles, and, from large or higher ships at 15-30 miles. Given that its transmissions are line of sight, AIS can also be received from far ashore (25-50 miles out) and from satellite (1,000 miles).

Each IMO required AIS device consists of a: VHF transmitter; three receivers, two dedicated to AIS transmission, and another backwards compatible to VHF DSC (Ch. 70); a VHF and GPS antenna; an internal GPS for timing and positioning; a built in integrity test (BIIT) processor; a minimal keyboard display (MKD); two input-output interfaces, and, at least one output interface.

3016. Classes and Reporting

There are two classes of shipborne AIS transceivers: Class A devices which meet all IMO standards and Class B devices which are intended for non-compulsory use. Each AIS transmission (message) denotes the time of transmission and its source ID; a unique 9-digit Maritime Mobile Station Identity (MMSI) number. In addition, Class A devices transmit the following data, autonomously and continuously every 2-10 seconds (dependent on speed and changing course) and every three minutes when at anchor or moored (if it navigation status has been updated to reflect so), at a power of 12.5 watts:

- Navigation status: underway, anchored, not under command, etc. (manually selected)
- Lat. and long. to 1/10,000 minute
- Course over ground
- Speed over ground Position accuracy; source, i.e. GPS,

GLONAS, INS, manually entered, etc.; and, whether Receiver Autonomous Integrity Monitoring (RAIM) is used True heading, to 1/10 degree (via external gyro or transmitting heading device (THD), if connected)

- Rate of turn indication (if connected)

In addition, the Class A AIS will transmit, static and voyage related data, every six minutes:

- IMO number, a unique identifier related to ship's hull
- Radio call sign.
- Name of ship, up to 20 characters
- Type of ship, from predefined list of types
- Dimensions of ship, to nearest meter (derived from the positioning system antenna location)
- Source of positioning system, i.e. GPS, GLONAS, Integrated Navigation System (INS), manually inputted, etc.
- Static Draft, to 0.1 meter; air draft is not defined
- Destination, to 20 characters
- ETA: month, day, hour, and minute in UTC.

There are two variants of Class B AIS devices: Self-Organizing (same as Class A) or Carrier-Sense Mode (only transmit if they 'sense' a free slot is available) devices. Both are interoperable with other AIS devices, but, dissimilar to Class A devices in that they operate at a lower power (Class B-SO @ 5 Watts; Class B0-CS @ 2 Watts) and either every 5-15 seconds (Class B-SO) or at a 30 second fixed reporting rate; and, do not support external sensors (i.e. gyro, rate of turn indicator, etc.); or report their IMO number, destination, static draft, and navigational status; or have the facilities to transmit safety text messages.

Since the advent of the IMO AIS mandate, AIS technology has expanded to other devices. There now exists AIS dedicated for use onboard Search and Rescue (SAR) aircraft; as shore stations that perform as a network base station; co-located on an AIS Aid to Navigation (ATON or AtoN) or remotely used to transmit ATON information (and its health and status) where one does not physically exist, that is a Virtual ATON; and, as AIS locating devices, such as AIS EPIRB, AIS Man-overboard devices, and AIS Search and Rescue Transmitter (AIS-SART). Each unique type of AIS device can be identified by its MMSI format: 111YYYXXX for SAR aircraft AIS; 00YYYXXXX for AIS Base Stations; 99YYYXXXX for AIS ATON; 970YYYXXXX for AIS-SART; 9702YXXXX for MOB-AIS; 974YYXXXX for EPIRB-AIS.

AIS locating devices operate differently than most other AIS devices, using 'burst behavior'. To facilitate their locating, these devices transmit a pre-formatted safety text message which states whether the locating device is 'ACTIVE' or under 'TEST'. If the former, they will also transmit 7 position reports per minute, increasing the likelihood that at least one is transmitted on the crest of swell or wave. The great benefit of AIS locating devices is the each transmission includes the device's location, the SAR response unit does not need to continuously hone in or tediously adjust di-

rection finding antennas as is required to locate other beacons or radar transponders; the latter is discussed in the

following section.

SEARCH AND RESCUE RADAR TRANSPONDERS/TRANSMITTERS

3017. Operational Characteristics

There are two variants of Search and Rescue Transmitters: one that operates on AIS channels (see Section 3020), and the other that operates as a radar transponder, hereinafter SART. Operating much like a RACON, the **Search and Rescue Radar Transponder (SART)** is a passive rescue device which, when it senses the pulse from a radar operating in the 9 GHz frequency band, emits a series of pulses in response, which alerts the radar operator that some sort of maritime distress is in progress. Further, the SART signal allows the radar operator to home in on the exact location of the SART. The SART can be activated manually, or will activate automatically when placed in water.

The SART signal appears on the radar screen as a series of 12 blips, each 0.64 nautical miles apart. As the vessel or aircraft operating the radar approaches the SART location, the blips change to concentric arcs, and within about a mile of the SART become concentric circles, centered on the SART.

Because the SART actively responds to radar pulses, it also informs its user, with an audible or visual signal, that it is being triggered. This alerts the user in distress that there is an operating radar in the vicinity, whereupon they may send up flares or initiate other actions to indicate their position.

Approved SART's operate in standby mode for at least 96 hours and actively for at least 8 hours. Because the SART signal is stronger than any surrounding radar returns, it will be easily sensed by any nearby radar. But because it is much weaker than the radar, its own range is the limiting factor in detection.

3018. Factors Affecting SART Range

SART range is affected by three main factors. First, the type of radar and how it is operated is most important. Larger vessels with powerful, high-gain antennae, set higher above sea level, will trigger and detect the SART signal sooner than low-powered radars set closer to sea level. The radar should be set to a range of 12 or 6 miles for best indication of a SART's signal, and should not have too narrow a receive bandwidth, which might reduce the strength of the received signal.

Second, weather is a factor in SART range. A flat calm might cause multipath propagation and distort the SART's signal. Heavy seas may cause the SART signal to be received intermittently as the transponder falls into the troughs of the seas. Careful adjustment of the sea and rain clutter controls will maximize the SART's received signal strength.

Third, the height of the SART will greatly affect the range, because the signal obeys the normal rules for radio waves in its spectrum and does not follow the curvature of the earth, except for a small amount of refraction. Tests indicate that a SART floating in the sea will have a range of about 2 nautical miles when triggered by a radar mounted 15 meters above sea level. At a height of 1 meter, range increases to about 5 miles. To an aircraft actively searching for a SART at an altitude of 3,000 feet, the range increases to about 40 miles.

3019. Operating the Radar for SART Detection

Only an X-band (3 cm) radar can trigger and sense a SART. An S-Band (10 cm) radar will neither trigger nor detect a SART. Normally, an X-band radar will sense a SART at about 8 nm. When triggered by an incoming radar signal, the SART will transmit a return signal across the entire 3 cm radar frequency band. The first signal is a rapid 0.4 microsecond sweep, followed by a 7.5 microsecond sweep, repeated 12 times. This will cause a series of 12 blips on the radar, spaced 0.64 nm apart. See Figure 3019a.



Figure 3019a. SART 12-dot blip code.

For best reception, the radar should be set to medium bandwidth and to the 12 or 6 mile range. Too narrow a bandwidth will cause the SART signal to be weakened, as the radar is not sensing the entire SART pulse. The radar operator's manual should be consulted for these settings.

Less expensive radars may not be able to change settings.



Figure 3019b. SART arcs.

As the range to the SART decreases to about 1 nm, the initial 0.4 microsecond sweeps may become visible as weaker and smaller dots on the radar screen. When first sensed, the first blip will appear about 0.6 miles beyond the actual location of the SART. As range decreases, the blips will become centered on the SART.

As the SART is approached more closely, the blips appearing on the radar become concentric arcs centered on the SART itself. The arcs are actually caused by the radar return of side lobes associated with the radar signal. While use of the sea return or clutter control may decrease or eliminate these arcs, it is often best to retain them, as they indicate the proximity of the SART. See Figure 3019b. Eventually the arcs become rings centered on the SART, as in Figure 3019c.

On some radars it may be possible to detune the radar signal in situations where heavy clutter or sea return obscures the SART signal. With the Automatic Frequency Control (AFC) on, the SART signal may become more visible, but the radar should be returned to normal operation as soon as possible. The gain control should usually be set to normal level for best detection, with the sea clutter control



Figure 3019c. SART rings.

at its minimum and rain clutter control in normal position for the ambient conditions.

3020. Automatic Identification System - Search and Rescue Transmitter (AIS-SART)

January 1, 2010 the AIS-SART was added to GMDSS regulations as an alternative to the Radar SART. With the approval from IMO SOLAS Amendment in Resolution MSC 256(84) ship owners may choose either Radar SART or AIS SART to be carried on the vessel. AIS-SART's have a built in GPS and transmit an alert message including the vessel ID and GPS position from the AIS tracking system. This information will appear on an AIS equipped vessel's chart plotter or ECDIS which differs from the traditional SART which displays on the Radar. The much lower operating frequency (160 MHz vs 9000MHz) from the AIS SART significantly increases the range of the signal and because VHF can propagate around land, the signal may be seen "around corners". This is an improvement over Radar SART, particularly in areas of heavily incised coastlines and/or island archipelagos.

SHIP TRACKING

3021. Long-Range Identification and Tracking (LRIT)

The Long-Range Identification and Tracking (LRIT) system, designated by the International Maritime Organization (IMO), provides for the global identification and tracking of ships.

The obligations of ships to transmit LRIT information and the rights and obligations of SOLAS Contracting Governments and of Search and rescue services to receive LRIT information are established in regulation V/19-1 of the 1974 SOLAS Convention.

The LRIT system consists of the shipborne LRIT infor-

mation transmitting equipment, the Communication Service Provider(s), the Application Service Provider(s), the LRIT Data Center(s), including any related Vessel Monitoring System(s), the LRIT Data Distribution Plan and the International LRIT Data Exchange. Certain aspects of the performance of the LRIT system are reviewed or audited by the LRIT Coordinator acting on behalf of all SOLAS Contracting Governments.

LRIT information is provided to Contracting Governments to the 1974 SOLAS Convention and Search and rescue services entitled to receive the information, upon request, through a system of National, Regional and Cooperative LRIT Data Centers using the International LRIT Data Exchange.

Each Administration should provide to the LRIT Data Centre it has selected, a list of the ships entitled to fly its flag, which are required to transmit LRIT information, together with other salient details and should update, without undue delay, such lists as and when changes occur. Ships should only transmit the LRIT information to the LRIT Data Centre selected by their Administration.

Additional information concerning LRIT is available at the IMO website via the link in Figure 3021.



Figure 3021. Long-Range Identification and Tracking IMO website.

<http://www.imo.org/en/OurWork/Safety/Navigation/Pages/LRIT.aspx>

The USCG maintains a National Data Center (NDC). The NDC monitors IMO member state ships that are 300 gross tons or greater on international voyages and either bound for a U.S. port or traveling within 1000 nm of the U.S. coast. LRIT complements existing classified and unclassified systems to improve Maritime Domain Awareness.

LRIT is a satellite-based, real-time reporting mechanism that allows unique visibility to position reports of vessels that would otherwise be invisible and potentially a threat to the United States.

The user interface for the US NDC is located at the Navigation Center (NAVCEN) in Alexandria, Virginia. NAVCEN operates the US LRIT interface called the Busi-

ness Help Desk (BHD). BHD operators can perform a multitude of operations with a web-based user interface. Within this web-based application, the BHD watchstanders can view and request vessel status, see vessel information, request vessel positions, and increase and decrease vessel reporting rates.

The US NDC stores all of the positions from any LRIT ship, foreign or domestic, that enters our coastal water polygons. This information is available in real time to the BHD watchstander after performing a basic search for a vessel using the vessel name, IMO number, or MMSI (Maritime Mobile Service Identity) number. Per the LRIT international guidelines, the default ship reporting rate is every six hours. However, functionality is built in to allow end users to request a onetime poll that gives an on-demand current position. Watchstanders can also increase the reporting rate to every 3 hours, 1 hour, 30 minutes, or 15 minutes for a specified period of time.

3022. Commercial Ship Tracking

AIS data is viewable publicly, on the internet, without the need for an AIS receiver. Global AIS transceiver data collected from both satellite and internet-connected shore-based stations are aggregated and made available on the internet through a number of service providers. Data aggregated this way can be viewed on any internet-capable device to provide near global, real-time position data from anywhere in the world. Typical data includes vessel name, details, location, speed and heading on a map, is searchable, has potentially unlimited, global range and the history is archived. Most of this data is free of charge but satellite data and special services such as searching the archives are usually supplied at a cost. The data is a read-only view and the users will not be seen on the AIS network itself.

For an example of a commercial ship tracking website, providing AIS data on merchant vessels to the public, follow the link in Figure 3022a. Figure 3022b depicts a moment in time for ships transiting the Indian Ocean while transmitted AIS data.



Figure 3022a. <http://www.shipfinder.com>

U.S. MARITIME ADVISORY SYSTEM - GLOBAL

3023. Alerts and Advisories

In late 2016, MARAD launched the new U.S. Maritime

Advisory System, which represents the most significant update since 1939 to the U.S. government process for issuing maritime security alerts and advisories. The new

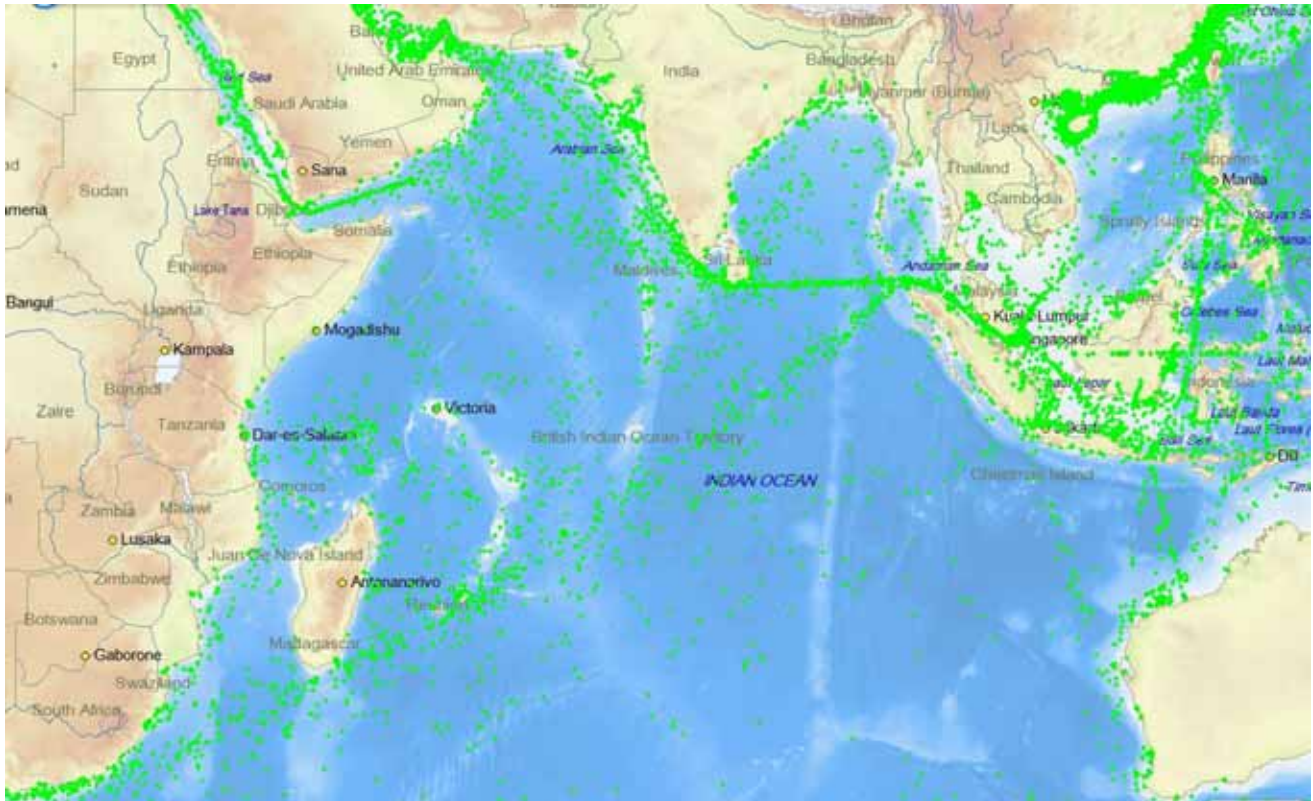

Figure 3022b. Typical AIS ship data for Indian Ocean.

system establishes a single federal process to expeditiously provide maritime threat information to maritime industry stakeholders including vessels at sea. In response to valuable feedback from stakeholders, the **Maritime Advisory System** was developed to streamline, consolidate, and replace maritime threat information previously disseminated in three separate government agency instruments: Special Warnings, MARAD Advisories, and global maritime security related Marine Safety Information Bulletins.

The U.S. Maritime Advisory System includes two types of notifications: A **U.S. Maritime Alert** and a **U.S. Maritime Advisory**. Maritime Alerts quickly provide basic threat information to the maritime industry. When amplifying information is available, a more detailed U.S. Maritime Advisory may be issued on a threat and could include recommendations and identify available resources. U.S. Maritime Alerts and U.S. Maritime Advisories will be broadcast by the National Geospatial-Intelligence Agency, emailed to maritime industry stakeholders, and posted to the Maritime Security Communications with Industry (MSCI) web portal. A link to the web portal is provided in Figure 3023.

The U.S. Maritime Advisory System is a whole-of-government notification mechanism. The Departments of State, Defense, Justice, Transportation, and Homeland Se-

curity, and the intelligence community, supported the development of this new system in coordination with representatives from the U.S. maritime industry through the Alerts, Warnings and Notifications Working Group.

Questions regarding the U.S. Maritime Advisory System may be emailed to MARADSecurity@dot.gov. Additional contact information is available on the MSCI web portal.



Figure 3023. MARAD's Maritime Security Communications with Industry website.

<http://www.marad.dot.gov/MSCI>

CHAPTER 31

REPORTING

NAVIGATIONAL AND OCEANOGRAPHIC REPORTS

3100. Opportunity to Contribute

Mariners at sea, because of their professional skills and location, represent a unique data collection capability unobtainable by any government agency. Provision of high quality navigational and oceanographic information by government agencies requires active participation by mariners in data collection and reporting. Examples of the type of information required are reports of obstructions, shoals or hazards to navigation, unusual sea ice or icebergs, unusual soundings, currents, geophysical phenomena such as magnetic disturbances and subsurface volcanic eruptions, and marine pollution. In addition, detailed reports of harbor conditions and facilities in both busy and out-of-the-way ports and harbors helps charting agencies keep their products current.

The responsibility for collecting hydrographic data by U.S. Naval vessels is detailed in various directives and instructions. Civilian mariners, because they often travel to a wider range of ports, also have an opportunity to contribute substantial amounts of valuable information.

3101. Responsibility for Information

The National Geospatial-Intelligence Agency (NGA), the U.S. Naval Oceanographic Office (NAVOCEANO), the U.S. Coast Guard (USCG) and the National Oceanic and Atmospheric Administration (NOAA) are the primary agencies which receive, process, and disseminate marine information in the U.S.

NGA produces charts, *Notice to Mariners* and other nautical materials for the U.S. military services and for navigators in general for waters outside the U.S.

NAVOCEANO conducts hydrographic and oceanographic surveys of primarily foreign or international waters, and disseminates information to naval forces, government agencies, and civilians.

NOAA conducts hydrographic and oceanographic surveys and provides charts for marine and air navigation in the coastal waters of the United States and its territories.

The U.S. Coast Guard is charged with protecting safety of life and property at sea, maintaining aids to navigation, law enforcement, and improving the quality of the marine

environment. In the execution of these duties, the Coast Guard collects, analyzes, and disseminates navigational and oceanographic data.

Modern technology allows navigators to easily contribute to the body of hydrographic and oceanographic information.

Navigational reports are divided into four categories:

1. Safety Reports
2. Sounding Reports
3. Marine Data Reports
4. Port Information Reports

The seas and coastlines continually change through the actions of man and nature. Improvements realized over the years in the nautical products published by NGA, NOAA, and U.S. Coast Guard have been made possible in part by the reports and constructive criticism of seagoing observers, both naval and merchant marine. NGA and NOAA continue to rely to a great extent on the personal observations of those who have seen the changes and can compare charts and publications with actual conditions. In addition, many ocean areas and a significant portion of the world's coastal waters have never been adequately surveyed for the purpose of producing modern nautical charts.

Information from all sources is evaluated and used in the production and maintenance of NGA, NOAA and USCG charts and publications. Information from surveys, while originally accurate, is subject to continual change. As it is impossible for any hydrographic office to conduct continuous worldwide surveys, U.S. charting authorities depend on reports from mariners to provide a steady flow of valuable information from all parts of the globe.

After careful analysis of a report and comparison with all other data concerning the same area or subject, the organization receiving the information takes appropriate action. If the report is of sufficient urgency to affect the immediate safety of navigation, the information will be broadcast as a SafetyNET or NAVTEX message. Each report is compared with others and contributes in the compilation, construction, or correction of charts and publications. It is only through the constant flow of new information that charts and publications can be kept accurate and up-to-date.

SAFETY REPORTS

3102. Safety Reports

Safety reports are those involving navigational safety which must be reported and disseminated by message. The types of dangers to navigation which will be discussed in this section include ice, floating derelicts, wrecks, shoals, volcanic activity, mines, and other hazards to shipping.

1. Ice—The North American Ice Service (NAIS), a partnership comprised of the International Ice Patrol (IIP), the Canadian Ice Service (CIS), and the U.S. National Ice Center (NIC), provides year-round maritime safety information on iceberg and sea ice conditions in the vicinity of the Grand Banks of Newfoundland and the east coast of Labrador, Canada.

When mariners encounter ice, icebergs, bergy bits, or growlers in the North Atlantic, concentration, thickness, and the position of leading edge should be reported to Commander, International Ice Patrol, New London, CT through a U.S. Coast Guard communications station.

Satellite telephone calls may be made to the International Ice Patrol Operations Center throughout the season at +1 860 271 2626 (toll free 877 423 7287, fax: 860 271 2773, email: iipcomms@uscg.mil).



Figure 3102a. International Ice Patrol.
<http://www.navcen.uscg.gov/IIP>.

When sea ice is observed, the concentration, thickness, and position of the leading edge should be reported. The size, position, and, if observed, rate and direction of drift, along with the local weather and sea surface temperature, should be reported when icebergs, bergy bits, or growlers are encountered.

Ice sightings should also be included in the regular synoptic ship weather report, using the five-figure group following the indicator for ice. This will assure the widest distribution to all interested ships and persons.

For more detailed information on ice reporting consult *Pub No. 117 Radio Navigation Aids*, under Chapter 3 - Radio Navigational Warnings (section 300I: and section 300J: International Ice Warnings). See Figure 3102b for link.



Figure 3102b. NGA- Radio Navigational Aids (*Pub. No. 117*).

https://msi.nga.mil/NGAPortal/MSI.portal?_nfpb=true&_st=&_pageLabel=msi_portal_page_62&pubCode=0009

2. Floating Derelicts—All observed floating and drifting dangers to navigation that could damage the hull or propellers of a vessel at sea should be immediately reported by radio. The report should include a brief description of the danger, the date, time (GMT) and the location as exactly as can be determined (latitude and longitude).

3. Wrecks/Man-Made Obstructions—Information is needed to assure accurate charting of wrecks, man-made obstructions, other objects dangerous to surface and submerged navigation, and repeatable sonar contacts that may be of interest to the U.S. Navy. Man-made obstructions not in use or abandoned are particularly hazardous if unmarked and should be reported immediately. Examples include abandoned wellheads and pipelines, submerged platforms and pilings, and disused oil structures. Ship sinkings, strandings, disposals, or salvage data are also reportable, along with any large amounts of debris, particularly metallic.

Accuracy, especially in position, is vital. Therefore, the date and time of the observation, as well as the method used in establishing the position, and an estimate of the fix accuracy should be included. Reports should also include the depth of water, preferably measured by soundings (in fathoms or meters). If known, the name, tonnage, cargo, and cause of casualty should be provided.

Data concerning wrecks, man-made obstructions, other sunken objects, and any salvage work should be as complete as possible. Additional substantiating information is encouraged.

4. Shoals—When a vessel discovers an uncharted or erroneously charted shoal or an area that is dangerous to navigation, all essential details should be immediately reported to NGA's Maritime Safety Watch via 1-800-362-6289 or navsafety@nga.mil. An uncharted depth of 300 fathoms or less is considered an urgent danger to submarine navigation. Immediately upon receipt of any information reporting dangers to navigation, NGA may issue an appropriate navigation safety warning. The information must appear on published charts as "reported" until sufficient substantiating evidence (i.e. clear and properly annotated echograms and navigation logs, and any other supporting information) is received.

Therefore, originators of shoal reports are requested to verify and forward all substantiating evidence to NGA at the earliest opportunity. Clear and properly annotated echograms and navigation logs are especially important in verifying or disproving shoal reports.

5. Discolored Water—Discolored water is an area of seawater having a color distinctly different from the surrounding water. These observations will normally be of seawater having a color other than the blues and greens typically seen. Variations of the colors – including red, yellow, green and brown, as well as black and white – have been reported. This may be due to dumping (pollution), the existence of shoals, or underwater features such as submerged volcanoes. In near-shore areas, discoloration often results from disturbance of sediment, e.g., disturbances by propeller wash. Discolorations may appear in patches, streaks, or large areas and may be caused by concentrations of inorganic or organic particles or plankton.

In normally deep waters, discolored water can be a strong indication of undersea growth of coral reefs, submerged volcanoes, seamounts, pinnacles and the like. As these features grow in size and dimension, their only indication may be in the form of discolored water on the surface of the sea. Mariners must be prudent in such waters, as they will normally be in areas that are not well surveyed and outside of established routes for oceangoing vessels.

NGA does not maintain a database of such occurrences worldwide. In areas of active submerged volcanoes, discolored water is a common occurrence and all such reports are charted or included in a *Notice to Mariners* correction. Mariners are urged to submit new reports of discolored water to the nearest NAVAREA Coordinator via coast radio stations (for NAVAREA IV and NAVAREA XII) by e-mail to navsafety@nga.mil. Reports can also be submitted via the NGA Maritime Safety Information Web site (<https://msi.nga.mil>).

The legend “discolored water” appears on many NGA charts, particularly those of the Pacific Ocean where underwater volcanic action is known to occur. In such areas, shoal water or discolored water may suddenly appear where only deep water has been historically depicted. Most of these legends remain on the charts from the last century, when very few deep sea soundings were available and less was known about the causes of discolored water. Few reports of discolored water have proved on examination to be caused by shoals. Nonetheless, due to the isolated areas normally in question, mariners should always give prudent respect to what may lie beneath the surface.

Today, such reports can be compared with the accumulated information for the area concerned. A more thorough assessment can be made using imagery if the water conditions and depth (roughly less than 100 feet) allow.

Mariners are therefore encouraged, while having due regard to the safety of their vessels, to approach sightings and areas of discolored water to find whether or not the discoloration is due to shoaling. If there is good reason to

suppose the discoloration is due to shoal water, a report should be made as noted above.

Volcanic Activity. On occasion, volcanic eruptions may occur beneath the surface of the water. These submarine eruptions may occur more frequently and may be more widespread than has been suspected in the past. Sometimes the only evidence of a submarine eruption is a noticeable discoloration of the water, a marked rise in sea surface temperature, or floating pumice (see Figure 3102c). Mariners witnessing submarine volcanic activity have reported trails of steam with a foul sulfurous odor rising from the sea surface and unusual sounds heard through the hull, including shocks resembling a sudden grounding. A subsea volcanic eruption may be accompanied by rumbling and hissing, as hot lava meets the cooler sea.

In some cases, reports of discolored water at the sea surface have been investigated and found to be the result of newly-formed volcanic cones on the sea floor. These cones can grow rapidly and constitute a hazardous shoal in only a few years.



Figure 3102c. USS Bainbridge stopped near a pumice raft in the Red Sea.

Variations in Color. The normal color of the sea in the open ocean in middle and low latitudes is an intense blue or ultramarine. The following variations in appearance occur elsewhere:

- In coastal regions and in the open sea at higher latitudes, where the minute floating animal and vegetable life of the sea (plankton) is in greater abundance, the blue of the sea is modified to shades of green and bluish-green. This discoloration results from a soluble yellow pigment discharged by the plant constituents of the plankton.
- When plankton is found in dense concentrations, the color of the organisms themselves may discolor the sea, giving it a more or less intense brown or red color. The Red Sea, Gulf of California, the region of the Peru Current, South African waters, and the Malabar Coast of India are particularly liable to this variation, seasonally.

- Plankton is sometimes exterminated suddenly by changes in sea conditions, producing a dirty brown or grayish-brown discoloration. This occurs on an unusually extensive scale at times off the Peruvian coast, where the phenomenon is called "Aguaje."
- Larger masses of animate matter, such as fish spawn or floating kelp may produce other kinds of temporary discoloration.
- Mud carried down by rivers produces discoloration which, in the case of the great rivers, may affect a large sea area, such as the Amazon River outfall. Soil or sand particles may be carried out to sea by wind or dust storms, and volcanic dust may fall over a sea area. In all such cases, the water is more or less muddy in appearance.
- Submarine earthquakes may also produce mud or sand discoloration in relatively shallow water, and crude oil has sometimes been seen to gush up. The sea may be extensively covered with floating pumice after a volcanic eruption.
- Isolated shoals in deep water may make the water appear discolored, the color varying with the depth of the water. The play of the sun and cloud on the sea may often produce patches appearing at a distance convincingly like shoal water.

Visibility. The distance at which coral reefs can be seen is dependent upon the observer's height-of-eye, the state of the sea, and the relative position of the sun. When the sea is glassy calm, it is extremely difficult to distinguish the color difference between shallow and deep water. The best conditions for sighting reefs result from a relatively high position, with the sun above 20 degrees elevation and behind the observer, and a sea ruffled by a slight breeze. Under these conditions, with a height of eye of 10-15 meters it is usually possible to sight patches at a depth of less than 6-8 meters from a distance of a few hundred yards.

The use of polarized lenses is strongly recommended, as they make the variations in color of the water stand out more clearly.

If the water is clear, patches with depths of less than 1 meter will appear to be light brown in color; those with depths of 2 meters or more appear to be light green, deepening to a darker green for depths of about 6 meters, and finally to a deep blue for depths over 25 meters. Cloud shadows and shoals of fish may be quite indistinguishable from reefs, but it may be possible to identify them by their movement.

The edges of coral reefs are usually more uniform on their windward or exposed sides and are therefore more easily seen, while the leeward sides are frequently characterized by detached coral heads that are more difficult to see clearly. Water over submerged coral reefs is normally a light blue.

Due to the uncertainty of what discolored water may indicate, mariners are always urged to exercise extreme

caution when in its vicinity. New reports of discolored water should be reported immediately with resulting chart, publication and radio/satellite warnings issued as appropriate.

6. Mines—All mines or objects resembling mines should be considered armed and dangerous. An immediate radio report to NGA should include (if possible):

1. Greenwich Mean Time (UT) and date
2. Position of mine, and how near it was approached
3. Size, shape, color, condition of paint, and presence of marine growth
4. Presence or absence of horns or rings
5. Certainty of identification

3103. Instructions for Safety Report Messages

The International Convention for the Safety of Life at Sea (1974), which is applicable to all U.S. flag ships, states "The master of every ship which meets with dangerous ice, dangerous derelict, or any other direct danger to navigation, or a tropical storm, or encounters subfreezing air temperatures associated with gale force winds causing severe ice accretion on superstructures, or winds of force 10 or above on the Beaufort scale for which no storm warning has been received, is bound to communicate the information by all means at his disposal to ships in the vicinity, and also to the competent authorities at the first point on the coast with which he can communicate."

The transmission of information regarding ice, derelicts, tropical storms, or any other direct danger to navigation is obligatory. The form in which the information is sent is not obligatory. It may be transmitted either in plain language (preferably English) or by any means of *International Code of Signals* (wireless telegraphy section). It should be sent to all vessels in the area and to the first station with which communication can be made, with the request that it be transmitted to the appropriate authority. A vessel will not be charged for radio messages to government authorities reporting dangers to navigation.

Each radio report of a danger to navigation should answer briefly three questions:

1. What? A description of the object or phenomenon
2. Where? Latitude and longitude
3. When? Universal Time (UT) and date

Examples:

Ice

SECURITE. ICE: LARGE BERG SIGHTED DRIFTING SW AT 0.5 KT 4605N, 4410W, AT 0800 GMT, MAY 15.

Derelicts

SECURITE. DERELICT: OBSERVED WOODEN 25 METER DERELICT ALMOST SUBMERGED AT 4406N, 1243W AT 1530 GMT, APRIL 21.

The report should be addressed to one of the following shore authorities as appropriate:

1. U.S. Inland Waters—Commander of the Local Coast Guard District
2. Outside U.S. Waters—NGA NAVSAFETY SPRINGFIELD VA

SOUNDING REPORTS

3104. Sounding Reports

Acquisition of reliable sounding data from all ocean areas of the world is a continuing effort of NGA, NAVOCEANO, and NOAA. There are vast ocean areas where few soundings have ever been acquired. Much of the bathymetric data shown on charts has been compiled from information submitted by mariners. Continued cooperation in observing and submitting sounding data is absolutely necessary to enable the compilation of accurate charts. Compliance with sounding data collection procedures by merchant ships is voluntary, but for U.S. Naval vessels compliance is required under various fleet directives.

3105. Areas Where Soundings are Needed

Prior to a voyage, navigators can determine the importance of recording sounding data by checking the charts for the route. Indications that soundings may be particularly useful are:

1. Old sources listed on source diagram or note
2. Absence of soundings in large areas
3. Presence of soundings, but only along well-defined lines with few or no soundings between tracks
4. Legends such as “Unexplored area”

3106. Fix Accuracy

A realistic goal of open ocean positioning for sounding reports is a few meters using GPS. Depths of 300 fathoms or less should always be reported regardless of the fix accuracy. When such depths are uncharted or erroneously charted, they should be reported by message to NGA NAVSAFETY SPRINGFIELD VA, giving the best available positioning accuracy. Echograms and other supporting information should then be forwarded by mail to NGA: Maritime Safety Office, Mail Stop N64-SFH, National Geospatial-Intelligence Agency, 7500 Geoint Dr., Springfield, VA 22150-7500.

The accuracy goal noted above has been established to enable NGA to create a high quality data base which will

Whenever possible, messages should be transmitted via the nearest government radio station. If it is impractical to use a government station, a commercial station may be used. U.S. government navigational warning messages should invariably be sent through U.S. radio stations, government or commercial, and never through foreign stations. Detailed instructions for reporting via radio are contained in *NGA Pub. 117, Radio Navigational Aids* (see Figure 3102b for link).

support the compilation of accurate nautical charts. It is particularly important that reports contain the navigator’s best estimate of his fix accuracy and that the positioning system being used be identified.

3107. False Shoals

Many poorly identified shoals and banks shown on charts are probably based on encounters with the **Deep Scattering Layer (DSL)**, ambient noise, or, on rare occasions, submarine earthquakes. While each appears real enough at the time of its occurrence, a knowledge of the events that normally accompany these incidents may prevent erroneous data from becoming a charted feature.

The DSL is found in most parts of the world. It consists of a concentration of marine life which descends from near the surface at sunrise to an approximate depth of 200 fathoms during the day. It returns near the surface at sunset. Although at times the DSL may be so concentrated that it will completely mask the bottom, usually the bottom return can be identified at its normal depth at the same time the DSL is being recorded.

Ambient noise or interference from other sources can cause erroneous data. This interference may come from equipment on board the ship, from another transducer being operated close by, or from waterborne noise. Most of these returns can be readily identified on the echo sounder records and should cause no major problems. However, on occasion they may be so strong and consistent as to appear as the true bottom.

Finally, a volcanic disturbance beneath the ship or in the immediate vicinity may give erroneous indications of a shoal. The experience has at times been described as similar to running aground or striking a submerged object. Regardless of whether the feature is an actual shoal or a submarine eruption, the positions, date/time, and other information should be promptly reported to NGA.

3108. Doubtful Hydrographic Data

Navigators are requested to assist in confirming and

charting actual shoals and the removal from the charts of doubtful data which was erroneously reported.

The classification or confidence level assigned to doubtful hydrographic data is indicated by the following standard abbreviations:

<i>Abbreviation</i>	<i>Meaning</i>
Rep (date)	Reported (year)
E.D.	Existence Doubtful
P.A.	Position Approximate
P.D.	Position Doubtful

Many of these reported features are sufficiently deep that a ship can safely navigate across the area. Confirmation of the existence of the feature will result in proper charting. On the other hand, properly collected and annotated sounding reports of the area may enable cartographers to accumulate sufficient evidence to justify the removal of the erroneous sounding from the database.

3109. Preparation of Sounding Reports

The procedures for preparing sounding reports have been designed to minimize the efforts of the shipboard observers, yet provide essential information. Submission of plotted sounding tracks is not required. Annotated echograms and navigation logs are preferred. The procedure for collecting sounding reports is for the ship to operate a recording echo sounder while transiting an area where soundings are desired. Fixes and course changes are recorded in the log, and the event marker is used to note these events on the echogram. Both the log and echogram can then be sent to NGA whenever convenient. From this data, the track will be reconstructed and the soundings keyed to logged times.

The following annotations or information should be clearly written on the echogram to ensure maximum use of the recorded depths:

- 1. Ship's name**—At the beginning and end of each roll or portion of the echogram.
- 2. Date**—Date, noted as local or UT, on each roll or portion of a roll.
- 3. Time**—The echogram should be annotated at the beginning of the sounding run, regularly thereafter (hourly is best), at every scale change, and at all breaks in the echogram record. Accuracy of these time marks is critical for correlation with ship's position.

4. Time Zone—Universal Time (UT) should be used if possible. In the event local zone times are used, annotate echogram whenever clocks are reset and identify zone time in use. It is most important that the echogram and navigation log use the same time basis.

5. Phase or scale changes—If echosounder does not indicate scale setting on echogram automatically, clearly label all depth phase (or depth scale) changes and the exact time they occur. Annotate the upper and lower limits of the echogram if necessary.

Figure 3109a and Figure 3109b illustrate the data necessary to reconstruct a sounding track. If ship operations dictate that only periodic single ping soundings can be obtained, the depths may be recorded in the Remarks column. Cartographers always prefer an annotated echogram over single soundings. The navigation log is vital to the reconstruction of a sounding track. Without the position information from the log, the echogram is virtually useless.

The data received from these reports is digitized and becomes part of the digital bathymetric data library of NGA, from which new charts are compiled. Even in areas where numerous soundings already exist, sounding reports allow valuable cross-checking to verify existing data and more accurately portray the sea floor. Keep in mind that many soundings seen on currently issued charts, and in the sounding database used to make digital charts, were taken when navigation was still largely an art. Soundings accurate to modern GPS standards are helpful to our Naval forces and particularly to the submarine fleet, and are also useful to geologists, geophysicists, and other scientific disciplines.

A report of oceanic soundings should contain:

1. All pertinent information about the ship, sounding system, transducer, etc.
2. A detailed Navigation Log
3. The echo sounding trace, properly annotated

Each page of the report should be clearly marked with the ship's name and date, so that it can be identified if it becomes separated. Mail the report to:

MARITIME SAFETY OFFICE
MAIL STOP N64-SFH
NATIONAL GEOSPATIAL-INTELLIGENCE AGENCY
7500 GEOINT DRIVE
SPRINGFIELD, VA 22150-7500
(or email: navsafety@nga.mil)

MARINE DATA REPORTS

3110. Marine Information Reports

Marine Information Reports are reports of items of

navigational interest such as the following:

1. Discrepancies in published information

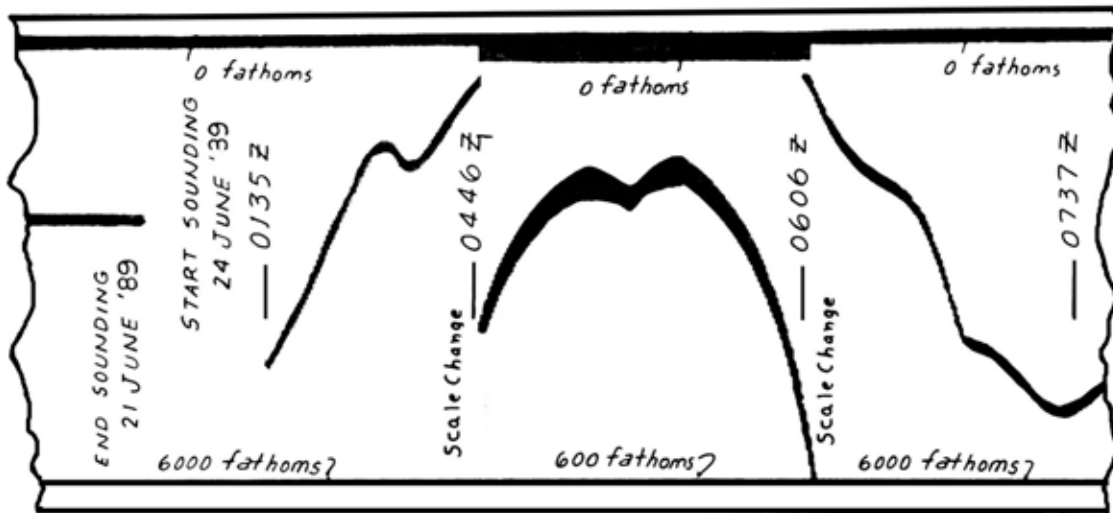

Figure 3109a. Annotated echo sounding record.

NAVIGATION LOG							REMARKS
DATE	TIME (GMT)	LAT.	LONG.	NAV. FIX	COURSE	SPEED	
11/2/83	0221	29°41'N	124°18'E	LORAN	093°	12.3	
	0340				097°	12.3	CHANGE COURSE
	0400	29°40'N	124°35'E	NOON FIX	097°	12.3	
	0728	29°35'N	125°22'E	LORAN	097°	12.3	
	0810				VARIOUS	8.2	REDUCE SPEED - MANEUVERING TO AVOID FISHING BOATS
	0826	29°34'N	125°55'E	LORAN	097°	12.3	RESUME COURSE AND SPEED
	1011	29°32'N	125°56'E	EVENING STARS	097°	12.3	
	1620	29°23'N	127°22'E	LORAN	102°	12.4	CHANGE COURSE
	2230	29°06.2'N	128°48.5'E	RADAR STAR	102°	12.5	
	2305				102°	10.1	REDUCE SPEED

Figure 3109b. Typical navigation log for hydrographic reporting.

2. Changes in aids to navigation
3. Electronic navigation reports
4. Satellite navigation reports
5. Radar navigation reports
6. Magnetic disturbances

Any information believed to be useful to charting authorities or other mariners should be reported. Depending on the type of report, certain information is absolutely critical for a correct evaluation. The following general suggestions are offered to assist in reporting information that will be of maximum value:

1. The geographical position included in the report may be used to correct charts. Accordingly, it should be fixed by the most exact method available, and more than one if possible.
2. If geographical coordinates are used to report position, they should be as exact as circumstances permit. Reference should be made to paper charts by number, edition number, and edition date.
3. The report should state the method used to fix the position and an estimate of fix accuracy.
4. When reporting a position within sight of charted objects, the position may be expressed as bearings and ranges from them. Bearings should preferably be reported as true and expressed in degrees.
5. Always report the limiting bearings from the ship toward the light when describing the sectors in which a light is either visible or obscured. Although this is just the reverse of the form used to locate objects, it is the standard method used on NGA nautical charts and in light lists.
6. A report prepared by one person should, if possible,

be checked by another.

In most cases marine information can be adequately reported on one of the various forms provided or posted on the internet by NGA or NOAA. It may be more convenient to annotate information (such as uncharted or erroneously charted shoals, buildings, or geological features) directly on the affected chart and send it to NGA. Appropriate supporting information should also be provided. NGA forwards reports as necessary to NOAA, NAVOCEANO, or U.S. Coast Guard.

Reports by letter or e-mail are just as acceptable as those prepared on regular forms. A letter report will often allow more flexibility in reporting details, conclusions, or recommendations concerning the observation. When reporting on the regular forms, use additional sheets if necessary to complete the details of an observation.

Reports are required concerning any errors in information published on nautical charts or in nautical publications. The reports should be as accurate and complete as possible. This will result in corrections to the information, including the issuance of a *Notice to Mariners* when appropriate.

Report all changes, defects, establishment or discontinuance of navigational aids and the source of the information. Check your report against the *List of Lights, Pub. 117, Radio Navigational Aids*, and the largest scale chart of the area. If a new, uncharted light has been established, report the light and its characteristics in a format similar to that carried in light lists. For changes and defects, report only elements that differ with light lists. If it is a lighted aid, identify by number. Defective aids to navigation in U.S. waters should be reported immediately to the Commander of the local Coast Guard District.

A Marine Information Report and Suggestion Sheet template, along with instructions, is found in each weekly *US Notice to Mariners*.

3111. Electronic Navigation System Reports

Reports on electronic navigation anomalies or any unusual reception while using the electronic navigation systems are desired.

Information should include:

1. Type of system
2. Type of antenna
3. Nature and description of the reception
4. Date and time
5. Position of ship
6. Manufacturer and model of receiver

3112. Radar Navigation Reports

Reports of any unusual reception or anomalous propagation by radar systems caused by atmospheric conditions are especially desirable. Comments concerning the use of radar in piloting, with the locations and description of good radar targets, are particularly needed. Reports should include:

1. Type of radar, frequency, antenna height and type.
2. Manufacturer and model of the radar
3. Date, time and duration of observed anomaly
4. Position
5. Weather and sea conditions

Radar reception problems caused by atmospheric parameters are contained in four groups. In addition to the previously listed data, reports should include the following specific data for each group:

1. Unexplained echoes—Description of echo, apparent velocity and direction relative to the observer, and range
2. Unusual clutter—Extent and Sector
3. Extended detection ranges—Surface or airborne target, and whether point or distributed target, such as a coastline or landmass
4. Reduced detection ranges—Surface or airborne target, and whether point or distributed target, such as a coastline or landmass

3113. Magnetic Disturbances

Magnetic anomalies, the result of a variety of causes, exist in many parts of the world. NGA maintains a record of such magnetic disturbances and whenever possible attempts to find an explanation. A better understanding of this phenomenon can result in more detailed charts which will be of greater value to the mariner.

The report of a magnetic disturbance should be as specific as possible. For instance: "Compass quickly swung 190° to 170°, remained offset for approximately 3 minutes and slowly returned." Include position, ship's course, speed, date, and time.

Whenever the readings of the standard magnetic compass are unusual, an azimuth check should be made as soon as possible and this information included in a report to NGA.

PORT INFORMATION REPORTS

3114. Importance of Port Information Reports

Port Information Reports provide essential

information obtained during port visits which can be used to update and improve coastal, approach, and harbor charts as well as nautical publications including *Sailing*

Directions, Coast Pilots, and Fleet Guides. Engineering drawings, hydrographic surveys and port plans showing new construction affecting charts and publications are especially valuable.

Items involving navigation safety should be reported by message or e-mail. Items which are not of immediate urgency, as well as additional supporting information may be submitted by the *Sailing Directions* Information and Suggestion Sheet found in the front of each volume of *Sailing Directions*, or the *Notice to Mariners* Marine Information Report and Suggestion Sheet found in the back of each *Notice to Mariners*. Reports by letter are completely acceptable and may permit more reporting flexibility.

Reports regarding U.S. waters and the U.S. Coast Pilot may be submitted through the NOAA Nautical Inquiry and Comment System link provided in Figure 3114.



Figure 3114. Link to NOAA Nautical Inquiry and Comment System. <https://ocsddata.ncd.noaa.gov/idrs/inquiry.aspx>

In some cases it may be more convenient and more effective to annotate information directly on a chart and mail it to NGA. As an example, new construction, such as new port facilities, pier or breakwater modifications, etc., may be drawn on a chart in cases where a written report would be inadequate.

Specific reporting requirements exist for U.S. Navy ships visiting foreign ports. These reports are primarily intended to provide information for use in updating the Navy Port Directories. A copy of the navigation information resulting from port visits should be provided directly to NGA by including NGA Maritime Safety Office, Springfield, VA as an INFO addressee on messages containing hydrographic information.

3115. What to Report

Coastal features and landmarks are almost constantly changing. What may at one time have been a major landmark may now be obscured by new construction, destroyed, or changed by the elements. *Sailing Directions (Enroute)* and *Coast Pilots* utilize a large number of photographs and line sketches. Digital images, particularly a series of overlapping views showing the coastline, landmarks, and harbor entrances are very useful.

When taking images for inclusion in NGA nautical publication, please use the highest resolution possible and send the image(s) with description of the feature and the exact Lat./Long. where the image was taken to:

navsafety@nga.mil or to NOAA, for U.S. waters, through the link found in Figure 3114. There is also a desire for video of actual approaches to entrances to ports and harbors. See additional discussion on this topic below under "Images."

The following questions are suggested as a guide in preparing reports on coastal areas that are not included or that differ from the *Sailing Directions* and *Coast Pilots*.

Approach

1. What is the first landfall sighted?
2. Describe the value of soundings, GPS, radar and other positioning systems in making a landfall and approaching the coast. Are depths, curves, and coastal dangers accurately charted?
3. Are prominent points, headlands, landmarks, and aids to navigation adequately described in *Sailing Directions* and *Coast Pilots*? Are they accurately charted?
4. Do land hazes, fog or local showers often obscure the prominent features of the coast?
5. Do discolored water and debris extend offshore? How far? Were tidal currents or rips experienced along the coasts or in approaches to rivers or bays?
6. Are any features of special value as radar targets?

Tides and Currents

1. Are the published tide and current tables accurate?
2. Does the tide have any special effect such as river bore? Is there a local phenomenon, such as double high or low water or interrupted rise and fall?
3. Was any special information on tides obtained from local sources?
4. What is the set and drift of tidal currents along coasts, around headlands, among islands, in coastal indentations?
5. Are tidal currents reversing or rotary? If rotary, do they rotate in a clockwise or counterclockwise direction?
6. Do subsurface currents affect the maneuvering of surface craft? If so, describe.
7. Are there any countercurrents, eddies, overfalls, or tide rips in the area? If so, where?

River and Harbor Entrances

1. What is the depth of water over the bar, and is it subject to change? Was a particular stage of tide necessary to permit crossing the bar?
2. What is the least depth in the channel leading from sea to berth?
3. If the channel is dredged, when and to what depth and width? Is the channel subject to silting?
4. What is the maximum draft, length and width of a vessel that can enter port?
5. If soundings were taken, what was the stage of tide? If the depth information was received from other sources, what were they?

6. What was the date and time of water depth observations?

Hills, Mountains, and Peaks

1. Are hills and mountains conical, flat-topped, or of any particular shape?
2. At what range are they visible in clear weather?
3. Are they snowcapped throughout the year?
4. Are they cloud covered at any particular time?
5. Are the summits and peaks adequately charted? Can accurate distances and/or bearings be obtained by sextant, pelorus, or radar?
6. What is the quality of the radar return?

Pilotage

1. Where is the signal station located?
2. Where does the pilot board the vessel? Are special arrangements necessary before a pilot boards?
3. Is pilotage compulsory? Is it advisable?
4. Will a pilot direct a ship in at night, during foul weather, or during periods of low visibility?
5. Where does the pilot boat usually lie?
6. Does the pilot boat change station during foul weather?
7. Describe the radiotelephone communication facilities available at the pilot station or pilot boat. What is the call sign, frequency, and the language spoken?

General

1. What cautionary advice, additional data, and information on outstanding features should be given to a mariner entering the area for the first time?
2. At any time did a question or need for clarification arise while using NGA, NOAA, or U.S. Coast Guard products?
3. Were charted land contours useful while navigating using radar? Indicate the charts and their edition numbers.
4. Would it be useful to have radar targets or topographic features that aid in identification or position plotting described or portrayed in the *Sailing Directions* and *Coast Pilots*?

Images

Images of features or aids to navigation described in nautical publication are desirable. These may include annotations by the photographer. Additional information (or metadata) should accompany images sent to NGA, to include the camera position by bearing and distance from a charted object (or feature) if possible, name of the vessel, the date, time of exposure, height of eye (camera) and stage of tide. All features of navigational value should be clearly and accurately identified. Bearings and distances (from the vessel) of uncharted features identified in the image should

be included. Images may be sent electronically via e-mail or transferred to CD/DVD's and sent via snail mail if file sizes warrant.

Port Regulations and Restrictions

Sailing Directions (Planning Guides) are concerned with pratique, pilotage, signals, pertinent regulations, warning areas, and navigational aids. The following questions are suggested as a guide to the requested data.

1. Is this a port of entry for overseas vessels?
2. If not a port of entry, where must a vessel go for customs entry and pratique?
3. Where do customs, immigration, and health officials board?
4. What are the normal working hours of officials?
5. Will the officials board vessels after working hours? Are there overtime charges for after-hour services?
6. If the officials board a vessel underway, do they remain on board until the vessel is berthed?
7. Were there delays? If so, give details.
8. Were there any restrictions placed on the vessel?
9. Was a copy of the Port Regulations received from the local officials?
10. What verbal instructions were received from the local officials?
11. What preparations prior to arrival would expedite formalities?
12. Are there any unwritten requirements peculiar to the port?
13. What are the speed regulations?
14. What are the dangerous cargo regulations?
15. What are the flammable cargo and fueling regulations?
16. Are there special restrictions on blowing tubes, pumping bilges, oil pollution, fire warps, etc.?
17. Are the restricted and anchorage areas correctly shown on charts, and described in the *Sailing Directions* and *Coast Pilots*?
18. What is the reason for the restricted areas: gunnery, aircraft operating, waste disposal, etc.?
19. Are there specific hours of restrictions, or are local blanket notices issued?
20. Is it permissible to pass through, but not anchor in, restricted areas?
21. Do fishing boats, stakes, nets, etc., restrict navigation?
22. What are the heights of overhead cables, bridges, and pipelines?
23. What are the locations of submarine cables, their landing points, and markers?
24. Are there ferry crossings or other areas of heavy local traffic?
25. What is the maximum draft, length, and breadth of a vessel that can enter?

Port Installations

Much of the port information which appears in the *Sailing Directions* and *Coast Pilots* is derived from visit reports and port brochures submitted by mariners. Comments and recommendations on entering ports are needed so that corrections to these publications can be made.

If extra copies of local port plans, diagrams, regulations, brochures, photographs, etc. can be obtained, send them to NGA or to NOAA for U.S. waters through the NOAA Nautical Inquiry and Comments System via the link found in Figure 3114. It is not essential that port information be printed in English. Local pilots, customs officials, company agents, etc., are usually good information sources.

The following list may be used as a check-off list when submitting a letter report:

General

1. Name of the port
2. Date of observation and report
3. Name and type of vessel
4. Gross tonnage
5. Length (overall)
6. Breadth (extreme)
7. Draft (fore and aft)
8. Name of captain and observer
9. U.S. mailing address for acknowledgment

Tugs and Locks

1. Are tugs available or obligatory? What is their power?
2. If there are locks, what is the maximum size and draft of a vessel that can be locked through?

Cargo Handling Facilities

1. What are the capacities of the largest stationary, mobile, and floating cranes available? How was this information obtained?
2. What are the capacities, types, and number of lighters and barges available?
3. Is special cargo handling equipment available (e.g. grain elevators, coal and ore loaders, fruit or sugar conveyors, etc.)?
4. If cargo is handled from anchorage, what methods are used? Where is the cargo loaded? Are storage facilities available there?

Supplies

1. Are fuel oils, diesel oils, and lubricating oils available? If so, in what quantity?

Berths

1. What are the dimensions of the pier, wharf, or basin used?
2. What are the depths alongside? How were they obtained?
3. Describe berth or berths for working containers or roll-on/roll-off cargo.
4. Does the port have berth for working deep draft tankers? If so, describe.
5. Are both dry and refrigerated storage available?
6. Are any unusual methods used when docking? Are special precautions necessary at berth?

Medical, Consular, and Other Services

1. Is there a hospital or the services of a doctor and dentist available?
2. Is there a United States consulate? Where is it located? If none, where is the nearest?

Anchorage

1. What are the limits of the anchorage areas?
2. In what areas is anchoring prohibited?
3. What is the depth, character of the bottom, types of holding ground, and swinging room available?
4. What are the effects of weather, sea, swell, tides, and currents on the anchorages?
5. Where is the special quarantine anchorage?
6. Are there any unusual anchoring restrictions?

Repairs and Salvage

1. What are the capacities of drydocks and marine railways, if available?
2. What repair facilities are available? Are there repair facilities for electrical and electronic equipment?
3. Are divers and diving gear available?
4. Are there salvage tugs available? What is the size and operating radius?
5. Are any special services (e.g. compass compensation or degaussing) available?

MISCELLANEOUS HYDROGRAPHIC REPORTS

3116. Ocean Current Reports

The set and drift of ocean currents are of great concern to the navigator. Only with the correct current information can the shortest and most efficient voyages be planned. As with all forces of nature, most currents vary considerably

with time at a given location.

The general surface currents along the principal trade routes of the world are well known. However, in other less traveled areas the current has not been well defined because of a lack of information. Detailed current reports from these areas are especially valuable.

An urgent need exists for more inshore current reports along all coasts of the world because data is scarce. Furthermore, information from deep draft ships is needed as this type of vessel is significantly influenced by the deeper layer of surface currents.

The CURRENT REPORT form, NAVOCEANO 3141/6, is designed to facilitate passing information to NAVOCEANO so that all mariners may benefit. The form is self-explanatory and can be used for ocean or coastal current information. Reports by the navigator will contribute significantly to accurate current information for nautical charts, current atlases, *Pilot Charts*, *Sailing Directions* and other special charts and publications.

3117. Route Reports

Route Reports enable NGA, through its *Sailing Directions (Planning Guides)*, to make recommendations for ocean passages based upon the actual experience of mariners. Of particular importance are reports of routes

used by very large ships and from any ship in regions where, from experience and familiarity with local conditions, mariners have devised routes that differ from the "preferred track." In addition, because of the many and varied local conditions which must be taken into account, coastal route information is urgently needed for updating both *Sailing Directions* and *Coast Pilots*.

A Route Report should include a comprehensive summary of the voyage with reference to currents, dangers, weather, and the draft of the vessel. If possible, each report should answer the following questions and should include any other data that may be considered pertinent to the particular route. All information should be given in sufficient detail to assure accurate conclusions and appropriate recommendations. Some questions to be answered are:

1. Why was the route selected?
2. Were anticipated conditions met during the voyage?

AMVER

3118. The Automated Mutual-Assistance Vessel Rescue System (AMVER)

The purpose of ship reporting systems is to monitor vessels' positions at sea so that a response to any high-seas emergency can be coordinated among those nearest and best able to help. It is important that complete information be made available to search and rescue (SAR) coordinators immediately so that the right type of assistance can be sent to the scene with the least possible delay.



Figure 3118. AMVER burgee.

For example, a medical emergency at sea might require a doctor; a ship reporting system can find the nearest vessel with a doctor aboard. A sinking craft might require a vessel to rescue the crew, and perhaps another to provide a lee. A ship reporting system allows SAR coordinators to quickly assemble the required assets to complete the rescue.

The International Convention for the Safety of Life at

Sea (SOLAS) obligates the master of any vessel who becomes aware of a distress incident to proceed to the emergency and assist until other aid is at hand or until released by the distressed vessel. Other international treaties and conventions impose the same requirement.

By maintaining a database of information as to the particulars of each participating vessel, and monitoring their positions as their voyages proceed, the AMVER coordinator can quickly ascertain which vessels are closest and best able to respond to any maritime distress incident. They can also release vessels that might feel obligated to respond from their legal obligation to do so, allowing them to proceed on their way without incurring liability for not responding. International agreements ensure that no costs are incurred by a participating vessel.

Several ship reporting systems are in operation throughout the world. The particulars of each system are given in publications of the International Maritime Organization (IMO). Masters of vessels making offshore passages are requested to always participate these systems when in the areas covered by them. The only worldwide system in operation is the U.S. Coast Guard's AMVER system.

AMVER is an international maritime mutual assistance program that coordinates search and rescue efforts around the world. It is voluntary, free of charge, and endorsed by the International Maritime Organization (IMO). Merchant ships of all nations are encouraged to file a sailing plan, periodic position reports, and a final report at the end of each voyage, to the AMVER Center located in the U.S. Coast Guard Operations Systems Center in Martinsburg, WV. Reports can be sent via e-mail, Inmarsat-C, AMVER/SEAS "compressed message" format, Sat-C format, HF radiotelex, HF radio or telefax message. Most reports can be sent at little or no cost to the ship.

Data from these reports is protected as “commercial proprietary” business information, and is released by U.S. Coast Guard only to recognized national SAR authorities and only for the purposes of SAR in an actual distress. Information concerning the predicted location and SAR characteristics of each vessel is available upon request to recognized SAR agencies of any nation or to vessels needing assistance. Predicted locations are disclosed only for reasons related to marine safety.

The AMVER computer uses a dead reckoning system to predict the positions of participating ships at any time during their voyage. Benefits to participating vessels and companies include:

- Improved chances of timely assistance in an emergency.
- Reduced number of calls for ships not favorably located.
- Reduced lost time for vessels responding.
- Added safety for crews in the event of an overdue vessel.

AMVER participants can also act as the eyes and ears of SAR authorities to verify the authenticity of reports, reducing the strain on SAR personnel and facilities. AMVER is designed to compliment computer and communications technologies, including the Global Maritime Distress Safety System (GMDSS) that provides distress alerting and GPS positioning systems. These technologies can reduce or entirely eliminate the search aspect of search and rescue (since the precise location of the distress can be known), allowing SAR authorities to concentrate immediately on the response.

The AMVER Sailing Plan provides information on the port of departure, destination, course, speed, navigational method, waypoints, communications capabilities, and the presence of onboard medical personnel. The database contains information on the ship’s official name and registry, call sign, type of ship, tonnage, propulsion, maximum speed, and ownership. Changes in any of this data should be reported to AMVER at the earliest opportunity.

AMVER participants bound for U.S. ports enjoy an additional benefit: AMVER messages which include the necessary information are considered to meet the requirements of 33 CFR 161 (Notice of Arrival).

3119. The AMVER Communications Network

The following methods are recommended for ships to transmit information to AMVER:

1. **Electronic mail** (e-mail) via the Internet: The AMVER internet e-mail address is amvermsg@amver.com. If a ship already has an inexpensive means of sending e-mail to an internet address, this is the preferred method. The land-based portion of an e-mail message is free, but there may be a charge for any ship-to-shore portion. Reports should be sent in the body of the message, not as attachments.

2. **AMVER/SEAS Compressed Message via Inmarsat-C via Telenor.** AMVER address: National Oceanic and Atmospheric Administration (NOAA) Phone number entered in the ADDRESSBOOK. [For information, please see the instruction

sheet for your brand of International Mobile Satellite Organization (INMARSAT)-C transceiver.]

- Ships must be equipped with INMARSAT Standard C transceiver with floppy drive and capability to transmit a binary file [ship’s GMDSS INMARSAT-C transceiver can be used].
- Ships must have an IBM-compatible computer (which is not part of the ship’s GMDSS system), and it must meet the following minimum requirements:
 - hard drive
 - 286 MHz or better processor
 - VGA graphics
 - an interface between the computer and the INMARSAT transceiver
 - AMVER/SEAS software - free via NOAA at https://www.aoml.noaa.gov/phod/goos/seas/amver_software.php

Ships that meet the system requirements may send combined AMVER/Weather observation messages *Free of Charge* via Telenor Land Earth Stations at:

001 Atlantic Ocean Region-West (AOR-W)-Southbury
 101 Atlantic Ocean Region East (AOR-E)-Southbury
 201 Pacific Ocean Region (POR)-Santa Paula
 321 Indian Ocean Region (IOR)-Assaguel

3. **HF Radiotelex Service** - As March 31, 2012 the Coast Guard discontinued all ship/Shore/ship SITOR services except for marine information broadcasts.

4. **HF Radio** at no cost via Coast Guard contractual agreements with the following companies:

- Mobile Marine Radio (WLO)
- Mobile (WCL)
- Marina Del Rey (KNN)
- Seattle (KLB)

5. **Telex:** AMVER Address (0) (230) 127594 AMVERNYK.

AMVER reports may be filed via telex using either satellite (code 43) or HF radio. Ships must pay the tariffs for satellite communications. Telex is a preferred method when less costly methods are not available.

6. **Telefax:** Telefacsimile (telefax) phone number to the USCG Operations Systems Center (OSC) in Martinsburg, West Virginia: (01) (304) 264-2505.

In the event other communication media are unavailable or inaccessible, AMVER reports may be faxed directly to the AMVER computer center. However, this is the least desirable method of communication since it involves manual input of information to the computer verses electronic processing. Please Note: Do not fax reports to the AMVER Maritime Relations Office (AMR) in New York since it is not staffed 24 hours a day, seven days a week, and relay and processing of reports is delayed pending normal Monday-Friday business hours.

3120. AMVER Participation

Instructions guiding participation in the AMVER System are available online from the **AMVER website**. The AMVER User's Manual is published in Chinese, Dutch, and English. This manual is available online (at no cost) via the website and link provided in Figure 3120.



Figure 3120. AMVER Ship Reporting System Manual.
<http://www.amver.com>

To enroll in AMVER, a ship must first complete a SAR Questionnaire (SAR-Q). Participation involves filing four types of reports:

1. Sailing Plan
2. Position Report
3. Deviation Report
4. Final Report

The **Sailing Plan** is sent before leaving port, and indicates the departure time and date, destination, route and waypoints, speed, and navigational method.

The **Position Report** is sent after the first 24 hours to confirm departure as planned and conformance with the reported Sailing Plan. An additional report is requested every 48 hours to verify the DR plot being kept in the AMVER computer.

A **Deviation Report** should be sent whenever a change of route is made, or a change to course or speed due to weather, heavy seas, casualty, or any other action that would render the computerized DR inaccurate.

A **Final Report** should be sent at the destination port. The system then removes the vessel from the DR plot and logs the total time the ship was participating.

Vessels that travel certain routes on a recurring basis may be automatically tracked for successive voyages as long as delays in regular departures are reported. The system may also be used to track vessels sailing under special circumstances such as tall ships, large ocean tows, research vessel operations, factory fishing vessels, etc. At any given time nearly 3,000 vessels worldwide are being plotted by AMVER, and the number of persons rescued as a direct result of AMVER operations is in the hundreds each year.

3121. SAR Manuals

SAR operational procedures are contained in the International Aeronautical and Maritime Search and Rescue (IAMSAR) Manual, a three volume set published jointly by

the IMO and the ICAO. Volume III of this manual is required aboard SOLAS vessels.

The **United States National Search and Rescue Supplement (NSS)** to the IAMSAR manual provides guidance to all federal forces, military and civilian, that support civil search and rescue operations. The NSS is available online via the link from provided in Figure 3121.



Figure 3121. U.S. National Search and Rescue Supplement to the IAMSAR.

https://www.uscg.mil/hq/cg5/cg534/manuals/Natl_SAR_supp.pdf

3122. AMVER Reporting Requirements

The U.S. Maritime Administration (MARAD) regulations state that certain U.S. flag vessels and foreign flag "War Risk" vessels must report and regularly update their voyages to the AMVER Center. This reporting is required of the following: (a) U.S. flag vessels of 1,000 tons or greater, operating in foreign commerce; (b) foreign flag vessels of 1,000 gross tons or greater, for which an Interim War Risk Insurance Binder has been issued under the provisions of Title XII, Merchant Marine Act, 1936.

3123. The Surface Picture (SURPIC)

When a maritime distress is reported to SAR authorities, the AMVER computer is queried to produce a **Surface Picture (SURPIC)** in the vicinity of the distress. Several different types of SURPIC are available, and they can be generated for any specified time. The SURPIC output is a text file containing the names of all vessels meeting the criteria requested, plus a subset of the information recorded in the database about each vessel. See Figure 3123. A graphic display can be brought up for the **Rescue Coordination Center (RCC)** to use, and the data can be sent immediately to other SAR authorities worldwide. The information provided by the SURPIC includes the position of all vessels in the requested area, their courses, speeds, estimated time to reach the scene of the distress, and the amount of deviation from its course required for each vessel if it were to divert. RCC staff can then direct the best-placed, best-equipped vessel to respond.

Four types of SURPIC can be generated:

A **Radius SURPIC** may be requested for any radius from 50 to 500 miles. A sample request might read:

“REQUEST 062100Z RADIUS SURPIC OF DOCTOR-SHIPS WITHIN 800 MILES OF 43.6N 030.2W FOR MEDICAL EVALUATION M/V SEVEN SEAS.”

The **Rectangular SURPIC** is obtained by specifying the date, time, and two latitudes and two longitudes. As with the Radius SURPIC, the controller can limit the types of ships to be listed. There is no maximum or minimum size limitation on a Rectangular SURPIC.

A sample Area SURPIC request is as follows:

<u>Name</u>	<u>Call sign</u>	<u>Position</u>	<u>Course</u>	<u>Speed</u>	<u>SAR data</u>	<u>Destination and ETA</u>
CHILE MARU CPA 258 DEG. 012 MI. 032000Z	JAYU	26.2 N 179.9E	C294	12.5K	H 1 6 R T X Z	KOBE 11
WILYAMA CPA 152 DEG. 092 MI. 032000Z	LKBD	24.8N 179.1W	C106	14.0K	H X R T V X Z	BALBOA 21
PRES CLEVELAND CPA 265 WILL PASS WITHIN 10 MI. 040430Z	WITM	25.5N 177.0W	C284	19.3K	H 2 4 R D T X Z S	YKHAMA 08
AENEAS CPA 265 DEG. 175 MI. 03200Z	GMRT	25.9N 176.9E	C285	16.0K	H 8 R N V X Z	YKHAMA 10

Figure 3123. Radius SURPIC as received by a rescue center.

A Snapshot Trackline SURPIC request might look like:

“REQUEST 310100Z GREAT CIRCLE TRACKLINE SURPIC OF ALL SHIPS WITHIN 50 MILES OF A LINE FROM 20.1N 150.2W TO 21.5N 158.0W FOR AIRCRAFT PRECAUTION.”

A **Moving Point SURPIC** is defined by the starting and ending points of a vessel’s trackline, the estimated departure time of the vessel, and the varying time of the SURPIC. This SURPIC is useful when a vessel is overdue at her destination. If the vessel’s trackline can be accurately estimated, a SURPIC can be generated for increments of time along the trackline, and a list can be generated of ships that might have sighted the missing ship.

3124. Uses of AMVER Information

After evaluating the circumstances of a reported distress, The RCC can select the best available vessel to divert to the scene. In many cases a participating ship will be asked only to change course for a few hours or take a slightly different route to their destination, in order to provide a lookout in a certain area. RCC coordinators strive to use participating ships efficiently, and release them as soon as possible.

“REQUEST 151300Z AREA SURPIC OF WESTBOUND SHIPS FROM 43N TO 31N LATITUDE AND FROM 130W TO 150W LONGITUDE FOR SHIP DISTRESS M/V EVENING SUN LOCATION 37N, 140W.”

The **Snapshot** or **Trackline SURPIC** is obtained by specifying the date and time, two points (P1 and P2), whether the trackline should be rhumb line or great circle, what the half-width (D) coverage should be (in nautical miles), and whether all ships are desired or only those meeting certain parameters (e.g. doctor on board).

An example of the use of a Radius SURPIC is depicted in Figure 3124. In this situation rescue authorities believe that a ship in distress, or her survivors, might be found in the rectangular area. The RCC requests a SURPIC of all eastbound ships within 100 miles of a position well west of the rectangular area. With this list, the RCC staff prepares a modified route for each of four ships which will comprise a “search team” to cover the entire area, while adding only a few miles to each ship’s route. Messages to each ship specify the exact route to follow and what to look for enroute.

Each ship contacted may be asked to sail a rhumb line between two specified points, one at the beginning of the search area and one at the end. By carefully assigning ships to areas of needed coverage, very little time need be lost from the sailing schedule of each cooperating ship. Those ships joining the search would report their positions every few hours to the RCC, together with weather data and any significant sightings. In order to achieve saturation coverage, a westbound SURPIC at the eastern end of the search area would also be used.

The Trackline SURPIC is most commonly used as a precautionary measure for aircraft. Occasionally a plane loses one or more of its engines. A Trackline SURPIC, provided from the point of difficulty to the destination, provides the pilot with the added assurance of 1) knowing positions of vessels beneath him/her and 2) that these ships

were alerted. While the chance of an airliner experiencing such an emergency is extremely remote, SURPICs have

been used successfully to save the lives of pilots of general aviation aircraft on oceanic flights.

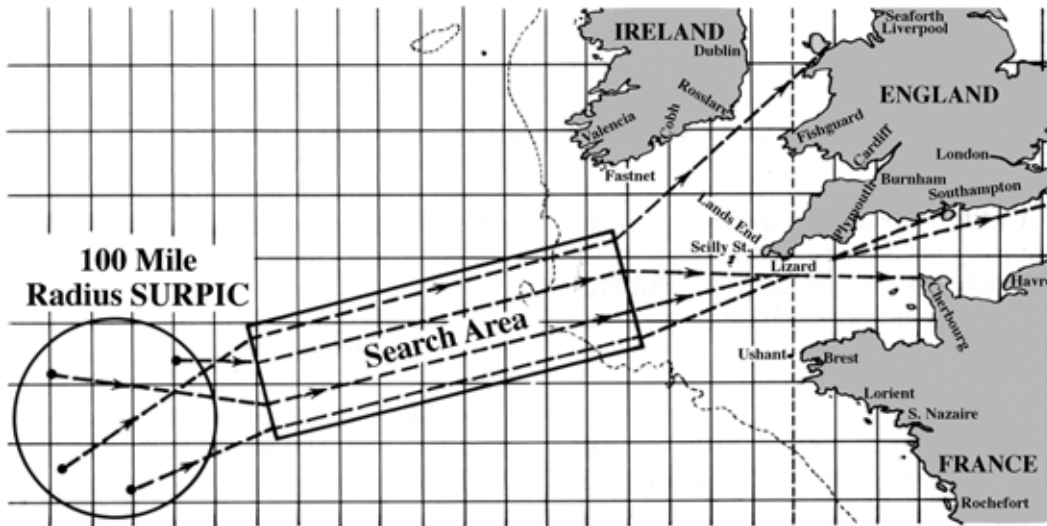

Figure 3124. Example of the use of a radius SURPIC to locate ships to search a rectangular area.

CHAPTER 32

ICE NAVIGATION

INTRODUCTION

3200. Ice and the Navigator

Sea ice has posed a problem to the navigator since antiquity. During a voyage from the Mediterranean to England and Norway sometime between 350 B.C. and 300 B.C., Pytheas of Massalia sighted a strange substance which he described as “neither land nor air nor water” floating upon and covering the northern sea over which the summer sun barely set. Pytheas named this lonely region Thule, hence Ultima Thule (farthest north or land’s end). Thus began over 20 centuries of polar exploration.

Ice is of direct concern to the navigator because it restricts and sometimes controls vessel movements; it affects dead reckoning by forcing frequent changes of course and speed; it affects piloting by altering the appearance or obliterating the features of landmarks; it hinders the establishment and maintenance of aids to navigation; it affects the use of electronic equipment by affecting propagation of radio waves; it produces changes in surface features and in radar returns from these features; it affects celestial navigation by altering the refraction and obscuring the horizon and celestial bodies either directly or by the weather it influences, and it affects charts by introducing several plotting problems.

Because of this direct concern with ice, the prospective polar navigators must acquaint themselves with its nature and extent in the area they expect to navigate. In addition to this volume, books, articles, and reports of previous polar operations and expeditions will help acquaint the polar navigator with the unique conditions at the ends of the Earth.

3201. Formation of Sea Ice

As it cools, water contracts until the temperature of maximum density is reached. Further cooling results in expansion. The maximum density of fresh water occurs at a temperature of 4.0°C, and freezing takes place at 0°C. The inclusion of salt lowers both the temperature of maximum density and, to a lesser extent, that of freezing. These relationships are shown in Figure 3201. The two lines meet at a salinity of 24.7 parts per thousand, at which maximum density occurs at the freezing temperature of -1.3°C. At this and greater salinities, the temperature of maximum density of sea water is coincident with the freezing point temperature, i.e., the density increases as the temperature gets colder. At a salinity of 35 parts per thousand, the approxi-

mate average for the oceans, the freezing point is -1.88°C.

As the density of surface seawater increases with decreasing temperature, convective density-driven currents are induced bringing warmer, less dense water to the surface. If the polar seas consisted of water with constant salinity, the entire water column would have to be cooled to the freezing point in this manner before ice would begin to form. This is not the case, however, in the polar regions where the vertical salinity distribution is such that the surface waters are underlain at shallow depth by waters of higher salinity. In this instance density currents form a shallow mixed layer which subsequently cannot mix with the deep layer of warmer but saltier water. Ice will then begin forming at the water surface when density currents cease and the surface water reaches its freezing point. In shoal water, however, the mixing process can be sufficient to extend the freezing temperature from the surface to the bottom. Ice crystals can, therefore, form at any depth in this case. Because of their lower density, they tend to rise to the surface, unless they form at the bottom and attach themselves there. This ice, called anchor ice, may continue to grow as additional ice freezes to that already formed.

3202. Land or Glacial Ice

Figure 3202 Ice of land origin is formed on land by the freezing of freshwater or the compacting of snow as layer upon layer adds to the pressure on that beneath. Under great pressure, ice becomes slightly plastic, and is forced downward along an inclined surface. If a large area is relatively flat, as on the Antarctic plateau, or if the outward flow is obstructed, as on Greenland, an **ice cap** forms and remains essentially permanent. The thickness of these ice caps ranges from nearly 1 kilometer on Greenland to as much as 4.5 kilometers on the Antarctic Continent. Where ravines or mountain passes permit flow of the ice, a **glacier** is formed. This is a mass of snow and ice which continuously flows to lower levels, exhibiting many of the characteristics of rivers of water. The flow may be more than 30 meters per day, but is generally much less. When a glacier reaches a comparatively level area, it spreads out. When a glacier flows into the sea, sections will break off and float away as **icebergs**. Icebergs may be described as tabular or non-tabular. Non-tabular icebergs can be further described as domed, pinnacled, tabular (Figure 3202a) and (Figure 3202b), wedged, drydocked, or as an ice island. A

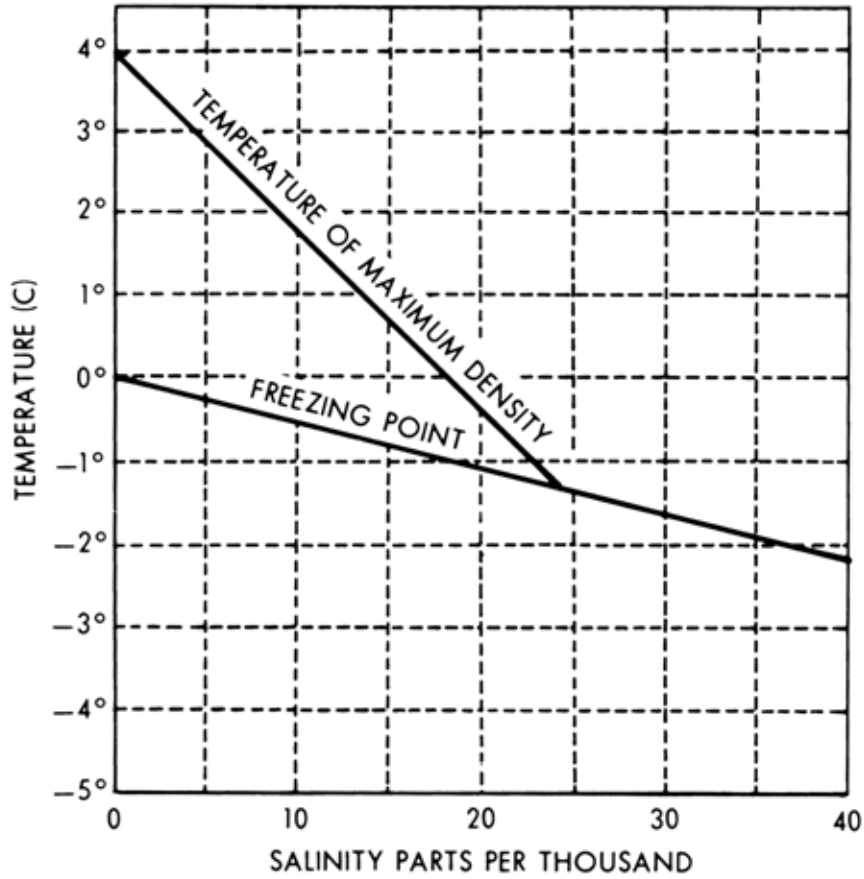

Figure 3201. Relationship between temperature of maximum density and freezing point for water of varying salinity.



Figure 3202a. A tabular iceberg. Photographer: Lieutenant Elizabeth Crapo, NOAA Corp.

floating iceberg seldom melts uniformly because of lack of uniformity in the ice itself, differences in the temperature above and below the waterline, exposure of one side to the

sun, strains, cracks, mechanical erosion, etc. The inclusion of rocks, silt, and other foreign matter further accentuates the differences. As a result, changes in equilibrium take

place, which may cause the berg to tilt or capsize. Parts of it may break off or **calve**, forming separate smaller bergs. A relatively large piece of floating ice, generally extending 1 to 5 meters above the sea surface and 5 to 15 meters length at the waterline, is called a **bergy bit**. A smaller piece of ice large enough to inflict serious damage to a vessel is called a **growler** because of the noise it sometimes makes as it bobs up and down in the sea. Growlers extend less than 1 meter above the sea surface and about a length of about 5 to

15 meters. Growlers can be greenish or have semi-transparent blue tones that blend into the seawater and make them particularly difficult to detect visually. Bergy bits and growlers are usually pieces calved from icebergs, but they may be the remains of a mostly melted iceberg.

The population of Antarctic icebergs includes many icebergs in the larger size classes compared to the Arctic population. Tabular icebergs can have linear dimensions of many kilometers, and for the very largest, up to in excess of a hundred kilometers.

One danger from icebergs is their tendency to break or capsize. Soon after a berg is calved, while remaining in high latitude waters, 60-80% of its bulk is submerged. But as the berg drifts into warmer waters the underside begins to melt, and as the berg becomes unstable, it can sometimes roll over. Eroded icebergs that have not yet capsized have a jagged and possibly dirty appearance. A recently capsized berg will usually be smooth, clean, and curved in appearance. Previous waterlines at odd angles can sometimes be seen after progressive tilting or one or more capsizings.

The stability of a berg can sometimes be noted by its reaction to ocean swells. The livelier the berg, the more unstable it is. It is extremely dangerous for a vessel to approach an iceberg closely, even one which appears stable, because in addition to the danger from capsizing, unseen cracks can cause icebergs to split in two or calve off large chunks. These sections can be many times the size of a vessel and displace huge volumes of water as they break away or turn over, inducing an immense swell.

Figure 3202 Another danger is from underwater extensions, called **rams**, which are usually formed due to melting or erosion above the waterline at a faster rate than below. Rams may also extend from a vertical ice cliff, also known as an **ice front**, which forms the seaward face of a massive ice sheet or floating glacier; or from an **ice wall**, which is the ice cliff forming the seaward margin of a glacier which is aground. In addition to rams, large portions of an iceberg may extend well beyond the waterline at greater depths.

Strangely, icebergs may be helpful to the mariner in some ways. The melt water found on the surface of icebergs is a source of freshwater, and in the past some daring seamen have made their vessels fast to icebergs which, because they are affected more by currents than the wind, have proceeded to tow them out of the ice pack.

Icebergs can be used as a navigational aid in extreme latitudes where charted depths may be in doubt or non-existent. Since an iceberg (except a large tabular berg) must



Figure 3202b. Pinnacled iceberg. Photographer: Lieutenant Philip Hall, NOAA Corp.

be at least as deep in the water as it is high to remain upright, a grounded berg can provide an estimate of the minimum water depth at its location. Water depth will be at least equal to the exposed height of the grounded iceberg. Grounded bergs remain stationary while current and wind move sea ice past them. Drifting ice may pile up against the up current side of a grounded berg.

3203. Iceberg Drift

Icebergs extend a considerable distance below the surface and have relatively small "sail areas" compared to their underwater body. Therefore, the near-surface current is primarily responsible for drift; however, observations have shown that wind can govern iceberg drift at a particular location or time.

The relative influence of currents and winds on the drift of an iceberg varies according to the direction and magnitude of the forces acting on its sail area and subsurface cross-sectional area. The resultant force therefore involves the proportions of the iceberg above and below the sea surface in relation to the velocity and depth of the current, and the velocity and duration of the wind. Studies tend to show that, generally, where strong currents prevail, the current is dominant. In regions of weak currents, however, winds that blow for a number of hours in a steady direction materially affect the drift of icebergs.

As icebergs deteriorate through melting, erosion, and calving, observations indicate the height to draft ratio may approach 1:1 during their final stage of decay, when they are referred to as a dry dock, winged, horned, or pinnacle

iceberg. The height to draft ratios found for icebergs in their various stages are presented in Table 3203a. Since wind

<i>Iceberg type</i>	<i>Height to draft ratio</i>
Blocky or tabular	1:5
Rounded or domed	1:4
Picturesque or Greenland (sloping)	1:3
Pinnacled or ridged	1:2
Horned, winged, dry dock, or spired (weathered)	1:1

Table 3203a. Height to draft ratios for various types of icebergs.

tends to have a greater effect on shallow than on deep-draft icebergs, the wind can be expected to exert increasing influence on iceberg drift as the iceberg deteriorates.

Simple equations that approximate iceberg drift have been formulated. However, there is uncertainty in the water and air drag coefficients associated with iceberg motion. Values for these parameters not only vary from iceberg to iceberg, but they probably change for the same iceberg over its period of deterioration. Further, the change in the iceberg shape that results from deterioration over time is not well known.

Present investigations utilize an analytical approach, facilitated by computer modeling, in which the air and water drag coefficients are varied within reasonable limits. Combinations of these drag values are then used in several increasingly complex water models that try to duplicate observed iceberg trajectories. The results indicate that with a wind-generated current, Coriolis force, and a uniform wind, but without a gradient current, small and medium icebergs will drift with the percentages of the wind as given in Table 3203b. The drift will be to the right in the Northern Hemisphere and to the left in the Southern Hemisphere.

<i>Wind Speed (knots)</i>	<i>Ice Speed/Wind Speed (percent)</i>		<i>Drift Angle (degrees)</i>	
	<i>Small Berg</i>	<i>Med. Berg</i>	<i>Small Berg</i>	<i>Med. Berg</i>
10	3.6	2.2	12°	69°
20	3.8	3.1	14°	55°
30	4.1	3.4	17°	36°
40	4.4	3.5	19°	33°
50	4.5	3.6	23°	32°
60	4.9	3.7	24°	31°

Table 3203b. Drift of iceberg as percentage of wind speed.

The movement of icebergs can be counter-intuitive. In the Antarctic an example is provided by the massive iceberg B15A (length 150 km) when it was located adjacent to Ross Island in the Southern Ross Sea. Its presence had a huge impact on wild life in the area and on access to McMurdo Sound and the McMurdo station. The prevailing wind in its locality is typically offshore from the ice shelf. When the winds are light the berg can be observed to drift slowly away from the edge of the shelf. But when the wind strengthened, the berg suddenly moved quickly south (i.e. upwind) to collide with the sea floor. A possible explanation of such behavior can be found in likely changes in the sub-surface ocean currents. While the wind was strong, surface water was advected away from the shelf, to be replaced by water drawn in from the north at greater depths. The iceberg would then be driven south by the increased velocity of the sub-surface current which would have acted on its sides for a large fraction of its depth and on the basal surface of the berg.

It is important to note that iceberg drift is frequently influenced by the presence of eddies and meanders of mean ocean currents. These oceanic features make iceberg trajectory predictions challenging. For example, eddies and meanders are frequently found in the North Atlantic where

the Labrador Current meets the North Atlantic Current near the tail of the Grand Banks. In the Southern Hemisphere, predicting iceberg and sea ice drift is affected by the Southern Orkney islands. Careful attention to near real time observations from satellite imagery and drifting buoys can help improve the understanding of iceberg drift in these complex oceanographic environments.

3204. Icebergs in the North Atlantic

Sea level glaciers exist on a number of landmasses bordering the northern seas, including Alaska, Greenland, Svalbard (Spitsbergen), Zemlya Frantsa-Iosifa (Franz Josef Land), Novaya Zemlya, and Severnaya Zemlya (Nicholas II Land). Except in Greenland and Franz Josef Land, the rate of calving is relatively slow, and the few icebergs produced melt near their points of formation. Many of those produced along the western coast of Greenland, however, are eventually carried into the shipping lanes of the North Atlantic, where they constitute a major menace to ships. Those calved from Franz Josef Land glaciers drift southwest in the Barents Sea to the vicinity of Bear Island.

Generally the majority of icebergs produced along the east coast of Greenland remain near their source. However,

a small number of bergy bits, growlers, and small icebergs are transported south from this region by the East Greenland Current around Kap Farvel at the southern tip of Greenland and then northward by the West Greenland Current into Davis Strait to the vicinity of 67°N. Relatively few of these icebergs menace shipping, but some are carried to the south and southeast of Kap Farvel by a counterclockwise current gyre centered near 57°N and 43°W.

The main source of the icebergs encountered in the North Atlantic is the west coast of Greenland between 67°N and 76°N, where approximately 10,000–15,000 icebergs are calved each year. In this area there are about 100 low-lying coastal glaciers, 20 of them being the principal producers of icebergs. Of these 20 major glaciers, 2 located in Disko Bugt between 69°N and 70°N are estimated to contribute 28 percent of all icebergs appearing in Baffin Bay and the Labrador Sea. The West Greenland Current carries icebergs from this area northward and then westward until they encounter the south flowing Labrador Current. West Greenland icebergs generally spend their first winter locked in the Baffin Bay pack ice; however, a large number can also be found within the sea ice extending along the entire Labrador coast by late winter.

During the next spring and summer they are transported farther southward by the Labrador Current. The general drift patterns of icebergs that are prevalent in the eastern portion of the North American Arctic are shown in Figure 3204a. Observations over a 117-year period (1900-2016) show that an average of 486 icebergs per year reach latitudes south of 48 N; approximately 10 percent of this total will be carried south of the Grand Banks (43 N) before they melt. Icebergs may be encountered during any part of the year, but in the Grand Banks area they are most numerous during spring. The maximum monthly average of iceberg sightings below 48 N occurs during April, May and June, with May having the highest average of 151. The distribution of the Davis Strait-Labrador Sea pack ice appears to influence the melt rate of the icebergs as they drift south. Sea ice decreases iceberg erosion by damping waves and holds surface water temperatures below 0 C, so as the extent of the sea ice increases the icebergs will tend to survive longer. Stronger than average northerly or northeasterly winds during late winter and spring will accelerate sea ice drift to the south, which also may prolong an iceberg's survival. The large inter-annual variations in the number of icebergs calved from Greenland's glaciers, makes forecasting the length and severity of an iceberg season very challenging.

The variation from average conditions is considerable. More than 2,202 icebergs have been sighted south of latitude 48 N in a single year (1984), while in 1966 and 2006 not a single iceberg was encountered in this area. In 1940, 1958, and 2010, only one iceberg was observed south of 48 N. More recently, within the two-year period from 2013-2014, the number of icebergs south of latitude 48 N varied from 13 in 2013 to 1546 in 2014. The variability of the ice-

berg population in the transatlantic shipping lanes is related to environmental conditions. Average iceberg and pack ice limits in this area during May are shown in Figure 3204b. Beyond these average limits, icebergs have been reported in the vicinity of Bermuda, the Azores, and within 500 kilometers of Great Britain.

Pack ice may also be found in the North Atlantic, some having been brought south by the Labrador Current and some coming through Cabot Strait after having formed in the Gulf of St. Lawrence.

3205. Sea Ice

Sea ice forms by the freezing of seawater and accounts for 95 percent by area of all ice encountered. The first indication of the formation of new sea ice (up to 10 centimeters in thickness) is the development of small individual, needle-like crystals of ice, called **spicules**, which become suspended in the top few centimeters of seawater. These spicules, also known as **frazil ice**, give the sea surface an oily appearance. **Grease ice** is formed when the spicules coagulate to form a soupy layer on the surface, giving the sea a matte appearance. Calm wind conditions are favorable for initial sea ice growth but sea ice can form in most wind conditions given sufficiently cold water temperatures. The next stage in sea ice formation occurs when **shuga**, an accumulation of spongy white ice lumps a few centimeters across, develops from grease ice. Upon further freezing, and depending upon wind exposure, sea state, and salinity, shuga and grease ice develop into **nilas**, an elastic crust of high salinity, up to 10 centimeters in thickness, with a matte surface, or into **ice rind**, a brittle, shiny crust of low salinity with a thickness up to approximately 5 centimeters. A layer of 5 centimeters of freshwater ice is brittle but strong enough to support the weight of a heavy man. In contrast, the same thickness of newly formed sea ice will not support more than about 10 percent of this weight, although its strength varies with the temperatures at which it is formed; very cold ice supports a greater weight than warmer ice. As it ages, sea ice becomes harder and more brittle.

New ice may also develop from slush which is formed when snow falls into seawater which is near its freezing point, but colder than the melting point of snow. The snow does not melt, but floats on the surface, drifting with the wind into beds. If the temperature then drops below the freezing point of the seawater, the slush freezes quickly into a soft ice similar to shuga.

Sea ice is exposed to several forces, including currents, waves, tides, wind, and temperature variations. In its early stages, its plasticity permits it to conform readily to virtually any shape required by the forces acting upon it. As it becomes older, thicker, more brittle, and exposed to the influence of wind and wave action, new ice usually separates into circular pieces from 30 centimeters to 3 meters in diameter and up to approximately 10 centimeters in thickness with raised edges due to individual pieces striking against

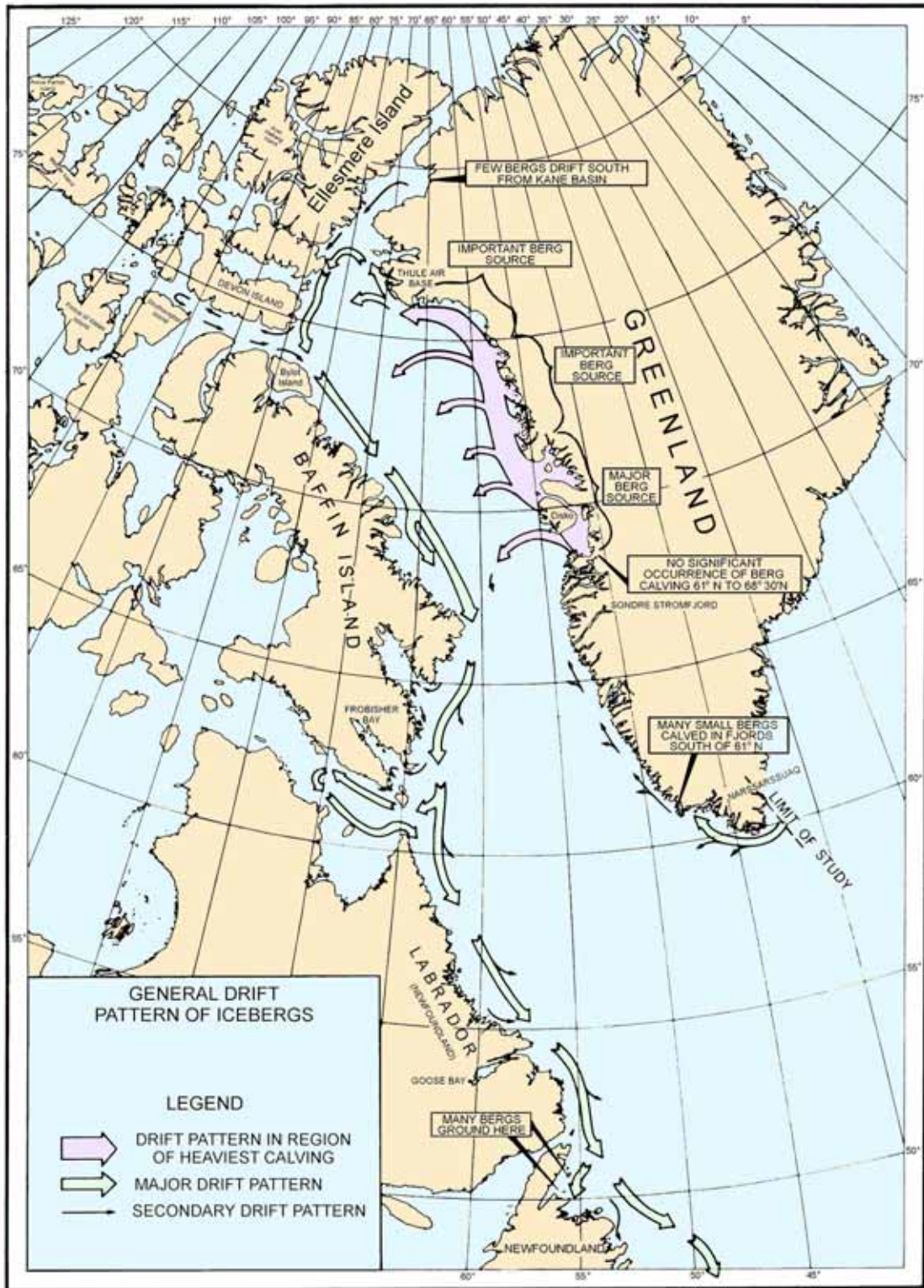

Figure 3204a. General drift patterns of icebergs in Baffin Bay, Davis Strait, and Labrador Sea.

each other. These circular pieces of ice are called **pancake ice** (Figure 3205) and may break into smaller pieces with strong wave motion. Any single piece of relatively flat sea

ice less than 20 meters across is called an **ice cake**. With continued low temperatures, individual ice cakes and pancake ice will, depending on wind or wave motion, either

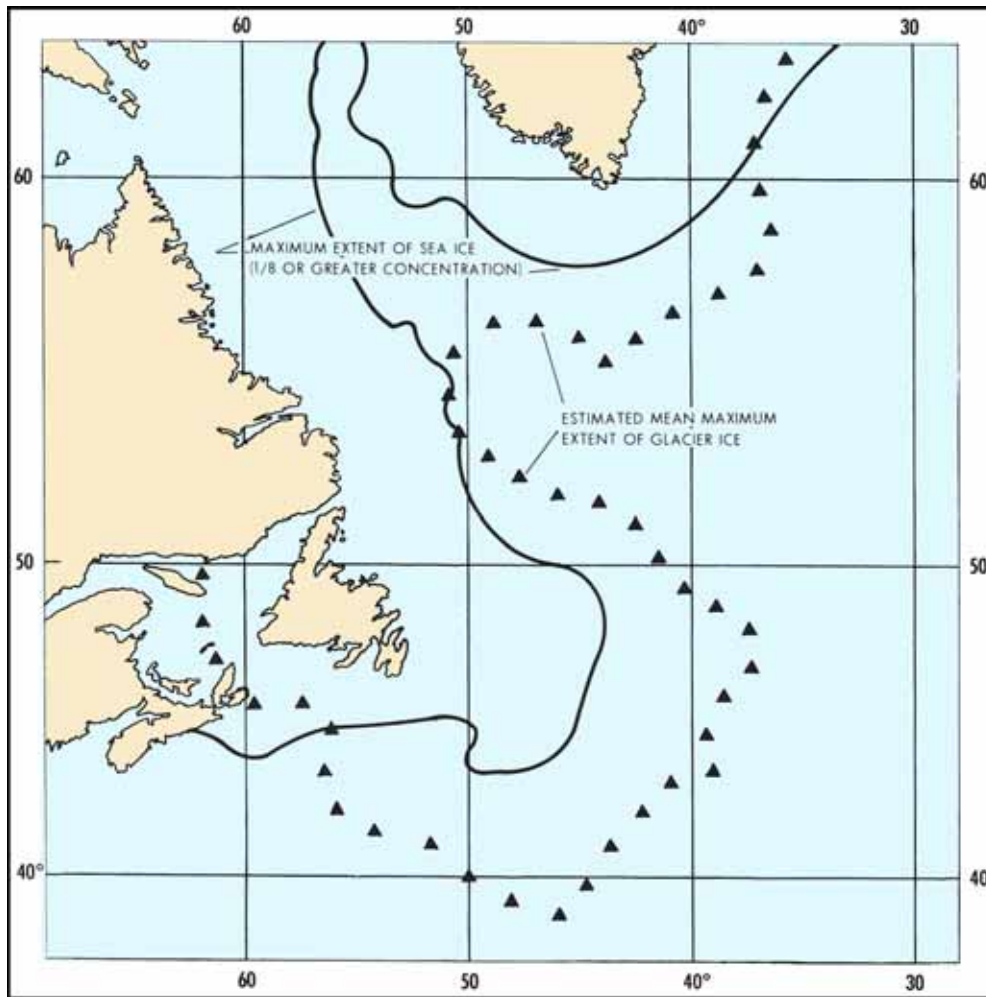

Figure 3204b. Average iceberg and pack ice limits during the month of May.



Figure 3205. Pancake ice. Image courtesy of John Farrell, U.S. Arctic Commission, Healy 1202.

freeze together to form a continuous sheet or unite into pieces of ice 20 meters or more across. These larger pieces are then called **ice floes**, which may further freeze together

to form an ice covered area greater than 10 kilometers across known as an **ice field**. In wind sheltered areas thickening ice usually forms a continuous sheet before it can develop into the characteristic ice cake form. When sea ice reaches a thickness of between 10 to 30 centimeters it is referred to as **gray** and **gray-white ice**, or collectively as **young ice**, and is the transition stage between nilas and **first-year ice**. Sea ice may grow to a thickness of 10 to 13 centimeters within 48 hours, after which it acts as an insulator between the ocean and the atmosphere progressively slowing its further growth. Sea ice may grow to a thickness of between 2 to 3 meters in its first winter. Ice which has survived at least one summer's melt is classified as **old ice**. If it has survived only one summer's melt it may be referred to as **second-year ice**, but this term is seldom used today. Old ice which has survived at least two summers' melt is known as **multiyear ice** and is almost salt free. This term is increasingly used to refer to any ice more than one season old. Old ice can be recognized by a bluish tone to its surface color in contrast to the greenish tint of first-year ice; both first year and multiyear ice is often covered with snow. An-

other sign of old ice is a smoother, more rounded appearance due to melting/refreezing and weathering by wind-driven snow and spray

Greater thicknesses in both first and multiyear ice are attained through the deformation of the ice resulting from the movement and interaction of individual floes. Deformation processes occur after the development of new and young ice and are the direct consequence of the effects of winds, tides, and currents. These processes transform a relatively flat sheet of ice into pressure ice which has a rough surface. **Bending**, which is the first stage in the formation of pressure ice, is the upward or downward motion of thin and very plastic ice. Rarely, **tenting** occurs when bending produces an upward displacement of ice forming a flat sided arch with a cavity beneath. More frequently, however, **rafting** takes place as one piece of ice overrides another. When pieces of first-year ice are piled haphazardly over one another forming a wall or line of broken ice, referred to as a **ridge**, the process is known as **ridging**. Ridges on sea ice are generally about 1 meter high and 5 meters deep, but under considerable pressure may attain heights of 20 meters and depths of 50 meters in extreme cases. Pressure ice with topography consisting of numerous mounds or hillocks is called hummocked ice, each mound being called a hummock. The corresponding underwater feature is known as a bummock. In the Antarctic **Seasonal Sea Ice Zone (SSIZ)**, rafting makes an important contribution to the growth of the thickness of the ice. One immediate danger of rafting occurs when the thickness of the rafted ice is double that of its constituent pieces. This process shifts the distribution of ice thickness classes to thicker ice. Another major contributor to the growth in thickness of Antarctic ice is accumulation of snow on the upper surface. In addition the added weight of snow can depress the surface of the underlying ice to below the level of the sea water. Sea water can then infiltrate the snow to form snow-ice. Sea water will find a path into the snow from the outer edges of floes and from underneath the floe via cracks in the ice.

The motion of an individual floe is driven by its interaction with the ocean current and wind, as well as with adjacent floes or obstacles such as a coastline, or icebergs. Momentum is transferred from the wind and current to the floe through their interaction with the roughness of the upper and lower surfaces at various scales, and the "sail" effect of the upper ridges, sub-surface keels, and the outer edges of a floe. The motion of adjacent floes is seldom equal. Some ice floes are in rotary motion as they tend to trim themselves into the wind. Since ridges extend below as well as above the surface, the deeper ones are influenced more by currents at those depths. When a strong wind blows in the same direction for a considerable period so that there is a net convergence in the motion of a field of sea ice floes, each floe exerts pressure on the next one, and as the effect accumulates over time, the pressure becomes tremendous.

The alternate melting and growth of sea ice, combined with the continual motion of various floes that results in separation as well as consolidation, causes widely varying conditions within the ice cover itself. The mean areal density, or concentration, of pack ice in any given area is expressed in tenths. Concentrations range from:

Open water (total concentration of all ice is < one tenth)

Very open pack (1-3 tenths concentration)

Open pack (4-6 tenths concentration)

Close pack (7-8 tenths concentration)

Very close pack (9-10 to <10-10 concentration)

Compact or consolidated pack (100% coverage)

The extent to which an ice cover of varying concentrations can be penetrated by a vessel varies from place to place and with changing weather conditions. With a concentration of 1 to 3 tenths in a given area, an unreinforced vessel can generally navigate safely, but the danger of receiving heavy damage is always present. When the concentration increases to between 3 and 5 tenths, the area becomes only occasionally accessible to an unreinforced vessel, depending upon the wind and current. With concentrations of 5 to 7 tenths, the area becomes accessible only to ice strengthened vessels, which on occasion will require icebreaker assistance. Navigation in areas with concentrations of 7 tenths or more should only be attempted by icebreakers.

Sea ice which is formed in situ from seawater or by the freezing of pack ice, of any age, to the shore and which remains attached to the coast, to an ice wall, to an ice front, or between shoals is called **fast ice**. The width of this fast ice varies considerably and may extend for a few meters or several hundred kilometers in bays and other sheltered areas. Fast ice, often augmented by annual snow accumulations, may attain a thickness of over 2 meters above the sea surface.

An **ice shelf** forms where land ice flows across the coastline and becomes afloat. Ice shelves are comprised primarily of meteoric ice, ice formed from densification of precipitated snow. These shelves are typically formed by the coalescence of ice flow from multiple ice streams. Where a main ice stream / glacier contributes to the shelf, they may be called glacier tongues. Some sections of some Antarctic ice shelves may also have a considerable fraction of the thickness comprised of marine ice which has accreted to the base of the meteoric ice either by direct freezing of sea water or by accumulation of frazil ice formed in the water column beneath the ice shelf. There may also be a net input to the thickness by accumulation of snow on the upper surface. Massive ice shelves, where the ice thickness reaches several hundred meters, are found in both the Arctic and Antarctic.

Within the ice cover, openings may develop resulting from a number of deformation processes. Long, jagged cracks may appear first in the ice cover or through a single floe. When these cracks open and reach lengths of a few

meters to many kilometers, they are referred to as **fractures**. If they widen further to permit passage of a ship, they are called **leads**. In winter, a thin coating of new ice may cover the water within a lead, but in summer the water usually remains ice-free until a shift in the movement forces the two sides together again. A lead ending in a pressure ridge or other impenetrable barrier is a **blind lead**.

A lead between pack ice and shore is a **shore lead**, and one between pack and fast ice is a **flaw lead**. Navigation in these two types of leads is dangerous, because if the pack ice closes, the ship can be caught between the two, and driven aground or caught in the shear zone in between.

A **polynya** is an area within pack ice where there is: open water; or ice concentration lower than in the surrounding pack. There are two types of polynya: **sensible-heat polynya**, and **latent-heat polynya**. “Sensible-heat” polynyas occur where there is an upwelling of relatively warmer water that melts the sea ice or prevents it forming in that area. “Latent-heat” polynyas are caused by motion of the pack ice relative to something. Thus they may result from motion of the ice away from an obstacle, such as a coastline or grounded iceberg which acts as a barrier against incursion of pack ice into the area from elsewhere, or even by divergence of the pack ice. The name comes from the process whereby latent heat released by the freezing of water is lost to the atmosphere. **Recurring polynyas** are located where the required conditions regularly occur.

In the Arctic, sensible-heat polynyas are often the site of historical native settlements, where the open water of the polynya allows fishing and hunting at times before the regular seasonal ice breakup. Thule, Greenland is an example. The presence of a sensible heat polynya can also ameliorate the local climate.

In both polar regions, latent-heat polynyas occur at various locations around the coast, where prevailing off-shore wind sweeps the area clear of newly formed ice. They can be very large in area and typically produce very large amounts of sea ice. This happens through the loss of heat from the water surface to the atmosphere and rapid freezing of the surface water. The freezing of the water and export of the relatively fresh ice also leaves excess salt in the water column which increases the salinity and thus density of the water. This cold dense water sinks to the bottom and may eventually contribute to the generation of “bottom-water” and to the deep overturning circulation of the world’s oceans.

The majority of icebergs found in the Antarctic originated from the massive ice shelves and glacier tongues that fringe the continental ice sheet. Most of the ice discharged from the Antarctic ice sheet passes through those regions of floating ice, which together comprise about 40% of the coastline. The icebergs have either calved directly from those ice margins or from the resultant icebergs. Icebergs formed in this manner are called **tabular icebergs**, having a box like shape with horizontal dimensions measured in kilometers. The thickness of icebergs can range up to several

hundred meters. In the Antarctic, the thickness is typically 200-300 m, and in extreme cases can be 500 m or more, with heights above the sea surface of 25-40 meters and approaching 60 meters. See Figure 3202a. The largest Antarctic ice shelves are the Ross Ice Shelf at the southern boundary of the Ross Sea and the Filchner-Ronne Ice Shelf in the Weddell Sea.

The expression “tabular iceberg” is generally not applied to icebergs which break off from Arctic ice shelves; similar formations there are called **ice islands**. These originate when shelf ice, such as that found on the northern coast of Greenland and in the bays of Ellesmere Island, breaks up. As a rule, Arctic ice islands are not as large as the tabular icebergs found in the Antarctic. They attain a thickness of up to 55 meters and on the average extend 5 to 7 meters above the sea surface. Both tabular icebergs and ice islands possess a gently rolling surface. Because of their deep draft, they are influenced much more by current than wind.

3206. Thickness of Sea Ice

Sea ice has been observed to grow to a thickness of almost 3 meters during its first year. However, the thickness of first-year ice that has not undergone deformation does not generally exceed 2 meters. In coastal areas where the melting rate is less than the freezing rate, the thickness may increase during succeeding winters, being augmented by compacted and frozen snow, until a maximum thickness of about 3.5 to 4.5 meters may eventually be reached. Old sea ice may also attain a thickness of over 4 meters in this manner, or when summer melt water from its surface or from snow cover runs off into the sea and refreezes under the ice where the seawater temperature is below the freezing point of the fresher melt water.

The growth of sea ice is dependent upon a number of meteorological and oceanographic parameters. Such parameters include air temperature, initial ice thickness, snow depth, wind speed, seawater salinity and density, and the specific heats of sea ice and seawater. Investigations, however, have shown that the most influential parameters affecting sea ice growth are air temperature, wind speed, snow depth and initial ice thickness. Many complex equations have been formulated to predict ice growth using these four parameters. However, except for air temperature and wind speed, these parameters are not easily observed for remote polar locations.

Field measurements suggest that reasonable growth estimates can be obtained from air temperature data alone. Various empirical formulae have been developed based on this premise. All appear to perform better under thin ice conditions when the temperature gradient through the ice is linear, generally true for ice less than 100 centimeters thick. Differences in predicted thicknesses between models generally reflect differences in environmental parameters (snowfall, heat content of the underlying water column, etc.) at the measurement site. As a result, such equations must be considered partially site specific and their general use ap-

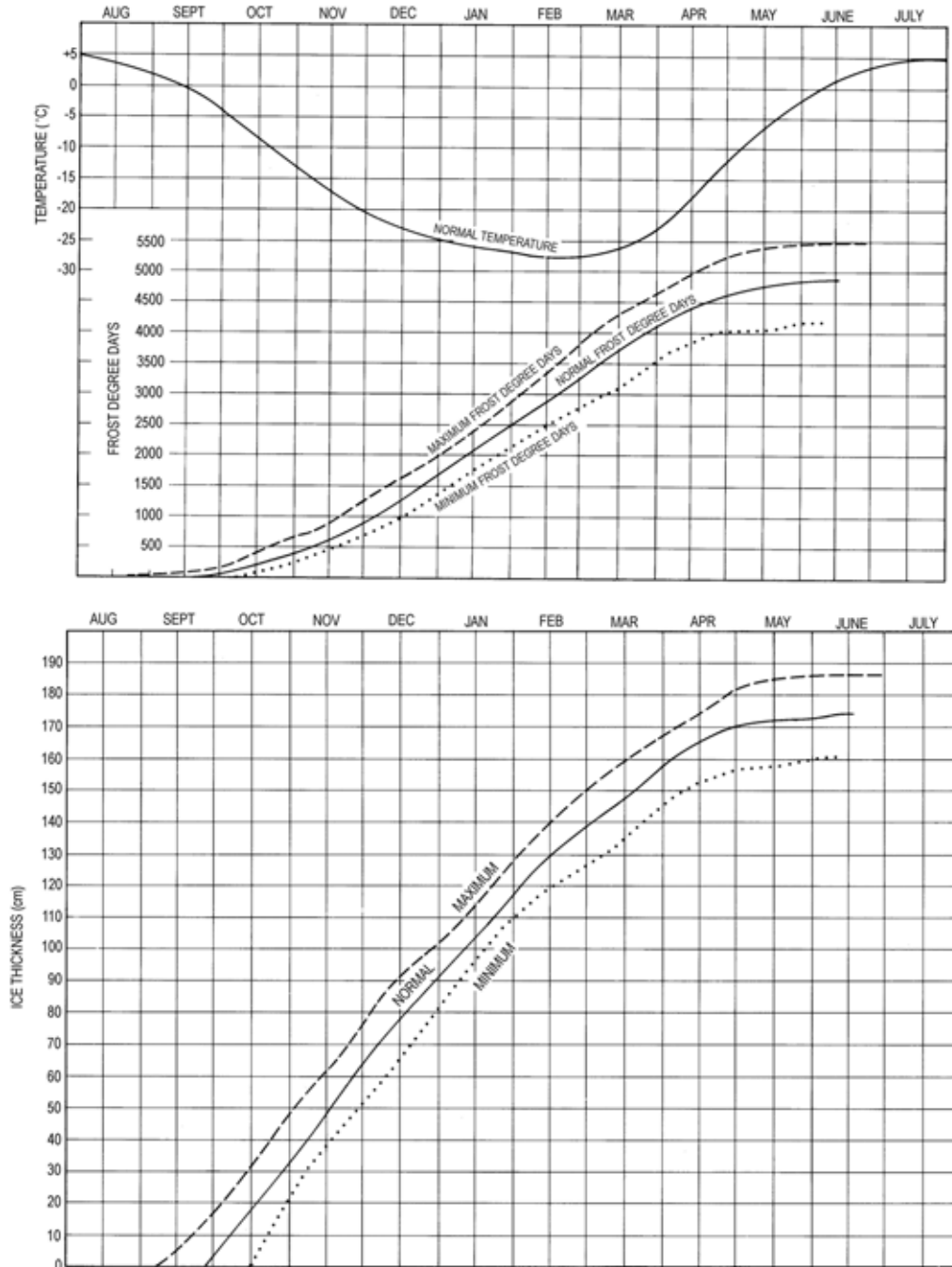

Figure 3206a. Relationship between accumulated frost degree days and theoretical ice thickness at Point Barrow, Alaska.

proached with caution. For example, applying an equation derived from central Arctic data to coastal conditions or to Antarctic conditions could lead to substantial errors. For this reason Zubov's formula is widely cited as it represents an average of many years of observations from the Russian Arctic:

$$h^2 + 50h = 8\phi$$

where h is the ice thickness in centimeters for a given day and

ϕ is the cumulative number of frost degree days in degrees Celsius since the beginning of the freezing season.

A **frost degree day** (or **freezing degree day**) is defined as a day with a mean temperature of 1 below freezing. The base most commonly used is the freezing point of freshwater (0° C). If, for example, the mean temperature on a given day is 5 below freezing, then five frost degree days are noted for that day. These frost degree days are then added to those noted the next day to obtain an accumulated value, which is then

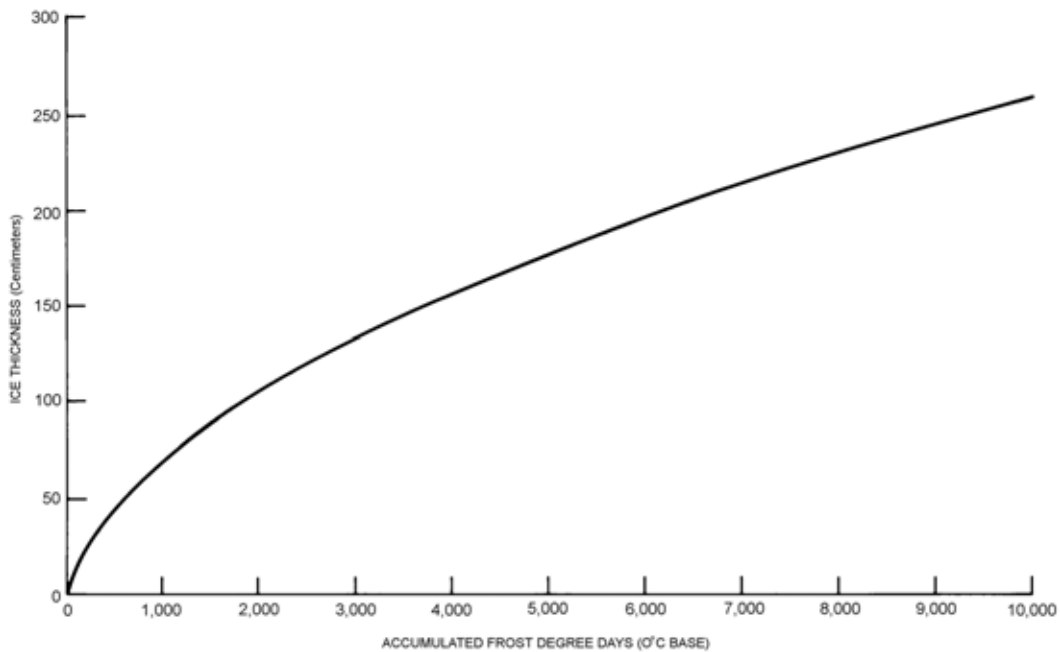

Figure 3206b. Relationship between accumulated frost degree days ($^{\circ}\text{C}$) and ice thickness (cm).

added to those noted the following day. This process is repeated daily throughout the ice growing season. Temperatures usually fluctuate above and below freezing for several days before remaining below freezing. Therefore, frost degree day accumulations are initiated on the first day of the period when temperatures remain below freezing. The relationship between frost degree day accumulations and theoretical ice growth curves at Point Barrow, Alaska is shown in Figure 3206a. Figure 3206b graphically depicts the relationship between accumulated frost degree days ($^{\circ}\text{C}$) and ice thickness in centimeters.

During winter, the ice usually becomes covered with snow, which insulates the ice beneath and tends to slow down its rate of growth. This thickness of snow cover varies considerably from region to region as a result of differing climatic conditions. Its depth may also vary widely within very short distances in response to variable winds and ice topography. While this snow cover persists, up to 90% of the incoming radiation is reflected back to space. Eventually, however, the snow begins to melt, as the air temperature rises above 0°C in early summer and resulting freshwater forms puddles on the surface. These puddles absorb the incoming radiation and rapidly enlarge as they melt the surrounding snow or ice. Eventually the puddles penetrate to the bottom surface of the floes forming **thawholes**. This slow process is characteristic of ice in the Arctic Ocean and seas where movement is restricted by the coastline or islands. Where ice is free to drift into warmer waters (e.g., the Antarctic, East Greenland, and the Labrador Sea), decay is accelerated in response to wave erosion as well as warmer air and sea temperatures.

3207. Salinity of Sea Ice

When sea ice crystals first form, the salt collects into brine droplets. The brine is normally expelled back into the ocean water. Some of the droplets can be trapped in the pockets between ice crystals and, because it would take much colder temperatures to freeze, the liquid brine droplets remain trapped in the pockets between the ice crystals. As the freezing process continues, some brine drains out of the ice, decreasing the salinity of the sea ice. At lower temperatures, freezing takes place faster, trapping a greater amount of salt in the ice.

Depending upon the temperature, the trapped brine may either freeze or remain liquid, but because its density is greater than that of the pure ice, it tends to settle down through the pure ice, leaching into the sea. As it does so, the ice gradually freshens, becoming clearer, stronger, and more brittle. By the time sea ice survives multiple melt seasons, much of the brine has been expelled, and may be suitable to replenish the freshwater supply of a ship. Even though the brine has been expelled, other contaminants may be present that would prevent the meltwater from being consumable. Icebergs, having formed from precipitation, contain no salt, and uncontaminated melt water obtained from them is fresh.

The settling out of the brine gives sea ice a honeycomb structure which greatly hastens its disintegration when the temperature rises above freezing. In this state, when it is called **rotten ice**, much more surface is exposed to warm air and water, and the rate of melting is increased. In a day's time, a floe of apparently solid ice several inches thick may disappear completely.

3208. Density of Ice

The density of freshwater ice at its freezing point is 0.917gm/cm^3 . Newly formed sea ice, due to its salt content, is more dense. The density decreases as the ice freshens. By the time it has shed most of its salt, sea ice is less dense than freshwater ice, because ice formed in the sea contains voids left by brine leaching. Ice having no salt but containing air to the extent of 8 percent by volume (an approximately maximum value for sea ice) has a density of 0.845 gm/cm^3 .

The density of land ice varies over even wider limits. Most land ice is formed by compacting of snow. This results in the entrapping of relatively large quantities of air. **Névé**, a snow which has become coarse grained and compact through temperature change, forming the transition stage to glacier ice, may have an air content of as much as 50 percent by volume. By the time the ice of a glacier reaches the sea, its density approaches that of freshwater ice. A sample taken from an iceberg on the Grand Banks had a density of 0.899gm/cm^3 .

When ice floats, part of it is above water and part is below the surface. The percentage of the mass below the surface can be found by dividing the average density of the ice by the density of the water in which it floats. Thus, if an iceberg of density 0.920 floats in water of density 1.028 (corresponding to a salinity of 35 parts per thousand and a temperature of -1 C), 89.5 percent of its mass will be below the surface.

3209. Drift of Sea Ice

In 1893, Fridtjof Nansen, a 32-year old Norwegian explorer aboard the vessel *Fram* noted that floes of sea ice did not drift directly downwind. He documented this phenomenon and shared the observations with his colleague Vagn Walfrid Ekman. In his 1902 doctoral thesis, Ekman mathematically described the wind forcing on surface waters. The result is described as **Ekman Transport**, and was further refined at various depths as the **Ekman Spiral**.

Although in some cases, surface currents have some effect upon the drift of pack ice, the principal factor is wind. As described above, the earth's rotation imparts an apparent force (Coriolis force) such that ice does not drift directly downwind, but varies from this direction, depending upon the force of the surface wind and the ice thickness. The force is a consequence of physics related to the rotation of the earth about its axis. The force is zero at the equator and increases with increasing latitude. In the Northern Hemisphere, this drift is to the right of the direction toward which the wind blows, and in the Southern Hemisphere it is to the left. The relationship between surface wind speed, ice thickness, and drift angle was derived theoretically for the drift of consolidated pack under equilibrium (a balance of forces acting on the ice) conditions, and shows that the drift angle increases with increasing ice thickness and decreasing surface wind speed. See Figure 3209. A slight increase also occurs with higher latitude.

In the Antarctic, these effects on the movement of pack ice about the continent contribute to the pattern of spatial distribution of the ice and the direction of the drift of the ice. Near to the coast the drift is from east to west, and further out the drift is from the west to the east. The effect of the Coriolis force is to keep the pack ice in the near coastal drift belt close to the coast. The passage of storms modifies this overall movement pattern. In very general terms, when a low pressure system passes north of an area, the easterly component of the wind strengthens which can lead to ice being moved south towards the coast compacting into a belt locked against the coast.

In the Arctic, a comparable situation with a storm passing to the south of an area, would result in pack ice at the outer margins of the Arctic Ocean moving away from the coast and compacting seawards.

Since the cross-isobar deflection of the surface wind over the oceans is approximately 20° , the deflection of the ice varies as much as 70° to the right of the isobars, with low pressure on the left and high pressure on the right in the Northern Hemisphere. The positions of the low and high pressure areas are, of course, reversed in the Southern Hemisphere.

The rate of drift depends upon the roughness of the surface and the concentration of the ice. Percentages vary from approximately 0.25 percent to almost 8 percent of the surface wind speed as measured approximately 6 meters above the ice surface. Low concentrations of heavily ridged or hummocked floes drift faster than high concentrations of lightly ridged or hummocked floes with the same wind speed. Sea ice of 8 to 9 tenths concentrations and six tenths hummocking or close multiyear ice will drift at approximately 2 percent of the surface wind speed. Additionally, the response factors of 1/10th and 5/10ths ice concentrations, respectively, are approximately three times and twice the magnitude of the response factor for 9 tenths ice concentrations with the same extent of surface roughness. Isolated ice floes have been observed to drift as fast as 10 percent to 12 percent of strong surface winds.

The rates at which sea ice drifts have been quantified through empirical observation. The drift angle, however, has been determined theoretically for 10 tenths ice concentration. This relationship presently is extended to the drift of all ice concentrations, due to the lack of basic knowledge of the dynamic forces that act upon, and result in redistribution of sea ice, in the polar regions.

3210. Extent of Ice in the Sea

When an area of sea ice, no matter what form it takes or how it is disposed, is described, it is referred to as **pack ice**. In both polar regions the pack ice is a very dynamic feature, with wide deviations in its extent dependent upon changing oceanographic and meteorological phenomena. In winter the Arctic pack extends over the entire Arctic Ocean, and for a varying distance outward from it; the lim-

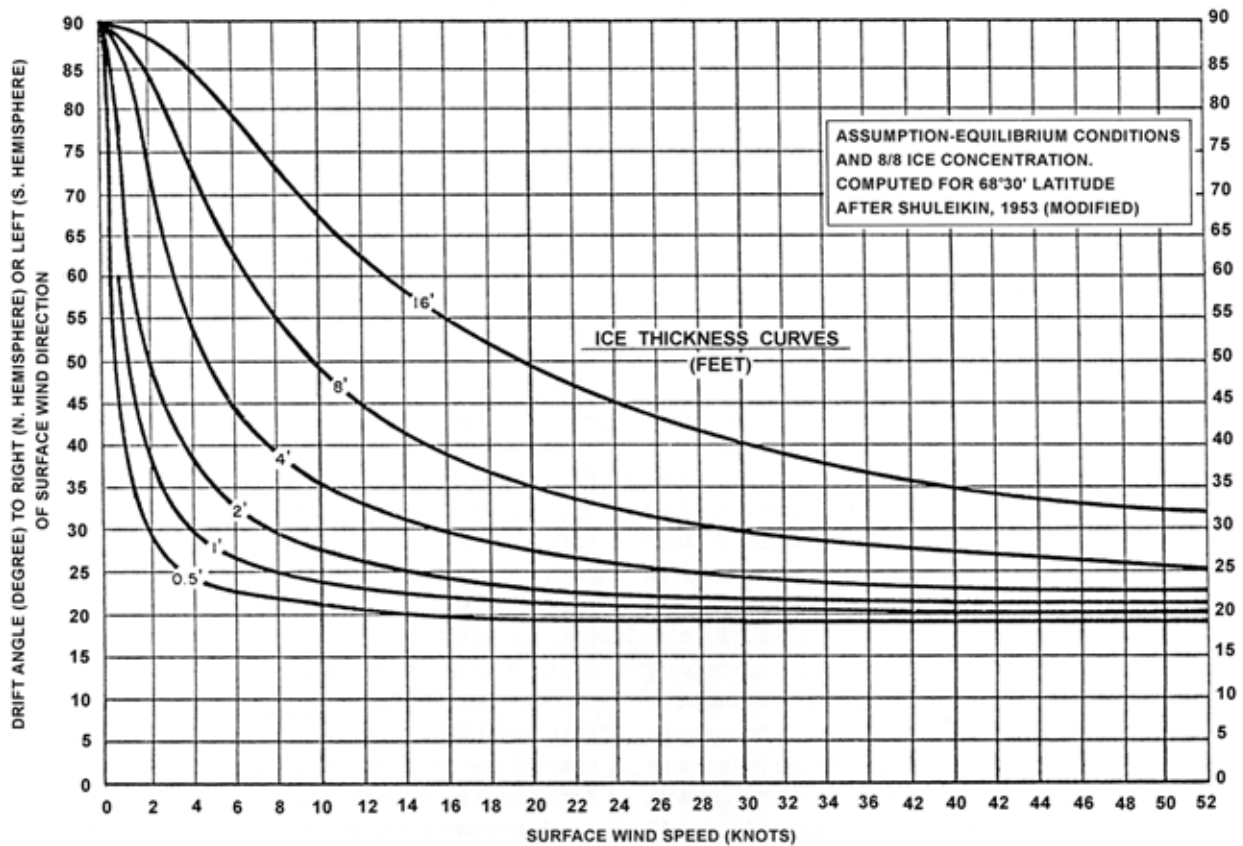

Figure 3209. Ice drift direction for varying wind speed and ice thickness.

its recede considerably during the warmer summer months. The average positions of the seasonal absolute and mean maximum and minimum extents of sea ice in the Arctic region are plotted in Figure 3210a. Each year a large portion of the ice from the Arctic Ocean moves outward between Greenland and Spitsbergen (Fram Strait) into the North Atlantic Ocean and is replaced by new ice. Because of this constant annual removal and replacement of sea ice, relatively little of the Arctic pack ice is more than 10 years old.

The average monthly Arctic sea ice extent for August has been decreasing dramatically over the last several decades as reflected in Figure 3210b. The phenomenon is discussed in more detail in Chapter 33.

Ice covers a large portion of the Antarctic waters and is probably the greatest single factor contributing to the isolation of the Antarctic Continent. The total area of sea ice varies between about 3 million square kilometers at its minimum and 19-20 million square kilometers at its maximum extent. The seasonal absolute and mean maximum and minimum positions of the Antarctic ice limit are shown in Figure 3210c. The overall minimum extent occurs in approximately February and maximum extent usually occurs in late September / early October. The extent progressively expands from its minimum with the onset of the colder months and waning sun-light. The distribution results from the increase in area where freezing is occurring together

with a net advection north of the sea ice. The northern limit in particular regions is influenced by wind and its variability. The extent can also be influenced by the total area and distribution of ice remaining from the previous winter. The pack ice completely surrounds the continent, forming an almost impassable barrier that extends northward on the average to about 54°S in the Atlantic and to about 62°S in the Pacific. As the ice retreats in the warmer months, opening up and disintegration of the pack ice allows navigation access to some coastal areas of the Antarctic. The date at which a particular area can be accessed depends on the local ice conditions. In some areas access to the fast ice edge can be attained early in the season, such as November, but access to the coast may not occur until January or February. In other areas, access to a region may not occur until later in the season. Access also depends very much on the capability of the vessel. In some seasons the coastal fast ice in front of some coastal stations has not broken out for one or more seasons preventing ship-access to those stations.

The **National Snow and Ice Data Center (NSIDC)**, located at the University of Colorado in Boulder, maintains data sets comprised of Arctic sea ice concentration climatology derived from the **U.S. National Ice Center's (USNIC)** weekly or biweekly operational ice-chart time series. The charts used in the climatology are from 1972 through 2007; and the monthly climatology products are

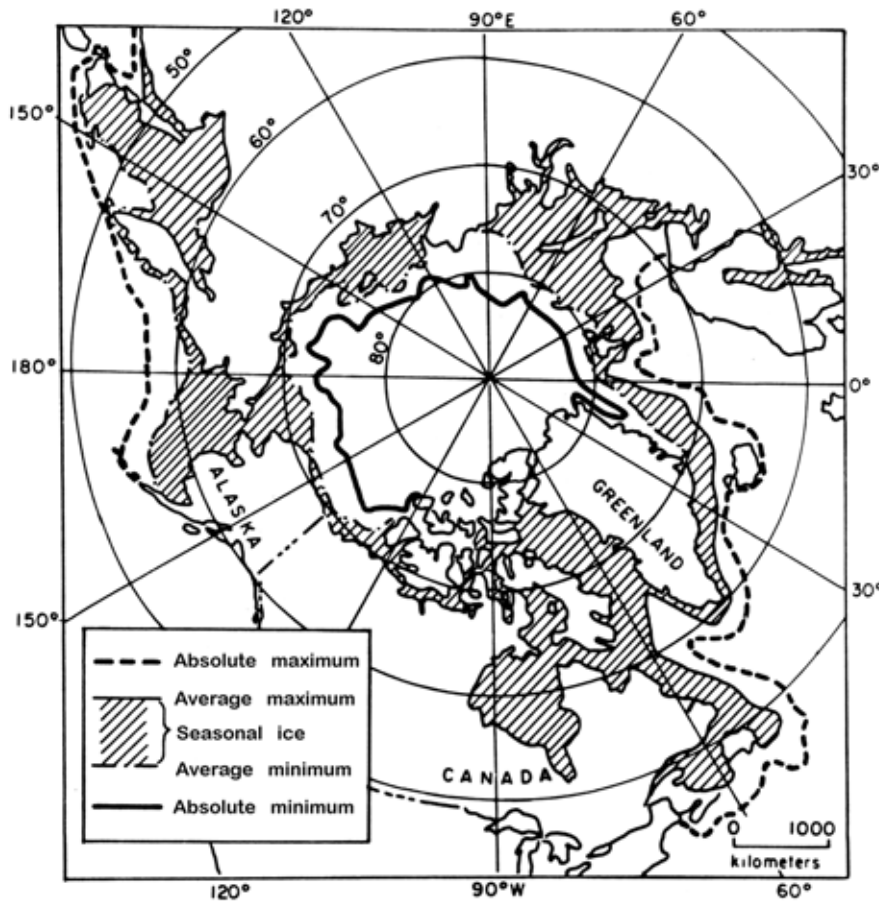

Figure 3210a. Average maximum and minimum extent of Arctic sea ice.

median, maximum, minimum, first quartile, and third quartile concentrations, as well as frequency of occurrence of ice at any concentration for the entire period of record as well as for 10-year and 5-year periods. These climatologies and the charts from which they are derived are provided in the 25-km Equal-Area Scalable Earth Grid (EASE-Grid) binary (.bin) format. The USNIC climatologies are also available in ArcGIS geodatabases (.mdb), and GIF format browse files (.gif) are also provided.

USNIC charts are produced through the analyses of available in situ, remote sensing, and model data sources. They are generated primarily for mission planning and safety of navigation. USNIC charts generally show more ice than do passive microwave derived sea ice concentrations, particularly in the summer when passive microwave algorithms tend to underestimate ice concentration. The record of sea ice concentration from the USNIC series is believed to be more accurate than that from passive microwave sensors, especially from the mid-1990s on, but it does not maintain the consistency of some passive microwave time series. NSIDC hosts numerous passive microwave and other sea ice data information useful to mariners planning voyages in or near areas affected by sea ice. These data sets are available through the link provided in Figure 3210d.

Daily sea ice edge analysis is available online via the link provided in Figure 3210e.

Additionally, the National Geospatial Agency's (NGA) **Arctic GEOINT Services portal** that includes nautical charts, sailing directions, shape files and infographics for the Arctic that allow the user to focus on specific data layers. The link is provided in Figure 3210f.

3211. Ice Detection

Safe navigation in ice infested waters depends on a number of factors, not the least of which is accurate knowledge of the location and amount of sea ice that lies between the mariner and his destination. Sophisticated electronic equipment, such as radar, sonar, and the visible, infrared, and microwave radiation sensors on board satellites, have added to our ability to detect and avoid ice.

Depending on the geographic location, as a ship proceeds into higher latitudes, the first ice encountered is likely to be in the form of icebergs, because such large pieces require a longer time to break up and melt. Icebergs can be avoided if detected early. The distance at which an iceberg can be seen visually depends upon meteorological visibility, height of the iceberg, source and condition of lighting, and

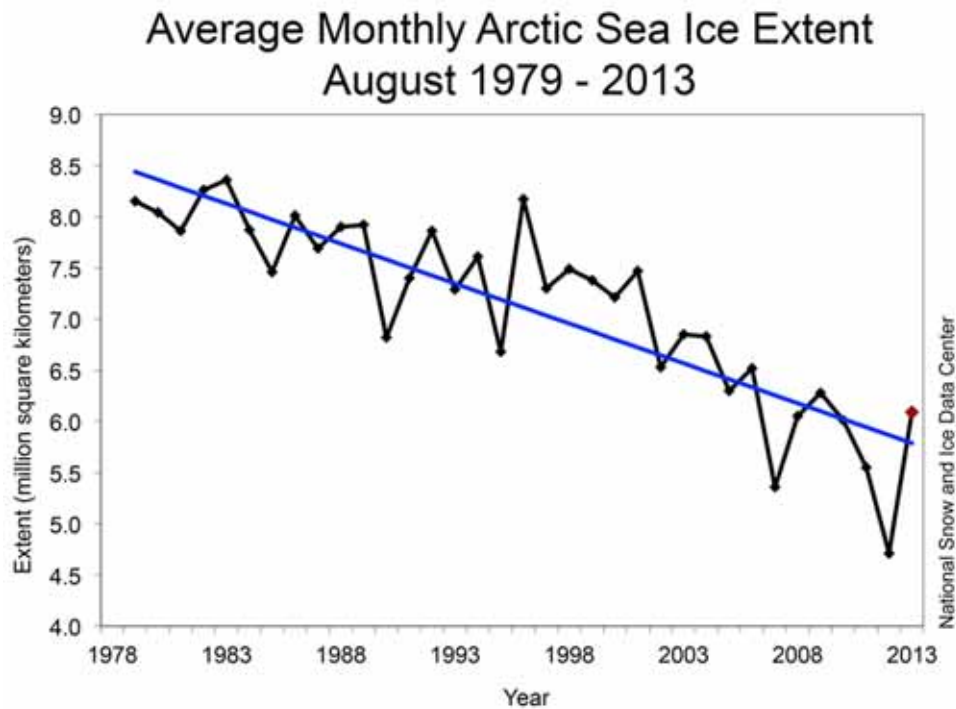

Figure 3210b. Average monthly Arctic sea ice extent August 1979 - 2013.

the observer. On a clear day with excellent visibility, a large iceberg might be sighted at a distance of 20 miles. With a low-lying haze around the horizon, this distance will be reduced. In light fog or drizzle this distance is further reduced, down to near zero in heavy fog.

In a dense fog an iceberg may not be perceptible until it is close aboard where it will appear in the form of a luminous, white object if the sun is shining; or as a dark, somber mass with a narrow streak of blackness at the waterline if the sun is not shining. If the layer of fog is not too thick, an iceberg may be sighted from aloft sooner than from a point lower on the vessel, but this does not justify omitting a bow lookout. The diffusion of light in a fog will produce a **blink**, or area of whiteness, above and at the sides of an iceberg which will appear to increase the apparent size of its mass.

On dark, clear nights icebergs may be seen at a distance of from 1 to 3 miles, appearing either as white or black objects with occasional light spots where waves break against it. Under such conditions of visibility, smaller growlers are more difficult to detect and pose a greater danger to vessels. The vessel's speed should be reduced and a sharp lookout maintained.

The moon may either help or hinder, depending upon its phase and position relative to ship and iceberg. A full moon in the direction of the iceberg interferes with its detection, while moonlight from behind the observer may produce a blink which renders the iceberg visible for a greater distance, as much as 3 or more miles. A clouded sky at night, through which the moonlight is intermittent, also renders ice

detection difficult. A night sky with heavy passing clouds may also dim or obscure any object which has been sighted, and fleecy cumulus and cumulonimbus clouds often may give the appearance of blink from icebergs.

If an iceberg is in the process of disintegration, its presence may be detected by a cracking sound as a piece breaks off, or by a thunderous roar as a large piece falls into the water. These sounds are unlikely to be heard due to shipboard noise. The appearance of small pieces of ice in the water often indicates the presence of an iceberg nearby. In calm weather these pieces may form a curved line with the parent iceberg on the concave side. Some of the pieces broken from an iceberg are themselves large enough to be a threat to shipping.

As the ship moves closer towards areas known to contain sea ice, one of the most reliable signs that pack ice is being approached is the absence of swell or wave motion in a fresh breeze or a sudden flattening of the sea, especially from leeward. The observation of icebergs is not a good indication that pack ice will be encountered soon, since icebergs may be found at great distances from pack ice. If the sea ice is approached from windward, it is usually compacted and the edge will be sharply defined. However, if it is approached from leeward, the ice is likely to be loose and somewhat scattered, often in long narrow arms.

Another reliable sign of the approach of pack ice not yet in sight is the appearance of a pattern, or **sky map**, on the horizon or on the underside of distant, extensive cloud areas, created by the varying amounts of light reflected

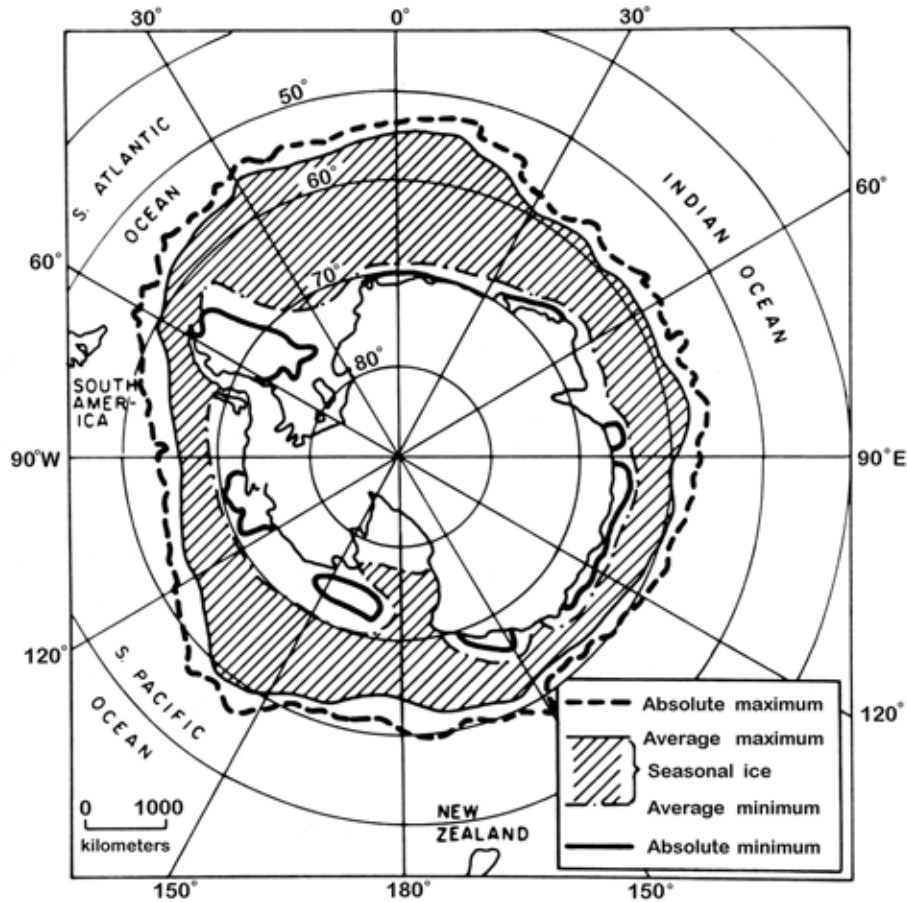

Figure 3210c. Average maximum and minimum extent of Antarctic sea ice.



Figure 3210d. U.S. National Snow and Ice Data Center.

<http://www.nsidc.org>



Figure 3210e. U.S. National Ice Center.

<https://www.natice.noaa.gov>

from different materials on the sea or Earth's surface. A bright white glare, or **snow blink**, will be observed above a snow covered surface. When the reflection on the underside of clouds is caused by an accumulation of distant ice, the glare is a little less bright and is referred to as an **ice blink**. A relatively dark pattern is reflected on the underside of clouds when it is over land that is not snow covered. This is

known as a land sky. The darkest pattern will occur when the clouds are above an open water area, and is called a **water sky**. A mariner experienced in recognizing these sky maps will find them useful in avoiding ice or searching out openings which may permit the vessel to make progress through an ice field.



Figure 3210f. NGA Arctic Support.
<http://nga.maps.arcgis.com/apps/MapSeries/index.html?appid=cf2fba21df7540fb981f8836f2a97e25>

Another indication of the presence of sea ice is the formation of thick bands of fog over the ice edge, as moisture condenses from warm air when passing over the colder ice. An abrupt change in air or sea temperature or seawater salinity is *not* a reliable sign of the approach of icebergs or pack ice.

The presence of certain species of animals and birds can also indicate that pack ice is in close proximity. The sighting of walrus, seals, or polar bears in the Arctic should warn the mariner that pack ice is close at hand. In the Antarctic, the usual precursors of sea ice are penguins, terns, fulmars, petrels, and skuas.

Due to the low profile and poor reflectivity, ice presents only about 1/60th of the radar return of a vessel of the same cross sectional area. It has a reflection coefficient of 0.33. Despite these limitations, a properly tuned radar can prove to be a valuable tool. Although many icebergs will be observed visually on clear days before there is a return on the radarscope, radar will detect the average iceberg at a range of about 8 to 10 miles.

The intensity of the return is a function of the nature of the ice's exposed surface (slope, surface roughness); however, it is unusual to find an iceberg which will not produce a detectable echo. Ice is not frequency-sensitive; both S- and X-band radars provide similar detectability. However, there is an advantage in using S-band radar in heavy precipitation since signal attenuation is less than X-band allowing better detection in these conditions.

While large icebergs will almost always be detected by radar in time to be avoided, a growler large enough to pose a serious danger to a vessel may be lost in the sea return and escape detection. Growlers cannot usually be detected at ranges greater than four miles, and are usually lost in seas greater than four feet. If an iceberg or growler is detected by radar, careful tracking is necessary to distinguish it from a rock, islet, or another ship.

Radar can be of great assistance to experienced radar observers. Smooth sea ice, like smooth water, returns little or no echo, but small floes of rough, hummocky sea ice capable of inflicting damage to a ship can be detected in a smooth sea at a range of about 2 to 4 miles. The return may be similar to sea return, but the same echoes appear at each sweep. A lead in smooth ice is clearly visible on a radarscope, even though a thin coating of new ice may have formed in the opening. A light covering of snow

obliterating many of the features to the eye will have little effect on radar return.

Experience in interpretation is gained through comparing various radar returns with actual observations. The most effective use of radar in ice detection and navigation is constant surveillance by trained and experienced operators.

Experience in interpretation is gained through comparing various radar returns with actual observations. The most effective use of radar in ice detection and navigation is constant surveillance by trained and experienced operators.

In lieu of other means of detections, echoes from the ship's whistle or horn may sometimes indicate the presence of icebergs and indicate direction. If the time interval between the sound and its echo is measured, the distance in meters can be determined by multiplying the number of seconds by 168. However, echoes are unreliable because only ice with a large vertical area facing the ship returns enough echo to be heard. Once an echo is heard, a distinct pattern of horn blasts (not a Navigational Rules signal) should be made to confirm that the echo is not another vessel.

Ice in the polar regions is best detected and observed from high above, either from aircraft or by satellite. Fixed-winged aircraft have been utilized extensively for obtaining detailed aerial ice reconnaissance information since the early 1930's. Some ships, particularly icebreakers, proceeding into high latitudes carry helicopters, which are invaluable in locating leads and determining the relative navigability of different portions of the ice pack. Unmanned aerial systems are also used for ice reconnaissance. Ice reports from personnel at Arctic and Antarctic coastal shore stations can also prove valuable to the polar mariner.

The enormous ice reconnaissance capabilities of meteorological satellites were confirmed within hours of the launch by the **National Aeronautics and Space Administration (NASA)** of the first experimental meteorological satellite, TIROS I, on April 1, 1960. With the advent of the polar-orbiting meteorological satellites during the mid and late 1960's, the U.S. Navy initiated an operational satellite ice reconnaissance program which could observe ice and its movement in any region of the globe on a daily basis, depending upon solar illumination. Since then, improvements in satellite sensor technology have provided a capability to make detailed global observations of ice properties under all weather and lighting conditions. The current suite of airborne and satellite sensors employed by the USNIC and the International Ice Patrol include: aerial reconnaissance using a real aperture maritime search radar with visual observations, visual and infrared satellite sensors, and all-weather passive microwave. In addition, **synthetic aperture radar (SAR)** on various commercial and government satellite platforms provide all-weather, day/night ice information for both sea ice and iceberg detection. Commercial SAR systems in use today include the Canadian Radarsat-2, the

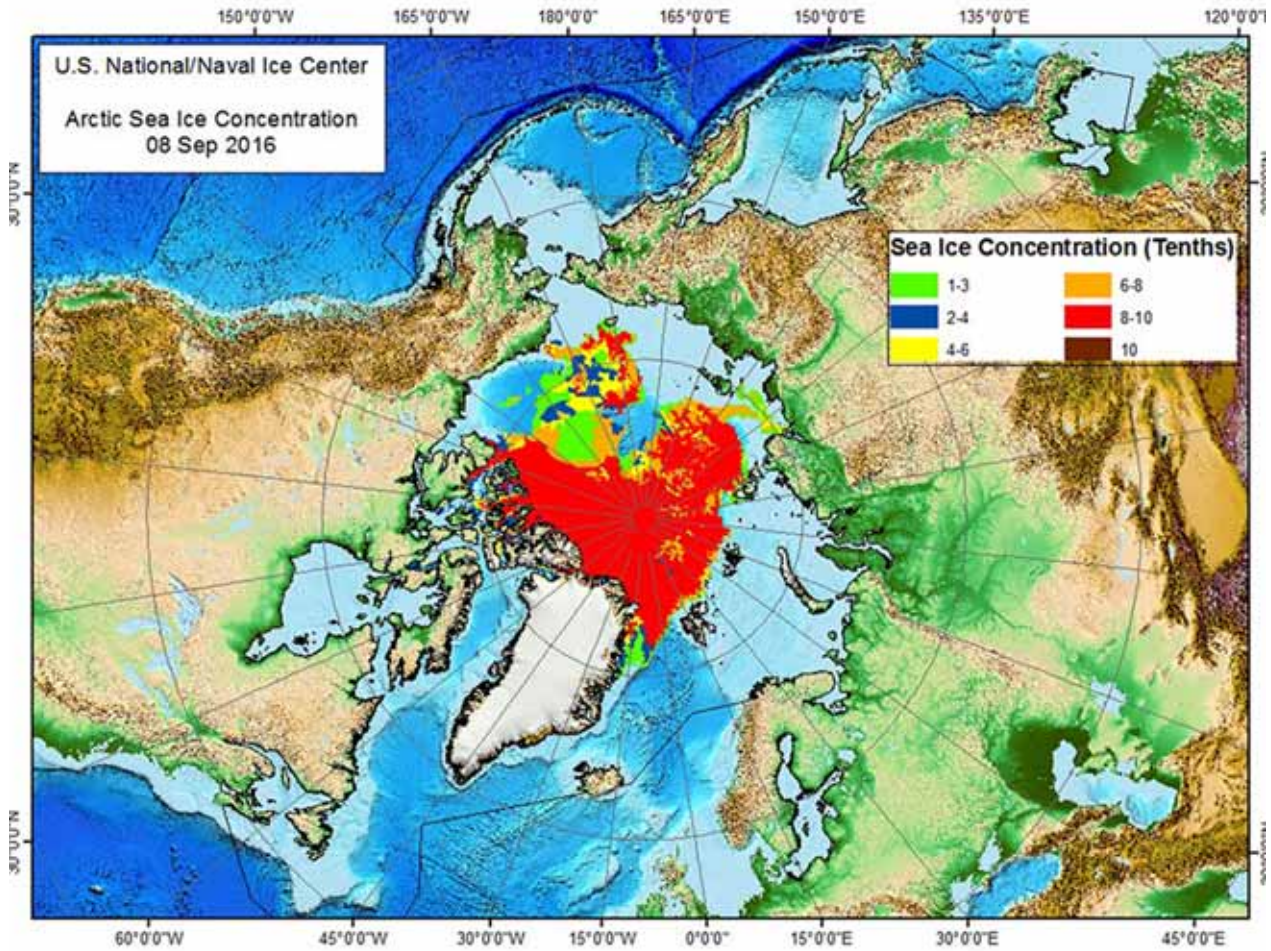

Figure 3211. Example of a USNIC Sea Ice Concentration Product derived from satellite imagery.

German TerraSAR-X, Italian COSMO-SkyMed, and the European Space Agency Sentinel-1 satellites. Operational ice services around the world have come to rely on SAR technology for ice monitoring and charting. A satellite-derived Sea Ice Concentration Product produced by the USNIC for 08 September 2016 is shown in Figure 3211.

3212. Operations in Ice

Operations in ice-prone regions necessarily require considerable advanced planning and many more precautionary measures than those taken prior to a typical open ocean voyage. The crew of a polar-bound vessel should be thoroughly indoctrinated in the fundamentals of polar operations, utilizing the best information sources available. The subjects covered should include training in ship handling in ice, polar navigation, effects of low temperatures on materials and equipment, damage control procedures, communications problems inherent in polar regions, polar meteorology, sea ice terminology, ice observing and reporting procedures (including classification and codes) and polar survival. Training materials

should consist of reports on previous Arctic and Antarctic voyages, sailing directions, ice atlases, training films on polar operations, and U.S. Navy service manuals detailing the recommended procedures to follow during high latitude missions.

The preparation of a vessel for polar operations is of extreme importance and the considerable experience gained from previous operations should be drawn upon to bring the ship to optimum operating condition. At the very least, operations conducted in ice-infested waters require that the vessel's hull and propulsion system undergo certain modifications.

The bow and waterline of the forward part of the vessel should be heavily reinforced. Similar reinforcement should also be considered for the propulsion spaces of the vessel. Cast iron propellers and those made of a bronze alloy do not possess the strength necessary to operate safely in ice. Therefore, it is strongly recommended that propellers made of these materials be replaced by steel. Other desirable features are the absence of vertical sides, deep placement of the propellers, a blunt bow, metal guards to protect propellers from ice damage, and lifeboats for 150 percent of

personnel aboard. The complete list of desirable features depends upon the area of operations, types of ice to be encountered, length of stay in the vicinity of ice, anticipated assistance by icebreakers, and possibly other factors. Strength requirements and the minimum thicknesses deemed necessary for the vessel's frames and additional plating to be used as reinforcement, as well as other procedures needed to outfit a vessel for ice operations, can be obtained from the American Bureau of Shipping. For a more definitive and complete guide to the ice strengthening of ships, the mariner may desire to consult the procedures outlined in Rules for Ice Strengthening of Ships, from the Board of Navigation, Helsinki, Finland. Further specifications have been published by the International Association of Classification Societies (IACS). These requirements are collectively known as **Polar Class**, and assess vessels from PC1 to PC5.

Equipment necessary to meet the basic needs of the crew and to insure the successful and safe completion of the polar voyage should not be overlooked. A minimum list of essential items should consist of polar clothing and footwear, 100% UV protective sunglasses, food, vitamins, medical supplies, fuel, storage batteries, antifreeze, explosives, detonators, fuses, meteorological supplies, and survival kits containing sleeping bags, trail rations, firearms, ammunition, fishing gear, emergency medical supplies, and a repair kit.

The vessel's safety depends largely upon the thoroughness of advance preparations, the alertness and skill of its crew, and their ability to make repairs if damage is incurred. Spare propellers, rudder assemblies, and patch materials, together with the equipment necessary to effect emergency repairs of structural damage should be carried. Examples of repair materials needed include quick setting cement, oakum, canvas, timbers, planks, pieces of steel of varying shapes, welding equipment, clamps, and an assortment of nuts, bolts, washers, screws, and nails.

Ice and snow accumulation on the vessel poses a definite capsizing hazard. Mallets, baseball bats, ax handles, and scrapers to aid in the removal of heavy accumulations of ice, together with snow shovels and stiff brooms for snow removal should be provided. A live steam line may be useful in removing ice from superstructures.

Navigation in polar waters is at best difficult and, during poor conditions, impossible, except using satellite or inertial systems. Environmental conditions encountered in high latitudes such as fog, storms, compass anomalies, atmospheric effects, and, of course, ice, hinder polar operations. Also, deficiencies in the reliability and detail of hydrographic and geographical information presented on polar navigation charts, coupled with a distinct lack of reliable bathymetry, current, and tidal data, add to the problems of polar navigation. Much work is being carried out in polar regions to improve the geodetic control, triangulation, and quality of hydrographic and topographic information necessary for accurate polar charts. However, until this massive task is completed, the only resource open

to the polar navigator, especially during periods of poor environmental conditions, is to rely upon the basic principles of navigation and adapt them to unconventional methods when abnormal situations arise.

Upon the approach to pack ice, a careful decision is needed to determine the best action. If it is possible to go around the ice, rather than through it, do so. Unless the pack is quite loose, this action usually gains rather than loses time. When skirting an ice field or an iceberg, do so to windward, if a choice is available, to avoid projecting tongues of ice or individual pieces that have been blown away from the main body of ice.

When it becomes necessary to enter pack ice, a thorough examination of the distribution and extent of the ice conditions should be made beforehand from the highest possible location. Aircraft (particularly helicopters) and direct satellite readouts are of great value in determining the nature of the ice to be encountered. The most important features to be noted include the location of open water, such as leads and polynyas, which may be manifested by water sky; icebergs; and the presence or absence of both ice under pressure and rotten ice. Some protection may be offered the propeller and rudder assemblies by trimming the vessel down by the stern slightly (not more than 2–3 feet) prior to entering the ice; however, this precaution usually impairs the maneuvering characteristics of most vessels not specifically built for ice breaking.

Selecting the point of entry into the pack should be done with great care; and if the ice boundary consists of closely packed ice or ice under pressure, it is advisable to skirt the edge until a more desirable point of entry is located. Seek areas with low ice concentrations, areas of rotten ice or those containing navigable leads, and if possible enter from leeward on a course perpendicular to the ice edge. It is also advisable to take into consideration the direction and force of the wind, and the set and drift of the prevailing currents when determining the point of entry and the course followed thereafter. Due to wind induced wave action, ice floes close to the periphery of the ice pack will take on a bouncing motion which can be quite hazardous to the hull of thin-skinned vessels. In addition, note that pack ice will drift slightly to the right of the true wind in the Northern Hemisphere and to the left in the Southern Hemisphere, and that leads opened by the force of the wind will appear perpendicular to the wind direction. If a suitable entry point cannot be located due to less than favorable conditions, patience may be called for. Unfavorable conditions generally improve over a short period of time by a change in the wind, tide, or sea state.

Once in the pack, always try to work with the ice, not against it, and keep moving, but do not rush. Respect the ice but do not fear it. Proceed at slow speed at first, staying in open water or in areas of weak ice if possible. The vessel's speed may be safely increased after it has been ascertained how well it handles under the varying ice conditions encountered. It is better to make good progress in the

general direction desired than to fight large thick floes in the exact direction to be made good. However, avoid the temptation to proceed far to one side of the intended track; it is almost always better to back out and seek a more penetrable area. During those situations when it becomes necessary to back, always do so with extreme caution and *with the rudder amidships*. If the ship is stopped by ice, the first command should be “rudder amidships,” given while the screw is still turning. This will help protect the propeller when backing and prevent ice jamming between rudder and hull. If the rudder becomes ice-jammed, man after steering, establish communications, and *do not* give any helm commands until the rudder is clear. A quick full-ahead burst may clear it. If it does not, try going to “hard rudder” *in the same direction slowly* while turning full or flank speed ahead.

Ice conditions may change rapidly while a vessel is working in pack ice, necessitating quick maneuvering. Conventional vessels, even if ice strengthened, are not built for icebreaking. The vessel should be conned to first attempt to place it in leads or polynyas, giving due consideration to wind conditions. The age, thickness, and size of ice which can be navigated depends upon the type, size, hull strength, and horsepower of the vessel employed. If contact with an ice floe is unavoidable, never strike it a glancing blow. This maneuver engages the ice with weaker parts of the hull, and may cause the ship to veer off in a direction which will swing the stern into the ice. If possible, seek weak spots in the floe and engage it head-on at slow speed. Unless the ice is rotten or very young, do not attempt to break through the floe, but rather make an attempt to swing it aside as speed is slowly increased. Keep clear of corners and projecting points of ice, but do so without making sharp turns which may throw the stern against the ice, resulting in a damaged propeller, propeller shaft, or rudder. The use of full rudder in non-emergency situations is not recommended because it may swing either the stern or mid-section of the vessel into the ice. This does not preclude use of alternating full rudder (**sallying** the rudder) aboard icebreakers as a technique for penetrating heavy ice.

Offshore winds may open relatively ice free navigable coastal leads, but such leads should not be entered without benefit of icebreaker escort. If it becomes necessary to enter coastal leads, narrow straits, or bays, an alert watch should be maintained since a shift in the wind may force drifting ice down upon the vessel. An increase in wind on the windward side of a prominent point, grounded iceberg, or land ice tongue extending into the sea will also endanger a vessel. It is wiser to seek out leads toward the windward side of the main body of the ice pack. In the event that the vessel is under imminent danger of being trapped close to shore by pack ice, immediately attempt to orient the vessel's bow seaward. This will help to take advantage of the little maneuvering room available in the open water areas found between ice floes. Work carefully through these areas, easing the ice floes aside

while maintaining a close watch on the general movement of the ice pack.

If the vessel is completely halted by pack ice, it is best to keep the rudder amidships, and the propellers turning at slow speed. The wash of the propellers will help to clear ice away from the stern, making it possible to back down safely. When the vessel is stuck fast, an attempt first should be made to free the vessel by going full speed astern. If this maneuver proves ineffective, it may be possible to get the vessel's stern to move slightly, thereby causing the bow to shift, by quickly shifting the rudder from one side to the other while going full speed ahead. Another attempt at going astern might then free the vessel. The vessel may also be freed by either transferring water from ballast tanks, causing the vessel to list, or by alternately flooding and emptying the fore and aft tanks. A heavy weight swung out on the cargo boom might give the vessel enough list to break free. If all these methods fail, the utilization of deadmen (2- to 4-meter lengths of timber buried in holes out in the ice and to which a vessel is moored) and ice anchors (a stockless, single fluked hook embedded in the ice) may be helpful. With a deadman or ice anchors attached to the ice astern, the vessel may be warped off the ice by winching while the engines are going full astern. If all the foregoing methods fail, explosives placed in holes cut nearly to the bottom of the ice approximately 10 to 12 meters off the beam of the vessel and detonated while the engines are working full astern might succeed in freeing the vessel. A vessel may also be sawed out of the ice if the air temperature is above the freezing point of seawater.

When a vessel becomes so closely surrounded by ice that all steering control is lost and it is unable to move, it is **beset**. It may then be carried by the drifting pack into shallow water or areas containing thicker ice or icebergs with their accompanying dangerous underwater projections. If ice forcibly presses itself against the hull, the vessel is said to be **nipped**, whether or not damage is sustained. When this occurs, the gradually increasing pressure may be capable of holing the vessel's bottom or crushing the sides. When a vessel is beset or nipped, freedom may be achieved through the careful maneuvering procedures, the physical efforts of the crew, or by the use of explosives similar to those previously detailed. Under severe conditions the mariner's best ally may be patience since there will be many times when nothing can be done to improve the vessel's plight until there is a change in meteorological conditions. It may be well to preserve fuel and perform any needed repairs to the vessel and its engines. Damage to the vessel while it is beset is usually attributable to collisions or pressure exerted between the vessel's hull, propellers, or rudder assembly, and the sharp corners of ice floes. These collisions can be minimized greatly by attempting to align the vessel in such a manner as to insure that the pressure from the surrounding pack ice is distributed as evenly as possible over the hull. This is best accomplished when medium or large ice floes encircle the vessel.

In the vicinity of icebergs, either in or outside of the

pack ice, a sharp lookout should be kept and all icebergs given a wide berth. The commanding officers and masters of all vessels, irrespective of their size, should treat all icebergs with great respect. The best locations for lookouts are generally in a crow's nest, rigged in the foremast or housed in a shelter built specifically for a bow lookout in the eyes of a vessel. Telephone communications between these sites and the navigation bridge on larger vessels will prove invaluable. It is dangerous to approach close to an iceberg of any size because of the possibility of encountering underwater extensions, and because icebergs that are disintegrating may suddenly capsize or readjust their masses to new positions of equilibrium. In periods of low visibility the utmost caution is needed at all times. Vessel speed should be reduced and the watch prepared for quick maneuvering. Radar becomes an effective but not infallible tool, and does not negate the need for trained lookouts.

Since icebergs may have from eight to nine-tenths of their masses below the water surface, their drift is generally influenced more by currents than winds, particularly under light wind conditions. The drift of pack ice, on the other hand, is usually dependent upon the wind. Under these conditions, icebergs within the pack may be found moving at a different rate and in a different direction from that of the pack ice. In regions of strong currents, icebergs should always be given a wide berth because they may travel upwind under the influence of contrary currents, breaking heavy pack in their paths and endangering vessels unable to work clear. In these situations, open water will generally be found to leeward of the iceberg, with piled up pack ice to windward. Where currents are weak and a strong wind predominates, similar conditions will be observed as the wind driven ice pack overtakes an iceberg and piles up to windward with an open water area lying to leeward.

Under ice, submarine operations require knowledge of prevailing and expected sea ice conditions to ensure maximum operational efficiency and safety. The most important ice features are the frequency and extent of downward projections (bommocks and ice keels) from the underside of the ice canopy (pack ice and enclosed water areas from the point of view of the submariner), the distribution of thin ice areas through which submarines can attempt to surface, and the probable location of the outer pack edge where submarines can remain surfaced during emergencies to rendezvous with surface ship or helicopter units.

Bommocks are the subsurface counterpart of hummocks, and **ice keels** are similarly related to ridges. When the physical nature of these ice features is considered, it is apparent that ice keels may have considerable horizontal extent, whereas individual bommocks can be expected to have little horizontal extent. In shallow water lanes to the Arctic Basin, such as the Bering Strait and the adjoining portions of the Bering Sea and Chukchi Sea, deep bommocks and ice keels may leave little vertical room for submarine passage. Widely

separated bommocks may be circumnavigated but make for a hazardous passage. Extensive ice areas, with numerous bommocks or ice keels which cross the lane may effectively block both surface and submarine passage into the Arctic Basin.

Bommocks and ice keels may extend downward approximately five times their vertical extent above the ice surface. Therefore, observed ridges of approximately 10 meters may extend as much as 50 meters below sea level. Because of the direct relation of the frequency and vertical extent between these surface features and their subsurface counterparts, aircraft ice reconnaissance should be conducted over a planned submarine cruise track before under ice operations commence.

Skylights are thin places (usually less than 1 meter thick) in the ice canopy, and appear from below as relatively light translucent patches in dark surroundings. The undersurface of a skylight is usually flat; not having been subjected to great pressure. Skylights are called large if big enough for a submarine to attempt to surface through them; that is, have a linear extent of at least 120 meters. Skylights smaller than 120 meters are referred to as small. An ice canopy along a submarine's track that contains a number of large skylights or other features such as leads and polynyas, which permit a submarine to surface more frequently than 10 times in 30 miles, is called **friendly ice**. An ice canopy containing no large skylights or other features which permit a submarine to surface is called **hostile ice**.

3213. Great Lakes Ice

Large vessels have been navigating the Great Lakes since the early 1760's. This large expanse of navigable water has since become one of the world's busiest waterways. Due to the northern geographical location of the Great Lakes Basin and its susceptibility to Arctic outbreaks of polar air during winter, the formation of ice plays a major disruptive role in the region's economically vital marine industry. Because of the relatively large size of the five Great Lakes, the ice cover which forms on them is affected by the wind and currents to a greater degree than on smaller lakes. The Great Lakes' northern location results in a long ice growth season, which in combination with the effect of wind and current, imparts to their ice covers some of the characteristics and behavior of an Arctic ice pack.

Since the five Great Lakes extend over a distance of approximately 800 kilometers in a north-south direction, each lake is influenced differently by various meteorological phenomena. These, in combination with the fact that each lake also possesses different geographical characteristics, affect the extent and distribution of their ice covers.

The largest, deepest, and most northern of the Great Lakes is **Lake Superior**. Initial ice formation normally begins at the end of November or early December in harbors and bays along the north shore, in the western portion of the

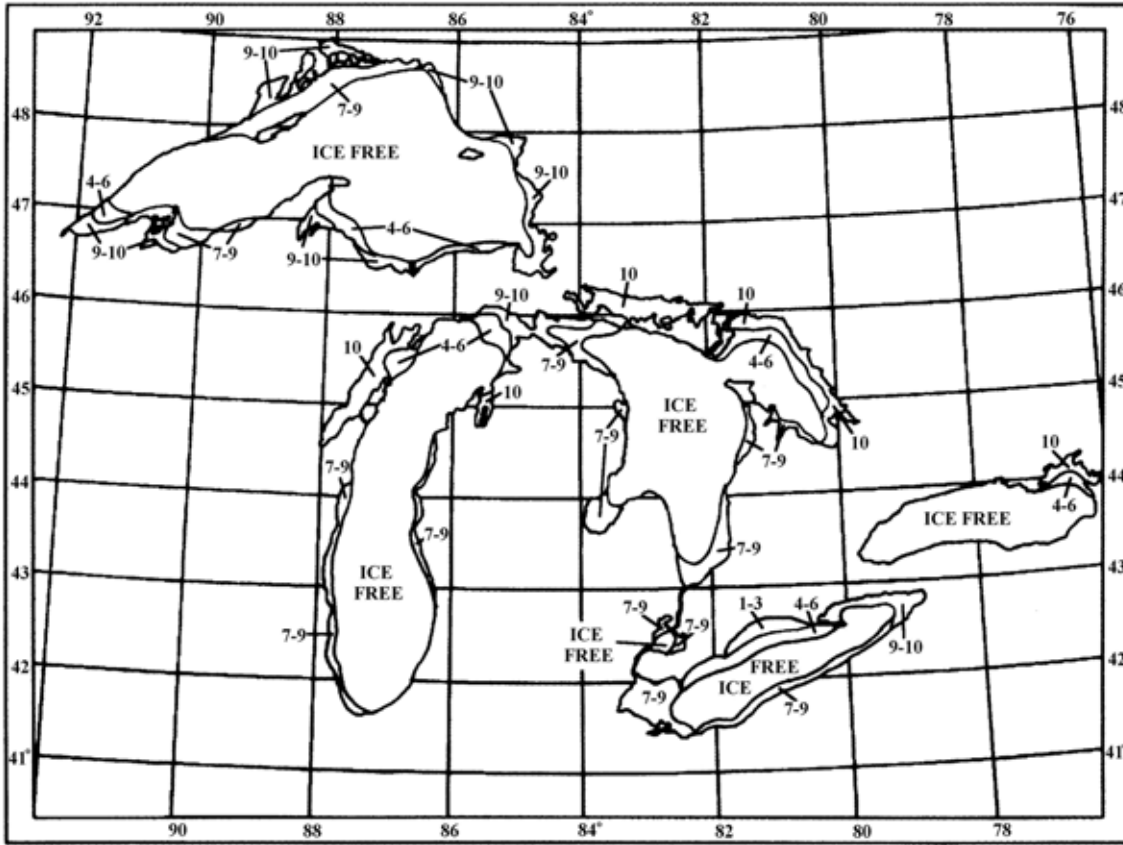

Figure 3213a. Great Lakes ice cover during a mild winter.



Figure 3213b. USCG cutters KATMAI BAY and MORRO BAY hold position as ice breaker MACKINAW works to find open water leads out of Whitefish Bay, Lake Superior, March 21-23, 2014. Credit: USCG Soo.

lake and over the shallow waters of Whitefish Bay (see Figure 3213b). As the season progresses, ice forms and thickens in all coastal areas of the lake perimeter prior to extending offshore. This formation pattern can be attributed to a maximum depth in excess of 400 meters and an associated large heat storage capacity that hinders early ice formation in the center of the lake. During a normal winter, ice not under pressure ranges in thickness from 45–85 centimeters. During severe winters, maximum thicknesses are reported to approach 100 centimeters. Winds and currents acting upon the ice have been known to cause ridging with heights approaching 10 meters. During normal years, maximum ice

cover extends over approximately 75% of the lake surface with heaviest ice conditions occurring by early March. This value increases to 95% coverage during severe winters and decreases to less than 20% coverage during a mild winter. Winter navigation is most difficult in the southeastern portion of the lake due to heavy ridging and compression of the ice under the influence of prevailing westerly winds. Break-up normally starts near the end of March with ice in a state of advanced deterioration by the middle of April. Under normal conditions, most of the lake is ice-free by the first week of May.

Lake Michigan extends in a north-south direction over

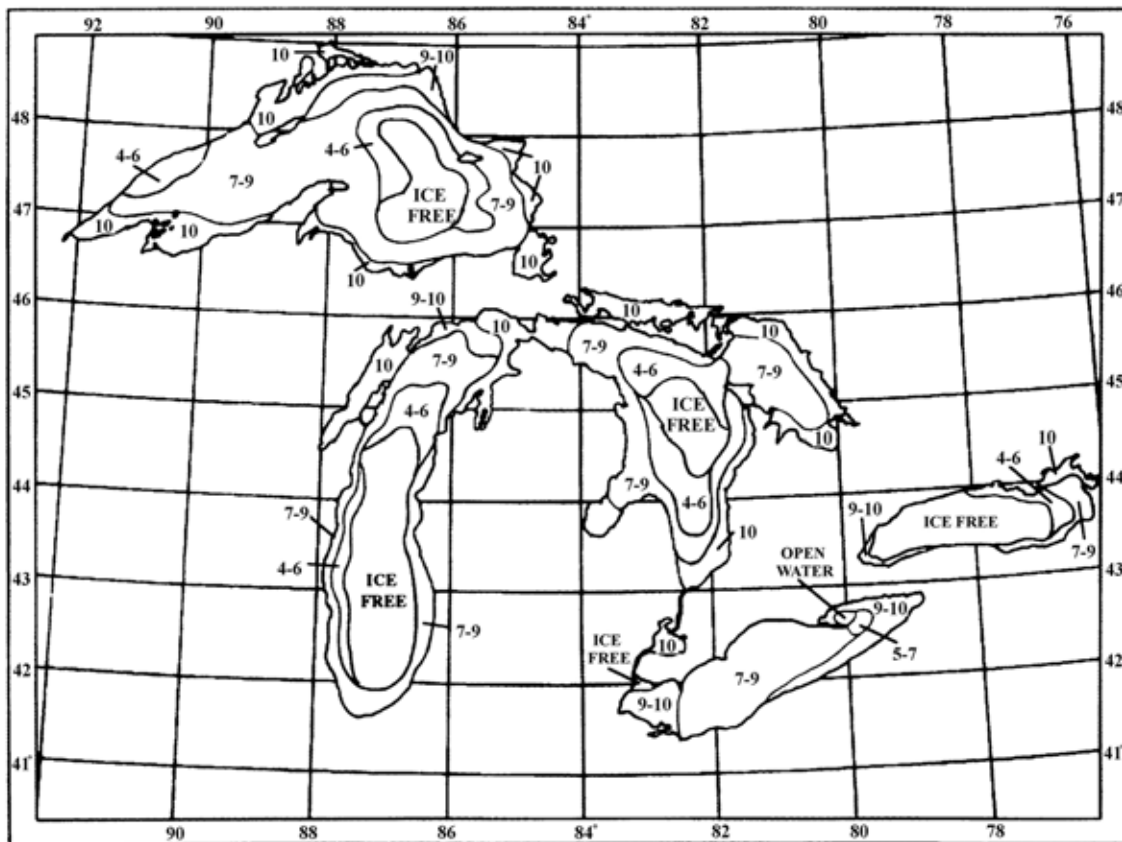

Figure 3213c. Great Lakes ice cover during a normal winter.

490 kilometers and possesses the third largest surface area of the five Great Lakes. Depths range from 280 meters in the center of the lake to 40 meters in the shipping lanes through the Straits of Mackinac, and less in passages between island groups. During average years, ice formation first occurs in the shallows of Green Bay and extends eastward along the northern coastal areas into the Straits of Mackinac during the second half of December and early January. Ice formation and accumulation proceeds southward with coastal ice found throughout the southern perimeter of the lake by late January. Normal ice thicknesses range from 10–20 centimeters in the south to 40–60 centimeters in the north. During normal years, maximum

ice cover extends over approximately 40% of the lake surface with heaviest conditions occurring in late February and early March. Ice coverage increases to 85–90% during a severe winter and decreases to only 10–15% during a mild year. Coverage of 100% occurs, but rarely. Throughout the winter, ice formed in mid-lake areas tends to drift eastward because of prevailing westerly winds. This movement of ice causes an area in the southern central portion of the lake to remain ice-free throughout a normal winter. Extensive ridging of ice around the island areas adjacent to the Straits of Mackinac presents the greatest hazard to year-round navigation on this lake. Due to an extensive length and north-south orientation, ice formation and deterioration often oc-

cur simultaneously in separate regions of this lake. Ice break-up normally begins by early March in southern areas and progresses to the north by early April. Under normal conditions, only 5–10% of the lake surface is ice covered by mid-April with lingering ice in Green Bay and the Straits of Mackinac completely melting by the end of April.

Lake Huron, the second largest of the Great Lakes, has maximum depths of 230 meters in the central basin west of the Bruce peninsula and 170 meters in Georgian Bay. The pattern of ice formation in Lake Huron is similar to the north-south progression described in Lake Michigan. Initial ice formation normally begins in the North Channel and along the eastern coast of Saginaw and Georgian Bays by mid-December. Ice rapidly expands into the western and southern coastal areas before extending out into the deeper portions of the lake by late January. Normal ice thicknesses are 45–75 centimeters. During severe winters, maximum ice thicknesses often exceed 100 centimeters with wind-

rows of ridged ice achieving thicknesses of up to 10 meters. During normal years, maximum ice cover occurs in late February with 60% coverage in Lake Huron and nearly 95% coverage in Georgian Bay. These values increase to 85–90% in Lake Huron and nearly 100% in Georgian Bay during severe winters. The percent of lake surface area covered by ice decreases to 20–25% for both bodies of water during mild years. During the winter, ice as a hazard to navigation is of greatest concern in the St. Mary's River/North Channel area and the Straits of Mackinac. Ice break-up normally begins in mid-March in southern coastal areas with melting conditions rapidly spreading northward by early April. A recurring threat to navigation is the southward drift and accumulation of melting ice at the entrance of the St. Clair river. Under normal conditions, the lake becomes ice free by the first week of May.

The shallowest and most southern of the Great Lakes is

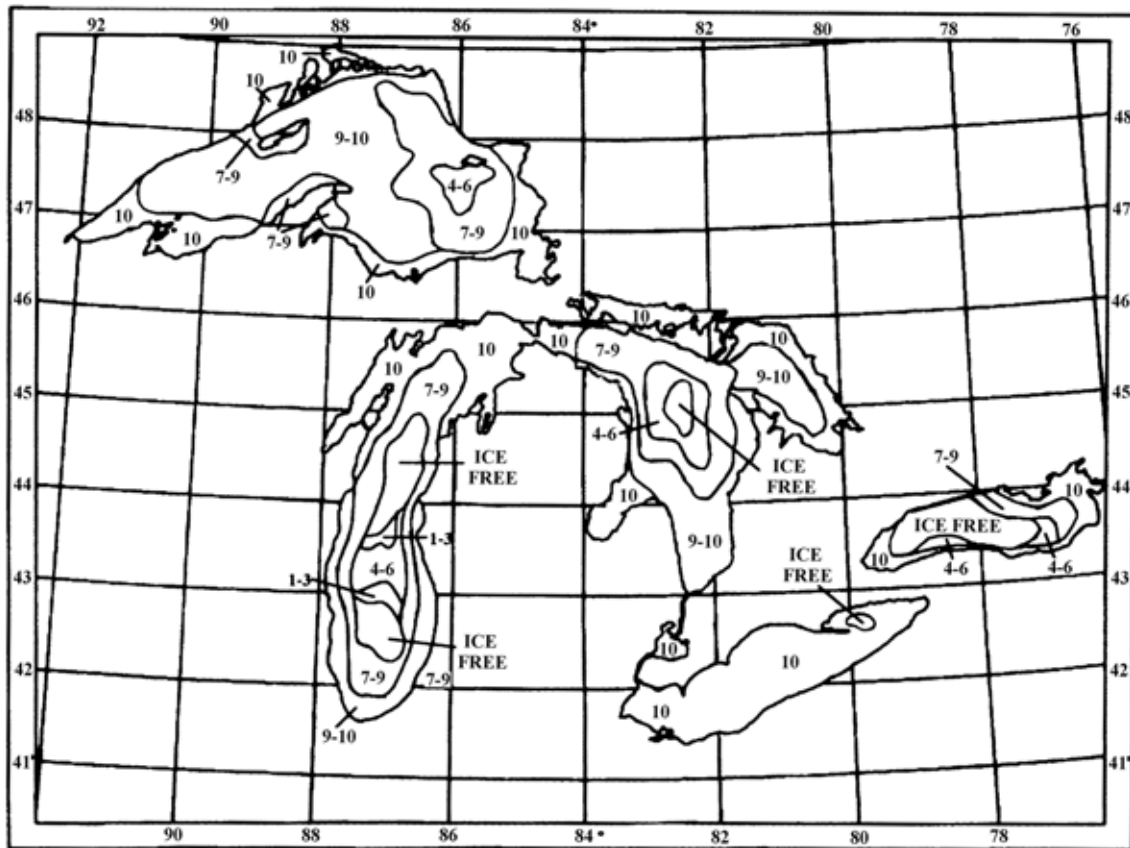

Figure 3213d. Great Lakes ice cover during a severe winter.

Lake Erie. Although the maximum depth nears 65 meters in the eastern portion of the lake, an overall mean depth of only 20 meters results in the rapid accumulation of ice over a short period of time with the onset of winter. Initial ice formation begins in the very shallow western portion of the lake in mid-December with ice rapidly extending eastward by early January. The eastern portion of the lake does not normally become ice covered until late January. During a

normal winter, ice thicknesses range from 25–45 centimeters in Lake Erie. During the period of rapid ice growth, prevailing winds and currents routinely move existing ice to the northeastern end of the lake. This accumulation of ice under pressure is often characterized by ridging with maximum heights of 8–10 meters. During a severe winter, initial ice formation may begin in late November with maximum seasonal ice thicknesses exceeding 70 centimeters. Since

this lake reacts rapidly to changes in air temperature, the variability of percent ice cover is the greatest of the five Great Lakes. During normal years, ice cover extends over approximately 90–95% of the lake surface by mid to late February. This value increases to nearly 100% during a severe winter and decreases to 30% ice coverage during a mild year. Lake St. Clair, on the connecting waterway to Lake Huron, is normally consolidated from the middle of January until early March. Ice break-up normally begins in the western portion of Lake Erie in early March with the lake becoming mostly ice-free by the middle of the month. The exception to this rapid deterioration is the extreme eastern end of the lake where ice often lingers until early May.

Lake Ontario has the smallest surface area and second greatest mean depth of the Great Lakes. Depths range from 245 meters in the southeastern portion of the lake to 55 meters in the approaches to the St. Lawrence River. Like Lake Superior, a large mean depth gives Lake Ontario a large heat storage capacity which, in combination with a small surface area, causes Lake Ontario to respond slowly to changing meteorological conditions. As a result, this lake produces the smallest amount of ice cover found on any of the Great Lakes. Initial ice formation normally begins from the middle to late December in the Bay of Quinte and extends to the western coastal shallows near the mouth of the St. Lawrence River by early January. By the first half of February, Lake Ontario is almost 20% ice covered with shore ice lining the perimeter of the lake. During normal years, ice cover extends over approximately 25% of the lake's surface by the second half of February. During this period of maximum ice coverage, ice is typically concentrated in the northeastern portion of the lake by prevailing westerly winds and currents. Ice coverage can extend over 50–60% of the lake surface during a severe winter and less than 10% during a mild year. Level lake ice thicknesses

normally fall within the 20–60 centimeter range with occasional reports exceeding 70 centimeters during severe years. Ice break-up normally begins in early March with the lake generally becoming ice-free by mid-April.

The maximum ice cover distribution attained by each of the Great lakes for mild, normal and severe winters is shown in Figure 3213a, Figure 3213c and Figure 3213d. It should be noted that although the average maximum ice cover for each lake appears on the same chart, the actual occurrence of each distribution takes place during the time periods described within the preceding narratives.

Analysis of the Great Lakes ice is done at the USNIC in conjunction with the Canadian Ice Service. This partnership - the North American Ice Service provides daily analysis of the Great Lakes ice throughout the season. Near real time lake ice products are publicly available at www.natice.noaa.gov. Additional information is available to the mariner from NOAA's **Great Lakes Environmental Research Laboratory (GLERL)** via the link provided in Figure 3213e.



Figure 3213e. NOAA - Great Lakes Environmental Research Laboratory. <https://www.glerl.noaa.gov/>

ICE INFORMATION SERVICES

3214. Importance of Ice Information

Advance knowledge of ice conditions to be encountered and how these conditions will change over specified time periods are invaluable for both the planning and operational phases of a voyage to the polar regions. Branches of the United States Federal Government responsible for providing operational ice products and services for safety of navigation include the Departments of Defense (U.S. Navy), Commerce (NOAA), and Homeland Security (U.S. Coast Guard). All of these agencies are part of the joint **U.S. National Ice Center (USNIC)**. The USNIC provides ice products and services to U.S. Government and maintains a public website for general ice conditions in the Arctic, Antarctic and Great Lakes. USNIC charts are produced through the analyses of available, near real time remote sensing, and model data sources. They are generated primarily for maritime domain awareness, and for U.S. government mission

planning and safety of navigation. The content of sea ice analyses is directly dependent upon the planned use of the product, the required level of detail, and the availability of on-site ice observations and/or remotely-sensed data. Ice analyses are produced primarily from satellite remote sensing data. Information from ship observations, aircraft reconnaissance, and buoy data are used when available.

The accurate interpretation of these data is critical to producing the USNIC's daily sea ice edge and the weekly Arctic and Antarctic hemispheric sea ice charts. Great Lakes ice analysis are done through the ice season; December through May.

3215. Ice Forecasts and Observations

Ice forecasting services are provided to U.S. Government agencies upon request for ongoing polar operations and operational planning. For government

entities, optimum track ship routing (OTSR) recommendations via the USN's Fleet Weather Center in Norfolk, VA will include sea ice edge information as applicable. Government units can request support via the USNIC website or by contacting the Command Duty Officer. Commercial operations interested in ice products may obtain routinely produced ice products from the public USNIC website and, in U.S. Alaska waters, from the **Alaska Sea Ice Program (ASIP)** sea ice desk in Anchorage, Alaska. They provide support to government and public users. Their products are available via the link provided in Figure 3215a.

The U.S. Coast Guard has an additional responsibility, separate from the USNIC, for providing icebreaker support for polar operations and the administration and operations of the **International Ice Patrol (IIP)**.



Figure 3215a Alaska Sea Ice Program.
<https://www.weather.gov/afc/ice>

Ice observation codes make use of special nomenclature which is precisely defined in several languages by the WMO publication *Sea Ice Nomenclature - WMO No. 259, TP 145*. This publication, available from the Secretariat of the WMO, contains descriptive definitions along with photography of most ice features. This publication is very useful for vessels planning to submit ice observations. The



Figure 3215b. The Sea-Ice Nomenclature. http://www.ioc-unesco.org/index.php?option=com_oe&task=viewdocumentrecord&docid=14598

publication is available online via the link provided in Figure 3215b.

3216. The North Atlantic Ice Patrol

The North Atlantic Ice Patrol was established in 1914 by the International Convention for the Safety of Life at Sea (SOLAS), held in 1913 as a result of the sinking of the RMS TITANIC in 1912. The TITANIC struck an iceberg on its maiden voyage and sank with the loss of 1,513 lives. In accordance with the agreement reached at the SOLAS conventions of 1960 and 1974, the U.S. Coast Guard International Ice Patrol monitors the iceberg danger in the North Atlantic Ocean and to provide relevant iceberg warning products to the maritime community. Information on ice conditions for the Gulf of St. Lawrence and the coastal waters of Newfoundland and Labrador, including the Strait of Belle Isle, is provided by **ECAREG Canada** (Eastern Canada Traffic System), through any Coast Guard Radio Station, from the month of December through late June. Sea ice data for these areas can also be obtained from the Ice Operations Officer, located at St. Johns, Newfoundland, via Sydney, Halifax, or St. John's marine radio. The ice operations desk can be contacted at: iceatl.cgge@dfo-mpo.cg.ca

During the war years of 1916-18 and 1941-45, the Ice Patrol was suspended. Aircraft were added to the patrol force following World War II, and today perform the majority of the reconnaissance work. During each ice season, aerial reconnaissance surveys are made in the vicinity of the Grand Banks of Newfoundland and along the coast of Labrador to determine the southern, eastern, and western limit of the seaward extent of icebergs. The U.S. Coast Guard aircraft use the 360-degree ELTA radar to help detect and identify icebergs in this notoriously fog-ridden area. Reports of ice sightings are also requested and collected from ships transiting the Ice Patrol's operational area. Vessels are encouraged to report sightings of icebergs or stationary radar targets that may likely be icebergs to the nearest **Canadian Coast Guard Marine Communications and Traffic Services (MCTS)** station or the International Ice Patrol at: iipcomms@uscg.mil. Ice reports may also be sent at no charge using INMARSAT Code 42. The IIP implements a voluntary ice observation reporting system called the **Vessel of Opportunity Observation Program (VOOP)**. More information on the VOOP can be found at: <http://www.navcen.uscg.gov/pdf/iip/VOOP.pdf>.

International Ice Patrol activities are directed from an Operations Center in New London, Connecticut. The Ice Patrol gathers iceberg reports from all sources, including its own reconnaissance flights, commercial reconnaissance flights, and ships at sea and incorporates them into a computer database. An iceberg drift and deterioration model is then used to analyze and predict the movement and melt of the icebergs. Due to the large size of the Ice Patrol's operating area, some icebergs are seen only once. Model predictions are used to create iceberg warning products.

The results from the iceberg drift and deterioration model are used to compile bulletins that are issued once daily at

0000Z by radio communications. Bulletins are available over INMARSAT as a NAVAREA IV navigational warning. A bulletin and iceberg chart can also be found on the USCG Navigation Center webs portal via the link provided in Figure 3216.



Figure 3216. Products produced by the North American Ice Service (an international partnership between the International Ice Patrol, Canadian Ice Service and the National Ice Center) can be found via the following link: <http://www.navcen.uscg.gov/?pageName=iipProducts>

When icebergs are sighted outside the Iceberg Limit, **Notices to Shipping (NOTSHIP)** are issued by MCTS St. John's in between the regularly scheduled bulletins. Iceberg positions in the ice bulletins are updated for drift and deterioration at 12- hour intervals. A radio-facsimile chart is also broadcast once a day throughout the ice season.

A summary of broadcast times and frequencies can be found in Pub. 117, Radio Navigational Aids, and on the International Ice Patrol web site at: <http://www.navcen.uscg.gov/?pageName=IIPHome>.

Ice Patrol formed a partnership with the **Canadian Ice Service (CIS)** and the USNIC as the **North American Ice Service (NAIS)** with a goal to be the leading authority in ice information and services for the maritime interests of the Canadian and United States Governments in North America. IIP and CIS share a joint database of icebergs in the North Atlantic. Each organization produces the NAIS Iceberg Warning products at different times of the year. IIP is responsible for the products from January through September when icebergs typically threaten the transatlantic shipping lanes while CIS is responsible for the products during the remainder of the year when icebergs normally only threaten Canadian coastal waters. Both an English and a French version of the NAIS iceberg chart can be found on the CIS website at <http://iceweb1.cis.ec.gc.ca/Prod/page2.xhtml?CanID=11091&lang=en&title=East+Coast>.

3217. Ice Navigation in Canadian Waters

Ice Navigation in Canadian Waters is published by the Canadian Coast Guard and is intended to assist ships operating in ice in all Canadian waters, including the Arctic. This outstanding publication is available for free online through the link provided in Figure 3217 and provides vessels transiting Canadian ice-covered waters with the necessary understanding of the regulations, shipping support services, hazards and navigation techniques in ice.



Figure 3217 *Ice Navigation in Canadian Waters*. <http://www.ccg-gcc.gc.ca/folios/00913/docs/ice-navigation-dans-les-galces-eng.pdf>

3218. International Ice Information

The International Ice Charting Working Group (IICWG) was formed in October 1999 to promote cooperation between the world's ice centers on all matters concerning sea ice and icebergs. Members of this group are the world's experts in observing ice from satellites and aircraft, modeling ice, and preparing ice warning products for mariners to promote safe navigation. The group is dedicated to staying on top of emerging technologies in sea ice and iceberg detection by all means. Members share information on these technologies to benefit the ice services and mariners worldwide.

Contacting the ice services of the IICWG for accurate ice information will directly contribute to the protection of the marine environment by assisting with planning response efforts in the vicinity of the ice. The contact information, working hours, and internet addresses for each of the ice services, both in the Northern and Southern Hemispheres, are provided below.

International Ice Service Emergency Response Numbers

Argentina: <http://www.hidro.gov.ar>

Meteorology Department

Naval Hydrographic Service

Address: Av. Montes de Oca 2124 - Ciudad Autónoma de Buenos Aires. República Argentina. P.O. Box C1270AVB

Phone: (+54) 11 4317 2534 Spanish-speaking only

Hours: 24/7

E-mail: hydrosn@gov.ar

Australia: <http://www.bom.gov.au/ant>

Bureau of Meteorology Tasmania/Antarctica Region

Address: AACECRC Privatebag 80, HOBART Australia 7001

Phone: +61-3-62323642

Alternate Phone: +61-3-62323113

Hours: 24/7, Leave a message if no one answers, and response will be made within the hour

E-mail: season.ops@aad.gov.au, jan.lieser@acecrc.org.au
Neal.young@acecrc.org.au

Brazil:

<https://www.mar.mil.br/dhn/chm/meteo/indexing.htm>

Navy Hydrography Center-Marine Meteorological Service

Address: Rua Barão de Jaceguay, s/n Ponta da Armação Niterói, RJ CEP. 24048-900

Phone: (+55) 21 2189-3275

Hours: 0830L-1630L, Monday thru Friday

Best Contact Number: (+55) 21 893-270, Available 24/7

E-mail: meteorologia-oceanografia@chm.mar.mil.br

Canada: <http://ice-glaces.ec.gc.ca>

Canadian Ice Service - Environment Canada

Address: 373 Sussex Drive, Block E, Ottawa, Ontario, Canada K1A 0H3

Phone: +1-800-668-6767

Hours: 0830L-1630L

E-mail: cis-scg.client@ec.gc.ca / enviroinfo@ec.gc.ca

Chile: <http://www.shoa.cl/index.html>

Chilean Navy Weather Service

Address: Errazuriz Echaurren 254 Playa Ancha, Valparaíso, Chile

Phone: +61 220 1161, Punta Arenas Duty Number

Hours: 24/7

E-mail: meteomag@directemar.cl

China: <http://english.nmefc.gov.cn>

National Marine Environment Forecast Centre

Address: 8, Dahuisi Rd., Haidian District, Beijing, 100081

Phone: Phone not available.

Hours: 0800L-1700L

E-mail: webmaster@nmefc.gov.cn

Denmark:

<http://www.dmi.dk/en/groenland/hav/ice-charts>

Danmark Meteorologiske Institut

Address: Lyngbyvej 100, DK-2100 Copenhagen

Phone: +45 39 15 72 45

Hours: 0800L-1700L

E-mail: iskort@dmi.dk

Estonia: <http://www.emhi.ee>

Estonian Meteorological and Hydrological Institute (EMHI)

Address: Rävala 8, EE-0001 Tallin, Estonia

Phone: TBD

Hours: 0800L-1700L

E-mail: mere@emhi.ee

Finland: <http://en.ilmatieteenlaitos.fi/ice-conditions>

Finnish Meteorological Institute, Ice Service

Address: P.O. Box 503, FIN-00101 Helsinki, Finland

Phone: +358 29 539 3464

Hours: 0800L-1700L

E-mail: iceservices@fmi.fi

Germany:

http://www.bsh.de/en/Marine_data/Observations/Ice/index.jsp

BSH-Eisdienst

Address: Neptunallee 5, 18069 Rostock, Germany

Phone: +49 381-4563780

Emergency Phone: +49 381-4563781 (with voice mail and contact information for off-office hours)

Hours: 0800L-1700L

E-mail: ice@bsh.de

Greenland: <http://www.dmi.dk/vejir>

Danish Meteorological Institute (DMI)

Ice Patrol Narsarsuaq

Address: PO Box 505, 3923 Narsarsuaq, Greenland

Phone: + 299 66 52 44 24/7 Emergency Representative

Hours: 0800L-1600L Monday thru Friday; 24/7 # always available

E-mail: icepatrol@dmi.dk

Iceland: <http://www.vedur.is>

Icelandic Meteorological Office

Address: Bustadavegur 9, IS-150 Reykjavik

Phone: + 354 522 6000 ** English recording, Can press 5 to access 24/7 Emergency Representative

Hours: 0830L-1600L Monday thru Friday; 24/7 response available

E-Mail: [fyrirspurnir\(at\)vedur.is](mailto:fyrirspurnir(at)vedur.is)

Japan: http://ds.data.jma.go.jp/gmd/goos/data/rrtdb/jma-pro/man_ice_okh_D.html

Japan Meteorological Agency

Address: 1-3-4 Otemachi Chiyoda-ku, Tokyo, 100-8122, Japan

Phone: Not Available

Hours: 0800L-1700L

E-Mail: seaice@climar.kishou.go.jp

Latvia: <http://www.meteo.lv>

Latvian Environment, Geology and Meteorology Centre

Address: 165 Maskavas Str, LV1019, Riga, Latvia

Phone: +371 67 032 609

Hours: 0800L-1700L (outside working hours - forecaster on duty)

E-Mail: marine@meteo.lv

Lithuania: <http://www.meteo.lt/english>

Lithuanian Hydrometeorological Service

Address: Rudnios str 6, 09300 Vilnius, Lietuva

Phone: +3706 252247 voicemail not monitored

Hours: 0800L-1700L

E-Mail: lhmet@meteo.lt

Netherlands:

http://www.infocentrum_binnenwateren.nl.ijskaart

Rijkswaterstaat/Riza Centre for Water Management Information and Warning Centre

Address: Infocentrum Binnenwateren, Postbox 17, 8200 AA Lelystad

Phone: +31-320 298 888

Hours: 24/7

E-mail: infocentrum@riza.rws.nl

Norway: http://www.met.no/English/Ocean_and_Ice

MET Norway

Norwegian Ice Service

Address: Vevarslinga for Nord-Norge, Postboks 6314 Langnes, NO-9293 Tromsø

Phone: +47 7762 1300

Hours: 24/7

Norwegian Coastal Administration: +47 33 034800

(pollution cases), 24/7

Search and Rescue Coordination Center: +47 51 517000 (SAR cases), 24/7

E-Mail: istjenesten@met.no

Poland:

<http://www.baltyk.pogodynka.pl//index.php?page=2&sub-page=64>

Instytut Meteorologii i Gospodarki Wodnej - PIB (IMGW-PIB) - Oddział Morski

Ice Service

Address: Waszyngtona 42, PL 81-342 Gdynia

Phone: +48-58 62 88 146 (Ice Team)

Hours: 0730L-1500L, Monday-Friday

Fax: +48 58 620 16 41

Emergency: +48-58 62 88 151, 24/7

E-mail: hydrologia.gdynia@imgw.pl

Russian Federation: <http://www.aari.ru>

Arctic and Antarctic Research Institute (AARI)

Address: 38, Bering Str., St.Petersburg, Russia 199397

Phone: +7 812 337-3168 (hours: 0900-1900UTC+0300)

Phone: +7 921 865-4056 (hours: 1900-0900UTC+0300)

Fax: +7 812 337-3241 (24/7)

E-mail: sat_info@aari.ru, service@aari.ru

Sweden: www.smhi.se

Swedish Meteorological and Hydrological Institute (SMHI)

Ice Service

Address: S-601 76 Norrköping

Phone: +46-11 495 8533 ** Recorded message in Swedish and English

Hours: 0800L-1600L

E-mail: ice@smhi.se

United Kingdom: <http://www.metoffice.gov.uk>

Meteorological Office

Address: FitzRoy Road, Exeter, Devon EX1 3PB, United Kingdom

Phone: +44 1392 885680

Hours: 0800L-1700L

E-mail: enquiries@metoffice.gov.uk

United States

U.S. National Ice Center: <http://www.natice.noaa.gov>

Address: 4251 Suitland Road, NSOF, Washington, DC 20395

Phone: +301-943-6977

Hours: 0730L-1600L, Duty Officer - 24/7

E-mail: nic.cdo@noaa.gov

International Ice Patrol: <http://www.navcen.uscg.gov/iip>

Address: 1 Chelsea St., New London, CT 06320

Phone: +1-860 271 2626, Operations Center (forwarded to Watch Cell after hours)

Watch Cell Phone: 1 860 235 8171

Hours: 0730-1600 EST (Minimum); Watch phone - 24/7

E-Mail: iipcomms@uscg.mil

U.S. National Weather Service:

<http://pafc.arh.noaa.gov/ice.php>

Ice Desk-NWS Anchorage

Address: 6930 Sand Lake Road, Anchorage, AK 99502

Phone: (907) 266-5138

Emergency: (907) 271-6540, press 0 after hours for emergency

Hours: 0630L-1530L

E-Mail: nws.ar.ice@noaa.gov

CHAPTER 33

POLAR NAVIGATION

POLAR REGIONS

3300. Introduction

The complex challenge of clearly defining the limits of Earth's polar regions is problematic, yielding diverse conclusions determined by the different desires of interested parties. Astronomically, the parallels of latitude at which the sun becomes circumpolar (the Arctic and Antarctic Circles at about latitude 67.5°) are considered the lower limits. As of December 27, 2016, the lower limit runs $66^\circ 33' 46.5''$ north of the Equator. Its latitude depends on the Earth's axial tilt, which fluctuates within a margin of 2° over a 40,000-year period, due to tidal forces resulting from the orbit of the Moon. Consequently, the Arctic Circle is currently drifting northwards at a speed of about 15 m (49 ft) per year.

Meteorologically, however, the limits are irregular lines which, in the Arctic, coincides approximately with the tree line. For general purposes, the navigator may consider polar regions as extending from the geographical poles of the earth to latitude 75° (in the Arctic coinciding approximately with the northern coast of Alaska). These areas are considered "high latitude" by the U.S. Navy. Transitional **subpolar regions** extending for an additional 10° (in the Northern Hemisphere extending to the southern tip of Greenland).

This chapter deals primarily with marine navigation in high latitudes.

3301. A Changing Landscape in the Arctic

Scientific research and projections of the changes taking place in the Arctic vary, but there is a general consensus that Arctic sea ice is diminishing. As recently as September 2011, scientists at the U.S. National Snow and Ice Data Center reported that the annual Arctic minimum sea ice extent for 2011 was the second lowest in the satellite record, and 938,000 square miles below the 1979 to 2000 average annual minimum. Much of the Arctic Ocean remains ice-covered for a majority of the year, but some scientists have projected that the Arctic may be ice-diminished for periods of time in the summer by as soon as 2040.

The environmental changes taking place in the Arctic are making maritime transit more feasible and are increasing the likelihood of further expansion of human activity, including tourism, oil and gas extraction, commercial ship-

ping, and fishing in the region. For example, in 2011, northern trans-shipping routes opened during the summer months, which permitted more than 40 vessels to transit between June and October. The Northern Sea Route opened in mid-August, and appeared to remain open through September, while the Northwest Passage opened for periods in the summer for the fifth year in a row. See Figure 3301 for locations of these shipping routes.

Despite these changes, several enduring characteristics still provide challenges to surface navigation in the Arctic, including large amounts of winter ice and increased movement of ice from spring to fall. Increased movement of sea ice makes hazard reporting less predictable, a situation that is likely to increase the risk for ships to become trapped or damaged by the ice. This chapter provides a description of these challenges to polar navigation.

3302. Polar Geography

The north polar region, the Arctic, consists of an elongated central water area slightly less than that of the United States, almost completely surrounded by land (Figure 3302a). Some of this land is high and rugged with permanent ice caps, but part of it is low and marshy when thawed. Underlying permafrost prevents adequate drainage, resulting in large numbers of lakes and ponds and extensive areas of muskeg, which is a soft spongy ground having a characteristic growth of certain types of moss and tufts of grass or sedge. There are also large areas of tundra, low treeless plains with vegetation consisting of mosses, lichens, shrubs, willows, etc., and usually having an underlying layer of permafrost. The northernmost point of land is Kap Morris Jessup, Greenland, about 380 nautical miles from the pole.

The central part of the Arctic Ocean, as the body of water is called, is a basin with about 12,000 feet average depth. However, the bottom is not consistent, having a number of seamounts and deeps. The greatest depth is probably a little more than 16,000 feet. At the North Pole the depth is 14,150 feet. Surrounding the polar basin is an extensive continental shelf, broken only in the area between Greenland and Svalbard (Spitsbergen). The many islands of the Canadian archipelago lie on this shelf. The Greenland Sea, east of Greenland, Baffin Bay, west of Greenland, and the Bering Sea, north of the Aleutians, each has its independent basin. In a sense, the Arctic Ocean is an arm of

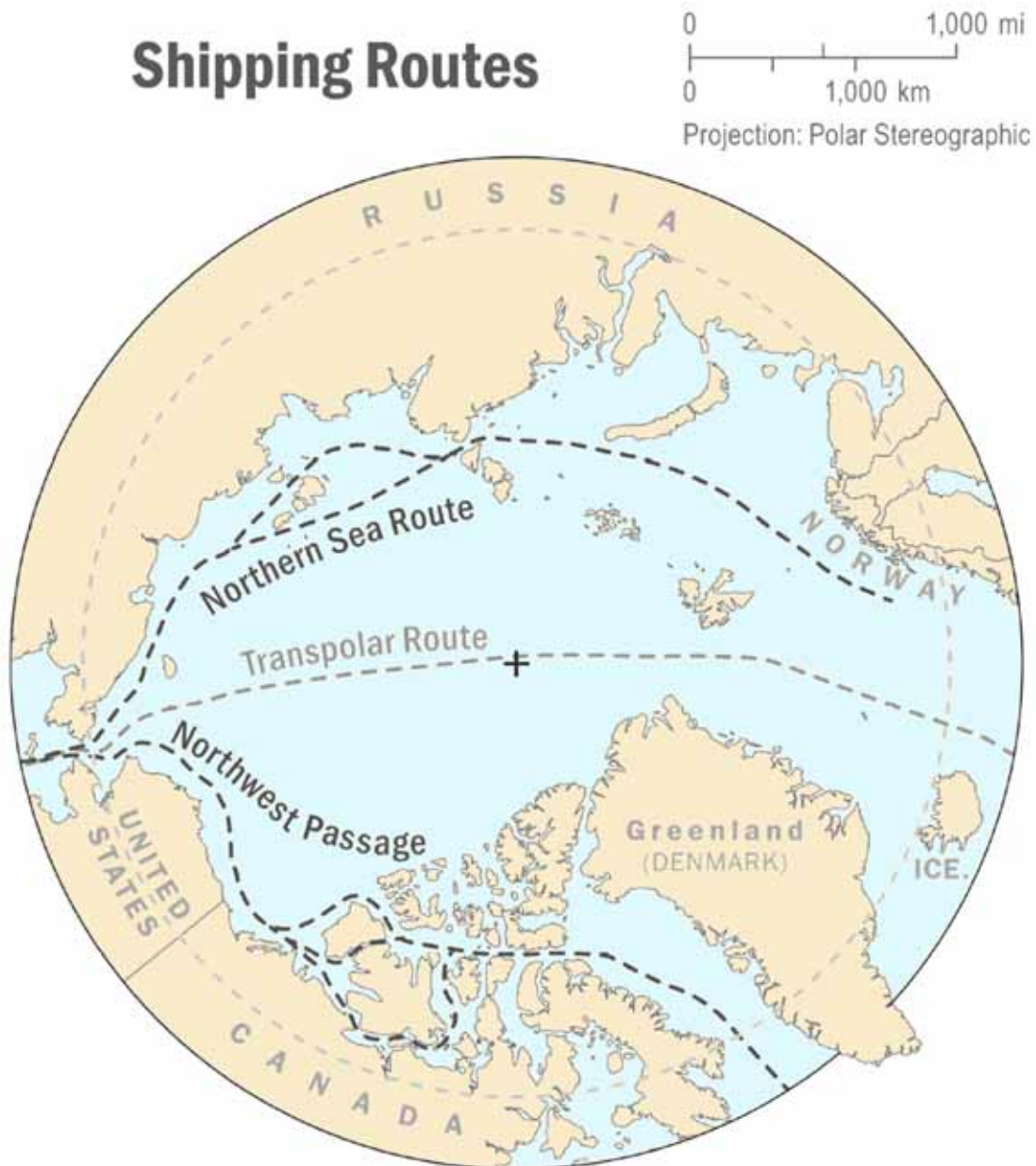

Figure 3301. Polar shipping routes.

the Atlantic.

The south polar region of the Antarctic is in marked contrast to the Arctic in geographical features. Here a high, mountainous land mass about twice the area of the United States is surrounded by water (Figure 3302b). An extensive polar plateau covered with snow and ice is about 10,000 feet high. There are several mountain ranges with peaks rising to heights of more than 13,000 feet. The average height of Antarctica is about 6,000 feet, which is higher than any other continent. The height at the South Pole is about 9,500 feet. The barrier presented by land and tremen-

dous ice shelves 500 to 1,000 feet thick prevent ships from reaching very high latitudes. Much of the coast of Antarctica is high and rugged, with few good harbors or anchorages.

3303. Shipping in Polar Waters

While there has historically been regular shipping, especially along the Russian coast in the summer seasons, the amount of shipping and traffic in the Arctic has increased substantially over the last decade. The increase is due to many factors, including interest in the arctic

The Arctic Ocean Floor

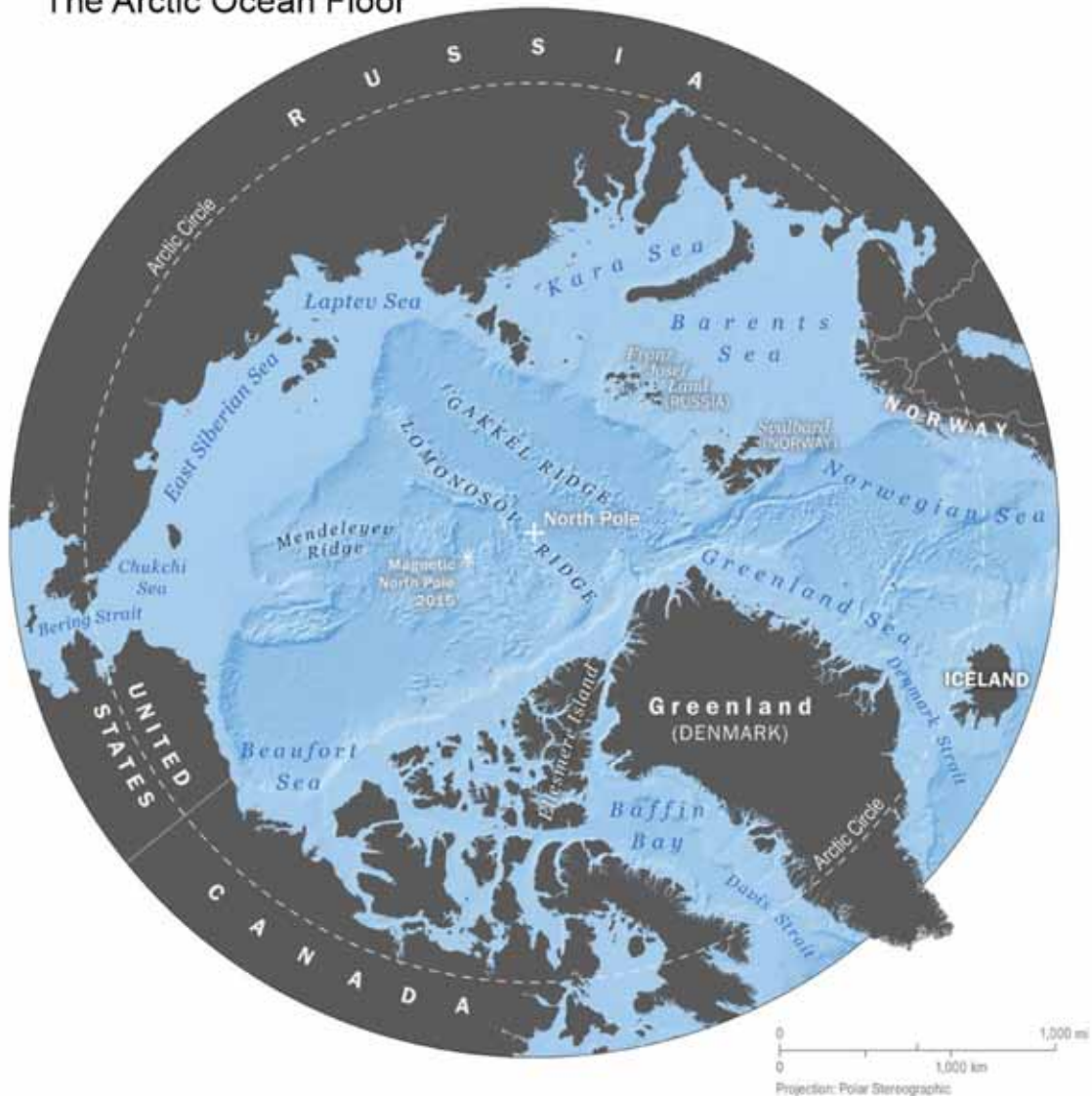

Figure 3302a. The Arctic Ocean floor and surrounding land masses.

environment, tourism, oil and gas exploration, and exploitation. This has been allowed by the overall reduction in sea ice for greater parts of the year, and the potential for reduced shipping costs using the arctic sea routes.

There are two major surface routes through the Arctic, the **Northwest Passage (NWP)** along the Canadian Archipelago, and the Russian Federation **Northern Sea Route (NSR)**. See Figure 3301.

All NWP passages have common eastern and western approaches. In the east, ships must proceed through the Labrador Sea, Davis Strait and Baffin Bay. In the western approaches ships proceed through the Bering Sea, Bering Strait, the Chukchi Sea and the Beaufort Sea before deciding which route to follow. In general, the operating season is

short (from late July to mid-October) depending on the route and year. Of the various passages listed below, routes 1 and 2 are considered deep water ones, while the others have limiting shoals and rocks restricting the draft of vessels to less than 10 meters.

Routes Through the NWP

1. Routing (East to West): Lancaster Sound - Barrow Strait - Viscount Melville Sound - Prince of Wales Strait - Amundsen Gulf.
2. Routing (East to West): Same as 1 but substitute M'Clure Strait for Prince of Wales Strait and Amundsen Gulf. Collectively Lancaster Sound -

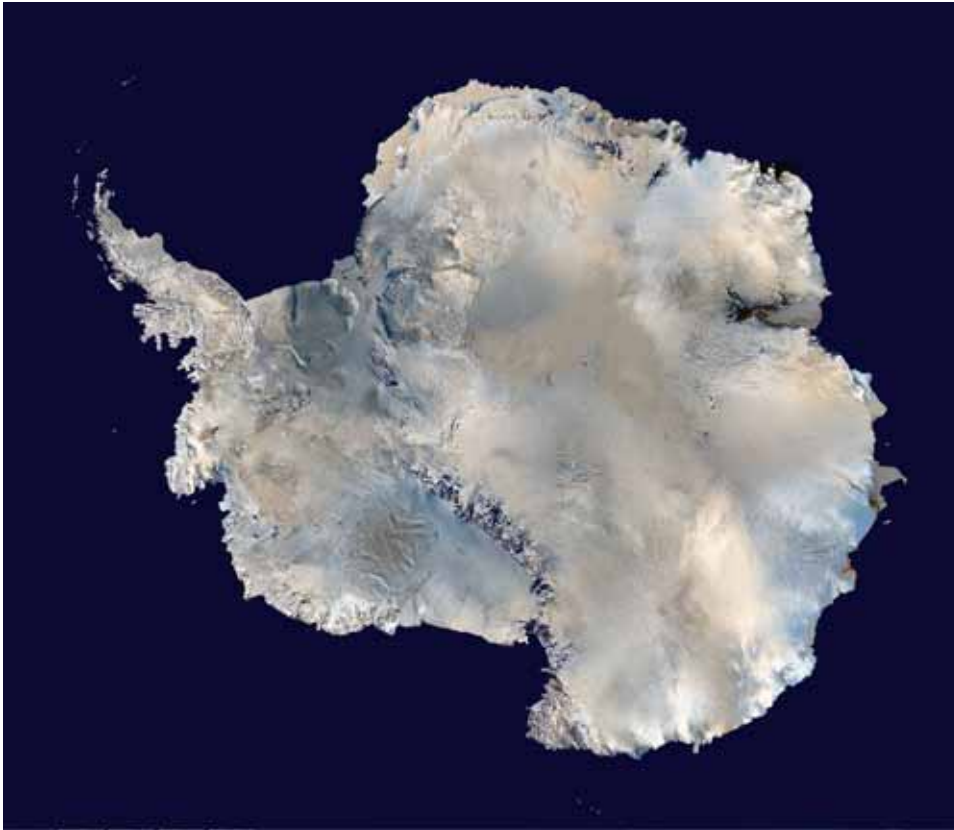

Figure 3302b. A satellite composite image of Antarctica.

Barrow Strait - Viscount Melville Sound is known as Parry Channel.

3. Routing (East to West): Lancaster Sound - Barrow Strait - Peel Sound - Franklin Strait - Larsen Sound - Victoria Strait - Queen Maud Gulf - Dease Strait - Coronation Gulf - Dolphin and Union Strait - Amundsen Gulf.
4. Routing (East to West): A variation of 3. Rather than following Victoria Strait on the west side of King William Island, the route passes to the east of the island following James Ross Strait - Rae Strait - Simpson Strait.
5. Routing (East to West): Similar to 3. Rather than following Peel Sound on the west side of Somerset Island, the route passes to the east of the island through Prince Regent Inlet and Bellot Strait.
6. Routing (East to West): Hudson Strait - Foxe Channel - Foxe Basin - Fury and Hecla Strait - Gulf of Boothia - Bellot Strait - remainder via routes 3, 4 or 5.

The Russian Federation NSR is a shipping route officially defined by Russian legislation as lying east of Novaya Zemlya and specifically running along the Russian Arctic coast from the Kara Sea, along Siberia, to the Bering Strait. The entire route lies in Arctic waters and within Rus-

sia's Exclusive Economic Zone (EEZ). Parts are free of ice for only two months per year.

3304. Polar Code

To support increases in shipping traffic the International Maritime Organization (IMO) adopted the International Code for Ships Operating in Polar Waters (Polar Code) and related amendments to make it mandatory under both the International Convention for the Safety of Life at Sea (SOLAS) and the International Convention for the Prevention of Pollution from Ships (MARPOL). The Polar Code is intended to cover the full range of shipping-related matters relevant to navigation in waters surrounding the two poles including: ship design, construction and equipment; operational and training concerns; search and rescue; and, equally important, the protection of the unique environment and eco-systems of the polar regions. The Polar Code is available online via the link provided in Figure 3304.

3305. High-Latitude Effects

Special techniques have been developed to adapt navigation to the unique conditions of polar regions. These conditions are largely the result of high latitude, the environment and meteorological factors.



Figure 3304. The Polar Code

<http://www.imo.org/en/MediaCentre/HotTopics/polar/Documents/POLAR%20CODE%20TEXT%20AS%20ADOPTED.pdf>

Much of the thinking of the marine navigator is in terms of the “rectangular” world of the Mercator projection, on which the meridians are equally spaced, vertical lines perpendicular to the horizontal parallels of latitude. Directions are measured relative to the meridians, and are maintained by means of a magnetic or gyrocompass. A straight line on the chart is a rhumb line, the line used for ordinary purposes of navigation. Celestial bodies rise above the eastern horizon, climb to a maximum altitude often high in the sky as they cross the celestial meridian, and set below the western horizon. By this motion the sun divides the day naturally into two roughly equal periods of daylight and darkness, separated by relatively short transitional periods of twilight. The hour of the day is associated with this daily motion of the sun.

In polar regions conditions are different. Meridians all converge at the poles, which are centers of a series of concentric circles constituting the parallels of latitude. The rapid convergence of the meridians renders the usual convention of direction inadequate for some purposes. A rhumb line is a curve which differs noticeably from a great

circle, even for short distances. Even visual bearings cannot adequately be represented as rhumb lines. At the pole all directions are south or north, depending upon the pole. Direction in the usual sense is replaced by longitude. The mariner must also remember that the geographic pole and the magnetic pole are not coincidental.

At the pole the **zenith** and **celestial pole** coincide. Hence, the celestial horizon and celestial equator also coincide, and declination and computed altitude are the same. Therefore, celestial bodies change computed altitude only by changing declination. Stars circle the sky without noticeable change in altitude. Planets rise and set once each sidereal period (12 years for Jupiter, 30 years for Saturn). At the North Pole the sun rises about March 21, slowly spirals to a maximum altitude of about $23^{\circ}27'$ near June 21, slowly spirals downward to the horizon about September 23, and then disappears for another six months. At the South Pole, a similar cycle takes place, but during the opposite time of year. It requires about 32 hours for the sun to cross the horizon, during which time it circles the sky 1 and $\frac{1}{3}$ times. The twilight periods following sunset and preceding sunrise last for several weeks. The moon rises and sets about once each month. Only celestial bodies of north declination are visible at the North Pole; only bodies of south declination are visible at the South Pole.

The long polar night is not wholly dark. The full moon at this time rises relatively high in the sky. Light from the **aurora borealis** in the Arctic and the **aurora australis** in the Antarctic is often quite bright, occasionally exceeding that of the full moon (see Figure 3305a). Even the planets and stars contribute an appreciable amount of light in this area where a snow cover provides an excellent reflecting surface.



Figure 3305a. Aurora borealis above Lyngenfjorden, Norway in March 2012. Image by Simo Räsänen, Wikimedia Commons.

All time zones, like all meridians, meet at the poles. Local time does not have its usual significance, since the hour of the day bears no relation to periods of light and darkness or to altitude of celestial bodies.

3306. Meteorological Effects

Polar regions are cold, but the temperature at sea is not as extreme as inland. The average winter temperature over

the Arctic Ocean is - 30°F to - 40°F, with an extreme low value near - 60°F. Colder temperatures have been recorded in Yellowstone National Park. During the summer the temperature remains above freezing over the ocean. Inland, extreme values are sometimes reached. At least one point on the Arctic Circle has experienced a temperature of 100°F. Few points on the Antarctic Continent have recorded temperatures above freezing, and the interior is probably the coldest part of the world.

Fog and clouds are common in polar regions, yet there is less precipitation than in some desert regions, since the cold air has small capacity for holding moisture. Very cold air over open water sometimes produces steaming of the surface, occasionally to a height of several hundred feet. This is called frost smoke or **sea smoke**. When there is no fog or frost smoke, the visibility is often excellent. Sounds can sometimes be heard at great distances.

Sharp discontinuities or inversions in the temperature lapse rate sometimes produce a variety of mirages and extreme values of refraction. The sun has been known to rise several days before it was expected in the spring. False horizons are not uncommon.

Strong winds are common in the subarctic and in both the Antarctic and subantarctic. The belt of water surrounding Antarctica has been characterized as the stormiest in the world, being an area of high winds and high seas. Strong winds are not encountered over the Arctic Ocean.

In the polar and subpolar regions the principal hazard to ships is ice, of which was both formed at sea or of land ice that flowed into the sea in the form of glaciers. Many low land areas are ice-free in summer. Ice is considered in more detail in Chapter 32.

When snow obliterates surface features, and the sky is covered with a uniform layer of cirrostratus or altostratus clouds, so that there are no shadows, the horizon disappears and earth and sky blend together, forming an unbroken expanse of white, without features. In these conditions landmarks cannot be distinguished, and with complete lack of contrast, distance is virtually impossible to estimate. This phenomenon is called arctic (or antarctic) **white out**. It is particularly prevalent in northern Alaska during late winter and early spring.

3307. Arctic Currents

The cold surface water of the Arctic Ocean flows outward between Greenland and Svalbard and is replaced by warmer subsurface water from the Atlantic. The surface currents depend largely upon the winds, and are generally quite weak in the Arctic Ocean. However, there are a number of well-established currents flowing with considerable consistency throughout the year. The general circulation in the Arctic is clockwise on the American side and around islands, and counterclockwise on the Asian side. Tidal ranges in this area are generally small. In the restricted waters of the upper Canadian-Greenland area

both tides and currents vary considerably from place to place. In the Baffin Bay-Davis Strait, the currents are strong and the tides are high, with a great difference between springs and neaps. In the Antarctic, currents are strong and the general circulation offshore is eastward or *clockwise* around the continent. Close to the shore, a weaker westerly, or *counterclockwise*, current may be encountered, but there are many local variations.

3308. Magnetic Poles

Since both magnetic poles are situated within the polar regions, the horizontal intensity of the earth's magnetic field is so low that the magnetic compass is of reduced value, and even useless in some areas.

The magnetic storms centered in the auroral zones disrupt radio frequency navigation and communications and alter magnetic compass sensibility. The frozen ground in polar regions is a poor conductor of electricity, another factor adversely affecting radio wave propagation.

3309. Summary of Conditions in Polar Regions

The more prominent characteristic features associated with large portions of both polar regions may be summarized as follows:

1. High latitude.
2. Rapid convergence of meridians.
3. Nearly horizontal diurnal motion of celestial bodies.
4. Long periods of daylight, twilight, and semidarkness..
5. Low mean temperatures.
6. Short, cool summers and long, cold winters.
7. High wind-chill factor.
8. Low evaporation rate.
9. Scant precipitation.
10. Dry air (low absolute humidity).
11. Excellent sound-transmitting conditions.
12. Periods of excellent visibility.
13. Extensive fog and clouds.
14. Large number and variety of mirages.
15. Extreme refraction and false horizons.
16. Winter freezing of rivers, lakes, and part of the sea.
17. Areas of permanent land and sea ice.
18. Areas of permanently frozen ground.
19. Large areas of tundra (Arctic).
20. Large areas of poor drainage, with many lakes and ponds (Arctic).
21. Large areas of muskeg (a grassy marsh when thawed) (Arctic).
22. Extensive auroral activity.
23. Large areas of low horizontal intensity of earth's magnetic field.
24. Intense magnetic storms.
25. Uncertain radio wave propagation.

- 26. Strong winds (Antarctic).
- 27. Frequent blizzards (Antarctic).

- 28. Large quantities of blowing snow.

CHARTS

3310. Projections

When navigating in polar regions, as elsewhere, charts are an indispensable component. Chart projections used for polar navigation are covered in Chapter 4, Sections 420 and 421. With the advent of modern electronic charting and voyage management systems, much of the traditional methods of positioning, such as manual computation and hardcopy plotting, are now reduced or eliminated through automation. Prudent mariners using electronic charting methods will familiarize themselves with their system's polar navigation modes prior to use, and will fully understand alternative program utilities and limitations per manufacturer specifications in order to guarantee system functionality in high latitudes.

For ordinary navigation the Mercator projection has long been the overwhelming favorite of marine navigators, primarily because a rhumb line appears as a straight line on this projection. Even in high latitudes the mariner has exhibited an understandable partiality for Mercator charts, which have been used virtually everywhere ships have gone.

However, as the latitude increases, the utility of the Mercator projection decreases, primarily because the value of the rhumb line becomes progressively less accurate. At latitudes greater than 60° the decrease in utility begins to be noticeable, and above latitude 70° it becomes problematic. In the clear polar atmosphere, visual bearings can be observed at great distances, sometimes 50 miles or more, but the use of a rhumb line to represent a bearing line introduces an error at any latitude, and at high latitudes errors become exaggerated.

Another objection to Mercator charts at high latitudes is the increasing rate of change of scale over a single chart. This results in distortion in the shape of land masses and errors in measuring distances.

At some latitudes the disadvantages of the Mercator projection outweigh its advantages. The latitude at which this occurs depends upon the physical features of the area, the configuration and orientation of land and water areas, the nature of the operation, and the experience and personal preference of the mariner. Because of differences of opinion on this matter, a transitional zone exists in which several projections may be encountered. The wise high-latitude navigator is prepared to use any of them, since coverage of the operating area may not be adequate on their favorite projection.

There are currently (2017) no standard projection recommended for polar marine operations, but this is expected to change in the near future with the increase in commercial activity in the Arctic. See Figure 3310 for link to more de-

tailed information regarding suitable projections for navigation in the Arctic, including the use of ECDIS.



Figure 3310. *Choosing Suitable Projections for Navigation in the Arctic* by the National Technical University of Athens.

http://www.iho.int/mtg_docs/rhc/ArHC/ArHC3/ARHC3-3.2.7_Suitable_projections_for_the_Arctic.pdf

Projections commonly used for polar charts are the modified Lambert Conformal, the Gnomonic, the Stereographic and the Azimuthal Equidistant. These projections are similar near the pole. They are essentially conformal, and a great circle on each is nearly a straight line. As the distance from the pole increases, however, the distinctive features of each projection become apparent:

- a. The modified Lambert conformal projection is conformal over its entire extent. The amount of scale distortion is comparatively small if it is carried only to about 25° or 30° from the pole. Beyond that, the distortion increases rapidly. A great circle is very nearly a straight line anywhere on the chart. Distances and directions can be measured directly on the chart in the same manner as on a Lambert conformal chart. However, because this projection is not strictly conformal, and on it great circles are not exactly represented by straight lines, it is not suited for highly accurate positioning.
- b. The Polar Gnomonic projection is the one polar projection on which great circles are exactly straight lines. However, a complete hemisphere cannot be represented upon a plane because the radius of 90° from the center would become infinity.
- c. The Polar Stereographic projection is conformal over its entire extent and a straight line closely approximates a great circle. The scale distortion is not excessive for a considerable distance from the pole, but it is greater than that of the modified Lambert conformal projection.
- d. The Polar Azimuthal Equidistant projection is useful for showing a large area such as a hemisphere because there is no expansion along the meridians.

However, the projection is neither conformal nor equivalent and distances cannot be measured accurately in any but a north-south direction. Great circles other than the meridians differ somewhat from straight lines. The equator is a circle centered at the pole.

- e. The two projections most commonly used for polar charts in traditional navigation are the modified Lambert Conformal and the Polar Stereographic. When a directional gyro is used as a directional reference, the track of the craft approximates a great circle. A desirable chart is one on which a great circle is represented as a straight line with a constant scale and with angles correctly represented. These requirements are not met entirely by any single projection, but they are approximated by the modified Lambert Conformal, the Polar Stereographic and the Azimuthal Polar Equidistant. The scale is more nearly constant on the Polar Equidistant, but the projection is not strictly conformal. The Polar Stereographic is conformal, and its maximum scale variation can be reduced by using a plane which intersects the earth at some parallel intermediate between the pole and the lowest parallel. The portion within this standard parallel is compressed and that portion outside is expanded.

3311. Adequacy

NOAA-provided charts and Coast Pilots are either unavailable or outdated for areas in the Arctic. Until recently, most of this region was relatively inaccessible by ship due to the presence of thick, impenetrable sea ice. Further, most Arctic waters that are charted were surveyed with imprecise technology, dating back to the 1800s. Most of the shoreline along Alaska's northern and western coasts has not been surveyed since 1960. As a result, confidence in the region's nautical charts is low. It is estimated by the Canadian Hydrographic Service (CHS) that less than 25% of the Arctic waters are surveyed to acceptable, modern standards. Much of the data is a collection of random vessel track soundings or over-ice spot soundings.

Modern U.S. navigational charts are a compilation of the best data available. Nevertheless, many of the soundings on the charts are from as early as the 1800s. Because transportation activities have increased in Arctic seaways, NOAA has been working to update outdated Arctic nautical charts to meet modern needs. In 2011, NOAA issued an *Arctic Nautical Charting Plan* after consultations with maritime interests and the public, as well as with other federal, state, and local governments. NOAA updated the plan in 2013, outlining the creation of 14 new charts to complement existing chart coverage. Since the update, NOAA released a new nautical chart for the Arctic, helping mariners navigate the Bering Strait. Chart 16190 (Bering Strait North) incorporates precise depth measurements acquired

recently by NOAA Ship Fairweather hydrographic surveys.

On October 6, 2010, NOAA led a U.S. delegation that formally established a new Arctic Regional Hydrographic Commission (ARHC) with four other nations known (together with the U.S.) as "Arctic coastal states." The commission, which also includes Canada, Denmark, Norway, and the Russian Federation, promotes cooperation in hydrographic surveying and nautical charting. The Commission provides a forum for better collaboration to ensure safety of life at sea, protect the increasingly fragile Arctic ecosystem, and support the maritime economy.

Charts of most polar areas are generally inferior to those of other regions in at least three respects:

1. *Lack of detail.* Polar regions have not been surveyed with the thoroughness needed to provide charts with traditional detail. Relatively few soundings are available and many of the coastal features are shown by their general outlines only. Large areas are perennially covered by ice, which presents a changing appearance as the position and character of the ice changes. Heavy ice cover and snow prevent accurate determination of surface features of the earth beneath. Added to this is the similarity between adjacent land features where the hundreds of points and fiords in one rugged area or the extensive areas of treeless, flat coastal land in another look strikingly alike. The thousands of shallow lakes and ponds along a flat coastal plain also lack distinctive features.
2. *Inaccuracy.* Polar charts are based upon incomplete surveys and reports of those who have been in the areas. These reports are less reliable than in other areas because icebergs are sometimes mistaken for islands, ice-covered islands are mistaken for grounded icebergs, shorelines are not easy to detect when snow covers both land and attached sea ice, inlets and sounds may be completely obscured by ice and snow, and meteorological conditions may introduce inaccuracy in determination of position. Consequently, many features are inaccurately shown in location, shape, and size, and there are numerous omissions. Isogonic lines, too, are based upon incomplete information, resulting in less than desired accuracy.
3. *Coverage.* Relatively few nautical charts of polar regions are available, and the limits of some of these are not convenient for some operations. As in other areas, charts have been made as the need has arisen. Hence, large-scale charts of some areas are completely lacking. Aeronautical charts are sometimes quite helpful, as they often show more detail of land areas than do the nautical charts. However, aeronautical charts do not show soundings.
4. *Datum.* Since charts may have not be updated using

more modern methods (i.e. GPS) such that the chart datum may be a local one or one used by earlier cartographers (i.e. NAD27). Chart datum shifts may exceed as much as 1 km under worst case circumstances.

3312. Polar Grid

Because of the rapid convergence of the meridians in polar regions, the true direction of an oblique line near the pole may vary considerably over a relatively few miles. The meridians are radial lines meeting at the poles, instead of being parallel, as they appear on the familiar Mercator chart.

Near the pole the convenience of parallel meridians is attained by means of a **polar grid**. On the chart a number of lines are printed parallel to a selected reference meridian, usually that of Greenwich. On transverse Mercator charts the fictitious meridians may serve this purpose. Any straight line on the chart makes the same angle with all grid lines. On the transverse Mercator projection it is therefore a **fictitious rhumb line**. On any polar projection it is a close approximation to a great circle. If north along the reference meridian is selected as the reference direction, all parallel grid lines can be considered extending in the same direction. The constant direction relative to the grid lines is called **grid direction**. North along the Greenwich meridian is usually taken as grid north in both the Northern and Southern Hemispheres.

The value of grid directions is indicated in Figure 3312. In this figure A and B are 400 miles apart. The true bearing of B from A is 023° , yet at B this bearing line, if continued, extends in true direction 163° , a change of 140° in 400 miles. The grid direction at any point along the bearing line is 103° .

When north along the Greenwich meridian is used as grid north, interconversion between grid and true directions is quite simple. Let G represent a grid direction, T the corresponding true direction, λ is longitude and W is the Western Hemisphere. Then for the Arctic,

$$G = T + \lambda W$$

That is, in the Western Hemisphere, in the Arctic, grid direction is found by adding the longitude to the true direction. From this it follows that,

$$T = G - \lambda W$$

and in the Eastern Hemisphere,

$$G = T - \lambda E$$

$$T = G + \lambda E$$

In the Southern Hemisphere the signs (+ or -) of the

longitude are reversed in all formulas.

If a magnetic compass is used to follow a grid direction, variation and convergence can be combined into a single correction called **grid variation** or **grivation**. It is customary to show lines of equal grivation on polar charts rather than lines of equal variation. **Isogrivs** are lines of equal grivation.

With one modification the grid system of direction can be used in any latitude. Meridians 1° apart make an angle of 1° with each other where they meet 'at the pole. The **convergence** is one, and the 360° of longitude cover all 360° around the pole. At the equator the meridians are parallel and the convergence is zero. Between these two limits the convergence has some value between zero and one. On a sphere it is equal to the sine of the latitude. For practical navigation this relationship can be used on the spheroidal earth. On a simple conic or Lambert conformal chart a constant convergence is used over the entire chart, and is known as the **constant of the cone**. On a simple conic projection it is equal to the sine of the standard parallel. On a Lambert conformal projection it is equal (approximately) to the sine of the latitude midway between the two standard parallels. When convergence is printed on the chart, it is generally adjusted for ellipticity of the earth. If K is the constant of the cone,

$$K = \sin 1/2(L_1 + L_2)$$

where L_1 and L_2 are the latitudes of the two standard parallels. On such a chart, grid navigation is conducted as explained above, except that in each of the formulas the longitude is multiplied by K :

$$G = T + K\lambda W,$$

$$T = G - K\lambda W$$

$$G = T - K\lambda E$$

$$T = G + K\lambda E$$

Thus, a straight line on such a chart changes its true direction, not by 1° for each degree of longitude, but by K° . As in higher latitudes, convergence and variation can be combined.

In using grid navigation one should keep clearly in mind the fact that the grid lines are parallel *on the chart*. Since distortion varies on charts of different projections, and on charts of conic projections having different standard parallels, *the grid direction between any two given points is not the same on all charts*. For operations which are to be coordinated by means of grid directions, *it is important that all charts showing the grid be on a single graticule* (Section 403).

3313. Arctic Navigation Background

Navigation using an inertial navigation system (INS)

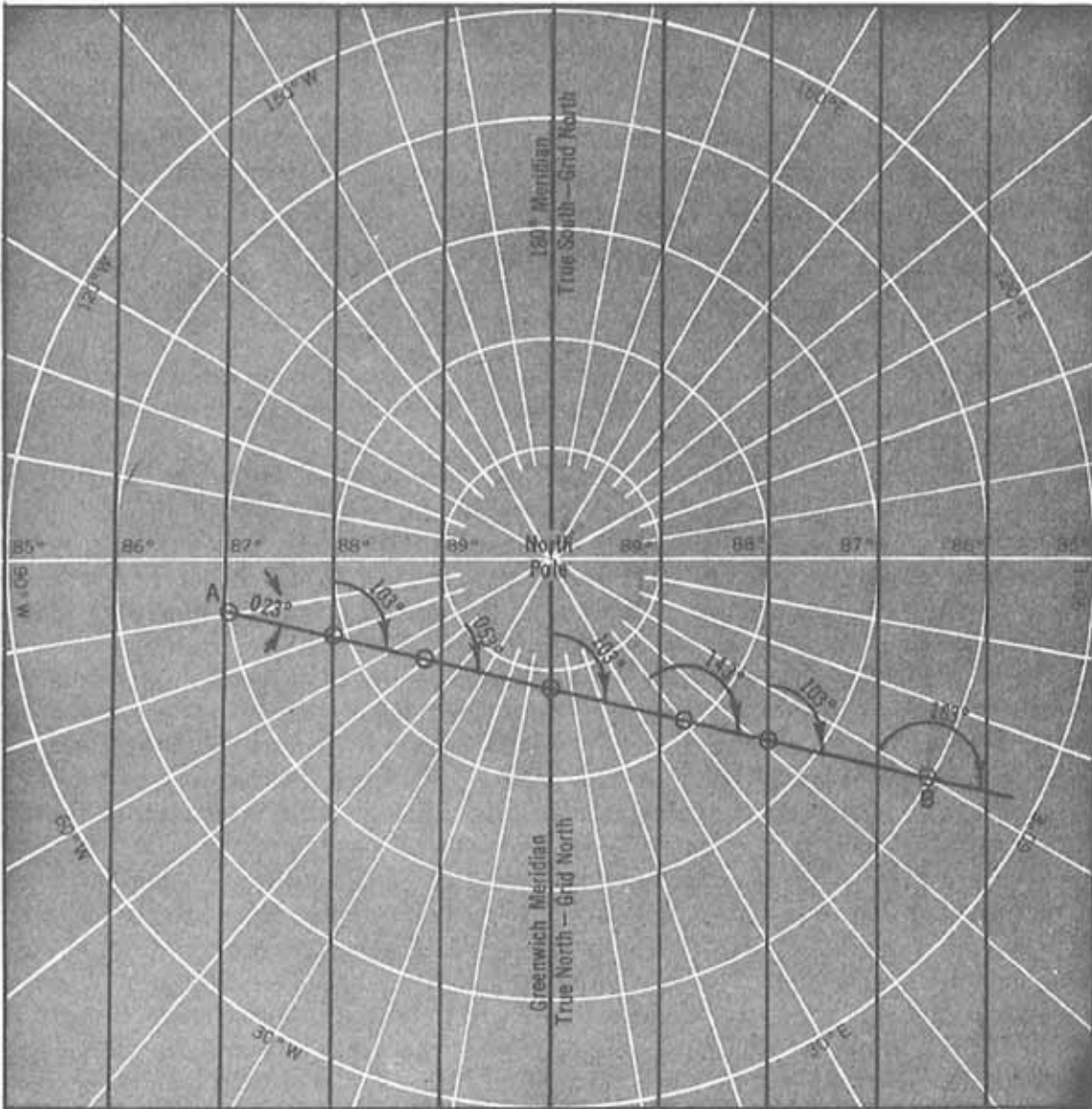

Figure 3312. Polar grid navigation.

utilizes a Local Level reference frame to represent heading and velocity quantities. The Local Level reference frame is an Earth-fixed frame, centered on the navigation system center, as in Figure 3313. The axes of the Level Frame are as follows:

Singularities arise as the vessel approaches the North pole, as the local North direction and the local East direction become undefined. (Navigation equations commonly use the tangent and secant trigonometric functions, which become indeterminate near 90°N (i.e., approach infinity)). To avoid this problem, a different coordinate system is required for operations near the North Pole.

3314. The Transverse Coordinate System

The singularity problem can be avoided by redefining the 'North' location when the vessel nears the poles. Nominally, North is equivalent to the \hat{Z} axis in the Earth Centered, Earth Fixed (ECEF) coordinate system. If this coordinate system is rotated by -90 degrees about the \hat{Y} axis, a new \hat{Z}' axis is created that represents a new North, as shown in Figure 3314.

This new coordinate system is the Transverse Coordinate System. Fortunately, the transverse coordinate process has been automated in many electronic charting and voyage management systems, eliminating the need for the naviga-

$$\begin{bmatrix} \hat{N} \\ \hat{E} \\ \hat{D} \end{bmatrix} = \begin{matrix} \text{Local North direction} \\ \text{Local East direction} \\ \text{Earth Center direction} \end{matrix}$$

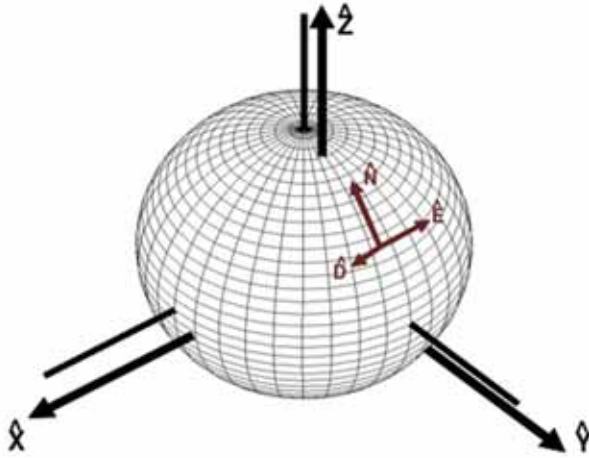

Figure 3313. Local Level and ECEF Frames.

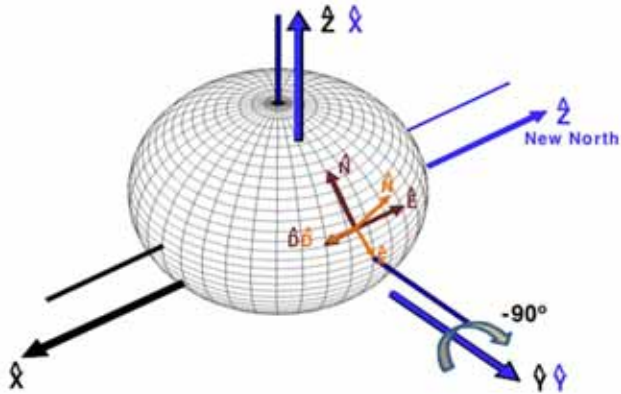

Figure 3314. Transverse and Transverse Local Level Frames.

tor to manually compute coordinate conversions. The following mathematical description of the Transverse Coordinate System is provided for completeness and to aid in understanding the processes that are occurring within the processor.

Ships equipped with INSs are required to switch to Transverse Mode to keep the INS solution from becoming unstable when tangents approach zero and to make heading

more useful. Modern INSs should have a Transverse Mode capability to generate navigation solutions in the Transverse Coordinate System. Heading, Velocity, and Position all change to Transverse Heading (THD), Transverse North and East Velocity (TNV/TEV), and Transverse Lat/Lon (TLT/TLN) when in a Transverse Mode. Chapter 20 Introduction to Inertial Navigation provides background on how INS works.

The Transverse Coordinate System and is created from the ECEF coordinate system through the following transformation: Equation 1

$$\begin{bmatrix} \hat{X}' \\ \hat{Y}' \\ \hat{Z}' \end{bmatrix} = T_E^T \begin{bmatrix} \hat{X} \\ \hat{Y} \\ \hat{Z} \end{bmatrix}$$

Where the ECEF to Transverse direction cosine matrix is: Equation 2

$$T_E^T = \begin{bmatrix} 0 & 0 & 1 \\ 0 & 1 & 0 \\ -1 & 0 & 0 \end{bmatrix}$$

A new Transverse Local Level frame is now defined as:

$$\begin{bmatrix} \hat{N}' \\ \hat{E}' \\ \hat{D}' \end{bmatrix} = \begin{matrix} \text{Transverse North direction} \\ \text{Transverse East direction} \\ \text{Earth Center direction} \end{matrix}$$

3315. Position

The Transverse Latitude and Transverse Longitude position of the vessel needs to be computed in the new Transverse coordinate system, as North and the Prime Meridian are no longer in the same location. The position in ECEF can be computed from the nominal Latitude (L) and Longitude (λ) from the following: Equation 3

$$\begin{matrix} X = R_{\emptyset} \cos L \cos \lambda \\ Y = R_{\emptyset} \cos L \sin \lambda \\ Z = R_{\emptyset} \sin L \end{matrix}$$

Likewise, the position in the Transverse coordinate system is: Equation 4

$$\begin{matrix} X' = R_{\emptyset} \cos L' \cos \lambda' \\ Y' = R_{\emptyset} \cos L' \sin \lambda' \\ Z' = R_{\emptyset} \sin L' \end{matrix}$$

Where L' and λ' are the Transverse Latitude and Transverse Longitude, respectively, and are the values that need to be computed. R_{\emptyset} is the Earth radius.

From equation 1, the following relationships hold:
Equation 5

$$\begin{aligned}\widehat{X}' &= \widehat{Z} \\ \widehat{Y}' &= \widehat{Y} \\ \widehat{Z}' &= -\widehat{X}\end{aligned}$$

Equating the two sides gives: Equation 6

$$\begin{aligned}R_{\varnothing} \cos L' \cos \lambda' &= R_{\varnothing} \sin L \\ R_{\varnothing} \cos L' \sin \lambda' &= R_{\varnothing} \cos L \sin \lambda \\ R_{\varnothing} \sin L' &= -R_{\varnothing} \cos L \cos \lambda\end{aligned}$$

Or, Equation 7

$$\begin{aligned}L' &= \sin^{-1}(-\cos L \cos \lambda) \\ X' &= \tan^{-1}\left(\frac{\sin \lambda}{\tan L}\right)\end{aligned}$$

The equation for λ' comes from: Equation 8

$$\begin{aligned}\lambda' &= \tan^{-1}\left(\frac{Z'}{X'}\right) \\ &= \tan^{-1}\left(\frac{R_{\varnothing} \cos L \cos \lambda}{R_{\varnothing} \sin L}\right) \\ &= \tan^{-1}\left(\frac{\sin \lambda}{\tan L}\right)\end{aligned}$$

3316. Vector Transformation

Vectors in Local Level Frame can be represented in the Transverse Local Level frame through a series of transformation matrices: Equation 9

$$\begin{bmatrix} a' \\ b' \\ c' \end{bmatrix} = T_T^L T_E^T T_N^E \begin{bmatrix} a \\ b \\ c \end{bmatrix}$$

Where T_T^L and T_N^E are direction cosine matrices representing the transformation from Transverse Frame (T) to Transverse Local Level (L) and from Local Level (N) to ECEF (E) frame, respectively. These matrices are defined as: Equations 10 & 11

$$T_T^L = \begin{bmatrix} -\sin L' \cos \lambda' & -\sin L' \sin \lambda' & \cos L \\ -\sin \lambda & \cos \lambda & 0 \\ -\cos L' \cos \lambda' & -\cos L' \sin \lambda' & -\sin L \end{bmatrix}$$

$$T_N^E = \begin{bmatrix} -\sin L \cos \lambda & -\sin \lambda & -\cos L \cos \lambda \\ -\sin L \sin \lambda & \cos \lambda & -\cos L \sin \lambda \\ \cos L & 0 & -\sin L \end{bmatrix}$$

The transformation matrix T_E^T is as defined in Equation 2.

3317. Velocity Transformation

Transforming a velocity from Local Level frame to Transverse Local Level is accomplished by transforming the velocity vector as previously described: Equation 12

$$\begin{bmatrix} V'_N \\ V'_E \\ V'_D \end{bmatrix} = T_T^L T_E^T T_N^E \begin{bmatrix} V_N \\ V_E \\ V_D \end{bmatrix}$$

3318. Heading Transformation

Heading in the Transverse Local Level frame is referenced to the Transverse North. As such, the nominal Local Level Heading must be transformed. This can be accomplished by creating a unit vector in local level frame as: Equation 13

$$\begin{bmatrix} H_N \\ H_E \\ H_D \end{bmatrix} = \begin{bmatrix} \cos \phi \\ \sin \phi \\ 0 \end{bmatrix}$$

Where ϕ is the heading.

This is now a vector that can be transformed into Transverse Local Level frame: Equation 14

$$\begin{bmatrix} H'_N \\ H'_E \\ H'_D \end{bmatrix} = T_T^L T_E^T T_N^E \begin{bmatrix} H_N \\ H_E \\ H_D \end{bmatrix}$$

The new Transverse Local Level Heading is: Equation 15

$$\phi' = \tan^{-1} \frac{H'_E}{H'_N}$$

3319. Plotting on Polar Charts

Plotting on polar charts, as on other charts, involves the measurement of distance and direction. Fortunately, the transverse coordinate process has been automated in many voyage management and charting systems, eliminating the need for mariner to manual compute and plot positions in

transverse coordinates on paper charts. The following information is provided on this manual process for completeness.

On a paper chart with converging meridians, as one on the Lambert conformal projection, distance is measured by means of the latitude scale, as on a Mercator chart, but this scale is so nearly constant that any part of it can be used without introducing a significant error. A mile scale is sometimes shown in or near the margin of such a chart, and can be used anywhere on that chart.

Since the meridians converge, a straight line makes a different angle with each meridian, as shown in Figure 3312. For this reason, compass roses are not customarily shown on such a chart. If they do appear, each one applies only to the meridian on which it is located. The navigator accustomed to using a Mercator chart can easily forget this

point, and hence will do well to ignore compass roses. If a drafting machine is used, it should be aligned with the correct meridian each time a measurement is made. Since this precaution can easily be overlooked, especially by navigators accustomed to resetting their drafting machine only when the chart is moved, and since the resulting error may be too small to be apparent but too large to ignore, it is good practice to discard this instrument when the Mercator chart is replaced by one with converging meridians, unless positive steps are taken to prevent error.

The most nearly fool-proof and generally most satisfactory method of measuring directions on a paper chart with converging meridians is to use a protractor, or some kind of plotter combining the features of a protractor and straightedge (Figure 3319a).

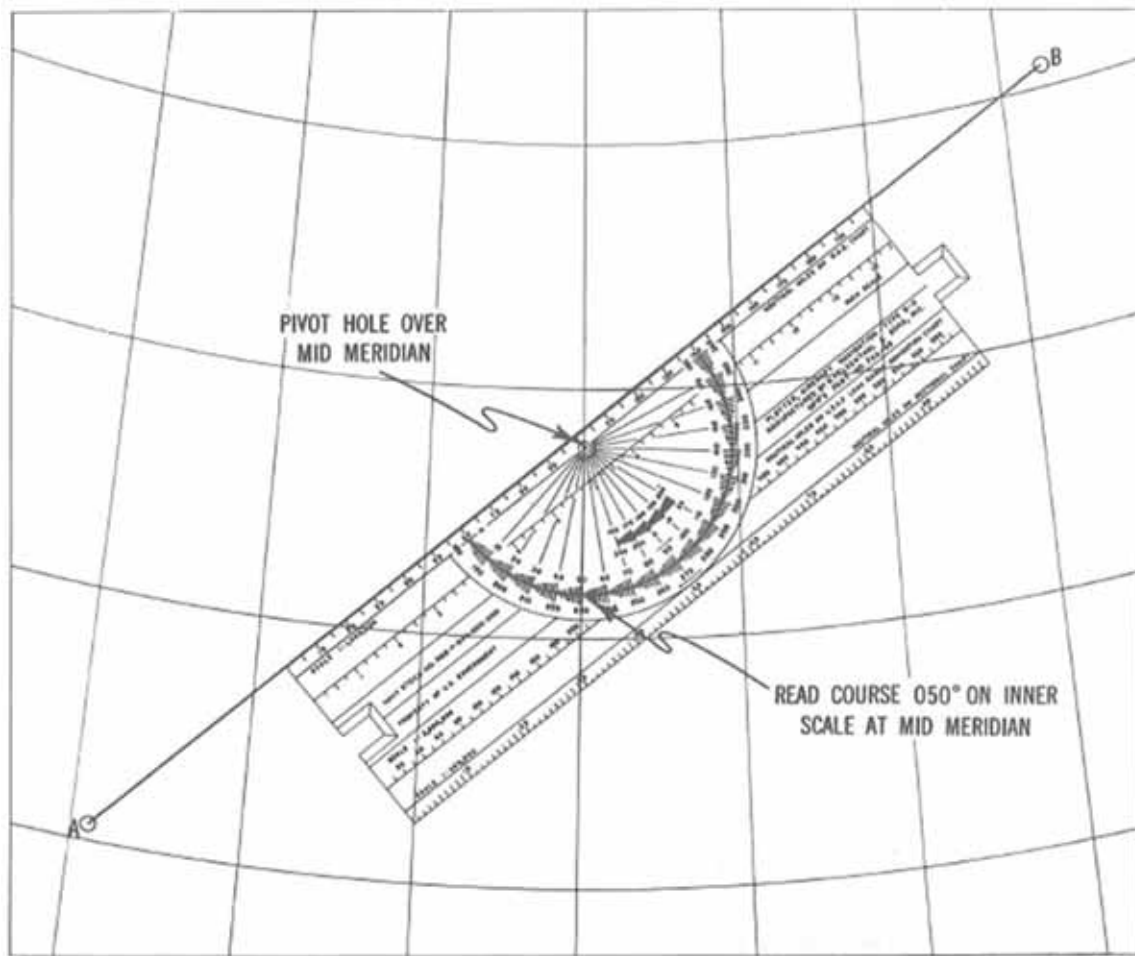

Figure 3319a. Measuring a course on a Lambert conformal chart. Note that the measurement is made at the mid meridian.

If a course is to be measured, the mid meridian of each leg should be used, as shown in Figure 3319a. If a bearing is to be measured, the meridian nearest the point at which the bearing was determined should be used, as shown in Figure 3319b. Thus, in the usual case of determining the bearing of a landmark from a ship, the meridian nearest the

ship should be used. In using either of the plotters shown in Figure 3319a or Figure 3319b, note that the center hole is placed over the meridian used, the straightedge part is placed along the line to be drawn or measured, and the angle is read on the protractor at the same meridian which passes under the center hole. It is sometimes more conve-

nient to invert the plotter, so that the protractor part extends on the opposite side of the straightedge.

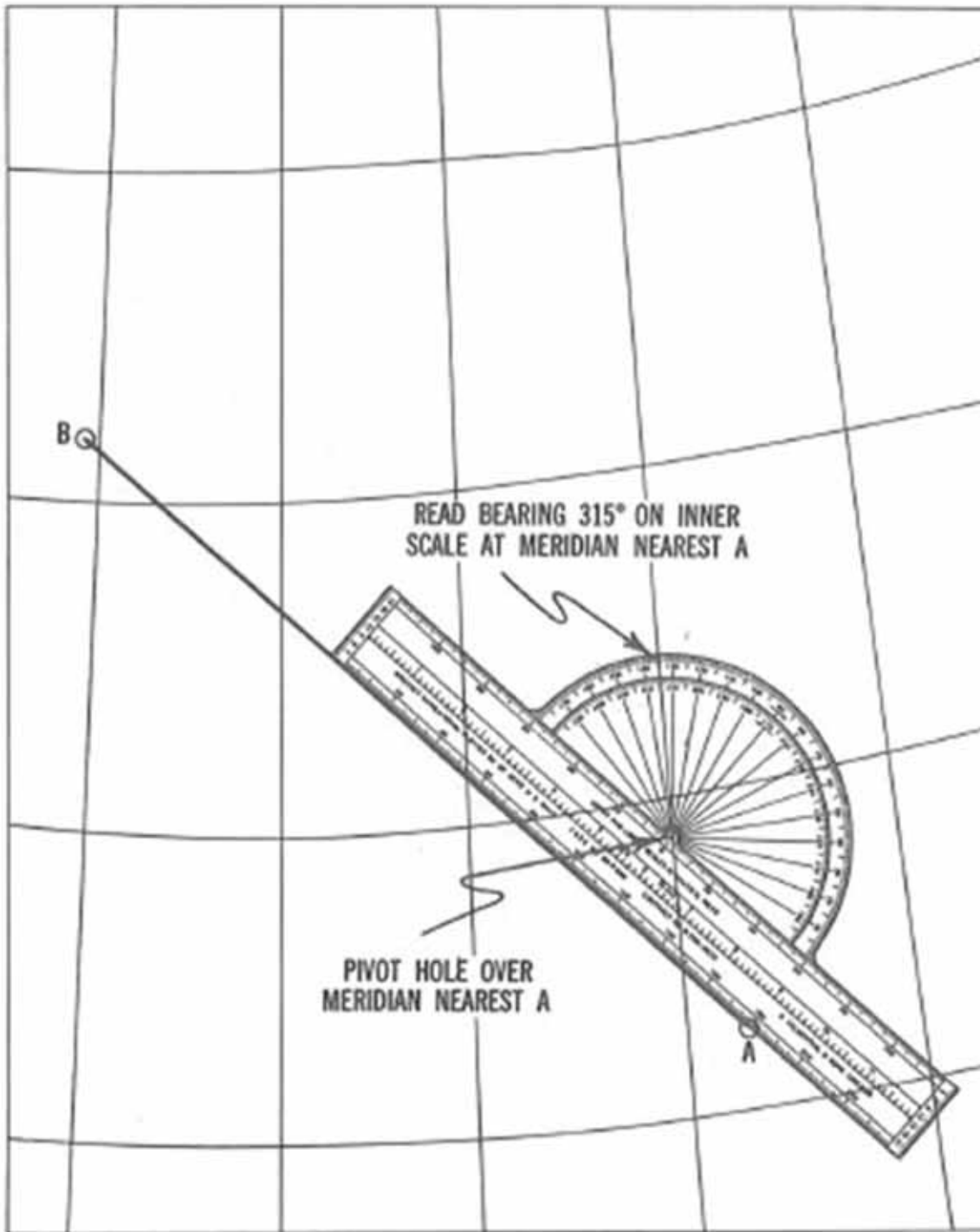

Figure 3319b. Measuring a bearing on a Lambert conformal chart. Note that the measurement is made at the meridian nearest the ship.

For plotting grid directions, angles are measured from grid north, using any grid meridian. Any convenient method can be used. If a protractor or plotter is being used for

plotting grid directions, it is usually desirable to use the same instrument for plotting true directions. The distance is the same whether grid or true directions are used.

DEAD RECKONING

3320. Polar Dead Reckoning

In polar regions, as elsewhere, dead reckoning involves measurement of direction and distance traveled, and the use of this information for determination of position. Direction is normally determined by a compass (magnetic or gyrocompass), but in polar regions both magnetic and gyrocompasses are subject to certain limitations not encountered elsewhere. GNSS Global Navigation Satellite System can also provide an independent direction of movement using satellite signals and vessel motion, but this should not be confused with the actual ship orientation. However, the navigator who thoroughly understands the use of these instruments in high latitudes can get much useful information from them. The polar navigator should not overlook the value of radar tracking or visual tracking for determining direction of motion in the absence of a GNSS. This is discussed in Section 3323.

If GNSS is not available, speed or distance is normally measured by log or engine revolution counter at normal latitudes. These backup speed measurement methods are not entirely suitable when the ship is operating in ice. The problem of determining speed or distance in ice without GNSS is discussed in Section 3323.

3321. Magnetic Compass

The magnetic compass directive force depends upon the horizontal intensity of the magnetic field of the earth. As the magnetic poles are approached, the opposing force on the compass card becomes progressively weaker until at some point the magnetic compass becomes useless as a direction-measuring device. In a marginal area it is good practice to keep the magnetic compass under almost constant scrutiny, as it will be somewhat erratic in dependability and its errors may change rapidly. Frequent compass checks by celestial observation or any other method available are wise precautions. A log of compass comparisons and observations is useful in predicting future reliability.

The magnetic poles themselves are somewhat elusive, since they participate in the normal diurnal, annual, and secular changes in the earth's field, as well as the more erratic changes caused by magnetic storms. Measurements indicate that the north magnetic pole moves within an elongated area of perhaps 100 miles in a generally north-south direction and somewhat less in an east-west direction. Normally, it is at the southern end of its area of movement at local noon and at the northern extremity twelve hours later, but during a severe magnetic storm this motion is upset and becomes highly erratic. Because of the motions of the poles, they are sometimes regarded as areas rather than points. There is some evidence to support the belief that

several secondary poles exist, although such alleged poles may be anomalies (local attractions), possibly of intermittent or temporary existence. Various severe anomalies have been located in polar areas and others may exist.

The continual motion of the poles may account, at least in part, for the large diurnal changes in variation encountered in high latitudes. Changes as large as 10° have been reported.

The decrease in horizontal intensity encountered near the magnetic poles, as well as magnetic storms, affects the magnetic deviation. Any deviating magnetic influence remaining after adjustment, which is seldom perfect, exerts a greater influence as the directive force decreases. It is not uncommon for residual deviation determined in moderate latitudes to increase 10- or 20-fold in marginal areas. Interactions between correctors and compass magnets exert a deviating influence that may increase to a troublesome degree in high latitudes. The heeling magnet, correcting for both permanent and induced magnetism, is accurately located only for one magnetic latitude. Near the magnetic pole its position might be changed, but this may induce sufficient magnetism in the Flinders bar to more than offset the change in deviation due to the change in the position of the heeling magnet. The relatively strong vertical intensity may render the Flinders bar a stronger influence than the horizontal field of the earth. When this occurs, the compass reading remains nearly the same on any heading.

Another effect of the decrease in the directive force of the compass is a greater influence of frictional errors. This combined with an increase in the period of the compass, results in greatly increased sluggishness in its return to the correct reading after being disturbed. For this reason the compass performs better in a smooth sea free from ice than in an ice-infested area where its equilibrium is frequently upset by impact of the vessel against ice.

Magnetic storms affect the magnetism of a ship as well as that of the earth. Changes in deviation of as much as 45° have been reported during severe magnetic storms, although it is possible that such large changes may be a combination of deviation and variation changes.

The area in which the magnetic compass is of reduced value cannot be stated in specific terms. A magnetic compass in an exposed position performs better than one in a steel pilot house. The performance of the compass varies considerably with the type of compass, sensibility and period, thoroughness of adjustment, location on the vessel, and magnetic properties of the vessel. It also varies with local conditions.

Based on the World Magnetic Model (WMM) 2015 coefficients the geomagnetic north pole is at 72.62°W longitude and 80.37°N latitude, and the geomagnetic south pole is at 107.38°E longitude and 80.37°S latitude. The axis

US/UK World Magnetic Model - Epoch 2015.0
Main Field Declination (D)

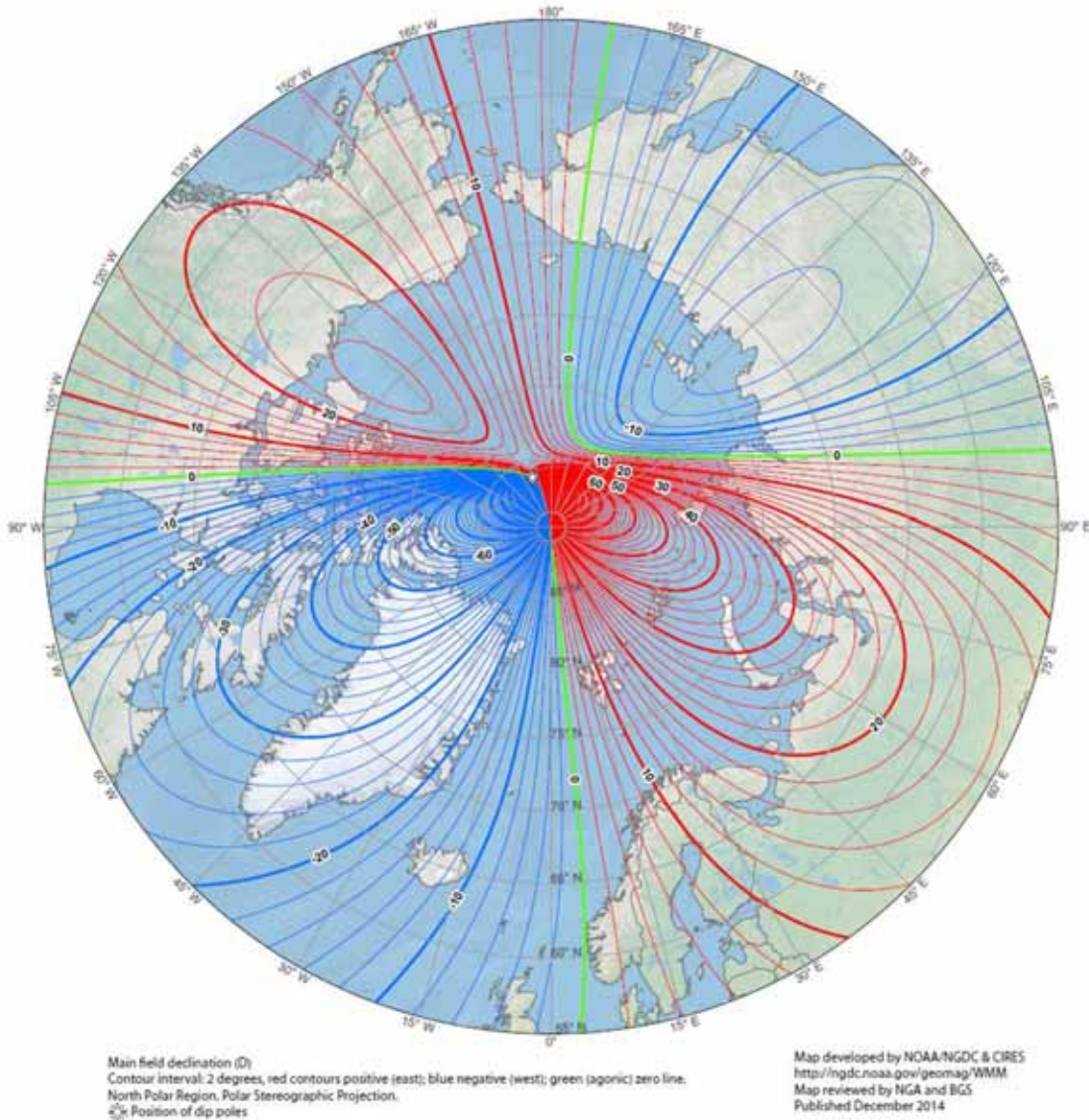

Figure 3321a. Main magnetic field declination for the North pole in 2015.

of the dipole is currently inclined at 9.69° to the Earth's rotation axis. The WMM can also be used to calculate dip pole positions. These model dip poles are computed from all the Gauss coefficients using an iterative method. In 2015 the north dip pole computed from WMM2015 is located at longitude 159.18°W and latitude 86.27°N and the south dip pole at longitude 136.59°E and latitude 64.26°S .

In a very general sense the magnetic compass can be considered of *reduced* reliability when the horizontal intensity is less than 0.09 oersted, *erratic* when the field is less than 0.06 oersted, and *useless* when it is less than 0.03 oersted. Figure 3321a and Figure 3321b shows lines of equal

horizontal intensity in the north and south polar regions, respectively. However, the effectiveness of the magnetic compass is influenced also by local conditions. A compass on a vessel making a voyage through the islands of the Canadian archipelago has been reported to give fair indication of direction in certain small areas where the horizontal intensity is less than 0.02 oersted, yet to be useless at some places where the horizontal intensity is greater than 0.04 oersted.

Despite its various limitations, the magnetic compass is a valuable instrument in much of the polar regions, where the gyrocompass is also of reduced reliability. With careful

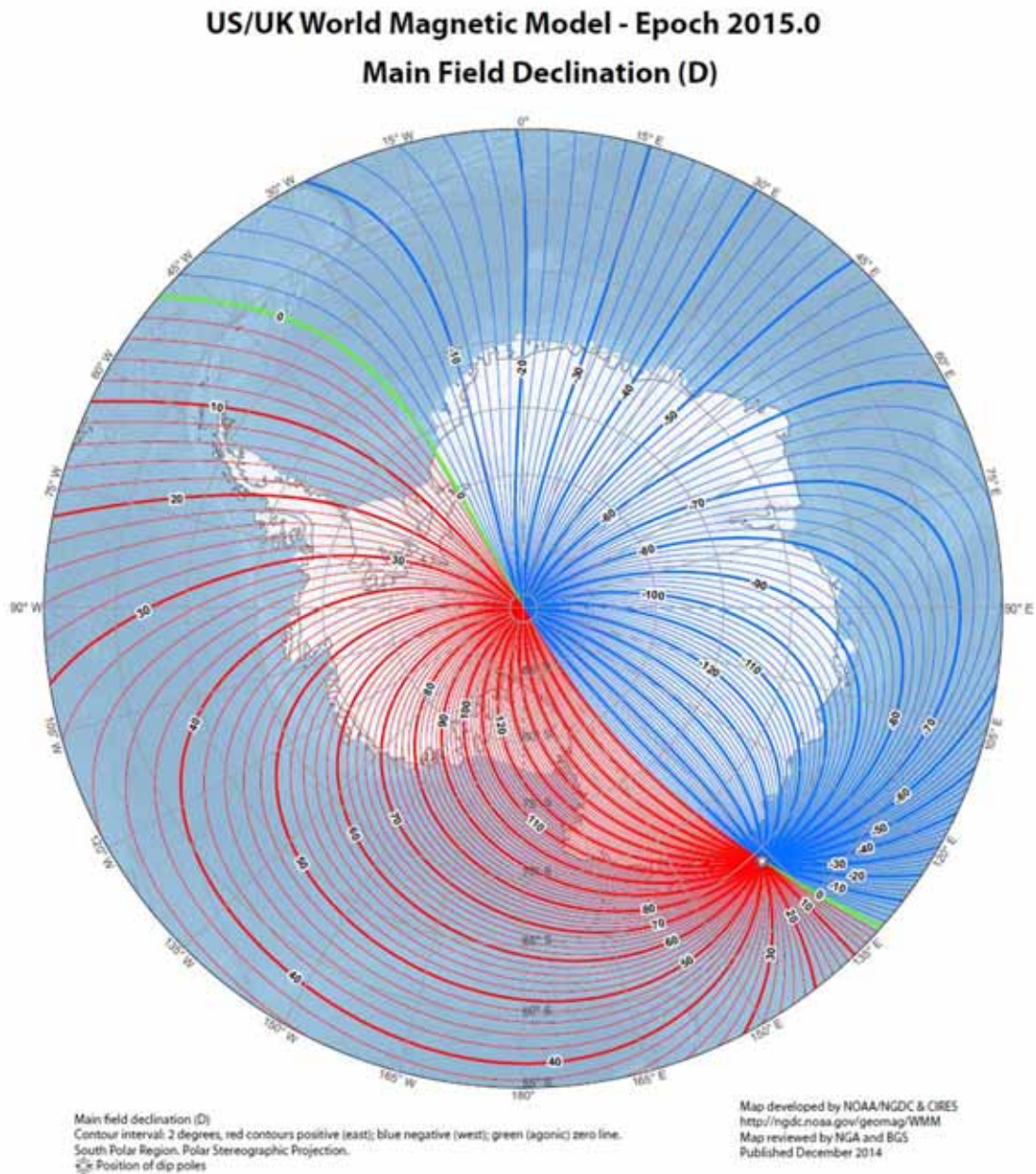

Figure 3321b. Main magnetic field declination for the South pole in 2015.

adjustment, frequent checks, and a record of previous behavior, polar navigators can get much useful service from their instruments.

When a compass is subjected to extremely low temperatures, there is danger of the liquid freezing. Sufficient heat to prevent this can normally be obtained from the compass light, which should not be turned off during severe weather.

To learn more about the magnetic poles see the NGA/NOAA World Magnetic Model (WMM) website and model derivation report via the links provided in Figure and Figure.

3322. Gyrocompass

The gyrocompass depends upon the rotation of the earth about its axis. Its maximum directive force is at the equator, where the axis of the compass is parallel to the axis of the earth. As latitude increases, the angle between these two axes increases. At the geographical poles the gyrocompass has no directive force.

The common gyrocompass is generally reliable to latitude 75°N. North of 75°N special care must be taken in checking its accuracy. Even with the compensation given by the latitude corrector on certain makes of compass, the



Figure 3321c. World Magnetic Model website
<https://www.ngdc.noaa.gov/geomag/WMM/limit.shtml>



Figure 3321d. Report on the US/UK World Magnetic Model for 2015-2020.
https://www.ngdc.noaa.gov/geomag/WMM/data/WMM2015/WMM2015_Report.pdf

gyro continues to lose horizontal force until, north of about 85°N, it generally becomes unusable. At higher latitudes the disturbing effect of imperfections in compass or adjustment is magnified. Latitude adjustment becomes critical. Speed error increases as the speed of the vessel approaches the rotational speed of the earth. Ballistic deflection error becomes large and the compass is slow to respond to correcting forces. Frequent changes of course and speed, often necessary when proceeding through ice, introduce errors which are slow to settle out. The impact of the vessel against ice deflects the gyrocompass, which does not return quickly to the correct reading.

Fiber optic gyros now have an accuracy of 1.5° at 75°N. At 85°N the accuracy is 4.5° and at 89°N the accuracy is 22° degrees. No gyro that measures the earth's rotation will work well at such high latitudes.

Gyrocompass error scales as a function of $1/\cos(\text{Latitude})$, so the error increases and becomes more erratic as the vessel proceeds to higher latitudes. At latitude 75° the gyro error should be determined frequently, perhaps every four hours, by means of celestial bodies when these are available. As the error increases and becomes more erratic, with higher latitude, it should be determined more frequently. In heavy ice at extreme latitudes an almost constant check is desirable. The gyro and magnetic compasses should be compared frequently and a log kept of the results of these comparisons and the gyro error determinations.

Most gyrocompasses may not be provided with a latitude correction setting above 70°N. Beyond this, correction can be made by either of two methods: (1) set the latitude and speed correctors to zero and apply a correction from a table or diagram obtainable from the manufacturer of the compass, or (2) use an equivalent latitude and speed setting. Both of these methods have proved generally satisfactory, although the second is considered superior to the first because it at least partly corrects for errors introduced by a change in course. In certain types of gyrocompasses, facilities for their operation in a high latitude mode, up to about 86°N, and as directional gyros, even to the poles, is provided.

The manual for the gyro compass should be consulted before entering higher latitudes. The numerous alterations in course and speed and collisions with ice can have an adverse effect on its accuracy. Therefore, when navigating in the Arctic:

- the ship's position should be cross-checked with other navigation systems, such as electronic position fixing devices, where course history could be compared with course steered (allowing for wind and current); and
- the gyro error should be checked whenever atmospheric conditions allow, by azimuth or amplitude.

Since most modern vessels use integrated digital navigation systems, an incorrect ship heading may cause erroneous position estimates if using radar fixes (with bearings having the same error as the gyrocompass). This was a factor in the *SS HANSEATIC* grounding in 1996 in the Canadian Arctic.

3323. Distance and Direction in Ice

In ice-free waters, distance or speed is determined by the installed GNSS and Electronic Chart Display and Information System (ECDIS), or Voyage Management System (VMS). As a backup, some form of log or engine revolution counter may be used as in non-polar operations, but there are some additional error sources. In the presence of ice, however, most logs are inoperative or inaccurate due to clogging by the ice. Engine revolution counters are not accurate speed indicating devices when a ship is forcing its way through ice. With experience, one can estimate the speed in relation to ice, or a correction can be applied to speed by engine revolution counter. However, these methods seldom provide desired accuracy.

If ranges and bearings of a land feature can be determined either visually or by radar, course and speed of the vessel or distance traveled over the ground can be determined by tracking the landmark and plotting the results. The feature used need not be identified. Ice can be used if it is grounded or attached to the shore. Course and speed or distance through the water can be approximately determined by tracking a floating iceberg or other prominent

floating ice feature. However, an error may be introduced by this method if the effect of wind and current upon the floating feature is different than upon the ship.

3324. Tide, Current and Wind

In general, tidal ranges are small, and the water in most anchorages is relatively deep, however, most tide tables do not extend into polar regions. NOAA manages a number of tide and current stations on the Alaskan coast. Information on Alaskan tides and currents is therefore available from the NOAA website.

Currents in many coastal areas are strong and somewhat variable. When a vessel is operating in ice, the current is often difficult to determine because of frequent changes in course and speed of the vessel and inaccuracies in the measurement of direction and distance traveled.

In the vicinity of land, and in the whole Antarctic area, winds are variable in direction, gusty, and often strong. Off-shore, in the Arctic Ocean, the winds are not strong and are

steadier, but ships rarely operate in this area. The wind in polar regions, as elsewhere, has two primary navigational effects upon vessels. First, its direct effect is to produce leeway. When a vessel is operating in ice, the leeway may be different from that in open water. It is well to determine this effect for one's own vessel. The second effect is to produce wind currents in the sea.

3325. Conclusion to Polar Dead Reckoning

Because of the potential for loss of GNSS or other aids for fixing the position of a vessel in polar regions, accurate dead reckoning as a backup is even more important than elsewhere. The problem is complicated by the fact that the elements of dead reckoning, direction and distance, are usually known with less certainty than in lower latitudes. This only heightens the need for keeping the dead reckoning with all the accuracy obtainable. This may usually be accomplished by careful hand plotting on the available paper charts or plotting sheets.

PILOTING

3326. Piloting in High Latitudes

Piloting is associated with proximity to land and shoal water, and is basically no different in high latitudes than elsewhere. Piloting is characterized by an alertness not required when a vessel is far from danger of grounding. Nowhere is this alertness more necessary than in polar regions. Added to the usual reasons for constant vigilance are the uncertainties of charted information and the lack of detail, as discussed in Section 3311. Navigators should review "Sailing Directions Pub 180 Planning Guide Arctic Ocean" for tide, current and other piloting information (see Section 3333), along with other nations' sailing directions if available.

3327. Landmarks

Natural landmarks are plentiful in some areas, but their usefulness is restricted by the difficulty in identifying them, or locating them on the chart. Along many of the coasts the various points and inlets bear a marked resemblance to each other. The appearance of a coast is often very different when many of its features are obfuscated by a heavy covering of snow or ice than when it is ice-free.

3328. Bearings

Bearings are useful, but have limitations. When bearings on more than two objects are taken, they may fail to intersect at a point because the objects may not be charted in their correct relation to each other. Even a point fix may be considerably in error geographically if all of the objects

used are shown in correct relation to each other, but in the wrong position on the earth. However, in restricted waters it is usually more important to know the position of the vessel relative to nearby land and shoals than its latitude and longitude. The bearing and distance of even an unidentified or uncharted point are valuable.

When a position is established relative to nearby landmarks, it is good practice to use this to help establish the identity and location of some prominent feature a considerable distance ahead, so that this feature, in turn, can be used to establish future positions.

In high latitudes it is not unusual to make use of bearings on objects a considerable distance from the vessel. Because of the rapid convergence of the meridians in these areas, such bearings are not correctly represented by straight lines on a Mercator chart. Additionally, as previously noted, bearing accuracy may be degraded at higher latitudes. If this projection is used, the bearings should be corrected in the same manner that radio bearings are corrected (using table 1), since both can be considered great circles. Neither visual nor radio bearings are corrected when manually plotted on a Lambert conformal or polar stereographic chart.

3329. Soundings

Soundings are so important in polar regions that echo sounders are customarily operated continuously while the vessel is underway. It is good practice to have at least two such instruments, preferably those of the recording type and having a wide flexibility in the range of the recorder. Since depth of water is a primary consideration to avoid ground-

ing, a constant watch should be maintained to avoid unobserved shoaling.

Polar regions have relatively few shoals, but in some areas, notably along the Labrador coast, a number of pinnacles and ledges rise abruptly from the bottom. These constitute a real danger to vessels, since they are generally not surrounded by any apparent shoaling. In such an area, or when entering an unknown harbor or any area of questionable safety, it is good practice to send one or more small craft ahead with portable sounding gear.

In very deep water, of the order of 1,000 meters or more, the echo returned from the bottom is sometimes confused by the sound of ice coming in contact with the hull, but this is generally not a problem when the bottom is close enough to be menacing.

If a ship becomes **beset** by ice, so that steerage way is lost and the vessel drifts with the ice, it may be in danger of grounding as the ice moves over a shoal. Hence, it is important that soundings be continued even when beset. If necessary, a hole should be made in the ice and a hand lead used. A vessel with limited means for freeing itself may prudently save such means for use only when there is danger of grounding.

Useful information on the depth of water in the vicinity of a ship can sometimes be obtained by watching the ice. A stream of ice moving faster than surrounding ice, or a stretch of open water in loose pack ice often marks the main channel through shoal water. A patch of stationary ice in the midst of moving ice often marks a shoal.

Knowledge of earth formations may also prove helpful. The slope of land is often an indication of the underwater gradient. Shoal water is often found off low islands, spits, etc., but seldom near a steep shore. Where glaciation has occurred, the moraine deposits are likely to have formed a bar some distance offshore. Submerged rocks and pinnacles are more likely to be encountered off a rugged shore than near a low, sandy beach.

3330. Anchorage

Because good anchorages are not plentiful in high latitudes, there is an understandable temptation to be less demanding in their selection. This is dangerous practice, for in polar regions some of the requirements are accentuated. The factors to be considered are:

1. *Holding quality of the bottom.* In polar regions a rocky bottom or one with only fair to poor holding qualities is not uncommon. Sometimes the bottom is steep or irregular. Since the nature of the bottom is seldom adequately shown on charts, a wise precaution is to sample the bottom, and sound in the vicinity before anchoring.
2. *Adequate room for swing.* Because high winds are frequent along polar shores, sometimes with little or no warning, a long scope of anchor chain is

customarily used. Some harbors are otherwise suitable, but allow inadequate room for swing of the vessel at anchor, or even for its yaw in a high wind. If a vessel is to anchor in an unsurveyed area, the area should first be adequately covered by small boats with portable sounding gear to detect any obstructions.

3. *Protection from wind and sea.* In polar regions protection from wind is probably the most difficult requirement to meet. Generally, high land is accompanied by strong wind blowing directly down the side of the mountains. Polar winds are extremely variable, both in direction and speed. Shifts of 180° accompanied by an increase in speed of more than 50 knots in a few minutes have been reported. It is important that ground tackle be in good condition and that maximum-weight anchors be used. All available weather reports should be obtained and a continuous watch kept on the local weather. Whenever a heavy blow might reasonably be anticipated, the main engines should be kept in an operating condition and on a standby status. Heavy seas are seldom a problem.
4. *Availability of suitable exit in event of extreme weather.* In ice areas it is important that a continuous watch be kept to prevent blocking of the entrance by ice, or actual damage to the vessel by floating ice. However, in an unsurveyed area it may be dangerous to shift anchorage without first sounding the area. It is a wise precaution to do this in advance. Unless the vessel is immediately endangered by ice, it is generally safer to remain at anchor with optimum ground tackle and use of engines to assist in preventing dragging, than to proceed to sea in a high wind, especially in the presence of icebergs and growlers, and particularly during darkness.
5. *Availability of objects for position determination.* The familiar polar problem of establishing a position by inaccurately charted or inadequately surveyed landmarks is accentuated when an accurate position is desired to establish the position of an anchor. Sometimes a trial and error method is needed, and it may be necessary to add landmarks located by radar or visual observation. Because of chart inadequacy, the suitability of an anchorage, from the standpoint of availability of suitable landmarks, cannot always be adequately predicted before arrival.

An unsurveyed harbor should be entered with caution at slow speed, with both the pilot house and engine room watch-standers alerted to possible radical changes in speed or course with little or no warning. The anchor should be kept ready for letting go on short notice and should be adequately attended. An engine combination providing full

backing power should be maintained.

3331. Sailing Directions

Sailing directions for high latitudes contain a wealth of valuable information acquired by those who have previously visited the areas. However, since high latitudes have not been visited with the frequency of other areas, and since these areas may have inadequate surveys, the sailing directions for polar areas are neither as complete nor as accurate as for other areas, and information on unvisited areas is completely lacking. Until traffic in high latitudes increases and the sailing directions for these areas incorporate the additional information obtained, unusual caution should accompany their use. Each vessel that enters polar regions can help correct this condition by recording accurate information and sending it to the National Geospatial-Intelligence Agency (NGA) or its counterpart in other countries. The latest edition of *Sailing Directions, Publication 180 Arctic Ocean*, should be on board for any mariners planning polar operations. *Sailing Directions* are available online via the link provided in Figure 3331a

For additional information on the Arctic and ice navigation in Canadian waters see the link provided in Figure 3331b.



Figure 3331a. *Sailing Directions (Planning Guides)*
https://msi.nga.mil/NGAPortal/MSI.portal?_nfpb=true&_pageLabel=msi_portal_page_62&pubCode=0011



Figure 3331b *Ice Navigation in Canadian Waters.*
<http://www.ccg-gcc.gc.ca/folios/00913/docs/ice-navigation-dans-les-galces-eng.pdf>

ELECTRONICS AND POLAR NAVIGATION

3332. Propagation

In general, radio wave propagation in high latitudes follows the same principles that apply elsewhere, as described in Chapter 21. However, certain anomalous conditions occur, and although these maybe imperfectly understood, and experience to date has not always seemed consistent, there is much information that has been established. An understanding of these conditions is important if maximum effective use is to be made of electronics in high latitudes. Such anomalous conditions are discussed in Chapters 21 and 24.

3333. Radar

In polar regions, where fog and long periods of continuous daylight or darkness reduce the effectiveness of both celestial navigation and visual piloting, and where other electronic aids are generally not available, radar is particularly valuable. Its value is further enhanced by the fact that polar seas are generally smooth, resulting in relatively little oscillation of the shipborne antenna. When ice is not present, relatively little sea return is encountered from the calm sea. In general, Arctic or cold conditions do not affect the performance of radar systems. Occasionally weather conditions may cause ducting, which is the bending of the radar beam because of a decline in moisture content in the atmo-

sphere. This effect may shorten or lengthen target detection ranges, depending on the severity and direction of the bending. A real problem with radar in the Arctic concerns interpretation of the screen for purposes of position fixing. Problems encountered with position fixing arise from either mistaken identification of shore features or inaccurate surveys. Low relief in some parts of the Arctic make it hard to identify landmarks or points of land. Additionally, ice piled up on the shore or fast ice may obscure the coastline. For this reason radar bearings or ranges should be treated with more caution than measurements in southern waters. Visual observations are always preferable. Sometimes it is possible to fix the position of grounded icebergs and then to use the iceberg for positioning further along the track, if performed with caution.

Large areas of the Arctic have not yet been surveyed to the same standards as areas further south, and even some of the more recently produced charts are based on aerial photography. To decrease the possibility of errors, three lines (range, or less preferably bearings) should always be used for positions. Fixes using both sides of a channel or lines from two different survey areas should be avoided. Because of potential problems, fixes in the Arctic should always be compared with other information sources, such as electronic positioning systems.

However, certain limitations affect the use of radar in polar regions. Similarity of detail along the polar shore is

even more apparent by radar than by visual observation. Lack of accurate detail on charts adds to the difficulty of identification. Identification is even more of a problem when the shoreline is beyond the radar horizon and accurate contours are not shown on the chart. When an extensive ice pack extends out from shore, accurate location of the shoreline is extremely difficult.

Good training and extensive experience are needed to interpret accurately the returns in polar regions where ice may cover both land and sea. A number of icebergs close to a shore may be too close together to be resolved, giving an altered appearance to a shoreline, or they may be mistaken for off-lying islands. The shadow of an iceberg or pressure ridge and the lack of return from an open lead in the ice may easily be confused. Smooth ice may look like open water. In making rendezvous, one might inadvertently close on an iceberg instead of a ship.

As with visual bearings, radar bearings need correction for convergency unless the objects observed are quite close to the ship.

3334. Electronic Charts

All United States chart now use the WGS-84 Datum and ellipsoid to match the output of the GPS system, so use of any voyage management product that employs both NGA chart products and GPS will not have a datum mismatch. The use of non-US government charts with GPS are a potential problem and the prudent navigator will ensure that the datums of the chart products match, as older products may still use local datums. Russian charts are based on the Krasovsky ellipsoid (Pulkova-42/SK-42). There are some reports that a 100-meter difference may exist in each axis between WGS-84 and Pulkova-42 along the Siberian coast.

3335. Inertial Navigation Systems

Modern military inertial navigation systems (INS) are designed to operate up to the North pole. The use of transverse coordinate systems (described in Section 3314) are typically required as the vessel reaches the very high latitudes, typically above about 85°N. Navigators must ensure that the INS is shifted to this mode and all understand the output of the information. Commercial INS may also function adequately at higher latitudes, but navigators should confirm their performance specification prior to entering the Arctic.

When operating in the Arctic, ships equipped with inertial navigation systems (INS) are required to switch to Transverse Mode to keep the INS solution from degrading when tangents approach zero and to make heading more useful. Transverse Mode is an alternative coordinate system which puts the virtual pole at the normal equator.

Heading, Velocity, and Position all change to Transverse Heading (THD), Transverse North and East Velocity (TNV/TEV), and Transverse Lat/Lon (TLT/TLN) when in Transverse Mode.

Military marine INS are designed to function at 90° N. The AN/WSN-7A RLGN has been successfully operated in the Arctic, and at the North Pole (using transverse mode) under a variety of conditions without faults, and it is expected that all future military INS will have similar capabilities.

3336. Global Navigation Satellite Systems (GNSS)

Global satellite navigation systems (GPS, GLONASS, Galileo, Beidou), are particularly useful in the Arctic because of the scarcity of aids of shorter range. Such short range aids as may be in existence are subject to damage or failure by ice or storms, or other causes. Ice and storm damage may be widespread and require considerable time to repair. Isolated damage may exist for a long time without being discovered and reported.

Some limitations of GNSS must be understood. Since the fielded GNSS are in orbit planes that are at an angle to the equator, GNSS will appear at reduced elevations. For example, GPS has 55 degree orbit planes, thus no satellite altitude higher than 35° degrees will be visible at the North pole. Galileo is similar at 56 degrees, but GLONASS is slightly better with a 65 degree orbit plane.

Because of GNSS receiver mask angles, lower altitude satellites may be removed from calculations; thus, there may be fewer satellites available to the navigator at any given time. Navigators may need to adjust altitude mask angle on receivers to increase number of available satellites, although this might add some increased uncertainty.

Low elevation angles in polar areas have the additional following impacts:

- low angles are good for the horizontal dilution of precision (HDOP), but bad for the vertical dilution of precision (VDOP)
- poorer altitude accuracy will be obtained
- Higher noise level in observations
- Larger ionospheric effects at lower elevation angles

Navigators must understand that there are sparse monitoring infrastructures by any of the GNSS or RF-based navigations systems including:

- Monitoring capability may be temporarily powered
- Poor real-time communication links
- Poor visibility of geostationary satellites
- Arctic area beyond reach of the Euro Geostationary Navigation Overlay Service (EGNOS) and the Wide Area Augmentation System (WAAS)
- GEO satellites low on horizon, visible only for brief periods

- No IALA differential beacons (300 kHz)
- Most RF communications are subject to ionosphere perturbations

If the datum used by the GPS receiver in calculating latitude and longitude is different from the datum of the chart in use, errors will occur when GPS derived positions are plotted on the chart. GPS receivers can be programmed to output latitude and longitude based on a variety of stored datums. The mariner must always ensure that the GPS position output is synchronized to the electronic or paper chart in use.

When GNSS satellite signals travel through the Earth's atmosphere, they are affected by the media of the RF transmission. In the ionosphere, the electromagnetic signals are affected mainly by free negatively charged electrons. The signals experience code delay and phase advance during the transition through the path.

The size of the effect on navigation is a function of the amount of electrons encountered by the signal, defined as the Total Electron Content (TEC). TEC is roughly correlated with the solar activity. The size of the signal delay is dependent on the frequency, i.e. different for GNSS frequencies. For example, it is reported that the typical signal delay causes an error on GPS L1 pseudo ranges of 5-15 meters during day time and 1-3 meters at night. These numbers are global averages with spatial and temporal variations dependent on the solar activity. In GNSS receivers and positioning algorithms the ionospheric effect should be handled by ionospheric models along with data collected from different frequencies and locations.

3337. GNSS Antennas

Antennas are another area of concern, as they can become ice fouled preventing reception, and should be deployed as high as possible to avoid multi-path RF reception problems. GNSS RF frequencies have reduced penetration power in water or ice.

3338. GPS Augmentation Systems

GPS receivers may have the ability to use augmentation systems, which can be either space-based augmentation systems (SBAS), such as Wide Area Augmentation System (WAAS), European Geostationary Navigation Overlay Service (EGNOS), and Multi-functional Satellite Augmentation System (MSAS), or terrestrial based augmentation systems like USCG's Differential GPS (DGPS).

For the SBAS systems, GPS correction data is trans-

mitted to navigation users via geostationary satellites (GEO) which are located in the geostationary orbit at the Equator. Thus, the satellites are visible very low on the horizon at high latitudes. SBAS data reception can be often noisy and unreliable, and north of 81° N the satellites are not visible at all. The quality of the correction information is a function of the relative position of the reference station to the vessel used to calculate the corrections. Ground stations are being added. There are also ground stations for EGNOS at Jan Mayen Island and Svalbard Island, and corrections may be available in the Barents Sea from Eurofix. Mariners should consult the respective providers for reference station coverage and estimated accuracy for the intended area of operations.

SBAS suffer by the same limitations caused by ionospheric activity as satellite based positioning and navigation systems. In situations with increased ionospheric activity where ionospheric SBAS corrections really are needed for the EGNOS or WAAS user, the transmission of corrections might be disrupted by ionospheric perturbations.

It is reported that DGPS is also available along the Northern Sea Route (NSR), while there are no known DGPS stations along the Northwest Passage (NWP).

3339. Loran / CHAYKA

At present there is no LORAN coverage available in the Arctic. There is Russian CHAYKA coverage (Russian equivalent to LORAN) in the western part of the NSR, but a CHAYKA receiver must be employed.

3340. Radio Beacons

Other electronic aids exist in parts of the Arctic, particularly along the NSR of Russia. As of 2013, 47 radio beacons were reported along the NSR. Two types are reported to be in use, one with a range of 100 nm and the other with a range of 150 nm. It is also reported that there are radar reflectors along the NSR coast.

3341. Sonar

Sonar is useful primarily for detecting ice, particularly growlers. Since approximately 50%-85% of the ice is under water, its presence can sometimes be detected by sonar when it is overlooked by radar or visual observation.

CELESTIAL NAVIGATION

3342. Celestial Navigation in High Latitudes

Of the various types of navigation, celestial is perhaps

least changed in polar regions. However, certain special considerations are applicable. Because of the limitations of other forms of navigation, as discussed earlier in this chapter, celestial navigation provides the principal means of determining geographical position. However, as indicated in Section 3328, position relative to nearby dangers is usually of more interest to the polar navigator than geographical position. Since ships in high latitudes are seldom far from land, and since celestial navigation is attended by several limitations, discussed in Section 3343, its use in marine navigation is generally confined to the following applications:

1. Navigation while proceeding to and from polar regions;
2. Verifying the accuracy of dead reckoning;
3. Verifying the accuracy of charted positions of landmarks, shoals, etc.; and,
4. Providing a directional reference, either by means of a celestial compass or by providing a means of checking the magnetic or gyrocompass.

Although its applications are limited, celestial navigation is important in high latitudes. Application 3 above, and application 4, even more so, can be of great value to the polar navigator.

3343. Celestial Observations

The best celestial fixes are usually obtained by star observations during twilight. As the latitude increases, these periods become longer, providing additional time for observation. But with this increase comes longer periods when the sun is just below the horizon and the stars have not yet appeared. During this period, which in the extreme condition at the pole lasts for several *days*, no celestial observations may be available. The moon is sometimes above the horizon during this period and bright planets, notably Venus and Jupiter, may be visible. With practice, the brighter stars can be observed when the sun is 20° to 30° below the horizon.

Beyond the polar circles the sun remains above the horizon without setting during part of the summer. The length of this period increases with latitude. At Thule, Greenland, about 10° inside the Arctic Circle, the sun remains above the horizon for four months. During this period of continuous daylight the sun circles the sky, changing azimuth about 15° each hour. A careful observation, or the average of several observations, each two hours provides a series of running fixes. An even better check on position is provided by making hourly observations and establishing the most probable position at each observation. Sometimes the moon is above the horizon, but within several days of the new or full phase it provides lines of position nearly parallel to the sun lines and hence of limited value in establishing fixes.

During the long polar night the sun is not available and

the horizon is often indistinct. However, the long twilight, a bright aurora, and other sources of polar light (Section 3305) shorten this period. By adapting their eyes to darkness, some navigators can make reasonably accurate observations throughout the polar night. The full moon in winter remains above the horizon more than half the time and attains higher altitudes than at other seasons.

In addition to the long periods of darkness in high latitudes, other conditions are sometimes present to complicate the problem of locating the horizon. During daylight the horizon is frequently obscured by low fog, frost smoke, or blowing snow, yet the sun may be clearly visible. Hummocked sea ice is sometimes a problem, particularly at low heights of eye. Nearby land or an extensive ice foot can also be troublesome. Extreme conditions of abnormal refraction are not uncommon in high latitudes, sometimes producing false horizons and always affecting the refraction and dip corrections.

Because of these conditions, it is advisable to be provided with an artificial horizon sextant (see Section 1415). This instrument is generally not used aboard ship because of the excessive acceleration error encountered as the ship rolls and pitches. However, in polar regions there is generally little such motion and in the ice there may be virtually none. Some practice is needed to obtain good results with an artificial-horizon sextant, but these results are sometimes superior to those obtainable with a marine sextant, and when some of the conditions mentioned above prevail, the artificial-horizon sextant may provide the only means of making an observation. Better results with this instrument can generally be obtained if the instrument is hung from some support, as it generally is when used in aircraft.

An artificial horizon, even an improvised one, (Section 1414) can sometimes be used effectively as by placing heavy lubricating oil in a bucket.

It is sometimes possible to make better observations by artificial-horizon sextant or artificial horizon from a nearby cake of ice than from the ship. Clouds and high fog are frequent in high latitudes, but it is not uncommon, particularly in the Antarctic, for the fog to lift for brief periods, permitting an alert navigator to obtain observations.

As the latitude increases, an error of time has less effect upon altitude. At the equator an error of 4 seconds in time may result in an error in the location of the position line of as much as 1 mile. At latitude 60° a position error of this magnitude cannot occur unless the timing error is 8 seconds. At 70° nearly 12 seconds are needed, and at 80° about 23 seconds are needed for such a position error.

Polaris is of diminished value in high northern latitudes because of its high altitude. At high latitudes the second correction to observed altitude (*al*) becomes greater. The almanac makes no provision for applying this beyond latitude 68°. Bodies at high altitudes are not desirable for azimuth determination, but if Polaris is used, the use of the actual azimuth given at the bottom of the Polaris tables of the *Nautical Almanac* is of increased importance because of

its larger variation from 000° in high latitudes. No azimuth is provided beyond latitude 65° .

In applying a sextant altitude correction for dip of the horizon, one should use height of eye *above the ice at the horizon*, instead of height above water. The difference between ice and water levels at the horizon can often be estimated by observing ice near the vessel.

3344. Low-Altitude observations

Because of large and variable refraction at low altitudes, navigators customarily avoid observations below some minimum, usually 5° to 15° , if higher bodies can be observed. In polar regions low-altitude observations are often the only ones available. The sun, moon, and planets remain low in the sky for relatively long periods, their diurnal motion being nearly horizontal. The only lower limit is that imposed by the horizon itself. In fact, good observations can sometimes be made without a sextant by noting the time at which either the upper or lower limb is tangent to the horizon. To such an observation sextant altitude corrections are applied as for a marine sextant without an index correction.

If a bubble or other artificial-horizon sextant is used, corrections are made as for higher altitudes, being careful to use the refraction value corrected for temperature, or to make a separate correction for air temperature. In addition, a correction for atmospheric pressure (Table 24) is applied if of sufficient size to be of importance.

3345. Abnormal Refraction and Dip

Tables of refraction correction are based upon a standard atmosphere. Variations in this atmosphere result in changes in the refraction, and since the atmosphere is seldom exactly standard, the mean refraction is seldom the same as shown in the tables. Variations from standard conditions are usually not great enough to be troublesome.

In polar regions, however, it is normal for the atmosphere to differ considerably from the standard, particularly near the surface. This affects both refraction and dip. Outside polar regions, variations in refraction seldom exceed 2' to 3', although extreme values of more than 30' have been encountered. In polar regions refraction variations of several minutes are not uncommon and an extreme value of about 5° has been reported. This would produce an error of 300 miles in a line of position. The sun has been known to rise as much as ten days before it was expected.

Most celestial observations in polar regions produce satisfactory results, but the high-latitude navigator should be on the alert for abnormal conditions, since they occur more often than elsewhere, and have greater extreme values. A wise precaution is to apply corrections for air temperature (Table 27) and atmospheric pressure (Table

28), particularly for altitudes of less than 5° .

Abnormal dip affects the accuracy of celestial observations equally at any altitude, if the visible horizon is used. Such errors may be avoided by using any one of four methods:

1. The artificial-horizon sextant may be used, as indicated in Section 3343.
2. When stars are available, three stars may be observed at azimuth intervals of approximately 120° , (or four at 90° intervals, five at 72° , etc.). Any error in dip *or refraction* will alter the size of the enclosed figure, but will not change the location of its center unless the dip or refraction error varies in different directions. The stars should preferably be at the same altitude.
3. The altitude of a single body may be observed twice, facing in opposite directions. The sum of the two readings differs from 180° by twice the sum of the index and dip corrections (also personal and instrument corrections, if present). This method assumes that dip is the same in both directions, an assumption that is usually approximately correct. Also, the method requires that the arc of the sextant be sufficiently long and the altitude of the body sufficiently great to permit observation of the back sight in the opposite direction. In making such observations, it is necessary that allowance be made for the change of altitude between readings. This may be done by taking a direct sight, a back sight, and then another direct sight at equal intervals of time, and using the average of the two direct sights.
4. A correction for the difference between air and sea temperatures may be applied to the sextant altitude. This will often provide reasonably good results. However, there is considerable disagreement in the manner in which temperature is to be measured, and in the factor to use for any given difference. Therefore, the validity of this correction is not fully established.

There is still much to be learned regarding refraction and even with all known precautions, results may occasionally be unsatisfactory.

3346. Sight Reduction

Sight reduction in polar regions is virtually the same as elsewhere. Computation can be made by nearly any method, or by use of common computer applications. One special method of considerable interest is applicable only within about 5° of the pole, a higher latitude than is usually attainable by ships. This is the method of using the pole as the assumed position. At this point the zenith and pole coincide and hence the celestial equator and celestial horizon also coincide, and the systems of coordinates based upon

these two great circles of the celestial sphere become identical. The declination is computed altitude, and GHA replaces azimuth. A “toward” altitude intercept is plotted along the upper branch of the meridian over which the body is located, and an “away” intercept is plotted in the opposite direction, along the lower branch. Such a line or its AP is advanced or retired in the usual manner. This method is a special application of the meridian altitude sometimes used in lower latitudes. Beyond the limits of this method the meridian altitude can be used in the usual manner without complications and with time of transit being less critical. However, Table 24, for reduction to the meridian, extends only to latitude 60°.

3347. Manual Plotting of LOPs

Lines of position from celestial observations in polar regions are plotted as elsewhere, using an assumed position, altitude intercept, and azimuth. If a paper Mercator chart is used, the error introduced by using rhumb lines for the azimuth line (a great circle) and line of position (a small circle) is accentuated. This can be overcome by using a chart on a more favorable projection.

If a chart with nonparallel meridians, such as the Lambert conformal, is used, the true azimuth should be plotted by protractor or plotter and measured at the meridian of the assumed position. On a chart having a grid overprint the true azimuth can be converted to grid azimuth, using the longitude of the assumed position, and the direction measured from any grid line. This method involves an additional step, with no real advantage.

Lines of position from high-altitude observations, to be plotted as circles with the geographical position as the center, should not be plotted on a paper Mercator chart because of the rapid change of scale, resulting in distortion of the circle as plotted on the chart.

Lines of position are advanced or retired as in any latitude. However, the movement of the line is no more accurate than the estimate of the direction and distance traveled, and in polar regions this estimate may be of less than usual accuracy. In addition to the problem of estimated direction of travel, the polar navigator may encounter difficulty in accurately plotting the direction determined. If an accurate gyrocompass is used, the ship follows a rhumb

line, which is accurately shown only on a Mercator chart. If a magnetic compass is used, the rapid change in variation may be a disturbing factor. If the ship is in ice, the course line may be far from straight.

Because of the various possible sources of error involved, it is good practice to avoid advancing or retiring lines for a period longer than about two hours. When the sun is the only body available, best results can sometimes be obtained by making an observation every hour, retiring the most recent line one hour and advancing for one hour the line obtained two hours previously. The present position is then obtained by dead reckoning from the running fix of an hour before. Another technique is to advance the one or two previous lines to the present time for a running fix. A third method is to drop a perpendicular from the dead reckoning or estimated position to the line of position to obtain a new estimated position, from which a new dead reckoning plot is carried forward to the time of the next observation. A variation of this method is to evaluate the relative accuracy of the new line of position and the dead reckoning or estimated position run up from the previous position and take some point between them, halfway if no information is available on which to evaluate the relative accuracies. None of these techniques is suitable for determining set and drift of the current.

3348. Rising, Setting and Twilight

Rising, setting, and twilight data are tabulated in the almanacs to latitude 72°N and 60°S. Within these limits the times of these phenomena are determined as explained in Chapter 17, The Almanacs.

Beyond the northern limits of these tables the values can be obtained from a series of graphs given near the back of the Air Almanac. For high latitudes, graphs are used instead of tables because graphs give a clearer picture of conditions, which may change radically with relatively little change in position or date. Under these conditions interpolation to practical precision is simpler by graph than by table. In those parts of the graph which are difficult to read, the times of the phenomena's occurrence are themselves uncertain, being altered considerably by a relatively small change in refraction or height of eye. The use of the graphs is explained in Chapter 17, The Almanacs.

SUMMARY

3349. Knowledge of Polar Regions

Operations in polar regions are attended by hazards and problems not encountered elsewhere. Lack of knowledge, sometimes accompanied by fear of the unknown, has prevented navigation in these areas with the same confidence that is pursued in more familiar areas. As experience in high latitudes has increased, much of the mystery surrounding these areas has been dispelled, and operations

have become more predictable.

Before entering polar regions, navigators will do well to acquaint themselves with the experience of those who have preceded them into the areas and under the conditions they anticipate. This information can be found in the growing literature composed from the accounts of explorers, reports of previous operations in high latitudes, articles in professional journals, and several books on operations in polar regions. Some of it is published in various volumes of

sailing directions.

The search for knowledge should not be confined to navigation. The wise polar navigator will seek information on living conditions, survival, geography, ice, climate and weather, and operational experience of others who have been to the same area. As elsewhere, knowledge and experience are valuable. The Encyclopedia of the Arctic (3 Volumes), Mark Nuttall Editor is the reference for all things “arctic” from Archaeology to Zagoskin (ie Lavrentii Zagoskin), and includes chapters on weather, wildlife, politics, history, oceanography, environment and indigenous peoples.

3350. Planning

Planning, important in any operation, is vital to the success of polar navigation. The first step to adequate planning is the acquisition of full knowledge, as discussed in Section 3349. No item, however trivial, should escape attention. The ship should be provided with all the needed charts, publications, and special navigational material. All available data and information from previous operations in the area should be studied. Key personnel should be adequately instructed in polar navigation prior to departure or while en-route to the polar regions. Forecasts on anticipated ice and weather conditions should be obtained before getting under way. All equipment should be in top operating condition.

All material should be carefully inspected for completeness and accuracy. The navigator should make certain that all items of equipment are familiar to those who will use them. This is particularly true of items not generally used at sea, such as charts on an unfamiliar projection, or a bubble sextant. Do not assume anything that can be known. Successful polar navigation depends on adequate and thorough advanced planning and preparation.

3351. References

Ice Navigation in Canadian Waters. Canada (<http://www.ccg-gcc.gc.ca/folios/00913/docs/ice-navigation-dans-les-galces-eng.pdf>)

Kierstad, N., (2011) *Ice Navigation*. Trondheim: Tapir Academic.

Ostreg, W., et al, (2013). *Shipping in Arctic Waters*. Springer Praxis Books.

Pearson, F., (1990). *Map Projections: Theory and Application*, CRC Press.

Skopeliti, A., et al, (2013). *Choosing a Suitable Projection for Navigation in the Arctic*. Retrieved from http://www.iho.int/mtg_docs/rhc/ArHC/ArHC3/ARHC3-3.2.7_Suitable_projections_for_the_Arctic.pdf

CHAPTER 34

THE OCEANS

INTRODUCTION

3400. The Importance of Oceanography

Oceanography is the scientific study of the oceans. It includes a study of their physical, chemical, and geological forms, and biological features. It embraces the widely separated fields of geography, geology, chemistry, physics, and biology, along with their many subdivisions, such as sedimentation, ecology, bacteriology, biochemistry, hydrodynamics, acoustics, and optics.

The oceans cover 70.8 percent of the surface of the Earth. The Atlantic covers 16.2 percent, the Pacific 32.4 percent (3.2 percent more than the land area of the entire Earth), the Indian Ocean 14.4 percent, and marginal and adjacent areas (of which the largest is the Arctic Ocean) 7.8 percent. Their extent alone makes them an important subject for study. However, greater incentive lies in their use for transportation, their influence upon weather and climate, and their potential as a source of power, food, fresh water, minerals, and organic substances.

3401. Origin of the Oceans

The structure of the continents is fundamentally different

from that of the oceans. The rocks underlying the ocean floors are more dense than those underlying the continents. According to one theory, all the Earth's crust floats on a central liquid core, and the portions that make up the continents, being lighter, float with a higher freeboard. Thus, the thinner areas, composed of heavier rock, form natural basins where water has collected.

The shape of the oceans is constantly changing due to continental drift. The surface of the Earth consists of many different "plates." These plates are joined along **fracture** or **fault lines**. There is constant and measurable movement of these plates at rates of 0.02 meters per year or more.

The origin of the water in the oceans is unclear. Although some geologists have postulated that all the water existed as vapor in the atmosphere of the primeval Earth, and that it fell in great torrents of rain as soon as the Earth cooled sufficiently, another school holds that the atmosphere of the original hot Earth was lost, and that the water gradually accumulated as it was given off in steam by volcanoes, or worked to the surface in hot springs.

Most of the water on the Earth's crust is now in the oceans—about 1,370,000,000 cubic kilometers, or about 85%. The mean depth of the ocean is 3,795 meters, and the total area is 360,000,000 square kilometers.

CHEMISTRY OF THE OCEANS

3402. Chemical Description

Oceanographic chemistry may be divided into three main parts: the chemistry of (1) seawater, (2) marine sediments, and (3) organisms living in the sea. The first is of particular interest to the navigator.

Chemical properties of seawater are usually determined by analyzing samples of water obtained at various locations and depths. Samples of water from below the surface are obtained with special bottles designed for this purpose. The open bottles are mounted in a **rosette** which is attached to the end of a wire cable which contains insulated electrical wires. The rosette is lowered to the depth of the deepest sample, and a bottle is closed electronically (see Figure 3402). As the rosette is raised to the surface, other bottles are closed at the desired depths. Sensors have also been developed to measure a few chemical properties of sea water continuously.

Physical properties of seawater are dependent

primarily upon salinity, temperature, and pressure. However, factors like motion of the water and the amount of suspended matter affect such properties as color and transparency, conduction of heat, absorption of radiation, etc.

3403. Salinity

Salinity is a measure of the amount of dissolved solid salts material in the water. Salts are compounds like sodium chloride and potassium nitrate. The units to express salinity have changed over the years. Up to the 1980s, salinity was measured by titration and expressed as parts per thousand (ppt or ‰). After 1980, the **practical salinity unit (psu)**, measured by electrical conductivity, was used. Starting in 2010 the thermodynamic equation of seawater with units of grams per kilogram of solution began to be employed. A sample of seawater with a salinity of 35.00 ‰, would have a psu of 35.00, and in the newest system would have a value



Figure 3402. CTD Rosette is lowered to measure the salinity, temperature, depth and concentration of particles in the water column. Image courtesy of NOAA.

of 35.2 g/kg.

In 2016, the most common scale employed is the **practical salinity unit**. Using this scale, the salinity of a seawater sample is defined as the ratio between the conductivity of the sample and the conductivity of a standard potassium chloride (KCl) sample.

Salinity generally varies between about 33 and 37 psu. However, when the water has been diluted, as near the mouth of a river or after a heavy rainfall, the salinity is somewhat less; and in areas of excessive evaporation, the salinity may be as high as 40 psu. In certain confined bodies of water, notably the Great Salt Lake in Utah, and the Dead Sea in Asia Minor, the salinity is several times this maximum.

3404. Temperature

Temperature in the ocean varies widely, both horizontally and with depth. Maximum values of about 32°C are encountered at the surface in the Persian Gulf in summer, and the lowest possible values of about -2°C (the usual minimum freezing point of seawater) occur in polar regions.

Except in the polar regions, the vertical distribution of temperature in the sea in the majority of the seas show a decrease of temperature with depth. Since colder water is denser (assuming the same salinity), it sinks below warmer water. This results in a temperature distribution just opposite to that of the Earth's crust, where temperature increases with depth below the surface of the ground.

In the sea there is usually a mixed layer of isothermal water below the surface, where the temperature is the same as that of the surface. This layer is caused by two physical processes: wind mixing and convective overturning. As surface water cools it becomes more dense. This layer is best developed in the Arctic and Antarctic regions, and in seas like the Baltic and Sea of Japan during the winter, where it may extend to the bottom of the ocean. In the Tropics, the wind-mixed layer may exist to a depth of 125 meters, and may exist throughout the year. Below this layer is a zone of rapid temperature decrease, called the **thermocline**. At a depth greater than 400 meters, the temperature is below 15°C. In the deeper layers, fed by cooled waters that have sunk from the surface in the Arctic and Antarctic, temperatures as low as -2°C exist.

In the colder regions, the cooling creates the convective overturning and isothermal water in the winter; in the summer, a seasonal thermocline is created as the upper water becomes warmer. A typical curve of temperature at various depths is shown in Figure 3410a. Temperature is commonly measured with either a platinum or copper resistance thermometer or a thermistor (devices that measure the change in conductivity of a semiconductor with change in temperature).

The **CTD (conductivity-temperature-depth)** is an instrument that generates continuous signals as it is lowered into the ocean; temperature is determined by means of a platinum resistance thermometer, salinity by conductivity, and depth by pressure. These signals can be transmitted to the surface through a cable and recorded, or recorded internally. Accuracy of temperature measurement is 0.005°C and resolution an order of magnitude better (see Figure 3402).

A method commonly used to measure upper ocean temperature profiles from a vessel which is underway is the **expendable bathythermograph (XBT)**. The XBT uses a thermistor and is connected to the vessel by a fine wire. The wire is coiled inside the probe; as the probe free-falls in the ocean, the wire pays out. Depth is determined by elapsed time and a known sink rate. Depth range is determined by the amount of wire stored in the probe; the most common model has a depth range of 450 meters. At the end of the drop, the wire breaks and the probe falls to the ocean bottom. One instrument of this type is dropped from an aircraft; the data is relayed to the aircraft from a buoy to which the wire of the XBT is attached. The accuracy and precision of an XBT is about 0.1°C.

3405. Pressure

The appropriate international standard (SI) unit for pressure in oceanography is 1 $kPa = 10^3 Pa$ where Pa is a Pascal and is equal to one Newton per square meter. A more commonly used unit is a bar, which is nearly equal to 1 atmosphere (atmospheric pressure is measured with a barometer and may be read as hectopascals). Water

pressure is expressed in terms of decibars, 10 of these being equal to 1 bar. One decibar is equal to nearly $1\frac{1}{2}$ pounds per square inch. This unit is convenient because it is very nearly the pressure exerted by 1 meter of water. Thus, the pressure in decibars is approximately the same as the depth in meters, the unit of depth.

Although virtually all of the physical properties of seawater are affected to a measurable extent by pressure, the effect is not as great as those of salinity and temperature. Pressure is of particular importance to submarines, directly because of the stress it induces on the hull and structures, and indirectly because of its effect upon buoyancy.

3406. Density

Density is mass per unit of volume. The appropriate SI unit is kilograms per cubic meter. The density of seawater depends upon salinity, temperature, and pressure. At constant temperature and pressure, density varies with salinity. A temperature of 0°C and atmospheric pressure are considered standard for density determination. The effects of thermal expansion and compressibility are used to determine the density at other temperatures and pressures. Slight density changes at the surface generally do not affect the draft or trim of a ship, though a noticeable change may occur as a ship travels from salt to fresh water. Density changes at a particular subsurface pressure will affect the buoyancy of submarines because they are ballasted to be neutrally buoyant. For oceanographers, density is important because of its relationship to ocean currents.

Open ocean values of density range from about 1,021 kilograms per cubic meter at the surface to about 1,070 kilograms per cubic meter at 10,000 meters depth. As a matter of convenience, it is usual in oceanography to define a density anomaly which is equal to the density minus 1,000 kilograms per cubic meter. Thus, when an oceanographer speaks of seawater with a density of 25 kilograms per cubic meter, the actual density is 1,025 kilograms per cubic meter.

The greatest changes in density of seawater occur at the surface, where the water is subject to influences not present at depths. At the surface, density is decreased by precipitation, run-off from land, melting ice, or heating. When the surface water becomes less dense, it tends to float on top of the denser water below. There is little tendency for the water to mix, and so the condition is one of stability. The density of surface water is increased by evaporation, formation of sea ice, and by cooling. If the surface water becomes more dense than that below, convection currents cause vertical mixing. The denser surface water sinks and mixes with less dense water below. The resultant layer of water is of intermediate density. This process continues until the density of the mixed layer becomes less than that of the water below. The convective circulation established as part of this process can create very deep uniform mixed layers.

If the surface water becomes sufficiently dense, it sinks

all the way to the bottom. If this occurs in an area where horizontal flow is unobstructed, the water which has descended spreads to other regions, creating a dense bottom layer. Since the greatest increase in density occurs in polar regions, where the air is cold and great quantities of ice form, the cold, dense polar water sinks to the bottom and then spreads to lower latitudes. In the Arctic Ocean region, the cold, dense water is confined by the Bering Strait and the underwater ridge from Greenland to Iceland to Europe. In the Antarctic, however, there are no similar geographic restrictions and large quantities of very cold, dense water formed there flow to the north along the ocean bottom. This process has continued for a sufficiently long period of time; the entire ocean floor is covered with this dense water, thus explaining the layer of cold water at great depths in all the oceans.

In some respects, oceanographic processes are similar to those occurring in the atmosphere. Masses of water of uniform characteristics are analogous to air masses.

3407. Compressibility

Seawater is nearly incompressible, its coefficient of compressibility being only 0.000046 per bar under standard conditions. This value changes slightly with changes in temperature or salinity. The effect of compression is to force the molecules of the substance closer together, causing it to become more dense. Even though the compressibility is low, its total effect is considerable because of the amount of water involved. If the compressibility of seawater were zero, sea level would be about 90 feet higher than it is now.

Compressibility is inversely proportional to temperature, i.e., cold water is more compressible than warm water. Waters which flow into the North Atlantic from the Mediterranean and Greenland Seas are equal in density, but because the water from the Greenland Sea is colder, it is more compressible and therefore becomes denser at depth. These waters from the Greenland Sea are therefore found beneath those waters which derive their properties from the Mediterranean.

3408. Viscosity

Viscosity is resistance to flow. Seawater is slightly more viscous than freshwater. Its viscosity increases with greater salinity, but the effect is not nearly as marked as that occurring with decreasing temperature. The rate is not uniform, becoming greater as the temperature decreases. Because of the effect of temperature upon viscosity, an incompressible object might sink at a faster rate in warm surface water than in colder water below. However, for most objects, this effect may be more than offset by the compressibility of the object.

The actual relationships existing in the ocean are considerably more complex than indicated by the simple explanation here, because of turbulent motion within the

sea. The effect of disturbing the water is called **eddy viscosity**.

3409. Specific Heat

Specific heat is the amount of heat required to raise the temperature of a unit mass of a substance a stated amount. In oceanography, specific heat is stated, in SI units, as the number of Joules needed to raise 1 kilogram of a given substance 1°C. Specific heat at constant pressure is usually the quantity desired when liquids are involved, but occasionally the specific heat at constant volume is required. The ratio of these two quantities is directly related to the speed of sound in seawater.

The specific heat of seawater decreases slightly as salinity increases. However, it is much greater than that of land. The ocean is a giant storage area for heat. It can absorb large quantities of heat with very little change in temperature. This is partly due to the high specific heat of water and partly due to mixing in the ocean that distributes the heat throughout a layer. Land has a lower specific heat and, in addition, all heat is lost or gained from a thin layer at the surface; there is no mixing. This accounts for the greater temperature range of land and the atmosphere above it, resulting in monsoons, and the familiar land and sea breezes of tropical and temperate regions.

3410. Sound Speed

The speed of sound in sea water is a function of its density, compressibility and, to a minor extent, the ratio of specific heat at constant pressure to that at constant volume. As these properties depend on the temperature, salinity and pressure (depth) of sea water, it is customary to relate the speed of sound directly to the water temperature, salinity and pressure. An increase in any of these three properties causes an increase in the sound speed; the converse is true also. Figure 3410a portrays typical mid-ocean profiles of temperature and salinity; the resultant sound speed profile is shown in Figure 3410b.

The speed of sound changes by 3 to 5 meters per second per °C temperature change, by about 1.3 meters per second per psu salinity change and by about 1.7 meters per second per 100 m depth change. A simplified formula adapted from Wilson's (1960) equation for the computation of the sound speed in sea water is:

$$U = 1449 + 4.6T - 0.055T^2 + 0.0003T^3 + 1.39(S - 35) + 0.017D$$

where U is the speed (m/s), T is the temperature (°C), S is the salinity (psu), and D is depth (m).

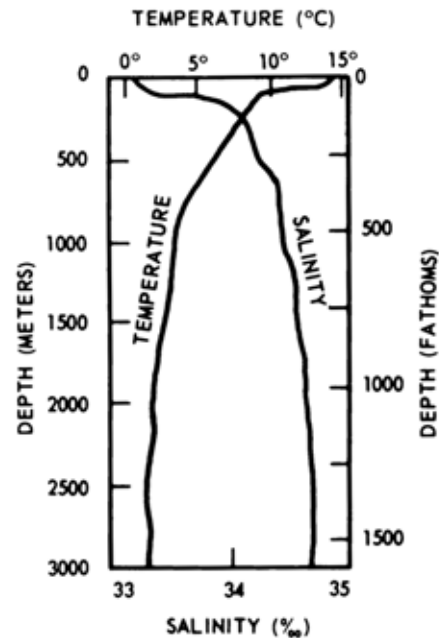

Figure 3410a. Typical variation of temperature and salinity with depth for a mid-latitude location.

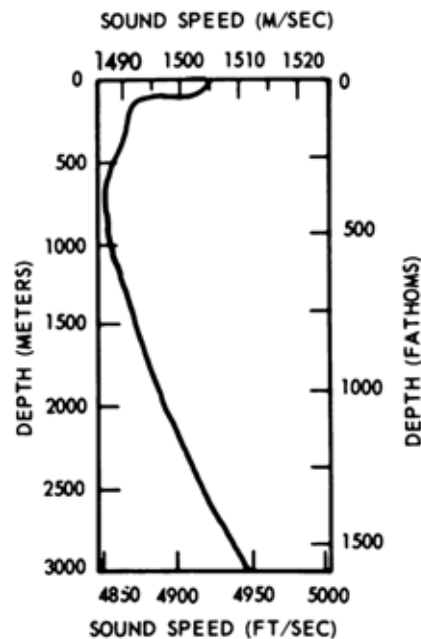

Figure 3410b. Resultant sound speed profile based on the temperature and salinity profile in Figure 3410a.

3411. Thermal Expansion

One of the more interesting differences between salt and fresh water relates to thermal expansion. Saltwater continues to become more dense as it cools to the freezing point; freshwater reaches maximum density at

4°C and then expands (becomes less dense) as the water cools to 0°C and freezes. This means that the convective mixing of freshwater stops at 4°C; freezing proceeds very rapidly beyond that point. The rate of expansion with increased temperature is greater in seawater than in fresh water. Thus, at temperature 15°C, and atmospheric pressure, the coefficient of thermal expansion is 0.000151 per degree Celsius for freshwater, and 0.000214 per degree Celsius for average seawater. The coefficient of thermal expansion increases not only with greater salinity, but also with increased temperature and pressure. At a salinity of 35 psu, the coefficient of surface water increases from 0.000051 per degree Celsius at 0°C to 0.000334 per degree Celsius at 31°C. At a constant temperature of 0°C and a salinity of 34.85 psu, the coefficient increases to 0.000276 per degree Celsius at a pressure of 10,000 decibars (a depth of approximately 10,000 meters).

3412. Thermal Conductivity

In water, as in other substances, one method of heat transfer is by conduction. Freshwater is a poor conductor of heat, having a coefficient of thermal conductivity of 582 Joules per second per meter per degree Celsius. For seawater it is slightly less, but increases with greater temperature or pressure.

However, if turbulence is present, which it nearly always is to some extent, the processes of heat transfer are altered. The effect of turbulence is to increase greatly the rate of heat transfer. The “eddy” coefficient used in place of the still-water coefficient is many times larger, and so dependent upon the degree of turbulence, that the effects of temperature and pressure are not important.

3413. Electrical Conductivity

Water without impurities is a very poor conductor of electricity. However, when salt is in solution in water, the salt molecules are ionized and become carriers of electricity. (What is commonly called freshwater has many impurities and is a good conductor of electricity; only pure distilled water is a poor conductor.) Hence, the electrical conductivity of seawater is directly proportional to the number of salt molecules in the water. For any given salinity, the conductivity increases with an increase in temperature.

3414. Radioactivity

Although the amount of radioactive material in seawater is very small, this material is present in marine sediments to a greater extent than in the rocks of the Earth's crust. This is probably due to precipitation of radium or other radioactive material from the water. The radioactivity of the top layers of sediment is less than that of deeper

layers. This may be due to absorption of radioactive material in the soft tissues of marine organisms.

3415. Transparency

The two basic processes that alter the underwater distribution of light are absorption and scattering. Absorption is a change of light energy into other forms of energy; scattering entails a change in direction of the light, but without loss of energy. If seawater were purely absorbing, the loss of light with distance would be given by $I_x = I_0 e^{-ax}$ where I_x is the intensity of light at distance x , I_0 is the intensity of light at the source, and “a” is the absorption coefficient in the same units with which distance is measured. In a pure scattering medium, the transmission of light is governed by the same power law, only in this case the exponential term is $I_0 e^{-bx}$, where “b” is the volume scattering coefficient. The attenuation of light in the ocean is defined as the sum of absorption and scattering so that the attenuation coefficient, c , is given by $c = a + b$. In the ocean, the attenuation of light with depth depends not only on the wavelength of the light but also the clarity of the water. The clarity is mostly controlled by biological activity although at the coast, sediments transported by rivers or resuspended by wave action can strongly attenuate light.

Attenuation in the sea is measured with a **transmissometer**. Transmissometers measure the attenuation of light over a fixed distance using a monochromatic light source which is close to red in color. Transmissometers are designed for in situ use and are usually attached to a CTD.

Since sunlight is critical for almost all forms of plant life in the ocean, oceanographers developed a simple method to measure the penetration of sunlight in the sea using a white disk 31 centimeters (a little less than 1 foot) in diameter which is called a **Secchi disk** (see Figure 3415a). This is lowered into the sea, and the depth at which it disappears is recorded. In coastal waters the depth varies from about 5 to 25 meters. Offshore, the depth is usually about 45 to 60 meters. The greatest recorded depth at which the disk has disappeared is 79 meters in the eastern Weddell Sea. These depths, D , are sometimes reported as a diffuse attenuation (or “extinction”) coefficient, k , where $k = 1.7/D$ and the penetration of sunlight is given by $I_z = I_0 e^{-kz}$, where z is depth and I_0 is the energy of the sunlight at the ocean's surface.

3416. Color

The color of seawater varies considerably. Water of the Gulf Stream is a deep indigo blue, while a similar current off Japan was named Kuroshio (Black Stream) because of the dark color of its water. Along many coasts the water is green. In certain localities a brown or brownish-red water has been observed. Colors other than blue are caused by biological sources, such as plankton, or by suspended sediments from river runoff.



Figure 3415a. A Secchi disk is used to measure sunlight penetration through the water.

Offshore, some shade of blue is common, particularly in tropical or subtropical regions. It is due to scattering of sunlight by minute particles suspended in the water, or by molecules of the water itself. Because of its short wavelength, blue light is more effectively scattered than light of longer waves. Thus, the ocean appears blue for the same reason that the sky does. The green color often seen near the coast is a mixture of the blue due to scattering of light and a stable soluble yellow pigment associated with phytoplankton. Brown or brownish-red water receives its color from large quantities of certain types of **algae**, microscopic plants in the sea, or from river runoff.

3417. Bottom Relief

Compared to land, relatively little is known of relief below the surface of the sea. The development of an effective echo sounder in 1922 greatly simplified the determination of bottom depth. Later, a recording echo sounder was developed to permit the continuous tracing of a bottom profile. The latest sounding systems employ an array of echosounders aboard a single vessel, which continuously sound a wide swath of ocean floor. This has contributed immensely to our knowledge of bottom relief. Beginning in the 1980's, satellite altimeters were launched, providing a global 'view' of the ocean's bathymetry. By these means, many undersea mountain ranges, volcanoes, rift valleys, and other features have been discovered.

Along most of the coasts of the continents, the bottom slopes gradually to a depth of about 130 meters or somewhat less, where it falls away more rapidly to greater depths. This **continental shelf** averages about 65 kilometers in width, but varies from the shoreline to about 1400 kilometers, the widest area being off the Siberian Arctic coast. A similar shelf extending outward from an island or group of islands is called an **island shelf**. At the outer edge of the shelf, the steeper slope of 2° to 4° is called the **continental slope**, or the **island slope**, according to whether it surrounds a continent or a group of islands. The shelf itself is not uniform, but has numerous hills, ridges, terraces, and canyons, the largest being comparable in size to the Grand Canyon.

The relief of the ocean floor is comparable to that of land. Both have steep, rugged mountains, deep canyons, rolling hills, plains, etc. Most of the ocean floor is considered to be made up of a number of more-or-less circular or oval depressions called **basins**, surrounded by walls (**sills**) of lesser depth.

A wide variety of submarine features have been identified and defined. Some of these are shown in Figure 3417. The term **deep** may be used for a very deep part of the ocean, generally that part deeper than 6,000 meters.

The average depth of water in the oceans is 3795 meters (2,075 fathoms), as compared to an average height of land above the sea of about 840 meters. The greatest known depth is 11,524 meters, in the Marianas Trench in the Pacific. The highest known land is Mount Everest, 8,840 meters. About 23 percent of the ocean is shallower than 3,000 meters, about 76 percent is between 3,000 and 6,000 meters, and a little more than 1 percent is deeper than 6,000 meters.

3418. Marine Sediments

The ocean floor is composed of material deposited through the ages. This material consists principally of (1) earth and rocks washed into the sea by streams and waves,

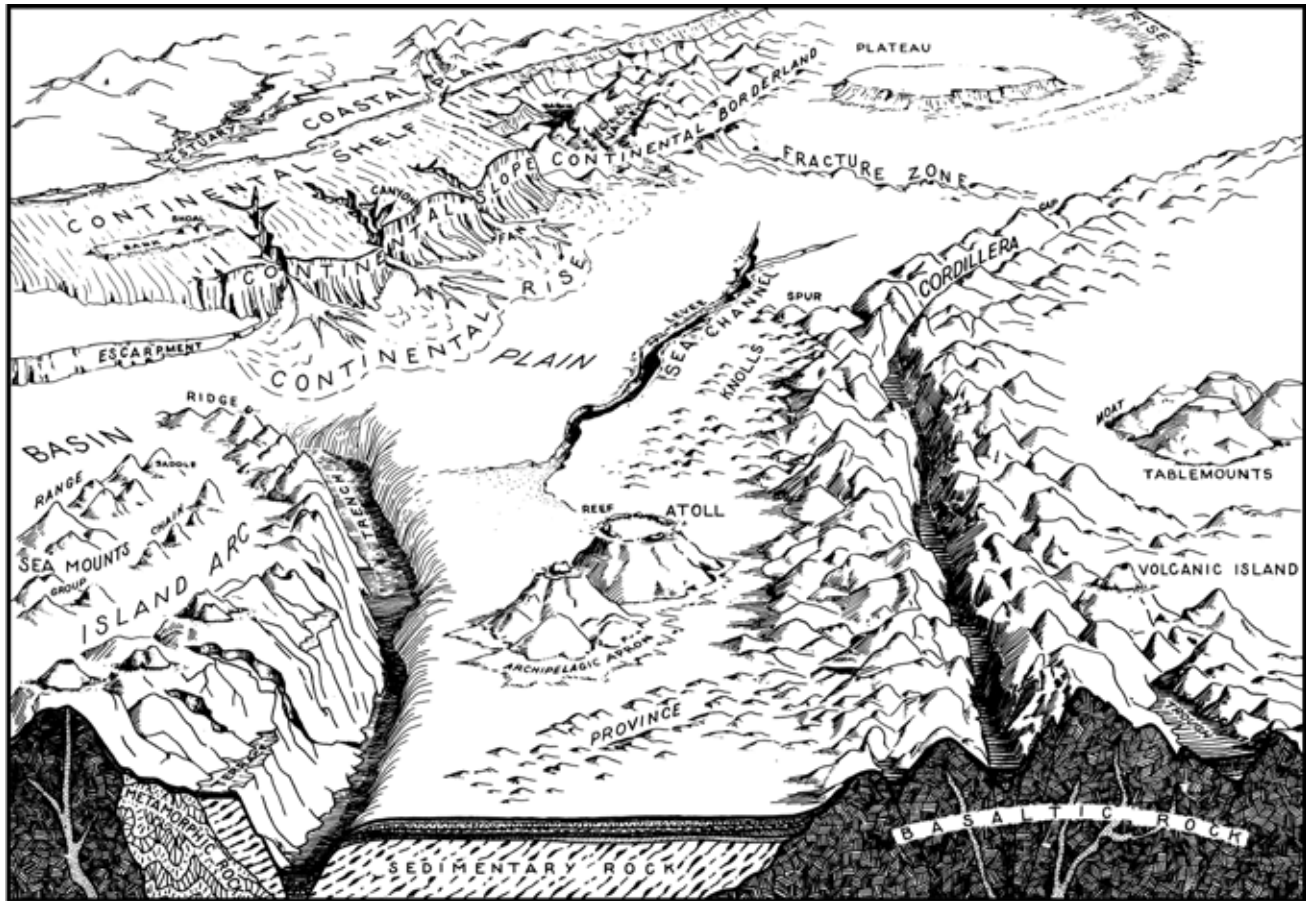

Figure 3417. Ocean basin features.

(2) volcanic ashes and lava, and (3) the remains of marine organisms. Lesser amounts of land material are carried into the sea by glaciers, blown out to sea by wind, or deposited by chemical means. This latter process is responsible for the **manganese nodules** that cover some parts of the ocean floor. In the ocean, the material is transported by ocean currents, waves, and ice. Near shore the material is deposited at the rate of about 8 centimeters in 1,000 years, while in the deep water offshore the rate is only about 1 centimeter in 1,000 years. Marine deposits in water deep enough to be relatively free from wave action are subject to little erosion. Recent studies have shown that some bottom currents are strong enough to move sediments. There are **turbidity currents**, similar to land slides, which move large masses of sediments. Turbidity currents have been known to rip apart large transoceanic cables on the ocean bottom. Because of this and the slow rate of deposit, marine sediments provide a better geological record than does the land.

Marine sediments are composed of individual particles of all sizes from the finest clay to large boulders. In general, the inorganic deposits near shore are relatively coarse (sand, gravel, shingle, etc.), while those in deep

water are much finer (clay). In some areas the siliceous remains of marine organisms or calcareous deposits of either organic or inorganic origin predominate on the ocean floor.

A wide range of colors is found in marine sediments. The lighter colors (white or a pale tint) are usually associated with coarse-grained quartz or limestone deposits. Darker colors (red, blue, green, etc.) are usually found in mud having a predominance of some mineral substance, such as an oxide of iron or manganese. Black mud is often found in an area that is little disturbed, such as at the bottom of an inlet or in a depression without free access to other areas.

Marine sediments are studied primarily through bottom samples. Samples of surface deposits are obtained by means of a "snapper" (for mud, sand, etc.) or "dredge" (usually for rocky material). If a sample of material below the bottom surface is desired, a "coring" device is used. This device consists essentially of a tube driven into the bottom by weights or explosives. A sample obtained in this way preserves the natural order of the various layers. Samples of more than 100 feet in depth have been obtained using coring devices.

3419. Satellite Oceanography

Weather satellites are able to observe ocean surface temperatures in cloud free regions by using infrared sensors. Although these sensors are only able to penetrate a few millimeters into the ocean, the temperatures that they yield are representative of upper ocean conditions except when the air is absolutely calm during daylight hours. For cloud covered regions, it is usually possible to wait a few days for the passage of a cold front and then use a sequence of infrared images to map the ocean temperature over a region. The patterns of warm and cold water yield information on ocean currents, the existence of fronts and eddies, and the temporal and spatial scales of ocean processes.

Other satellite sensors are capable of measuring ocean color, ice coverage, ice age, ice edge, surface winds and seas, ocean currents, and the shape of the surface of the ocean. (The latter is controlled by gravity and ocean circulation patterns. See Chapter 2.) The perspective provided by these satellites is a global one and in some cases they yield sufficient quantities of data that synoptic charts of the ocean surface, similar to weather maps and pilot charts, can be provided to the mariner for use in navigation.

The accuracy of satellite observations of the ocean surface depends, in many cases, on calibration procedures, which use observations of sea surface conditions provided by mariners. These observations include marine weather observations, expendable bathythermograph soundings, and currents measured by electromagnetic logs or acoustic Doppler current profilers. Care and diligence in these observations will improve the accuracy and the quality of satellite data.

3420. Synoptic Oceanography

Oceanographic data provided by ships, buoys, and

satellites are analyzed by the Naval Oceanographic Office (NAVO), the National Oceanic and Atmospheric Administration (NOAA) and NOAA's National Weather Service. This data is utilized in computer models both to provide a synoptic view of ocean conditions and to predict how these conditions will change in the future. These products are available to the mariner via radio or satellite.

The Naval Oceanographic Portal may be accessed through the following link (see Figure 3420).



Figure 3420. Naval Oceanographic Portal
<https://metoc.ndbc.noaa.gov/web/guest/navo>

3421. References

IOC, SCOR, and IAPSO (2010). *The international thermodynamic equation of seawater - 2010: Calculation and use of thermodynamic properties*. Intergovernmental Oceanographic Commission, UNESCO (English). pp. 196.

Smith, W. and Sandwell, D., (26 SEPTEMBER 1997) SCIENCE, Vol. 277. *Global Sea Floor Topography from Satellite Altimetry and Ship Depth Soundings*. pp. 1956-1962.

UNESCO (1981). *The Practical Salinity Scale 1978 and the International Equation of State of Seawater 1980*. Tech. Pap. Mar. Sci., 36.

CHAPTER 35

TIDES AND TIDAL CURRENTS

ORIGINS OF TIDES

3500. Introduction

Tides are the periodic motion of the waters of the sea due to changes in the attractive forces of the Moon and Sun upon the rotating Earth. Tides can either help or hinder a mariner. A high tide may provide enough depth to clear a bar, while a low tide may prevent entering or leaving a harbor. Tidal current may help progress or hinder it, may set the ship toward dangers or away from them. By understanding tides and making intelligent use of predictions published, the navigator can plan an expeditious and safe passage through tidal waters.

3501. Tide and Current

The rise and fall of tide is accompanied by horizontal movement of the water called tidal current. It is necessary to distinguish clearly between tide and tidal current, for the relation between them is complex and variable. For the sake of clarity mariners have adopted the following definitions: Tide is the vertical rise and fall of the water, and tidal current is the horizontal flow. The tide rises and falls, the tidal current floods and ebbs. The navigator is concerned with the amount and time of the tide, as it affects access to shallow ports. The navigator is concerned with the time, speed, and direction of the tidal current, as it will affect his ship's position, speed, and course.

Tides are superimposed on nontidal rising and falling water levels, caused by weather, seismic events, or other natural forces. Similarly, tidal currents are superimposed upon non-tidal currents such as normal river flows, floods, and freshets.

3502. Causes of Tides

The principal tidal forces are generated by the Moon and Sun. The Moon is the main tide-generating body. Due to its greater distance, the Sun's effect is only 46 percent of the Moon's. Observed tides will differ considerably from the tides predicted by equilibrium theory because size, depth, and configuration of the basin or waterway, friction, land masses, inertia of water masses, Coriolis acceleration, and other factors are neglected in this theory. Nevertheless, the equilibrium theory is sufficient to describe the magnitude and distribution of the main tide-generating forces across the surface of the Earth.

Newton's universal law of gravitation governs both the orbits of celestial bodies and the tide-generating forces which occur on them. The force of gravitational attraction between any two masses, m_1 and m_2 , is given by:

$$F = \frac{Gm_1m_2}{d^2}$$

where d is the distance between the two masses, and G is the universal gravitational constant which depends upon the units employed. This law assumes that m_1 and m_2 are point masses. Newton was able to show that homogeneous spheres could be treated as point masses when determining their orbits.

However, when computing differential gravitational forces, the actual dimensions of the masses must be taken into account.

Using the law of gravitation, it is found that the orbits of two point masses are conic sections about the **barycenter** of the two masses. If either one or both of the masses are homogeneous spheres instead of point masses, the orbits are the same as the orbits which would result if all of the mass of the sphere were concentrated at a point at the center of the sphere. In the case of the Earth-Moon system, both the Earth and the Moon describe elliptical orbits about their barycenter if both bodies are assumed to be homogeneous spheres and the gravitational forces of the Sun and other planets are neglected. The Earth-Moon barycenter is located 74/100 of the distance from the center of the Earth to its surface, along the line connecting the Earth's and Moon's centers. See Figure 3502a.

Thus the center of mass of the Earth describes a very small ellipse about the Earth-Moon barycenter, while the center of mass of the Moon describes a much larger ellipse about the same barycenter. If the gravitational forces of the other bodies of the solar system are neglected, Newton's law of gravitation also predicts that the Earth-Moon barycenter will describe an orbit which is approximately elliptical about the barycenter of the Sun-Earth-Moon system. This barycentric point lies inside the Sun. See Figure 3502b.

3503. The Earth-Moon-Sun System

The fundamental tide-generating force on the Earth has

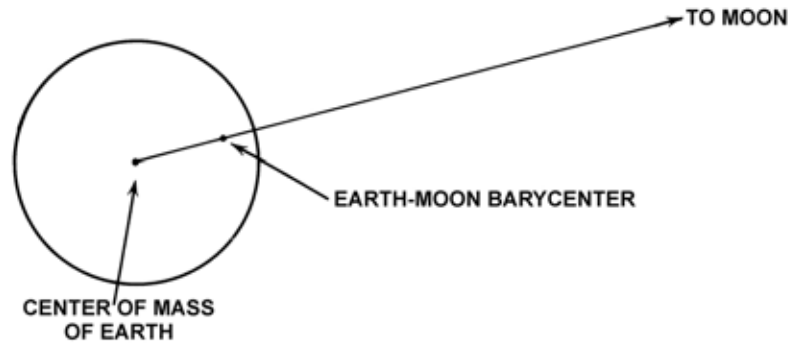

Figure 3502a. Earth-Moon barycenter.

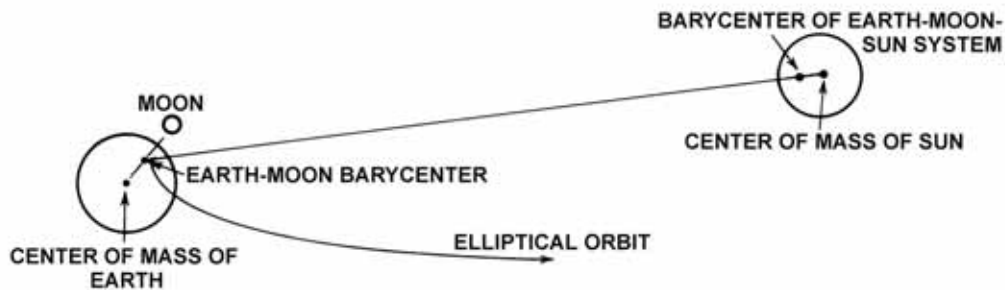

Figure 3502b. Orbit of Earth-Moon barycenter (not to scale).

two interactive but distinct components. The tide-generating forces are differential forces between the gravitational attraction of the bodies (Earth-Sun and Earth-Moon) and the centrifugal forces on the Earth produced by the Earth's orbit around the Sun and the Moon's orbit around the Earth. Newton's Law of Gravitation and his Second Law of Motion can be combined to develop formulations for the differential force at any point on the Earth, as the direction and magnitude are dependent on where you are on the Earth's surface. As a result of these differential forces, the tide generating forces F_{dm} (Moon) and F_{ds} (Sun) are inversely proportional to the cube of the distance between the bodies, where:

$$F_{dm} = \frac{GM_m R_e}{d_m^3}; \quad F_{ds} = \frac{GM_s R_e}{d_s^3}$$

where M_m is the mass of the Moon and M_s is the mass of the Sun, R_e is the radius of the Earth and d is the distance to the Moon or Sun. This explains why the tide-generating force of the Sun is only 46/100 of the tide-generating force of the Moon. Even though the Sun is much more massive,

it is also much farther away.

Using Newton's second law of motion, we can calculate the differential forces generated by the Moon and the Sun affecting any point on the Earth. The easiest calculation is for the point directly below the Moon, known as the **sub-lunar point**, and the point on the Earth exactly opposite, known as the **antipode**. Similar calculations are done for the Sun.

If we assume that the entire surface of the Earth is covered with a uniform layer of water, the differential forces may be resolved into vectors perpendicular and parallel to the surface of the Earth to determine their effect. See Figure 3503a.

The perpendicular components change the mass on which they are acting, but do not contribute to the tidal effect. The horizontal components, parallel to the Earth's surface, have the effect of moving the water in a horizontal direction toward the sublunar and antipodal points until an equilibrium position is found. The *horizontal* components of the differential forces are the principal tide-generating forces. These are also called **tractive** forces. Tractive forces are zero at the sublunar and antipodal points and along the great circle halfway between these two points. Tractive forces are maximum along the small circles located 45°

from the sublunar point and the antipode. Figure 3503b

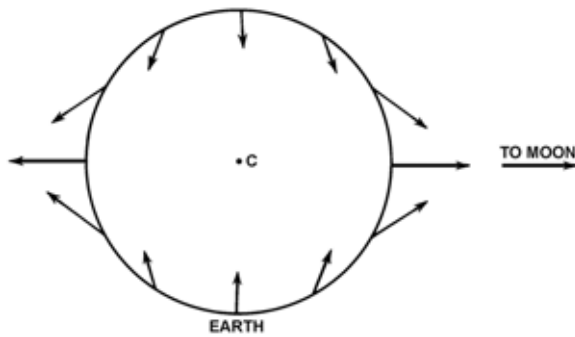

Figure 3503a. Differential forces along a great circle connecting the sublunar point and antipode.

shows the tractive forces across the surface of the Earth.

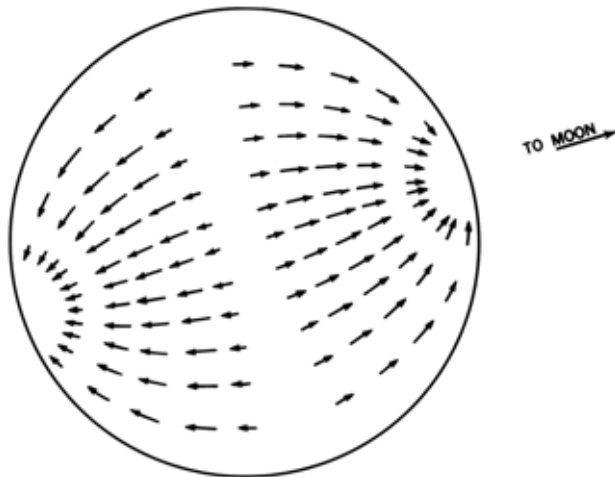

Figure 3503b. Tractive forces across the surface of the Earth.

Equilibrium will be reached when a bulge of water has formed at the sublunar and antipodal points such that the tractive forces due to the Moon's differential gravitational forces on the mass of water covering the surface of the Earth are just balanced by the Earth's gravitational attraction (Figure 3503c).

Now consider the effect of the rotation of the Earth. If the declination of the Moon is 0° , the bulges will lie on the equator. As the Earth rotates, an observer at the equator will

note that the Moon transits approximately every 24 hours and 50 minutes. Since there are two bulges of water on the equator, one at the sublunar point and the other at the antipode, the observer will also see two high tides during this interval with one high tide occurring when the Moon is overhead and another high tide 12 hours 25 minutes later when the observer is at the antipode. He will also experience a low tide between each high tide. The theoretical range of these equilibrium tides at the equator will be less than 1 meter.

In theory, the heights of the two high tides should be equal at the equator. At points north or south of the equator, an observer would still experience two high and two low tides, but the heights of the high tides would not be as great as they are at the equator. The effects of the declination of the Moon are shown in Figure 3503d, for three cases, A, B, and C.

- A. When the Moon is on the plane of the equator, the forces are equal in magnitude at the two points on the same parallel of latitude and 180° apart in longitude.
- B. When the Moon has north or south declination, the forces are unequal at such points and tend to cause an inequality in the two high waters and the two low waters each day.
- C. Observers at points X, Y, and Z experience one high tide when the Moon is on their meridian, then another high tide 12 hours 25 minutes later when at X', Y', and Z'. The second high tide is the same at X' as at X. High tides at Y' and Z' are lower than high tides at Y and Z.

The preceding discussion pertaining to the effects of the Moon is equally valid when discussing the effects of the Sun, taking into account that the magnitude of the solar effect is smaller. Hence, the tides will also vary according to the Sun's declination and its varying distance from the Earth. A second envelope of water representing the equilibrium tides due to the Sun would resemble the envelope shown in Figure 3503c except that the heights of the high tides would be smaller, and the low tides correspondingly not as low. The theoretical tide at any place represents the combination of the effects of both the Moon and Sun.

FEATURES OF TIDES

3504. General Features

At most places the tidal change occurs twice daily. The tide rises until it reaches a maximum height, called **high tide** or **high water**, and then falls to a minimum level called **low tide** or **low water**.

The rate of rise and fall is not uniform. From low water,

the tide begins to rise slowly at first, but at an increasing rate until it is about halfway to high water. The rate of rise then decreases until high water is reached, and then the rise ceases.

The falling tide behaves in a similar manner. The period at high or low water during which there is no apparent change of level is called **stand**. The difference in height be-

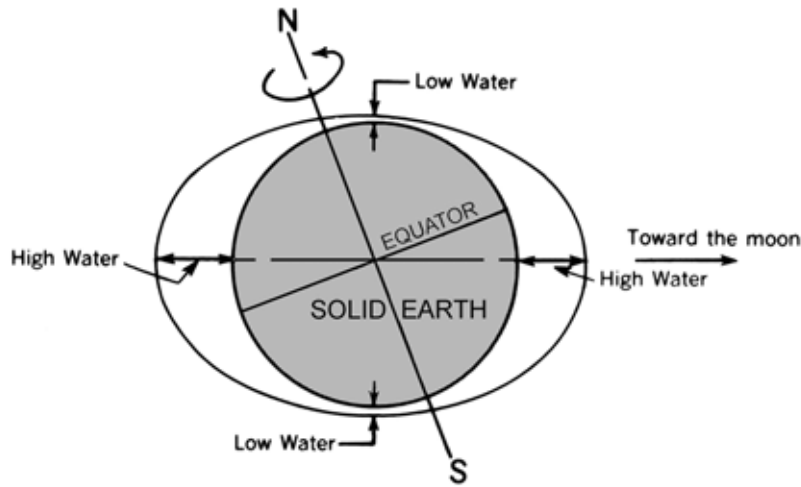

Figure 3503c. Theoretical equilibrium configuration due to Moon's differential gravitational forces. One bulge of the water envelope is located at the sublunar point, the other bulge at the antipode.

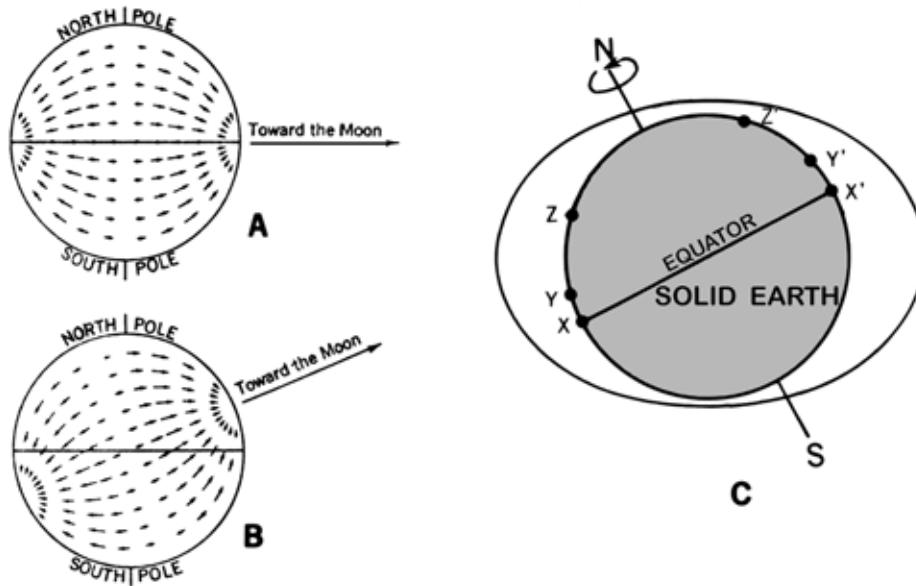

Figure 3503d. Effects of the declination of the Moon.

tween consecutive high and low waters is the **range**.

Figure 3504 is a graphical representation of the rise and fall of the tide at New York during a 24-hour period. The curve has the general form of a variable sine curve.

3505. Types of Tide

A body of water has a natural period of oscillation, dependent upon its dimensions. None of the oceans is a single oscillating body; rather each one is made up of several separate oscillating basins. As such basins are acted upon by the tide-producing forces, some respond

more readily to daily or diurnal forces, others to semidiurnal forces, and others almost equally to both. Hence, tides are classified as one of three types, semidiurnal, diurnal, or mixed, according to the characteristics of the tidal pattern.

In the **semidiurnal tide**, there are two high and two low waters each tidal day, with relatively small differences in the respective highs and lows. Tides on the Atlantic coast of the United States are of the semidiurnal type, which is illustrated in Figure 3505a by the tide curve for Boston Harbor.

In the **diurnal tide**, only a single high and single low

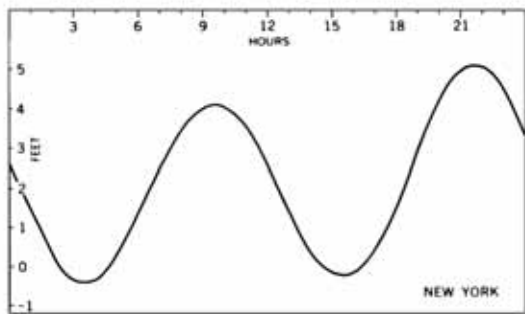

Figure 3504. The rise and fall of the tide at New York, shown graphically.

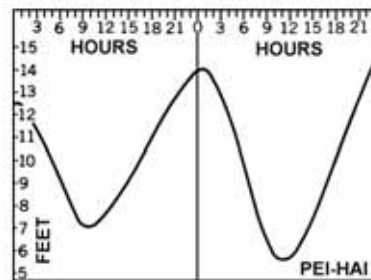

Figure 3505b. Diurnal tide.

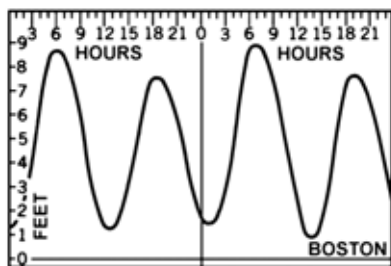

Figure 3505a Semidiurnal tide

water occur each tidal day. Tides of the diurnal type occur along the northern shore of the Gulf of Mexico, in the Java Sea, the Gulf of Tonkin, and in a few other localities. The tide curve for Pei-Hai, China, illustrated in Figure 3505b, is an example of the diurnal type.

In the **mixed tide**, the diurnal and semidiurnal oscillations are both important factors and the tide is characterized by a large inequality in the high water heights, low water heights, or in both. There are usually two high and two low waters each day, but occasionally the tide may become diurnal. Such tides are prevalent along the Pacific coast of the United States and in many other parts of the world. Examples of mixed types of tide are shown in Figure 3505c. At

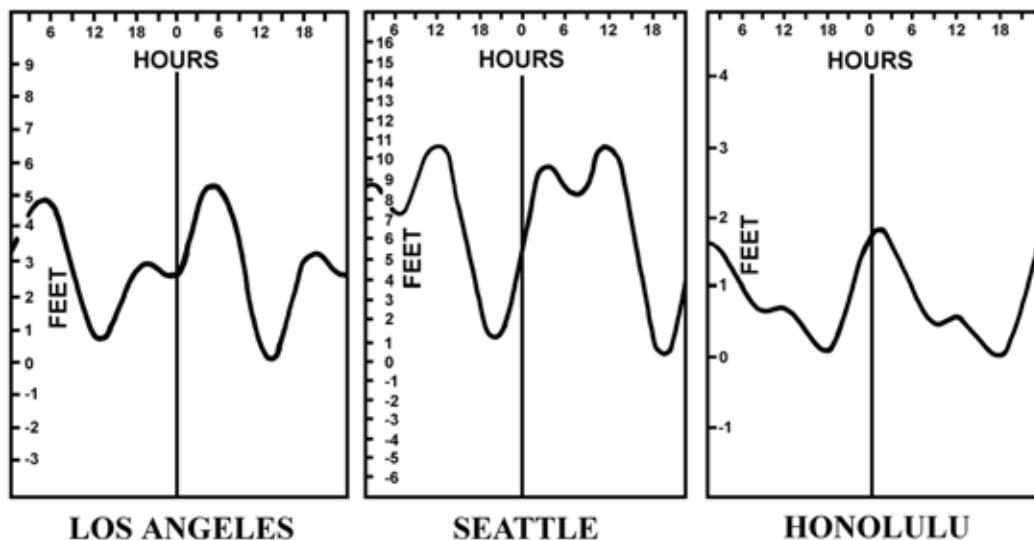

Figure 3505c. Mixed tide.

Los Angeles it is typical that the inequalities in the high and low waters are about the same. At Seattle the greater inequalities are typically in the low waters, while at Honolulu it is the high waters that have the greater inequalities.

3506. Solar Tide

The natural period of oscillation of a body of water may accentuate either the solar or the lunar tidal oscillations. Though as a general rule the tides follow the Moon,

the relative importance of the solar effect varies in different areas. There are a few places, primarily in the South Pacific and the Indonesian areas, where the solar oscillation is the more important, and at those places the high and low waters occur at about the same time each day. At Port Adelaide, Australia the solar and lunar semidiurnal oscillations are equal and nullify one another at neaps.

3507. Special Tidal Effects

As a wave enters shallow water, its speed is decreased. Since the trough is shallower than the crest, it is retarded more, resulting in a steepening of the wave front. In a few estuaries, the advance of the low water trough is so much retarded that the crest of the rising tide overtakes the low, and advances upstream as a breaking wave called a **bore**. Bores that are large and dangerous at times of large tidal ranges may be mere ripples at those times of the month when the range is small. Examples occur in the Petitcodiac River in the Bay of Fundy, and at Haining, China, in the Tsientang Kaing. The tide tables indicate where bores occur.

Other special features are the **double low water** (as at Hoek Van Holland) and the **double high water** (as at Southampton, England). At such places there is often a slight fall or rise in the middle of the high or low water period. The practical effect is to create a longer period of stand at high or low tide. The tide tables list these and other peculiarities where they occur.

3508. Variations in Range

Though the tide at a particular place can be classified as to type, it exhibits many variations during the month (Figure 3508a). The range of the tide varies according to the intensity of the tide-producing forces, though there may be a lag of a day or two between a particular astronomic cause and the tidal effect.

The combined lunar-solar effect is obtained by adding the Moon's tractive forces vectorially to the Sun's tractive forces. The resultant tidal bulge will be predominantly lunar with modifying solar effects upon both the height of the tide and the direction of the tidal bulge. Special cases of interest occur during the times of new and full Moon (Figure 3508b). With the Earth, Moon, and Sun lying approximately on the same line, the tractive forces of the Sun are acting in the same direction as the Moon's tractive forces (modified by declination effects). The resultant tides are called **spring tides**, whose ranges are greater than average.

Between the spring tides, the Moon is at first and third quarters. At those times, the tractive forces of the Sun are acting at approximately right angles to the Moon's tractive forces. The results are tides called **neap tides**, whose ranges are less than average.

With the Moon in positions between quadrature and

new or full, the effect of the Sun is to cause the tidal bulge to either lag or precede the Moon (Figure 3508c). These effects are called **priming** and **lagging** the tides.

Thus, when the Moon is at the point in its orbit nearest the Earth (at perigee), the lunar semidiurnal range is increased and **perigean tides** occur. When the Moon is farthest from the Earth (at apogee), the smaller **apogean tides** occur. When the Moon and Sun are in line and pulling together, as at new and full Moon, **spring tides** occur (the term spring has nothing to do with the season of year); when the Moon and Sun oppose each other, as at the quadratures, the smaller **neap tides** occur. When certain of these phenomena coincide, **perigean spring tides** and **apogean neap tides** occur.

These are variations in the semidiurnal portion of the tide. Variations in the diurnal portion occur as the Moon and Sun change declination. When the Moon is at its maximum semi-monthly declination (either north or south), **tropic tides** occur in which the diurnal effect is at a maximum. When it crosses the equator, the diurnal effect is a minimum and **equatorial tides** occur.

When the range of tide is increased, as at spring tides, there is more water available only at high tide; at low tide there is less, for the high waters rise higher and the low waters fall lower at these times. There is more water at neap low water than at spring low water. With tropic tides, there is usually more depth at one low water during the day than at the other. While it is desirable to know the meanings of these terms, the best way of determining the height of the tide at any place and time is to examine the tide predictions for the place as given in the tide tables, which take all these effects into account.

3509. Tidal Cycles

Tidal oscillations go through a number of cycles. The shortest cycle, completed in about 12 hours and 25 minutes for a semidiurnal tide, extends from any phase of the tide to the next recurrence of the same phase. During a lunar day (averaging 24 hours and 50 minutes) there are two highs and two lows (two of the shorter cycles) for a semidiurnal tide. The Moon revolves around the Earth with respect to the Sun in a **synodical month** of about 29 1/2 days, commonly called the **lunar month**. The effect of the phase variation is completed in one-half of a synodical month or about 2 weeks as the Moon varies from new to full or full to new.

The effect of the Moon's declination is also repeated in one-half of a **tropical month** of 27 1/3 days, or about every 2 weeks. The cycle involving the Moon's distance requires an **anomalous month** of about 27 1/2 days. The Sun's declination and distance cycles are respectively a half year and a year in length.

An important lunar cycle, called the **nodal period** or Metonic cycle (after Greek philosopher Meton, fifth century B.C., who discovered the phenomenon) is 18.6

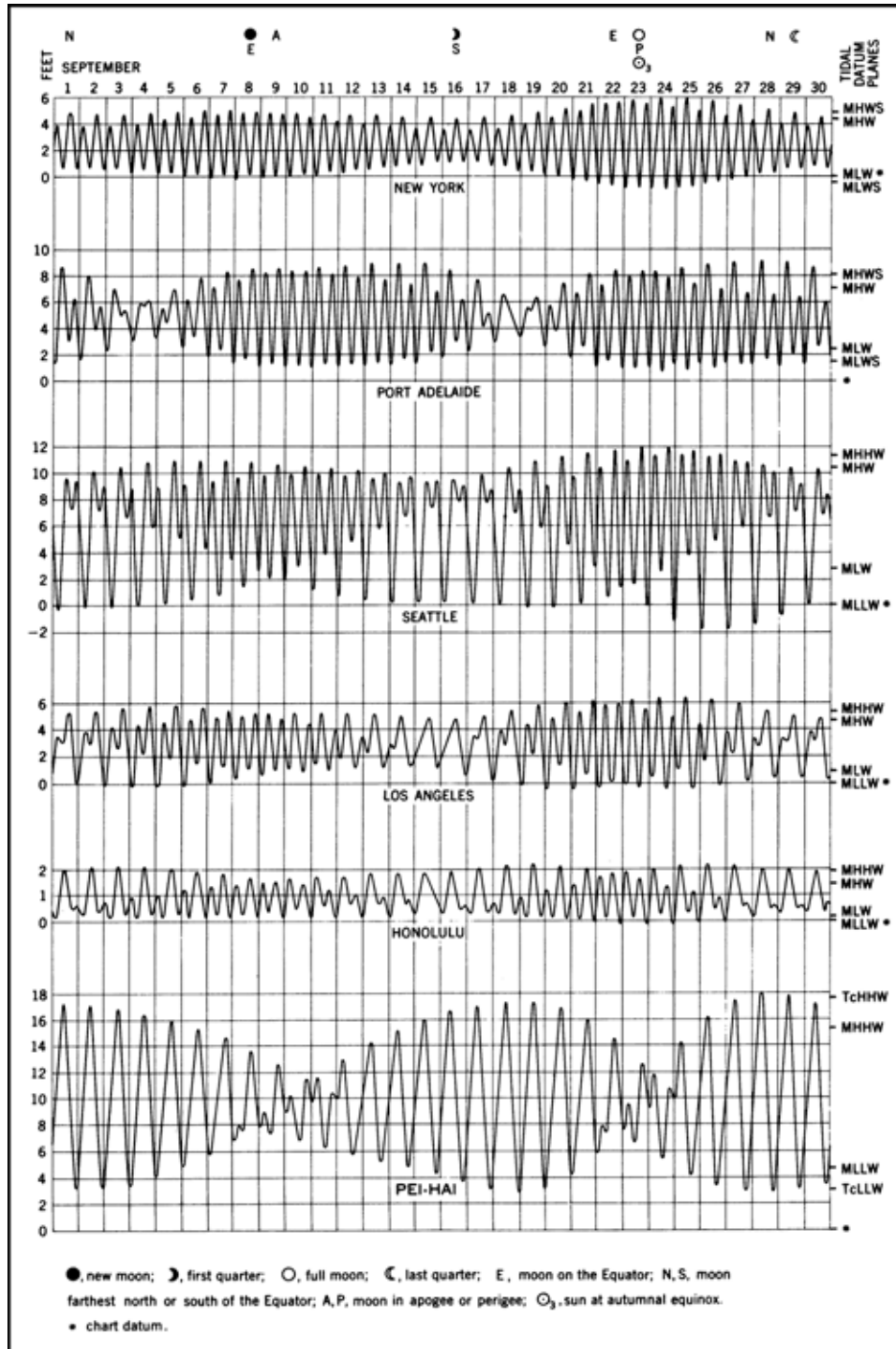

Figure 3508a. Monthly tidal variations at various places.

years (usually expressed in round figures as 19 years). For a tidal value, particularly a range, to be considered a true mean, it must be either based upon observations extended over this period of time, or adjusted to take account of variations known to occur during the nodal period.

The nodal period is the result of axis of the Moon's rotation being tilted 5 degrees with respect to the axis of the

Earth's rotation. Since the Earth's axis is tilted 23.5 degrees with respect to the plane of its revolution around the sun, the combined effect is that the Moon's declination varies from 28.5 degrees to 18.5 degrees in a cycle lasting 18.6 years. For practical purposes, the nodal period can be considered as the time between the Sun and Moon appearing in precisely the same relative positions in the sky.

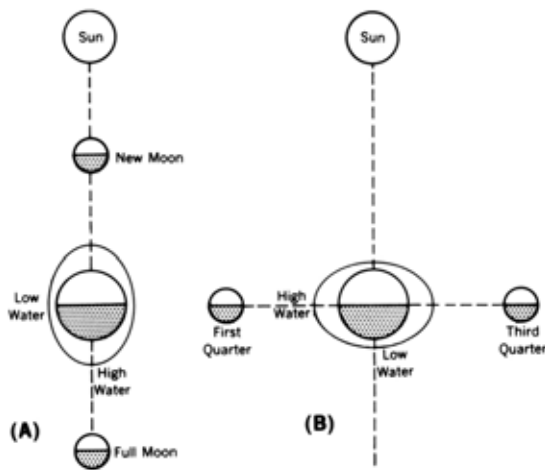
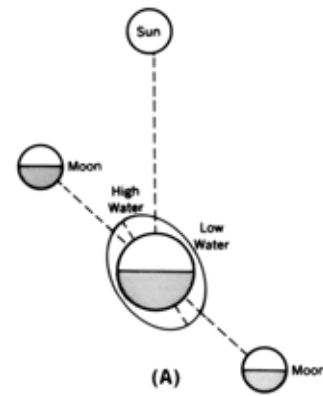

Figure 3508b. (A) Spring tides occur at times of new and full Moon. Range of tide is greater than average since solar and lunar tractive forces act in same direction. (B) Neap tides occur at times of first and third quarters. Range of tide is less than average since solar and lunar tractive forces act at right angles.

3510. Time of Tide

Since the lunar tide-producing force has the greatest effect in producing tides at most places, the tides “follow the Moon.” Because the Earth rotates, high water lags behind both upper and lower meridian passage of the Moon. The **tidal day**, which is also the lunar day, is the time between consecutive transits of the Moon, or 24 hours and 50 minutes on the average. Where the tide is largely semidiurnal in type, the **lunitidal interval** (the interval between the Moon’s meridian transit and a particular phase of tide) is fairly constant throughout the month, varying somewhat with the tidal cycles. There are many places, however, where solar or diurnal oscillations are effective in upsetting this relationship. The interval generally given is the average elapsed time from the meridian transit (upper or lower) of the Moon until the next high tide. This may be called **mean high water lunitidal interval** or **corrected (or mean) establishment**. The **common establishment** is the average interval on days of full or new Moon, and approximates the mean high water lunitidal interval.

In the ocean, the tide may be in the nature of a progressive wave with the crest moving forward, a stationary or standing wave which oscillates in a seesaw fashion, or a combination of the two. Consequently, caution should be used in inferring the time of tide at a place from tidal data for nearby places. In a river or estuary, the tide enters from the sea and is usually sent upstream as a progressive wave so that the tide occurs progressively later at various places upstream.



Priming occurs when moon is between new and first quarter and between full and third quarter. High tide occurs before transit moon.

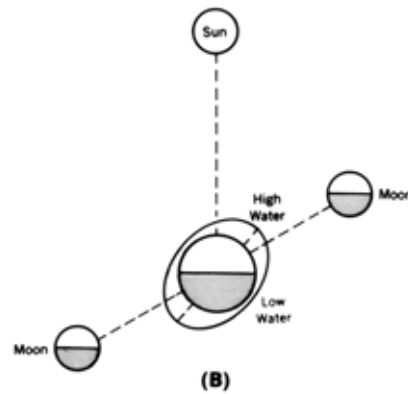

Lagging occurs when moon is between first quarter and full and between third quarter and new. High tide occurs after transit of moon.

Figure 3508c. Priming and lagging the tides.

3511. Tides and Water Levels Online Tutorial

An excellent **online tutorial** created by NOAA’s National Ocean Service is available via the link provided in Figure 3511. Topics in this tutorial include: *What are Tides,*



Figure 3511. NOAA’s Tides and Water Levels tutorial. https://oceanservice.noaa.gov/education/tutorial_tides/

What Causes Tides; Gravity, Inertia and Bulges; Changing Angles and Tides, Frequency of Tides, Tidal Variations, and Types and Causes of Tidal Cycles.

TIDAL DATUMS

3512. Low Water Datums

A tidal datum is a given average tide level from which heights of tides and overhead clearances are measured. It is a vertical datum, but is not the same as vertical geodetic datum,

which is a mathematical quantity developed as part of a geodetic system used for horizontal positioning. There are a number of tidal levels of reference that are important to the mariner. See Figure 3512.

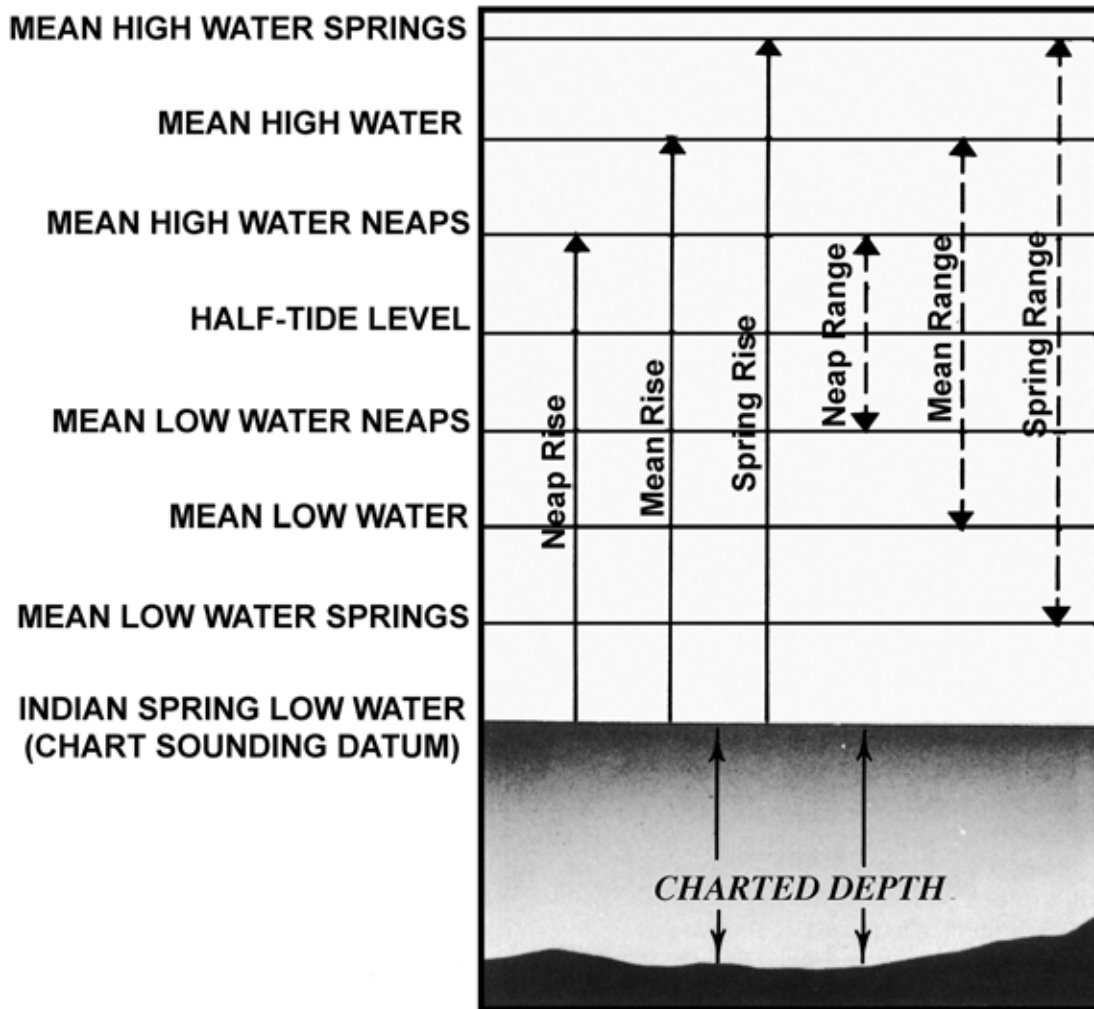

Figure 3512. Variations in the ranges and heights of tide where the chart sounding datum is Indian Spring Low Water.

The most important level of reference is the **sounding datum** shown on charts. The sounding datum is sometimes referred to as the reference plane to distinguish it from vertical geodetic datum. Since the tide rises and falls continually while soundings are being taken during a hydrographic survey, the tide is recorded during the survey so that soundings taken at all stages of the tide can be reduced to a common sounding datum. Soundings on charts show depths below a selected low water datum (occasionally mean sea level), and tide predictions in tide tables show heights above and below the same level. The depth of water available at any time is obtained by adding algebraically the height of the tide at the time in question to the charted

depth.

By international agreement, the level used as chart datum should be low enough so that low waters do not fall very far below it. At most places, the level used is one determined from a mean of a number of low waters (usually over a 19 year period); therefore, some low waters can be expected to fall below it. The following are some of the datums in general use.

Mean low water (MLW) is the average height of all low waters at a given place. About half of the low waters fall below it, and half above.

Mean low water springs (MLWS), usually shortened to low water springs, is the average level of the low waters

that occur at the times of spring tides.

Mean lower low water (MLLW) is the average height of the lower low waters of each tidal day.

Tropic lower low water (TcLLW) is the average height of the lower low waters (or of the single daily low waters if the tide becomes diurnal) that occur when the Moon is near maximum declination and the diurnal effect is most pronounced. This datum is not in common use as a tidal reference.

Indian spring low water (ISLW), sometimes called **Indian tide plane** or **harmonic tide plane**, is a low water datum that includes the spring effect of the semi-diurnal portion of the tide and the tropic effect of the diurnal portion. It is about the level of lower low water of mixed tides at the time that the Moon's maximum declination coincides with the time of new or full Moon.

Mean lower low water springs (MLLWS) is the average level of the lower of the two low waters on the days of spring tides.

Some lower datums used on charts are determined from tide observations and some are determined arbitrarily and later referred to the tide. Most of them fall close to one or the other of the following two datums.

Lowest normal low water is a datum that approximates the average height of monthly lowest low waters, discarding any tides disturbed by storms.

Lowest low water is an extremely low datum. It conforms generally to the lowest tide observed, or even somewhat lower. Once a tidal datum is established, it is sometimes retained for an indefinite period, even though it might differ slightly from a better determination from later observations. When this occurs, the established datum may be called **low water datum**, **lower low water datum**, etc. These datums are used in a limited area and primarily for river and harbor engineering purposes. Examples are Boston Harbor Low Water Datum and Columbia River Lower Low Water Datum.

Some sounding datums are based on the predicted tide rather than an average of observations. A British sounding datum that may be adopted internationally is the **Lowest Astronomical Tide (LAT)**. LAT is the elevation of the lowest water level predicted in a 19-year period. Canadian coastal charts use a datum of **Lower Low Water, Large Tide (LLWLT)** which is the average of the lowest low waters, one from each of the 19 years of predictions.

Figure 3512 illustrates variations in the ranges and heights of tides in a locality such as the Indian Ocean, where predicted and observed water levels are referenced to a chart sounding datum that will always cause them to be additive relative to the charted depth.

In areas where there is little or no tide, various other datums are used. For the Black Sea for instance, **Mean Sea Level (MSL)**, sometimes referred to as **Mean Water Level** or

MWL) is used, and is the average of the hourly heights observed over a period of time and adjusted to a 19-year period. In the United States, a **Low Water Datum (LWD)** is used in those coastal areas that have transitioned from tidal to non-tidal (e.g. Laguna Madre, Texas and Pamlico Sound, North Carolina) and is simply 0.5 foot below a computed MLW. For the Great Lakes, the United States and Canada use a separate LWD for each lake, which is designed to ensure that the actual water level is above the datum most of the time during the navigation season. Lake levels vary by several feet over a period of years.

Inconsistencies of terminology are found among charts of different countries and between charts issued at different times.

Large-scale charts usually specify the datum of soundings and may contain a tide note giving mean heights of the tide at one or more places on the chart. These heights are intended merely as a rough guide to the change in depth to be expected under the specified conditions. They should not be used for the prediction of heights on any particular day, which should be obtained from tide tables.

3513. High Water Datums

Heights of terrestrial features are usually referred on nautical charts to a high water datum. This gives the mariner a margin of error when passing under bridges, overhead cables, and other obstructions. The one used on charts of the United States, its territories and possessions, and widely used elsewhere, is **mean high water (MHW)**, which is the average height of all high waters over a 19 year period. Any other high water datum in use on charts is likely to be higher than this. Other high water datums are **mean high water springs (MHWS)**, which is the average level of the high waters that occur at the time of spring tides; **mean higher high water (MHHW)**, which is the average height of the higher high waters of each tidal day; and **tropic higher high water (TcHHW)**, which is the average height of the higher high waters (or the single daily high waters if the tide becomes diurnal) that occur when the Moon is near maximum declination and the diurnal effect is most pronounced. A reference merely to "high water" leaves some doubt as to the specific level referred to, for the height of high water varies from day to day. Where the range is large, the variation during a 2 week period may be considerable.

Because there are periodic and apparent secular trends in sea level, a specific 19 year cycle (the **National Tidal Datum Epoch**) is issued for all United States datums. The National Tidal Datum Epoch officially adopted by the National Ocean Service is presently 1983 through 2001. The Epoch is reviewed for revision every 20 -25 years.

TIDAL CURRENTS

3514. Tidal and Nontidal Currents

Horizontal movement of water is called **current**. It may be either “tidal” and “nontidal.” **Tidal current** is the periodic horizontal flow of water accompanying the rise and fall of the tide. **Nontidal current** includes all currents not due to the tidal movement. Nontidal currents include the permanent currents in the general circulatory system of the oceans as well as temporary currents arising from meteorological conditions. The current experienced at any time is usually a combination of tidal and nontidal currents.

3515. General Features

Offshore, where the direction of flow is not restricted by any barriers, the tidal current is rotary; that is, it flows continuously, with the direction changing through all points of the compass during the tidal period. This rotation is caused by the Earth’s rotation, and unless modified by local conditions, is clockwise in the Northern Hemisphere and counterclockwise in the Southern Hemisphere. The speed usually varies throughout the tidal cycle, passing through two maximums in approximately opposite directions, and two minimums about halfway between the maximums in time and direction. Rotary currents can be depicted as in Figure 3515a, by a series of arrows representing the direction and speed of the current at each hour. This is sometimes called a **current rose**. Because of the elliptical pattern formed by the ends of the arrows, it is also referred to as a **current ellipse**.

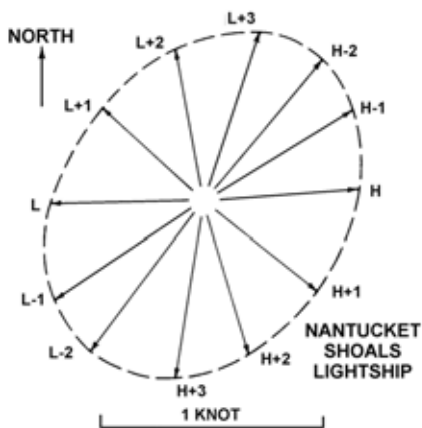

Figure 3515a. Rotary tidal current. Times are hours before and after high and low tide at Nantucket Shoals. The bearing and length of each arrow represents the hourly direction and speed of the current.

In rivers or straits, or where the direction of flow is more or less restricted to certain channels, the tidal current is reversing; that is, it flows alternately in approximately

opposite directions with an instant or short period of little or no current, called **slack water**, at each reversal of the current. During the flow in each direction, the speed varies from zero at the time of slack water to a maximum, called strength of flood or ebb, about midway between the slacks. Reversing currents can be indicated graphically, as in Figure 3515b, by arrows that represent the speed of the current at each hour. The flood is usually depicted above the slack waterline and the ebb below it. The tidal current curve formed by the ends of the arrows has the same characteristic sine form as the tide curve. In illustrations and for certain other purposes it is convenient to omit the arrows and show only the curve.

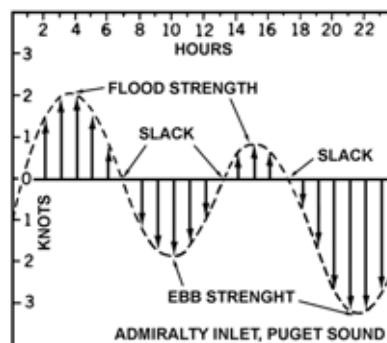

Figure 3515b. Reversing tidal current.

A slight departure from the sine form is exhibited by the reversing current in a strait that connects two different tidal basins, such as the East River, New York. The tides at the two ends of a strait are seldom in phase or equal in range, and the current, called **hydraulic current**, is generated largely by the continuously changing difference in height of water at the two ends. The speed of a hydraulic current varies nearly as the square root of the difference in height. The speed reaches a maximum more quickly and remains at strength for a longer period than shown in Figure 3515b, and the period of weak current near the time of slack is considerably shortened.

The current direction, or **set**, is the direction toward which the current flows. The speed is sometimes called the **drift**. The term “velocity” is often used as the equivalent of “speed” when referring to current, although strictly speaking “velocity” implies direction as well as speed. The term “strength” is also used to refer to speed, but more often to greatest speed between consecutive slack waters. The movement toward shore or upstream is the **flood**, the movement away from shore or downstream is the **ebb**. In a purely semidiurnal current unaffected by nontidal flow, the flood and ebb each last about 6 hours and 13 minutes. But if there is either diurnal inequality or nontidal flow, the durations of flood and ebb may be quite unequal.

3516. Types of Tidal Current

Tidal currents, like tides, may be of the **semidiurnal**, **diurnal**, or **mixed** type, corresponding to a considerable degree to the type of tide at the place, but often with a stronger semidiurnal tendency.

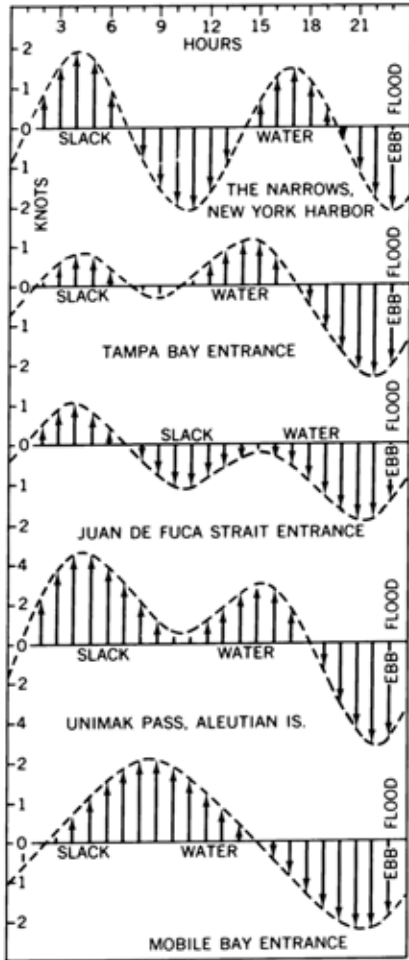

Figure 3516a. Several types of reversing current. The pattern changes gradually from day to day, particularly for mixed types, passing through cycles.

The tidal currents in tidal estuaries along the Atlantic coast of the United States are examples of the semidiurnal type of reversing current. Along the Gulf of Mexico coast, such as at Mobile Bay entrance, they are almost purely diurnal. At most places, however, the type is mixed to a greater or lesser degree. At Tampa and Galveston entrances there is only one flood and one ebb each day when the Moon is near its maximum declination, and two floods and two ebbs each day when the Moon is near the equator. Along the Pacific coast of the United States there are generally two floods and two ebbs every day, but one of the floods or ebbs has a greater speed and longer duration than the other, the inequality varying with the declination of the Moon.

The inequalities in the current often differ considerably from place to place even within limited areas, such as adja-

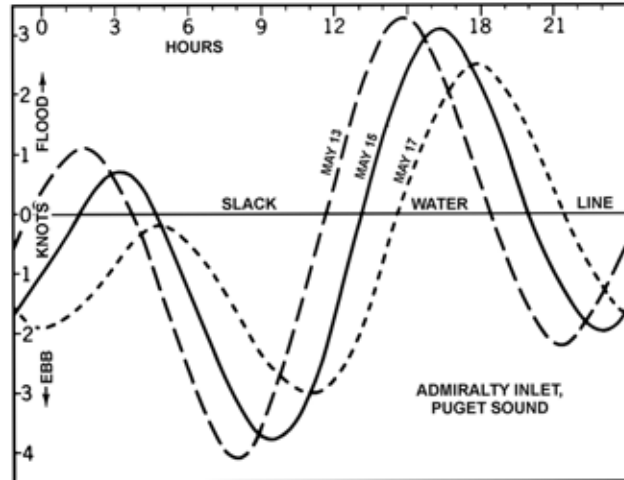

Figure 3516b. Changes in a current of the mixed type. Note that each day as the inequality increases, the morning slacks draw together in time until on the 17th the morning flood disappears. On that day the current ebbs throughout the morning.

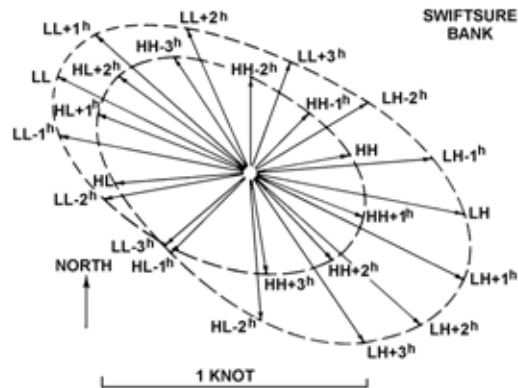

Figure 3516c. Rotary tidal current with diurnal inequality. Times are in hours referred to tides (higher high, lower low, lower high, and higher low) at Swiftsure Bank.

cent passages in Puget Sound and various passages between the Aleutian Islands. Figure 3516a shows several types of reversing current. Figure 3516b shows how the flood disappears as the diurnal inequality increases at one station.

Offshore rotary currents that are purely semidiurnal repeat the elliptical pattern each tidal cycle of 12 hours and 25 minutes. If there is considerable diurnal inequality, the plotted hourly current arrows describe a set of two ellipses of different sizes during a period of 24 hours and 50 minutes, as shown in Figure 3516c, and the greater the diurnal inequality, the greater the difference between the sizes of the two ellipses. In a completely diurnal rotary current, the smaller ellipse disappears and only one ellipse is produced in 24 hours and 50 minutes.

3517. Tidal Current Periods and Cycles

Tidal currents have periods and cycles similar to those of the tides, and are subject to similar variations, but flood and ebb of the current do not necessarily occur at the same times as the rise and fall of the tide.

The speed at flood or ebb strength increases and decreases during the 2 week period, month, and year along with the variations in the range of tide. Thus, the stronger spring and perigean currents occur near the times of new and full Moon and near the times of the Moon's perigee, or at times of spring and perigean tides; the weaker neap and apogean currents occur at the times of neap and apogean tides. Tropic currents with increased diurnal speeds or with larger diurnal inequalities in speed occur at times of tropic tides and equatorial currents with a minimum diurnal effect occur at times of equatorial tides.

As with the tide, a mean value represents an average obtained from a 19 year series. Since a series of current observations is usually limited to a few days, and seldom covers more than a month or two, it is necessary to adjust the observed values, usually by comparison with tides at a nearby place, to obtain such a mean.

3518. Effect of Nontidal Flow

The current existing at any time is seldom purely tidal, but usually includes also a nontidal current that is due to drainage, oceanic circulation, wind, or other causes. The method in which tidal and nontidal currents combine is best explained graphically, as in Figure 3518a and Figure 3518b. The pattern of the tidal current remains unchanged, but the curve is shifted from the point or line from which the currents are measured, in the direction of the nontidal current, and by an amount equal to it. It is sometimes more convenient graphically merely to move the line or point of origin in the opposite direction. Thus, the speed of the current flowing in the direction of the nontidal current is increased by an amount equal to the magnitude of the nontidal current, and the speed of the current flowing in the opposite direction is decreased by an equal amount.

In Figure 3518a, a nontidal current is represented both in direction and speed by the vector AO. Since this is greater than the speed of the tidal current in the opposite direction, the point A is outside the ellipse. The direction and speed of the combined tidal and nontidal currents at any time is represented by a vector from A to that point on the curve representing the given time, and can be scaled from the graph. The strongest and weakest currents may no longer be in the directions of the maximum and minimum of the tidal current. If the nontidal current is northwest at 0.3 knot, it may be represented by BO, and all hourly directions and speeds will then be measured from B. If it is 1.0 knot, it will be represented by AO and the actual resultant hourly directions and speeds will be measured from A, as shown by the arrows.

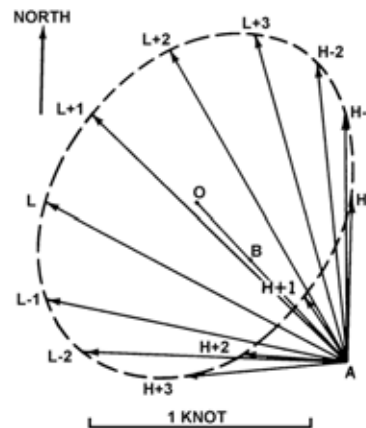

Figure 3518a. Effect of nontidal current on the rotary tidal current of Figure 3515a.

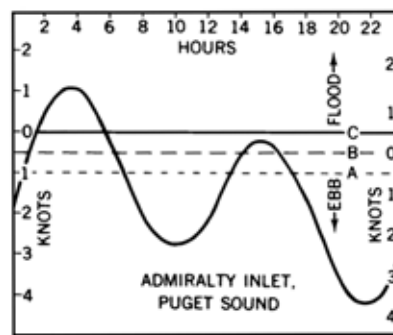

Figure 3518b. Effect of nontidal current on the reversing tidal current of Figure 3515b.

advance the time of one slack, and to retard the following one. If the speed of the nontidal current exceeds that of the reversing tidal current, the resultant current flows continuously in one direction without coming to a slack. In this case, the speed varies from a maximum to a minimum and back to a maximum in each tidal cycle. In Figure 3518b, the horizontal line A represents slack water if only tidal currents are present. Line B represents the effect of a 0.5 knot nontidal ebb, and line C the effect of a 1.0 knot nontidal ebb. With the condition shown at C there is only one flood each tidal day. If the nontidal ebb were to increase to approximately 2 knots, there would be no flood, two maximum ebbs and two minimum ebbs occurring during a tidal day.

3519. Time of Tidal Current and Time of Tide

At many places where current and tide are both semidiurnal, there is a definite relationship between times of current and times of high and low water in the locality. Current atlases and notes on nautical charts often make use

of this relationship by presenting for particular locations, the direction and speed of the current at each succeeding hour after high and low water, at a place for which tide predictions are available.

Where there is considerable diurnal inequality in tide or current, or where the type of current differs from the type of tide, the relationship is not constant, and it may be hazardous to try to predict the times of current from times of tide. Note the current curve for Unimak Pass in the Aleutians in Figure 3516a. It shows the current as predicted in the tidal current tables. Predictions of high and low waters in the tide tables might have led one to expect the current to change from flood to ebb in the late morning, whereas actually the current continued to run flood with some strength at that time.

Since the relationship between times of tidal current and tide is not the same everywhere, and may be variable at the same place, one should exercise extreme caution in using general rules. The belief that slacks occur at local high and low tides and that the maximum flood and ebb occur when the tide is rising or falling most rapidly may be approximately true at the seaward entrance to, and in the upper reaches of, an inland tidal waterway. But generally this is not true in other parts of inland waterways. When an inland waterway is extensive or its entrance constricted, the slacks in some parts of the waterway often occur midway between the times of high and low tide. Usually in such waterways the relationship changes from place to place as one progresses upstream, slack water getting progressively closer in time to the local tide maximum until at the head of tidewater (the inland limit of water affected by a tide) the slacks occur at about the times of high and low tide.

3520. Relationship Between Speed of Current and Range of Tide

The speed of the tidal current is not necessarily consistent with the range of tide. It may be the reverse. For example, currents are weak in the Gulf of Maine where the tides are large, and strong near Nantucket Island and in Nantucket Sound where the tides are small. However, at any one place the speed of the current at strength of flood and ebb varies during the month in about the same proportion as the range of tide, and this relationship can be used to determine the relative strength of currents on any given day.

3521. Variation Across an Estuary

In inland tidal estuaries the time of tidal current varies

across the channel from shore to shore. On the average, the current turns earlier near shore than in midstream, where the speed is greater. Differences of half an hour to an hour are not uncommon, but the difference varies and the relationship may be nullified by the effect of nontidal flow.

The speed of the current also varies across the channel, usually being greater in midstream or midchannel than near shore, but in a winding river or channel the strongest currents occur near the concave shore, or the outside corner of the curve. Near the opposite (convex) shore the currents are weak or eddying.

3522. Variation with Depth

In tidal rivers the subsurface current acting on the lower portion of a ship's hull may differ considerably from the surface current. An appreciable subsurface current may be present when the surface movement appears to be practically slack, and the subsurface current may even be flowing with appreciable speed in the opposite direction to the surface current.

In a tidal estuary, particularly in the lower reaches where there is considerable difference in density from top to bottom, the flood usually begins earlier near the bottom than at the surface. The difference may be an hour or two, or as little as a few minutes, depending upon the estuary, the location in the estuary, and freshet conditions. Even when the freshwater runoff becomes so great as to prevent the surface current from flooding, it may still flood below the surface. The difference in time of ebb from surface to bottom is normally small but subject to variation with time and location.

The ebb speed at strength usually decreases gradually from top to bottom, but the speed of flood at strength often is stronger at subsurface depths than at the surface.

3523. Tidal Current Observations

Observations of current are made with sophisticated electronic **current meters**. Current meters are suspended from a buoy or anchored to the bottom with no surface marker at all. Very sensitive current meters measure and record deep ocean currents; these are later recovered by triggering a release mechanism with a signal from the surface. Untended current meters either record data internally or send it by radio or satellite to a base station on ship or land. The period of observation varies from a few hours to few years.

TIDE AND CURRENT PREDICTION

3524. Tidal Height Predictions

To measure the height of tides, hydrographers select a

reference level, sometimes referred to as the reference plane, or vertical datum. This vertical tidal datum is not the same as the vertical geodetic datum. Soundings shown on

the largest scale charts are the vertical distances from this datum to the bottom. At any given time the actual depth is this charted depth plus the height of tide. In most places the reference level is some form of low water. But all low waters at a given place are not the same height, and the selected reference level is seldom the lowest tide occurring at the place. When lower tides occur, these are indicated in the tide tables by a negative sign. Thus, at a spot where the charted depth is 15 feet, the actual depth is 15 feet plus the tidal height. When the tide is three feet, the depth is $15 + 3 = 18$ feet. When it is -1 foot, the depth is $15 - 1 = 14$ feet. The actual depth can be less than the charted depth. In an area where there is a considerable range of tide (the difference between high water and low water), the height of tide might be an important consideration when using soundings to determine if the vessel is in safe water.

The heights given in the tide tables are predictions, and when assumed conditions vary considerably, the predictions shown may be considerably in error. Heights lower than predicted can be anticipated when the atmospheric pressure is higher than normal, or when there is a persistent strong offshore wind. The greater the range of tide, the less reliable are the predictions for both height and current.

3525. Tidal Heights

The nature of the tide at any place can best be determined by observation. The predictions in tide tables and the tidal data on nautical charts are based upon detailed observations at specific locations, instead of theoretical predictions.

Tidal elevations are usually observed with a continuously recording gage. A year of observations is the minimum length desirable for determining the harmonic constants used in prediction. For establishing mean sea level and long-term changes in the relative elevations of land and sea, as well as for other special uses, observations have been made over periods of 20, 30, and even 120 years at important locations. Observations for a month or less will establish the type of tide and suffice for comparison with a longer series of observations to determine tidal differences and constants.

Mathematically, the variations in the lunar and solar tide-producing forces, such as those due to changing phase, distance, and declination, are considered as separate constituent forces, and the harmonic analysis of observations reveals the response of each constituent of the tide to its corresponding force. At any one place this response remains constant and is shown for each constituent by **harmonic constants** which are in the form of a phase angle for the time relation and an amplitude for the height. Harmonic constants are used in making technical studies of the tide and in tidal predictions on computers.

3526. Meteorological Effects

The foregoing discussion of tidal behavior assumes normal weather conditions. However, sea level is also affected by wind and atmospheric pressure. In general, onshore winds raise the level and offshore winds lower it, but the amount of change varies at different places. During periods of low atmospheric pressure, the water level tends to be higher than normal. For a stationary low, the increase in elevation can be found by the formula

$$R_0 = 0.01(1010 - P),$$

in which R_0 is the increase in elevation in meters and P is the atmospheric pressure in hectopascals. This is equal approximately to 1 centimeter per hectopascal depression, or about 13.6 inches per inch depression. For a moving low, the increase in elevation is given by the formula

$$R = \frac{R_0}{1 - \frac{C^2}{gh}}$$

in which R is the increase in elevation in feet, R_0 is the increase in meters for a stationary low, C is the rate of motion of the low in feet per second, g is the acceleration due to gravity (32.2 feet per second per second), and h is the depth of water in feet.

Where the range of tide is very small, the meteorological effect may sometimes be greater than the normal tide. Where a body of water is large in area but shallow, high winds can push the water from the windward to the lee shore, creating much greater local differences in water levels than occurs normally, and partially or completely masking the tides. The effect is dependent on the configuration and depth of the body of water relative to the wind direction, strength and duration.

3527 Tidal Current Predictions

Tidal currents are due primarily to tidal action, but other causes are often present. The *Tidal Current Tables* give the best prediction of total current. Following heavy rains or a drought, a river's current prediction may be considerably in error. Set and drift may vary considerably over different parts of a harbor, because differences in bathymetry from place to place affect current. Since this is usually an area where small errors in a vessel's position are crucial, a knowledge of predicted currents, particularly in reduced visibility, is important. Strong currents occur mostly in narrow passages connecting larger bodies of water. Currents of more than 5 knots are sometimes encountered at the Golden Gate in San Francisco, and currents of more than 13 knots sometimes occur at Seymour Narrows, British Columbia.

In straight portions of rivers and channels, the strongest currents usually occur in the middle of the channel. In curved portions the swiftest currents (and deepest water)

usually occur near the outer edge of the curve. Counter-currents and eddies may occur on either side of the main current of a river or narrow passage, especially near obstructions and in bights.

In general, the range of tide and the velocity of tidal current are at a minimum in the open ocean or along straight

coasts. The greatest tidal effects are usually encountered in estuaries, bays, and other coastal indentations. A vessel proceeding along an indented coast may encounter a set toward or away from the shore; a similar set is seldom experienced along a straight coast.

PUBLICATIONS FOR PREDICTING TIDES AND CURRENTS

3528. *Tide Tables*

Usually, tidal information is obtained from tide and tidal current tables, or from specialized computer software or calculators. However, if these are not available, or if they do not include information at a desired place, the mariner may be able to obtain locally the **mean high water lunitidal interval**. The approximate time of high water can be found by adding either interval to the time of transit (either upper or lower) of the Moon. Low water occurs approximately 1/4 tidal day (about 6^h 12^m) before and after the time of high water. The actual interval varies somewhat from day to day, but approximate results can be obtained in this manner. Similar information for tidal currents (**lunicurrent interval**) is seldom available.

The National Ocean Service (NOS) has traditionally published hard copy tide tables and tidal current tables. Tide and tidal current data continue to be updated by NOS, but hardcopy publication has been transferred to private companies working with NOS data.

Tidal data for various parts of the world is published in 4 volumes by the National Ocean Service. These volumes are:

- Central and Western Pacific Ocean and Indian Ocean
- East Coast of North and South America (including Greenland)
- Europe and West Coast of Africa
- West Coast of North and South America (including the Hawaiian Islands)

A small separate volume, the Alaskan Supplement, is also published.

Each volume has 5 common tables:

- **Table 1** contains a complete list of the predicted times and heights of the tide for each day of the year at a number of places designated as **reference stations**.
- **Table 2** gives tidal differences and ratios which can be used to modify the tidal information for the reference stations to make it applicable to a relatively large number of **subordinate stations**.
- **Table 3** provides information for finding the approximate height of the tide at any time between high water and low water.

- **Table 4** is a sunrise-sunset table at five-day intervals for various latitudes from 76°N to 60°S (40°S in one volume).
- **Table 5** provides an adjustment to convert the local mean time of Table 4 to zone or standard time.

For the East Coast and West Coast volumes, each contains a Table 6, a moonrise and moonset table; Table 7 for conversion from feet to centimeters; Table 8, a table of estimated tide prediction accuracies; a glossary of terms; and an index to stations. Table 9, an explanation and table of the lowest and highest astronomical tide and other datums. Each table is preceded by a complete explanation. Sample problems are given where necessary. The inside back cover of each volume contains a calendar of critical astronomical data to help explain the variations of the tide during each month and throughout the year.

3529. *Tide Predictions for Reference Stations*

For each day, the date and day of week are given, and the time and height of each high and low water are listed in chronological order. Although high and low waters are not labeled as such, they can be distinguished by the relative heights given immediately to the right of the times. If two high tides and two low tides occur each tidal day, the tide is semidiurnal. Since the tidal day is longer than the civil day (because of the revolution of the Moon eastward around the Earth), any given tide occurs later each day. Because of later times of corresponding tides from day to day, certain days have only one high water or only one low water.

3530. *Tide Predictions for Subordinate Stations*

For each subordinate station listed, the following information is given:

1. **Number.** The stations are listed in geographical order and assigned consecutive numbers. Each volume contains an alphabetical station listing correlating the station with its consecutive number to assist in finding the entry in Table 2.
2. **Place.** The list of places includes both subordinate and reference stations; the latter are in bold type.
3. **Position.** The approximate latitude and longitude are given to assist in locating the station. The latitude is

north or south, and the longitude east or west, depending upon the letters (N, S, E, W) next above the entry. These may not be the same as those at the top of the column.

4. **Differences.** The differences are to be applied to the predictions for the reference station, shown in capital letters above the entry. Time and height differences are given separately for high and low waters. Where differences are omitted, they are either unreliable or unknown.
5. **Ranges.** Various ranges are given, as indicated in the tables. In each case this is the difference in height between high water and low water for the tides indicated.
6. **Mean tide level.** This is the average between mean low and mean high water, measured from chart datum.

The **time difference** is the number of hours and minutes to be applied to the reference station time to find the time of the corresponding tide at the subordinate station. This interval is added if preceded by a plus sign (+) and subtracted if preceded by a minus sign (-). The results obtained by the application of the time differences will be in the zone time of the time meridian shown directly above the difference for the subordinate station. Special conditions occurring at a few stations are indicated by footnotes on the applicable pages. In some instances, the corresponding tide falls on a different date at reference and subordinate stations.

Height differences are shown in a variety of ways. For most entries, separate height differences in feet are given for high water and low water. These are applied to the height given for the reference station. In many cases a ratio is given for either high water or low water, or both. The height at the reference station is multiplied by this ratio to find the height at the subordinate station. For a few stations, both a ratio and difference are given. In this case the height at the reference station is first multiplied by the ratio, and the difference is then applied. An example is given in each volume of tide tables. Special conditions are indicated in the table or by footnote. For example, a footnote indicates that “Values for the Hudson River above George Washington Bridge are based upon averages for the six months May to October, when the fresh-water discharge is a minimum.”

3531. Finding Height of Tide at any Time

Table 3 provides means for determining the approximate height of tide at any time. It assumes that plotting height versus time yields a sine curve. Actual values may vary from this. The explanation of the table contains directions for both mathematical and graphical solutions. Though the mathematical solution is quicker, if the vessel’s ETA changes significantly, it will have to be done for the new ETA. Therefore, if there is doubt about the ETA, the graphical solution will provide a plot of predictions for several hours and allow quick reference to the predicted height

for any given time. This method will also quickly show at what time a given depth of water will occur. Figure 3531a shows the OPNAV form used to calculate heights of tides. Figure 3531b shows the importance of calculating tides in shallow water.

OPNAV 3530/40 (4-73)	
HT OF TIDE	
<hr/>	
Date	
<hr/>	
Location	
<hr/>	
Time	
<hr/>	
Ref Sta	
<hr/>	
HW Time Diff	
<hr/>	
LW Time Diff	
<hr/>	
HW Ht Diff	
<hr/>	
LW Ht Diff	
<hr/>	
Ref Sta	
HW/LW Time	
<hr/>	
HW/LW Time Diff	
<hr/>	
Sub Sta	
HW/LW Time	
<hr/>	
Ref Sta	
HW/LW Ht	
<hr/>	
HW/LW Ht Diff	
<hr/>	
Sub Sta	
HW/LW Ht	
<hr/>	
Duration	
Rise	
Fall	
<hr/>	
Time Fm	
Near	
Tide	
<hr/>	
Range of Tide	
<hr/>	
Ht of Neap Tide	
<hr/>	
Corr Table 3	
<hr/>	
Ht of Tide	
<hr/>	
Charted Depth	
<hr/>	
Depth of Water	
<hr/>	
Draft	
<hr/>	
Clearance	
<hr/>	

Figure 3531a. OPNAV 3530/40 Tide Form.

3532. Tidal Current Tables

Tidal Current Tables are somewhat similar to *Tide Tables*, but the coverage is less extensive. NOS publishes 2 volumes on an annual basis: Atlantic Coast of North America, and Pacific Coast of North America and Asia. Each of the two volumes is arranged as follows:

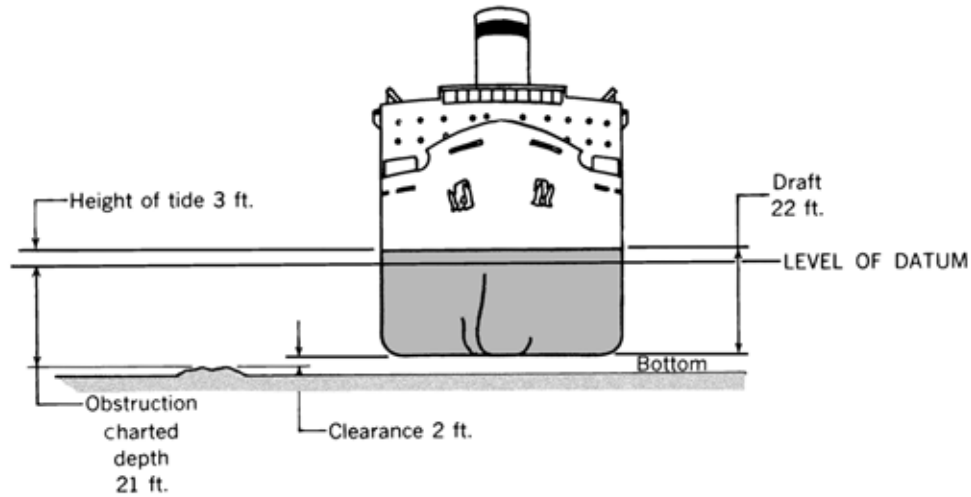

Figure 3531b. Height of tide required to pass clear of charted obstruction.

Each volume also contains current diagrams and instructions for their use. Explanations and examples are given in each table.

- **Table 1** contains a complete list of predicted times of maximum currents and slack water, with the velocity of the maximum currents, for a number of reference stations.
- **Table 2** gives differences, ratios, and other information related to a relatively large number of subordinate stations.
- **Table 3** provides information to determine the current's velocity at any time between entries in tables 1 and 2.
- **Table 4** gives duration of slack, or the number of minutes the current does not exceed stated amounts, for various maximum velocities.
- **Table 5** (Atlantic Coast of North America only) gives information on rotary tidal currents.

The volumes also contain general descriptive information on wind-driven currents, combination currents, and information such as Gulf Stream currents for the east coast and coastal currents on the west coast.

3533. Tidal Current Prediction for Reference Stations

For each day, the date and day of week are given; current information follows. If the cycle is repeated twice each tidal day, currents are semidiurnal. On most days there are four slack waters and four maximum currents, two floods (F) and two ebbs (E). However, since the tidal day is longer than the civil day, the corresponding condition occurs later each day, and on certain days there are only three slack waters or three maximum currents. At some places, the current on some days runs maximum flood twice, but ebbs only once, a minimum flood occurring in place of the second ebb. The

tables show this information.

3534. Tidal Current Predictions for Subordinate Stations

For each subordinate station listed in Table 2 of the tidal current tables, the following information is given:

1. **Number:** The stations are listed in geographical order and assigned consecutive numbers, as in the tide tables. Each volume contains an alphabetical station listing correlating the station with its consecutive number to assist in locating the entry in Table 2.
2. **Place:** The list of places includes both subordinate and reference stations, the latter given in bold type.
3. **Position:** The approximate latitude and longitude are given to assist in locating the station. The latitude is north or south and the longitude east or west as indicated by the letters (N, S, E, W) next above the entry. The current given is for the center of the channel unless another location is indicated by the station name.
4. **Time difference:** Two time differences are tabulated. One is the number of hours and minutes to be applied to the tabulated times of slack water at the reference station to find the times of slack waters at the subordinate station. The other time difference is applied to the times of maximum current at the reference station to find the times of the corresponding maximum current at the subordinate station. The intervals, which are added or subtracted in accordance with their signs, include any difference in time between the two stations, so that the answer is correct for the standard time of the subordinate station. Limited application and special conditions are indicated by

footnotes.

5. **Velocity ratios:** Speed of the current at the subordinate station is the product of the velocity at the reference station and the tabulated ratio. Separate ratios may be given for flood and ebb currents. Special conditions are indicated by footnotes.
6. **Average Speeds and Directions:** Minimum and maximum velocities before flood and ebb are listed for each station, along with the true directions of the flow. Minimum velocity is not always 0.0 knots.

3535. Finding Velocity of Tidal Current at any Time

Table 3 of the tidal current tables provides means for

OPNAV 3530/40 (4-73) VEL OF CURRENT	
Date	
Location	
Time	
Ref Sta	
Time Diff Stack Water	
Time Diff Max Current	
Vel Ratio Max Flood	
Vel Ratio Max Ebb	
Flood Dir	
Ebb Dir	
Ref Sta Stack Water Time	
Time Diff	
Local Sta Stack Water Time	
Ref Sta Max Current Time	
Time Diff	
Local Sta Max Current Time	
Ref Sta Max Current Vel	
Vel Ratio	
Local Sta Max Current Vel	

Figure 3535. OPNAV 3530/40 Tide Form.

OPNAV 3530/40 (4-73) VEL OF CURRENT	
Int Between Slack and Desired Time	
Int Between Slack and Max Current	
Max Current	
Factor Table 3	
Velocity	
Direction	

Figure 3535. OPNAV 3530/40 Tide Form.

determining the approximate velocity at any time. Directions are given in an explanation preceding the table. Figure 3535 shows the OPNAV form used for current prediction.

3536. Duration of Slack Water

The predicted times of slack water listed in the tidal current tables indicate the instant of zero velocity. There is a period each side of slack water, however, during which the current is so weak that for practical purposes it may be considered negligible. Table 4 of the tidal current tables gives, for various maximum currents, the approximate period of time during which currents not exceeding 0.1 to 0.5 knots will be encountered. This period includes the last of the flood or ebb and the beginning of the following flood or ebb; that is, half of the duration will be before and half after the time of slack water.

When there is a difference between the velocities of the maximum flood and ebb preceding and following the slack for which the duration is desired, it will be sufficiently accurate to find a separate duration for each maximum velocity and average the two to determine the duration of the weak current.

Of the two sub-tables of Table 4, Table A is used for all places except those listed for Table B; Table B is used for just the places listed and the stations in Table 2 which are referred to them.

3537. Additional Tide Prediction Publications

NOS also publishes a special *Regional Tide and Tidal Current Table for New York Harbor to Chesapeake Bay*, and a *Tidal Circulation and Water Level Forecast Atlas for Delaware River and Bay*.

3538. Tidal Current Charts

Tidal Current charts present a comprehensive view of the hourly velocity of current in different bodies of water. They also provide a means for determining the current's velocity at various locations in these waters. The arrows show the direction of the current; the figures give the speed in

knots at the time of spring tides. A weak current is defined as less than 0.1 knot. These charts depict the flow of the tidal current under normal weather conditions. Strong winds and freshets, however, may cause nontidal currents, considerably modifying the velocity indicated on the charts.

Tidal Current charts are provided for Boston Harbor, Charleston Harbor SC, Long Island Sound and Block Island Sound, Narragansett Bay, Narragansett Bay to Nantucket Sound, Puget Sound (Northern Part), Puget Sound (Southern Part), Upper Chesapeake Bay, and Tampa Bay.

The tidal current's velocity varies from day to day as a function of the phase, distance, and declination of the Moon. Therefore, to obtain the velocity for any particular day and hour, the spring velocities shown on the charts must be modified by correction factors. A correction table given in the charts can be used for this purpose.

All of the charts except Narragansett Bay require the use of the annual *Tidal Current Tables*. Narragansett Bay requires use of the annual *Tide Tables*.

3539. Current Diagrams

A current diagram is a graph showing the velocity of the current along a channel at different stages of the tidal current cycle. The current tables include diagrams for Martha's Vineyard and Nantucket Sounds (one diagram); East River, New York; New York Harbor; Delaware Bay and River (one diagram); and Chesapeake Bay. These diagrams are no longer published by NOS, but are available privately and remain useful as they are not ephemeral.

On Figure 3539, each vertical line represents a given instant identified by the number of hours before or after slack water at The Narrows. Each horizontal line represents a distance from Ambrose Channel entrance, measured along the usually traveled route. The names along the left margin are placed at the correct distances from Ambrose Channel entrance. The current is for the center of the channel opposite these points. The intersection of any vertical line with any horizontal line represents a given moment in the current cycle at a given place in the channel. If this intersection is in a shaded area, the current is flooding; if in an unshaded area, it is ebbing. The velocity can be found by interpolation between the numbers given in the diagram. The given values are averages. To find the value at any time, multiply the velocity found from the diagram by the ratio of maximum velocity of the current involved to the maximum shown on the diagram. If the diurnal inequality is large, the accuracy can be improved by altering the width of the shaded area to fit conditions. The diagram covers 1 1/2 current cycles, so that the right 1/3 duplicates the left 1/3.

Use Table 1 or 2 to determine the current for a single station. The current diagrams are intended for use in either of two ways: to determine a favorable time for passage through the channel and to find the average current to be expected during a passage through the channel. For both of

these uses, a number of "velocity lines" are provided. When the appropriate line is transferred to the correct part of the diagram, the current to be encountered during passage is indicated along the line.

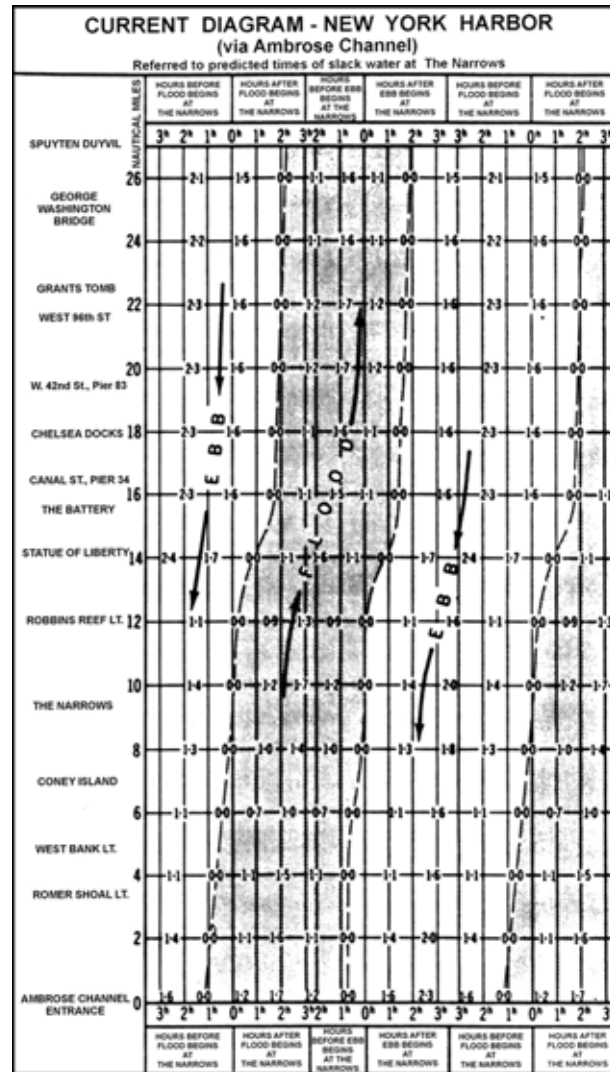

Figure 3539. Current diagram for New York Harbor.

If the transferred velocity line is partly in a flood current area, all ebb currents (those increasing the ship's velocity) are given a positive sign (+), and all flood currents a negative sign (-). A separate ratio should be determined for each current (flood or ebb), and applied to the entries for that current. In the Chesapeake Bay, it is common for an outbound vessel to encounter three or even four separate currents during passage. Under the latter condition, it is good practice to multiply each current taken from the diagram by the ratio for the current involved.

If the time of starting the passage is fixed, and the current during passage is desired, the starting time is identified in terms of the reference tidal cycle. The velocity line is then drawn through the intersection of this vertical time line and the horizontal line through the place. The

average current is then determined in the same manner as when the velocity line is located as described above.

3540. Computer Predictions

Until recently, tidal predictions were compiled only on mainframe or minicomputers and then put into hardcopy table form for the mariner. There are several types of commercial software available now for personal computers (PC's) that provide digital versions of the NOS tide tables and also graph the tidal heights. The tabular information and graphs can be printed for the desired locations for pre-voyage planning. There are also several types of specialized hand-held calculators and tide clocks that can be used to predict tides for local areas.

Newer versions of PC software use the actual harmonic

constants available for locations, the prediction equation, and digital versions of Table 2 in the *Tide Tables* to produce even more products for the navigator's use. Since NOS has published the data, even inexpensive navigation electronics such as handheld GPS receivers and plotters for small craft navigation often include graphic tide tables.

Emerging applications include integration of tidal prediction with positioning systems and vessel traffic systems which are now moving towards full use of GPS. In addition, some electronic chart systems are already able to integrate tide prediction information. Many of these new systems will also use real-time water level and current information. Active research also includes providing predictions of total water level that will include not only the tidal prediction component, but also the weather-related component.

CHAPTER 36

OCEAN CURRENTS

TYPES AND CAUSES OF CURRENTS

3600. Definitions

The movement of ocean water is one of the two principal sources of discrepancy between dead reckoned and actual positions of vessels (the other source is the wind). Water in motion is called a current; the direction toward which it moves is called **set**, and its speed is called **drift**. Modern shipping speeds have lessened the impact of currents on a typical voyage, and since electronic navigation allows continuous adjustment of course, there is less need to estimate current set and drift before setting the course to be steered. Nevertheless, a knowledge of ocean currents can be used in cruise planning to reduce transit times, and current models are an integral part of ship routing systems.

Oceanographers have developed a number of methods of classifying currents in order to facilitate descriptions of their physics and geography. Currents may be referred to according to their forcing mechanism as either **wind driven** or **thermohaline**. Alternatively, they may be classified according to their depth (surface, intermediate, deep or bottom). The surface circulation of the world's oceans is mostly wind driven. Thermohaline currents are driven by differences in heat and salt and are associated with the sinking of dense water at high latitudes; the currents driven by thermohaline forces are typically subsurface. Note that this classification scheme is not unambiguous; the circumpolar current, which is wind driven, extends from the surface to the bottom.

A **periodic current** is one for which the speed or direction changes cyclically at somewhat regular intervals, such as a tidal current. A **seasonal current** is one which changes in speed or direction due to seasonal winds. The mean circulation of the ocean consists of semi-permanent currents which experience relatively little periodic or seasonal change.

A **coastal current** flows roughly parallel to a coast, outside the surf zone, while a **longshore current** is one parallel to a shore, inside the surf zone, generated by waves striking the beach at an angle. Any current some distance from the shore may be called an **offshore current**, and one close to the shore an **inshore current**.

General information on ocean currents is available from NOAA's National Center for Environmental Information (NCEI), formerly the National Ocean Data Center (NODC). See Figure 3600 for a link to the NCEI website.



Figure 3600. NOAA's National Center for Environmental Information (NCEI) formerly the National Ocean Data Center (NODC).

<https://www.nodc.noaa.gov/General/current.html>

3601. Causes of Ocean Currents

The primary generating forces of ocean currents are wind and differences in water density caused by variations in heat and salinity. Currents generated by these forces are modified by such factors as depth of water, underwater topography (including shape of the basin in which the current is running), extent & location of land and deflection by the rotation of the Earth.

3602. Wind Driven Currents

The friction or stress of wind blowing across the sea causes a surface layer of water to move. Due to the low viscosity of water, this stress is not directly communicated to the ocean interior, but is balanced by the Coriolis force within a relatively thin surface layer, 10-200m thick. This layer is called the **Ekman layer** and the motion of this layer is called the **Ekman transport**. Because of the deflection by the Coriolis force, the Ekman transport is not in the direction of the wind, but is 90° to the right in the Northern Hemisphere and 90° toward the left in the Southern Hemisphere. The amount of water flowing in this layer depends only upon the wind and the Coriolis force. It is independent of the depth of the Ekman layer and the viscosity of the water.

The large scale convergence or divergence of Ekman transport serves to drive the general ocean circulation. Consider the case of the Northern Hemisphere subtropics. To the south lie easterly winds (**Trade Winds**) with associated northward Ekman transport. To the north lie westerly winds with southward Ekman transport. The convergence of these Ekman transports is called **Ekman**

pumping and results in a thickening of the upper ocean and a increase in the depth of the thermocline. The resulting subsurface pressure gradients, balanced by the Coriolis force, give rise to the anticyclonic subtropical gyres found at mid latitudes in each ocean basin. In subpolar regions, Ekman suction produces cyclonic gyres.

These wind driven gyres are not symmetrical. Along the western boundary of the oceans, currents are narrower, stronger, and deeper, often following a meandering course. These currents are sometimes called a **stream**, i.e. the Gulf Stream in the Atlantic Ocean. In contrast, currents in mid-ocean and at the eastern boundary, are often broad, shallow and slow-moving. Sometimes these are called **drift currents**.

Within the Ekman layer, the currents actually form a spiral. At the surface, the difference between wind direction and surface wind-current direction varies from about 15° along shallow coastal areas to a maximum of 45° in the deep oceans. As the motion is transmitted to successively deep layers, the Coriolis force continues to deflect the current. At the bottom of the Ekman layer, the current flows in the opposite direction to the surface current. This shift of current directions with depth, combined with the decrease in velocity with depth, is called the **Ekman spiral**.

The velocity of the surface current is the sum of the velocities of the Ekman, geostrophic, tidal, and other currents. The Ekman surface current or wind drift current depends upon the speed of the wind, its constancy, the

length of time it has blown, and other factors. In general, however, wind drift current is about 2 percent of the wind speed, or a little less, in deep water where the wind has been blowing steadily for at least 12 hours.

3603. Currents Related to Density Differences

The density of water varies with salinity, temperature, and pressure. At any given depth, the differences in density are due only to differences in temperature and salinity. With sufficient data, maps showing geographical density distribution at a certain depth can be drawn, with lines connecting points of equal density. These lines would be similar to isobars on a weather map and serve an analogous purpose, showing areas of high density and those of low density. In an area of high density, the water surface is lower than in an area of low density, the maximum difference in height being about 1 meter in 100 km. Because of this difference, water tends to flow from an area of higher water (low density) to one of lower water (high density). But due to rotation of the Earth, it is deflected by the Coriolis force or toward the right in the Northern Hemisphere, and toward the left in the Southern Hemisphere. This balance, between subsurface pressure fields and the Coriolis force, is called **geostrophic equilibrium**. At a given latitude, the greater the density gradient (rate of change with distance), the faster the geostrophic current.

OCEANIC CIRCULATION

3604. Introduction

A number of ocean currents flow with great persistence, setting up a circulation that continues with relatively little change throughout the year. Because of the influence of wind in creating current, there is a relationship between this oceanic circulation and the general circulation of the atmosphere. The oceanic circulation is shown on the Stream Drift Chart of the World insert (winter N. hemisphere), with the names of the major ocean currents. Some differences in opinion exist regarding the names and limits of some of the currents, but those shown are representative. Speed may vary somewhat with the season. This is particularly noticeable in the Indian Ocean and along the South China coast, where currents are influenced to a marked degree by the monsoons.

3605. Southern Ocean Currents

The Southern Ocean has no meridional boundaries and its waters are free to circulate around the globe. It serves as a conveyor belt for the other oceans, exchanging waters between them. The northern boundary of the Southern Ocean is marked by the Subtropical Convergence zone. This zone marks the transition from the temperate region of

the ocean to the polar region and is associated with the surfacing of the main thermocline. This zone is typically found at 40°S but varies with longitude and season.

In the Antarctic, the circulation is generally from west to east in a broad, slow-moving current extending completely around Antarctica. This is called the **Antarctic Circumpolar Current** or the **West Wind Drift**, and it is formed partly by the strong westerly wind in this area, and partly by density differences. This current is augmented by the Brazil and Falkland Currents in the Atlantic, the East Australia Current in the Pacific, and the Agulhas Current in the Indian Ocean. In return, part of it curves northward to form the Cape Horn, Falkland, and most of the Benguela Currents in the Atlantic, and the Peru Current in the Pacific.

In a narrow zone next to the Antarctic continent, a westward flowing coastal current is usually found. This current is called the **East Wind Drift** because it is attributed to the prevailing easterly winds, which occur there.

3606. Atlantic Ocean Currents

The trade winds set up a system of equatorial currents which at times extends over as much as 50° of latitude or more. There are two westerly flowing currents conforming

generally with the areas of trade winds, separated by a weaker, easterly flowing countercurrent.

The **North Equatorial Current** originates to the northward of the Cape Verde Islands and flows almost due west at an average speed of about 0.7 knot.

The **South Equatorial Current** is more extensive. It starts off the west coast of Africa, south of the Gulf of Guinea, and flows in a generally westerly direction at an average speed of about 0.6 knot. However, the speed gradually increases until it may reach a value of 2.5 knots, or more, off the east coast of South America. As the current approaches Cabo de Sao Roque, the eastern extremity of South America, it divides, the southern part curving toward the south along the coast of Brazil, and the northern part being deflected northward by the continent of South America.

Between the North and South Equatorial Currents, the weaker **North Equatorial Countercurrent** sets toward the east in the general vicinity of the doldrums. This is fed by water from the two westerly flowing equatorial currents, particularly the South Equatorial Current. The extent and strength of the Equatorial Countercurrent changes with the seasonal variations of the wind. It reaches a maximum during July and August, when it extends from about 50° west longitude to the Gulf of Guinea. During its minimum, in December and January, it is of very limited extent, the western portion disappearing altogether.

That part of the South Equatorial Current flowing along the northern coast of South America, which does not feed the Equatorial Countercurrent, unites with the North Equatorial Current at a point west of the Equatorial Countercurrent. A large part of the combined current flows through various passages between the Windward Islands and into the Caribbean Sea. It sets toward the west, and then somewhat north of west, finally arriving off the Yucatan peninsula. From there, the water enters the Gulf of Mexico and forms the **Loop Current**; the path of the Loop Current is variable with a 13-month period. It begins by flowing directly from Yucatan to the Florida Straits, but gradually grows to flow anticyclonically around the entire Eastern Gulf; it then collapses, again following the direct path from Yucatan to the Florida Straits, with the loop in the Eastern Gulf becoming a separate eddy which slowly flows into the Western Gulf.

Within the Straits of Florida, the Loop Current feeds the beginnings of the most remarkable of American ocean currents, the **Gulf Stream**. Off the southeast coast of Florida this current is augmented by the **Antilles Current** which flows along the northern coasts of Puerto Rico, Hispaniola, and Cuba. Another current flowing eastward of the Bahamas joins the stream north of these islands.

The Gulf Stream follows generally along the east coast of North America, flowing around Florida, northward and then northeastward toward Cape Hatteras, and then curving toward the east and becoming broader and slower. After passing the Grand Banks, it turns more toward the north and

becomes a broad drift current flowing across the North Atlantic. The part in the Straits of Florida is sometimes called the **Florida Current**.

A tremendous volume of water flows northward in the Gulf Stream. It can be distinguished by its deep indigo-blue color, which contrasts sharply with the dull green of the surrounding water. It is accompanied by frequent squalls. When the Gulf Stream encounters the cold water of the Labrador Current, principally in the vicinity of the Grand Banks, there is little mixing of the waters. Instead, the junction is marked by a sharp change in temperature. The line or surface along which this occurs is called the **cold wall**. When the warm Gulf Stream water encounters cold air, evaporation is so rapid that the rising vapor may be visible as frost smoke.

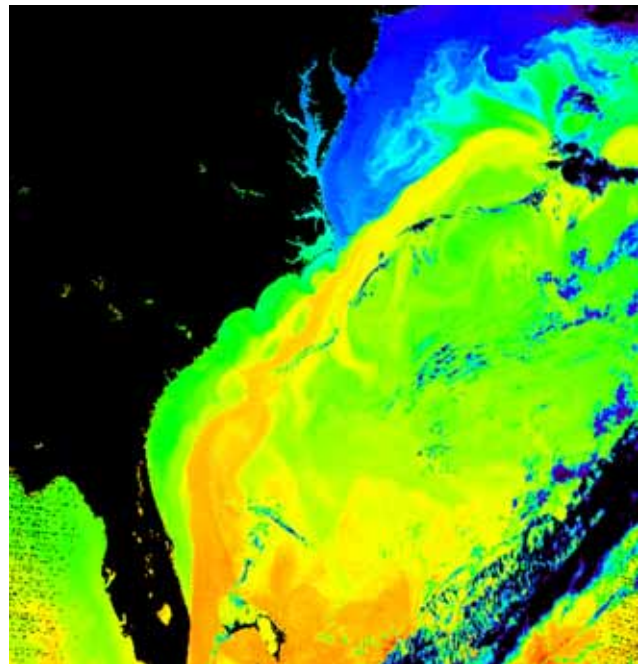

Figure 3606a. Infrared image of the warm water Gulf Stream running northwards along the U.S. East Coast.

Investigations have shown that the current itself is much narrower and faster than previously supposed, and considerably more variable in its position and speed. The maximum current off Florida ranges from about 2 to 4 knots. Northward, the speed is generally less, and it decreases further after the current passes Cape Hatteras. As the stream meanders and shifts position, eddies sometimes break off and continue as separate, circular flows until they dissipate. Vessels in the Newport-Bermuda sailing yacht race have been known to be within sight of each other and be carried in opposite directions by different parts of the same current. This race is generally won by the boat which catches an eddy just right. As the current shifts position, its extent does not always coincide with the area of warm, blue water. When the sea is relatively smooth, the edges of the

current are marked by ripples.

A recirculation region exists adjacent to and southeast of the Gulf Stream. The flow of water in the recirculation region is opposite to that in the Gulf Stream and surface currents are much weaker, generally less than half a knot.

As the Gulf Stream continues eastward and northeastward beyond the Grand Banks, it gradually widens and decreases speed until it becomes a vast, slow-moving current known as the **North Atlantic Current**, in the general vicinity of the prevailing westerlies. In the eastern part of the Atlantic it divides into the **Northeast Drift Current** and the **Southeast Drift Current**.

The Northeast Drift Current continues in a generally northeasterly direction toward the Norwegian Sea. As it does so, it continues to widen and decrease speed. South of Iceland it branches to form the **Irminger Current** and the **Norway Current**. The Irminger Current curves toward the north and northwest to join the East Greenland Current southwest of Iceland. The Norway Current continues in a northeasterly direction along the coast of Norway. Part of it, the **North Cape Current**, rounds North Cape into the Barents Sea. The other part curves toward the north and becomes known as the **Spitsbergen Current**. Before reaching Svalbard (Spitsbergen), it curves toward the west and joins the cold **East Greenland Current** flowing southward in the Greenland Sea. As this current flows past Iceland, it is further augmented by the Irminger Current.

Off Kap Farvel, at the southern tip of Greenland, the East Greenland Current curves sharply to the northwest following the coastline. As it does so, it becomes known as the **West Greenland Current**, and its character changes from that of an intense western boundary current to a weaker eastern boundary current. This current continues along the west coast of Greenland, through Davis Strait, and into Baffin Bay.

In Baffin Bay the West Greenland Current generally follows the coast, curving westward off Kap York to form the southerly flowing **Labrador Current**. This cold current flows southward off the coast of Baffin Island, through Davis Strait, along the coast of Labrador and Newfoundland, to the Grand Banks, carrying with it large quantities of ice. Here it encounters the warm water of the Gulf Stream, creating the cold wall. Some of the cold water flows southward along the east coast of North America, inshore of the Gulf Stream, as far as Cape Hatteras. The remainder curves toward the east and flows along the northern edge of the North Atlantic and Northeast Drift Currents, gradually merging with them.

The **Southeast Drift Current** curves toward the east, southeast, and then south as it is deflected by the coast of Europe. It flows past the Bay of Biscay, toward southeastern Europe and the Canary Islands, where it continues as the **Canary Current**. In the vicinity of the Cape Verde Islands, this current divides, part of it curving toward the west to help form the **North Equatorial Current**, and part of it curving toward the east to follow the coast of Africa into the Gulf of Guinea, where it is known as the **Guinea Current**. This current is augmented by the **North Equatorial Counter-current** and, in summer, it is strengthened by monsoon winds. It flows in close proximity to the South Equatorial Current, but in the opposite direction. As it curves toward the south, still following the African coast, it merges with the South Equatorial Current.

The clockwise circulation of the North Atlantic leaves a large central area between the recirculation region and the Canary Current which has no well-defined currents. This area is known as the **Sargasso Sea**, from the large quantities of sargasso or gulfweed encountered there. See Figure 3606b.



Figure 3606b. The Sargasso Sea, located entirely within the Atlantic Ocean, is the only sea without a land boundary.

That branch of the South Equatorial Current, which curves toward the south off the east coast of South America, follows the coast as the warm, highly-saline **Brazil**

Current, which in some respects resembles a weak Gulf Stream. Off Uruguay it encounters the colder, less-salty **Falkland** or **Malvinas Current** forming a sharp

meandering front in which eddies may form. The two currents curve toward the east to form the broad, slow-moving, **South Atlantic Current** in the general vicinity of the prevailing westerlies and the front dissipates somewhat. This current flows eastward to a point west of the Cape of Good Hope, where it curves northward to follow the west coast of Africa as the strong **Benguela Current**, augmented somewhat by part of the **Agulhas Current** flowing around the southern part of Africa from the Indian Ocean. As it continues northward, the current gradually widens and slows. At a point east of St. Helena Island it curves westward to continue as part of the South Equatorial Current, thus completing the counterclockwise circulation of the South Atlantic. The Benguela Current is also augmented somewhat by the **West Wind Drift**, a current which flows easterly around Antarctica. As the West Wind Drift flows past Cape Horn, that part in the immediate vicinity of the cape is called the **Cape Horn Current**. This current rounds the cape and flows in a northerly and northeasterly direction along the coast of South America as the Falkland or Malvinas Current.

3607. Pacific Ocean Currents

Pacific Ocean currents follow the general pattern of those in the Atlantic. The **North Equatorial Current** flows westward in the general area of the northeast trades and the **South Equatorial Current** follows a similar path in the region of the southeast trades. Between these two, the weaker **North Equatorial Countercurrent** sets toward the east, just north of the equator.

After passing the Mariana Islands, the major part of the North Equatorial Current curves somewhat toward the northwest, past the Philippines and Taiwan. Here it is deflected further toward the north, where it becomes known as the **Kuroshio**, and then toward the northeast past the Nansei Shoto and Japan, and on in a more easterly direction. Part of the Kuroshio, called the **Tsushima Current**, flows through Tsushima Strait, between Japan and Korea, and the Sea of Japan, following generally the northwest coast of Japan. North of Japan it curves eastward and then southeastward to rejoin the main part of the Kuroshio. The limits and volume of the Kuroshio are influenced by the monsoons, being augmented during the season of southwesterly winds, and diminished when the northeasterly winds are prevalent.

The Kuroshio (Japanese for "Black Stream") is so named because of the dark color of its water. It is sometimes called the **Japan Current**. In many respects it is similar to the Gulf Stream of the Atlantic. Like that current, it carries large quantities of warm tropical water to higher latitudes, and then curves toward the east as a major part of the general clockwise circulation in the Northern Hemisphere. As it does so, it widens and slows, continuing on between the Aleutians and the Hawaiian Islands, where it becomes known as the **North Pacific Current**.

As this current approaches the North American continent, most of it is deflected toward the right to form a clockwise circulation between the west coast of North America and the Hawaiian Islands called the **California Current**. This part of the current has become so broad that the circulation is generally weak. Near the coast, the southeastward flow intensifies and average speeds are about 0.8 knot. But the flow pattern is complex, with offshore directed jets often found near more prominent capes, and poleward flow often found over the upper slope and outer continental shelf. It is strongest near land. Near the southern end of Baja California, this current curves sharply to the west and broadens to form the major portion of the North Equatorial Current.

During the winter, a weak countercurrent flows northwestward, inshore of the southeastward flowing California Current, along the west coast of North America from Baja California to Vancouver Island. This is called the **Davidson Current**.

Off the west coast of Mexico, south of Baja California the current flows southeastward during the winter as a continuation of part of the California Current. During the summer, the current in this area is northwestward as a continuation of the North Equatorial Countercurrent.

As in the Atlantic, there is in the Pacific a counterclockwise circulation to the north of the clockwise circulation. Cold water flowing southward through the western part of Bering Strait between Alaska and Siberia, is joined by water circulating counterclockwise in the Bering Sea to form the **Oyashio**. As the current leaves the strait, it curves toward the right and flows southwesterly along the coast of Siberia and the Kuril Islands. This current brings quantities of sea ice, but no icebergs. When it encounters the Kuroshio, the Oyashio curves southward and then eastward, the greater portion joining the Kuroshio and North Pacific Current.

The northern branch of the North Pacific Current curves in a counterclockwise direction to form the **Alaska Current**, which generally follows the coast of Canada and Alaska. When the Alaska Current turns to the southwest and flows along the Kodiak Island and the Alaska Peninsula, its character changes to that of a western boundary current and it is called the **Alaska Stream**. When this westward flow arrives off the Aleutian Islands, it is less intense and becomes known as the **Aleutian Current**. Part of it flows along the southern side of these islands to about the 180th meridian, where it curves in a counterclockwise direction and becomes an easterly flowing current, being augmented by the northern part of the Oyashio. The other part of the Aleutian Current flows through various openings between the Aleutian Islands, into the Bering Sea. Here it flows in a general counterclockwise direction. The southward flow along the Kamchatka peninsula is called the **Kamchatka Current** which feeds the southerly flowing Oyashio. Some water flows northward from the Bering Sea through the eastern side of the Bering Strait, into the Arctic Ocean.

The **South Equatorial Current**, extending in width between about 4°N latitude and 10°S, flows westward from South America to the western Pacific. After this current crosses the 180th meridian, the major part curves in a counterclockwise direction, entering the Coral Sea, and then curving more sharply toward the south along the east coast of Australia, where it is known as the **East Australian Current**. The East Australian Current is the weakest of the subtropical western boundary currents and separates from the Australian coast near 34°S. The path of the current from Australia to New Zealand is known as the **Tasman Front**, which marks the boundary between the warm water of the Coral Sea and the colder water of the Tasman Sea. The continuation of the East Australian Current east of New Zealand is the **East Auckland Current**. The East Auckland Current varies seasonally. In the winter, it separates from the shelf and flows eastward, merging with the West Wind Drift, while in winter it follows the New Zealand shelf southward as the **East Cape Current** until it reaches Chatham Rise where it turns eastward, thence merging with the West Wind Drift.

Near the southern extremity of South America, most of this current flows eastward into the Atlantic, but part of it curves toward the left and flows generally northward along the west coast of South America as the **Peru Current** or **Humboldt Current**. Occasionally a set directly toward land is encountered. At about Cabo Blanco, where the coast falls away to the right, the current curves toward the left, past the Galapagos Islands, where it takes a westerly set and constitutes the major portion of the South Equatorial Current, thus completing the counterclockwise circulation of the South Pacific.

During the northern hemisphere summer, a weak northern branch of the South Equatorial Current, known as the **New Guinea Coastal Current**, continues on toward the west and northwest along both the southern and northeastern coasts of New Guinea. The southern part flows through Torres Strait, between New Guinea and Australia, into the Arafura Sea. Here, it gradually loses its identity, part of it flowing on toward the west as part of the South Equatorial Current of the Indian Ocean, and part of it following the coast of Australia and finally joining the easterly flowing West Wind Drift. The northern part of New Guinea Coastal Current, both curves in a clockwise direction to help form the Pacific Equatorial Countercurrent and off Mindanao, turns southward to form a southward flowing boundary current called the **Mindanao Current**. During the northern hemisphere winter, the New Guinea Coastal Current may reverse direction for a few months.

3608. Indian Ocean Currents

Indian Ocean currents follow generally the pattern of the Atlantic and Pacific but with differences caused principally by the monsoons, the more limited extent of water in the Northern Hemisphere, and by limited communication with

the Pacific Ocean along the eastern boundary. During the northern hemisphere winter, the **North Equatorial Current** and **South Equatorial Current** flow toward the west, with the weaker, eastward **Equatorial Countercurrent** flowing between them, as in the Atlantic and Pacific (but somewhat south of the equator). But during the northern hemisphere summer, both the North Equatorial Current and the Equatorial Countercurrent are replaced by the **Southwest Monsoon Current**, which flows eastward and southeastward across the Arabian Sea and the Bay of Bengal. Near Sumatra, this current curves in a clockwise direction and flows westward, augmenting the South Equatorial Current, and setting up a clockwise circulation in the northern part of the Indian Ocean. Off the coast of Somalia, the **Somali Current** reverses direction during the northern hemisphere summer with northward currents reaching speeds of 5 knots or more. Twice a year, around May and November, westerly winds along the equator result in an eastward **Equatorial Jet** which feeds warm water towards Sumatra.

As the South Equatorial Current approaches the coast of Africa, it curves toward the southwest, part of it flowing through the Mozambique Channel between Madagascar and the mainland, and part flowing along the east coast of Madagascar. At the southern end of this island the two join to form the strong **Agulhas Current**, which is analogous to the Gulf Stream. This current, when opposed by strong winds from Southern Ocean storms, creates dangerously large seas.

South of South Africa, the Agulhas Current retroflects, and most of the flow curves sharply southward and then eastward to join the West Wind Drift; this junction is often marked by a broken and confused sea, made much worse by westerly storms. A small part of the Agulhas Current rounds the southern end of Africa and helps form the **Benguela Current**; occasionally, strong eddies are formed in the retroflexion region and these too move into the Southeastern Atlantic.

The eastern boundary currents in the Indian Ocean are quite different from those found in the Atlantic and Pacific. The seasonally reversing **South Java Current** has strongest westward flow during August when monsoon winds are easterly and the Equatorial jet is inactive. Along the coast of Australia, a vigorous poleward flow, the **Leeuwin Current**, runs against the prevailing winds.

3609. Arctic Currents

The waters of the North Atlantic enter the Arctic Ocean between Norway and Svalbard. The currents flow easterly, north of Siberia to the region of the Novosibirskiye Ostrova where they turn northerly across the North Pole and continue down the Greenland coast to form the **East Greenland Current**. On the American side of the Arctic basin, there is a weak, continuous clockwise flow centered in the vicinity of 80°N, 150°W. A current north through

Bering Strait along the American coast is balanced by an outward southerly flow along the Siberian coast, which eventually becomes part of the **Kamchatka Current**. Each of the main islands or island groups in the Arctic, as far as is known, seems to have a clockwise nearshore circulation

around it. The Barents Sea, Kara Sea, and Laptev Sea each have a weak counterclockwise circulation. A similar but weaker counterclockwise current system appears to exist in the East Siberian Sea.

OCEANIC CURRENT PHENOMENA

3610. Ocean Eddies and Rings

Eddies with horizontal diameters varying from 50-150 km have their own pattern of surface currents. These features may have either a warm or a cold core and currents flow around this core, either cyclonically for cold cores or anticyclonically for warm cores. The most intense of these features are called **rings** and are formed by the pinching off of meanders of western boundary currents such as the Gulf Stream. Maximum speed associated with these features is about 2 knots. Rings have also been observed to pinch off from the Agulhas retroflexion and to then drift to the northwest into the South Atlantic. Similarly, strong anticyclonic eddies are occasionally spawned by the loop current into the Western Gulf Mexico.

In general, **mesoscale** variability is strongest in the region of western boundary currents and in the Circumpolar Current. The strength of mesoscale eddies is greatly reduced at distances of 200-400 km from these strong boundary currents, because mean currents are generally weaker in these regions. The eddies may be sufficiently strong to reverse the direction of the surface currents.

3611. Undercurrents

At the equator and along some ocean boundaries, shallow undercurrents exist, flowing in a direction counter to that at the surface. These currents may affect the operation of submarines or trawlers. The most intense of these flows, called the **Pacific Equatorial Undercurrent**, is found at the equator in the Pacific. It is centered at a depth of 150m to the west of the Galapagos, is about 4 km wide, and eastward speeds of up to 1.5 m/s have been observed. Equatorial Undercurrents are also observed in the Atlantic and Indian Ocean, but they are somewhat weaker. In the Atlantic, the Equatorial Undercurrent is found to the east of 24°W and in the Indian Ocean, it appears to be seasonal.

Undercurrents also exist along ocean boundaries. They seem to be most ubiquitous at the eastern boundary of oceans. Here they are found at depths of 100-200m and may be 100 km wide, and have maximum speeds of 0.5 m/s.

3612. Ocean Currents and Climate

Many of the ocean currents exert a marked influence upon the climate of the coastal regions along which they flow. Thus, warm water from the Gulf Stream, continuing as the North Atlantic, Northeast Drift, and Irminger

Currents, arrives off the southwest coast of Iceland, warming it to the extent that Reykjavik has a higher average winter temperature than New York City, far to the south. Great Britain and Labrador are about the same latitude, but the climate of Great Britain is much milder because of the relatively warm currents. The west coast of the United States is cooled in the summer by the California Current, and warmed in the winter by the Davidson Current. Partly as a result of this circulation, the range of monthly average temperature is comparatively small.

Currents exercise other influences besides those on temperature. The pressure pattern is affected materially, as air over a cold current contracts as it is cooled, and that over a warm current expands. As air cools above a cold ocean current, fog is likely to form. Frost smoke occurs over a warm current which flows into a colder region. Evaporation is greater from warm water than from cold water, adding to atmospheric moisture.

3613. Ocean Current Observations

Historically, our views of the surface circulation of the ocean have been shaped by reports of ocean currents provided by mariners. These observations consist of reports of the difference between the dead reckoning and the observed position of the vessel. These observations were routinely collected until the start of World War II.

Today, three observation systems are generally used for surface current studies. The first utilizes **autonomous free-drifting buoys** which are tracked by satellite or relay their position via satellite. These buoys consist of either a spherical or cylindrical surface float which is about 0.5m in diameter with a drogue at a depth of about 35m.

The second system utilizes acoustic Doppler current profilers. These profilers utilize hull mounted transducers, operate at a frequency of 150 kHz, and have pulse repetition rates of about 1 second. They can penetrate to about 300m, and, where water is shallower than this depth, track the bottom. Merchant and naval vessels are increasingly being outfitted with acoustic Doppler current profilers which, when operated with the Global Positioning System, provide accurate observations of currents.

The third system is a high frequency radar system employing land-based radar antennae that can measure surface currents (top ~2m) up to 200 km from shore. These observations are available in near-real time to the mariner with an internet connection.

3614. References

OCTOBER 1977), SCIENCE, Vol. 198, Issue 4313,
Surface Currents Mapped by Radar, pp. 138-144.

Barrick, D. E., Evans, M. W., and Weber B. L., (14

CHAPTER 37

WAVES, BREAKERS AND SURF

OCEAN WAVES

3700. Introduction

Ocean waves, the most easily observed phenomenon at sea, are probably the least understood by the average seaman. More than any other single factor, ocean waves are likely to cause a navigator to change course or speed to avoid damage to ship and cargo. Wind-generated ocean waves have been measured at more than 100 feet high, and tsunamis, caused by earthquakes, far higher. Mariners with knowledge of basic facts concerning waves are able to use them to their advantage, avoid hazardous conditions, and operate with a minimum of danger if such conditions cannot be avoided. See Chapter 41 - Weather Routing, for details on how to avoid areas of severe waves.

3701. Causes of Waves

Waves on the surface of the sea are caused principally by wind, but other factors, such as submarine earthquakes, volcanic eruptions, and the tide, also cause waves. If a breeze of less than 2 knots starts to blow across smooth water, small wavelets called **ripples (capillary waves)** form almost instantaneously. When the breeze dies, the ripples disappear as suddenly as they formed, the level surface being restored by surface tension of the water. If the wind speed exceeds 2 knots, more stable **gravity waves** gradually form, and progress with the wind.

While the generating wind blows, the resulting waves may be referred to as **sea**. When the wind stops or changes direction, waves that continue on without relation to local winds are called **swell**.

Unlike wind and current, waves are not deflected appreciably by the rotation of the Earth, but move in the direction in which the generating wind blows. When this wind ceases, friction and spreading cause the waves to be reduced in height, or attenuated, as they move. However, the reduction takes place so slowly that swell often continues until it reaches some obstruction, such as a shore.

The Fleet Numerical Meteorology and Oceanography Center (FNMOC) produces synoptic analyses and predictions of ocean wave heights using a spectral numerical model. The wave information consists of heights and directions for different periods and wavelengths. Verification of projected data has proven the model to be very good. Information from the model is provided to the U.S. Navy on a routine basis and is a vital input to the Optimum Track Ship Routing (OTSR)

program.

3702. Wave Characteristics

Ocean waves are very nearly in the shape of an inverted cycloid, the figure formed by a point inside the rim of a wheel rolling along a level surface. This shape is shown in Figure 3702a. The highest parts of waves are called **crests**, and the intervening lowest parts, **troughs**. Since the crests are steeper and narrower than the troughs, the mean or still water level is a little lower than halfway between the crests and troughs. The vertical distance between trough and crest is called **wave height**, labeled H in Figure 3702a. The horizontal distance between successive crests, measured in the direction of travel, is called **wavelength**, labeled L. The time interval between passage of successive crests at a stationary point is called **wave period (P)**. Wave height, length, and period depend upon a number of factors, such as the wind speed, the length of time it has blown, and its **fetch** (the straight distance it has traveled over the surface). Table 3702b indicates the relationship between wind speed, fetch, length of time the wind blows, wave height, and wave period in deep water.



Figure 3702a. A typical sea wave.

If the water is deeper than one-half the wavelength (L), this length in feet is theoretically related to period (P) in seconds by the formula:

$$L = 5.12 P^2.$$

The actual value has been found to be a little less than this for swell, and about two-thirds the length determined by this formula for sea. When the waves leave the generating area and continue as free waves, the wavelength and period continue to increase, while the height decreases. The rate of change gradually decreases.

The speed (S) of a free wave in deep water is nearly independent of its height or steepness. For swell, its

Fetch	BEAUFORT NUMBER																											Fetch	
	3			4			5			6			7			8			9			10			11				
	T	H	P	T	H	P	T	H	P	T	H	P	T	H	P	T	H	P	T	H	P	T	H	P	T	H	P		
10	4.4	1.8	2.1	3.7	2.6	2.4	3.2	3.5	2.8	2.7	5.0	3.1	2.5	6.0	3.4	2.3	7.3	3.9	2.0	8.0	4.1	1.9	10.0	4.2	1.8	10.0	5.0	10	
20	7.1	2.0	2.5	6.2	3.2	2.9	5.4	4.9	3.3	4.7	7.0	3.8	4.2	8.6	4.3	3.9	10.0	4.4	3.5	12.0	5.0	3.2	14.0	5.2	3.0	16.0	5.9	20	
30	9.8	2.0	2.8	8.3	3.8	3.3	7.2	5.8	3.7	6.2	8.0	4.2	5.8	10.0	4.6	5.2	12.1	5.0	4.7	15.8	5.5	4.4	18.0	6.0	4.1	19.8	6.3	30	
40	12.0	2.0	3.0	10.3	3.9	3.6	8.9	6.2	4.1	7.8	9.0	4.6	7.1	11.2	4.9	6.5	14.0	5.4	5.8	17.7	5.9	5.4	21.0	6.3	5.1	22.5	6.7	40	
50	14.0	2.0	3.2	12.4	4.0	3.8	11.0	6.5	4.4	9.1	9.8	4.8	8.4	12.2	5.2	7.7	15.7	5.6	6.9	19.8	6.3	6.4	23.0	6.7	6.1	25.0	7.1	50	
60	16.0	2.0	3.5	14.0	4.0	4.0	12.0	6.8	4.6	10.2	10.3	5.1	9.6	13.2	5.5	8.7	17.0	6.0	8.0	21.0	6.5	7.4	25.0	7.0	7.0	27.5	7.5	60	
70	18.0	2.0	3.7	15.8	4.0	4.1	13.5	7.0	4.8	11.9	10.8	5.4	10.5	13.9	5.7	9.9	18.0	6.4	9.0	22.5	6.8	8.3	26.5	7.3	7.8	29.5	7.7	70	
80	20.0	2.0	3.8	17.0	4.0	4.2	15.0	7.2	4.9	13.0	11.0	5.6	12.0	14.5	6.0	11.0	18.9	6.6	10.0	24.0	7.1	9.3	28.0	7.7	8.6	31.5	7.9	80	
90	23.6	2.0	3.9	18.8	4.0	4.3	16.5	7.3	5.1	14.1	11.2	5.8	13.0	15.0	6.3	12.0	20.0	6.7	11.0	25.0	7.2	10.2	30.0	7.9	9.5	34.0	8.2	90	
100	27.1	2.0	4.0	20.0	4.0	4.4	17.5	7.3	5.3	15.1	11.4	6.0	14.0	15.5	6.5	12.8	20.5	6.9	11.9	26.5	7.6	11.0	32.0	8.1	10.3	35.0	8.5	100	
120	31.1	2.0	4.2	22.4	4.1	4.7	20.0	7.8	5.4	17.0	11.7	6.2	15.9	16.0	6.7	14.5	21.5	7.3	13.1	27.5	7.9	12.3	33.5	8.4	11.5	37.5	8.8	120	
140	36.6	2.0	4.5	25.8	4.2	4.9	22.5	7.9	5.8	19.1	11.9	6.4	17.6	16.2	7.0	16.0	22.0	7.6	14.8	29.0	8.3	13.9	35.5	8.8	13.0	40.0	9.2	140	
160	43.2	2.0	4.9	28.4	4.2	5.2	24.3	7.9	6.0	21.1	12.0	6.6	19.5	16.5	7.3	18.0	23.0	8.0	16.4	30.5	8.7	15.1	37.0	9.1	14.5	42.5	9.6	160	
180	50.0	2.0	4.9	30.9	4.3	5.4	27.0	8.0	6.2	23.1	12.1	6.8	21.3	17.0	7.5	19.9	23.5	8.3	18.0	31.5	9.0	16.5	38.5	9.5	16.0	44.5	10.0	180	
200				33.5	4.3	5.6	29.0	8.0	6.4	25.4	12.2	7.1	23.1	17.5	7.7	21.5	23.5	8.5	19.3	32.5	9.2	18.1	40.0	9.8	17.1	46.0	10.3	200	
220				36.5	4.4	5.8	31.1	8.0	6.6	27.2	12.3	7.2	25.0	17.9	8.0	22.9	24.0	8.8	20.9	34.0	9.6	19.1	41.5	10.1	18.2	47.5	10.6	220	
240				39.2	4.4	5.9	33.1	8.0	6.8	29.0	12.4	7.3	26.8	17.9	8.2	24.4	24.5	9.0	22.0	34.5	9.8	20.5	43.0	10.3	19.5	49.0	10.8	240	
260				41.9	4.4	6.0	34.9	8.0	6.9	30.5	12.6	7.5	28.0	18.0	8.4	26.0	25.0	9.2	23.5	34.5	10.0	21.8	44.0	10.6	20.9	50.5	11.1	260	
280				44.5	4.4	6.2	36.8	8.0	7.0	32.4	12.9	7.8	29.5	18.0	8.5	27.7	25.0	9.4	25.0	35.0	10.2	23.0	45.0	10.9	22.0	51.5	11.3	280	
300				47.0	4.4	6.3	38.5	8.0	7.1	34.1	13.1	8.0	31.5	18.0	8.7	29.0	25.0	9.5	26.3	35.0	10.4	24.3	45.0	11.1	23.2	53.0	11.6	300	
320							40.5	8.0	7.2	36.0	13.3	8.2	33.0	18.0	8.9	30.2	25.0	9.6	27.6	35.5	10.6	25.5	45.5	11.2	24.5	54.0	11.8	320	
340							42.4	8.0	7.3	37.6	13.4	8.3	34.2	18.0	9.0	31.6	25.0	9.8	29.0	36.0	10.8	26.7	46.0	11.4	25.5	55.0	12.0	340	
360							44.2	8.0	7.4	38.8	13.4	8.4	35.7	18.1	9.1	33.0	25.0	9.9	30.0	36.5	10.9	27.7	46.5	11.6	26.6	55.0	12.2	360	
380							46.1	8.0	7.5	40.2	13.5	8.5	37.1	18.2	9.3	34.2	25.5	10.0	31.3	37.0	11.1	29.1	47.0	11.8	27.7	55.5	12.4	380	
400							48.0	8.0	7.7	42.2	13.5	8.6	38.8	18.4	9.5	35.6	26.0	10.2	32.5	37.0	11.2	30.2	47.5	12.0	28.9	56.0	12.6	400	
420							50.0	8.0	7.8	43.5	13.6	8.7	40.0	18.7	9.6	36.9	26.5	10.3	33.7	37.5	11.4	31.5	47.5	12.2	29.6	56.5	12.7	420	
440							52.0	8.0	7.9	44.7	13.7	8.8	41.3	18.8	9.7	38.1	27.0	10.4	34.8	37.5	11.5	32.5	48.0	12.3	30.9	57.0	12.9	440	
460							54.0	8.0	8.0	46.2	13.7	8.9	42.8	19.0	9.8	39.5	27.5	10.6	36.0	37.5	11.7	33.5	48.5	12.5	31.8	57.5	13.1	460	
480							56.0	8.0	8.1	47.8	13.7	9.0	44.0	19.0	9.9	41.0	27.5	10.8	37.0	37.5	11.8	34.5	49.0	12.6	32.7	57.5	13.2	480	
500							58.0	8.0	8.2	49.2	13.8	9.1	45.5	19.1	10.1	42.1	27.5	10.9	38.3	38.0	11.9	35.5	49.0	12.7	33.9	58.0	13.4	500	
550										53.0	13.8	9.3	48.5	19.5	10.3	44.9	27.5	11.1	41.0	38.5	12.2	38.2	50.0	13.0	36.5	59.0	13.7	550	
600										56.3	13.8	9.5	51.8	19.7	10.5	47.7	27.5	11.3	43.6	39.0	12.5	40.3	50.0	13.3	38.7	60.0	14.0	600	
650													55.0	19.8	10.7	50.3	27.5	11.6	46.4	39.5	12.8	43.0	50.0	13.7	41.0	60.0	14.2	650	
700													58.5	19.8	11.0	53.2	27.5	11.8	49.0	40.0	13.1	45.4	50.5	14.0	43.5	60.5	14.5	700	
750																56.2	27.5	12.1	51.0	40.0	13.3	48.0	51.0	14.2	45.8	61.0	14.8	750	
800																59.2	27.5	12.3		53.8	40.0	13.5	50.6	51.5	14.5	47.8	61.5	15.0	800
850																			56.2	40.0	13.8	52.5	52.0	14.6	50.0	62.0	15.2	850	
900																			58.2	40.0	14.0	54.6	52.0	14.9	52.0	62.5	15.5	900	
950																						57.2	52.0	15.1	54.0	63.0	15.7	950	
1000																						59.3	52.0	15.3	56.3	63.0	16.0	1000	

Table 3702b. Minimum Time (T) in hours that wind must blow to form waves of H significant height (in feet) and P period (in seconds). Fetch in nautical miles.

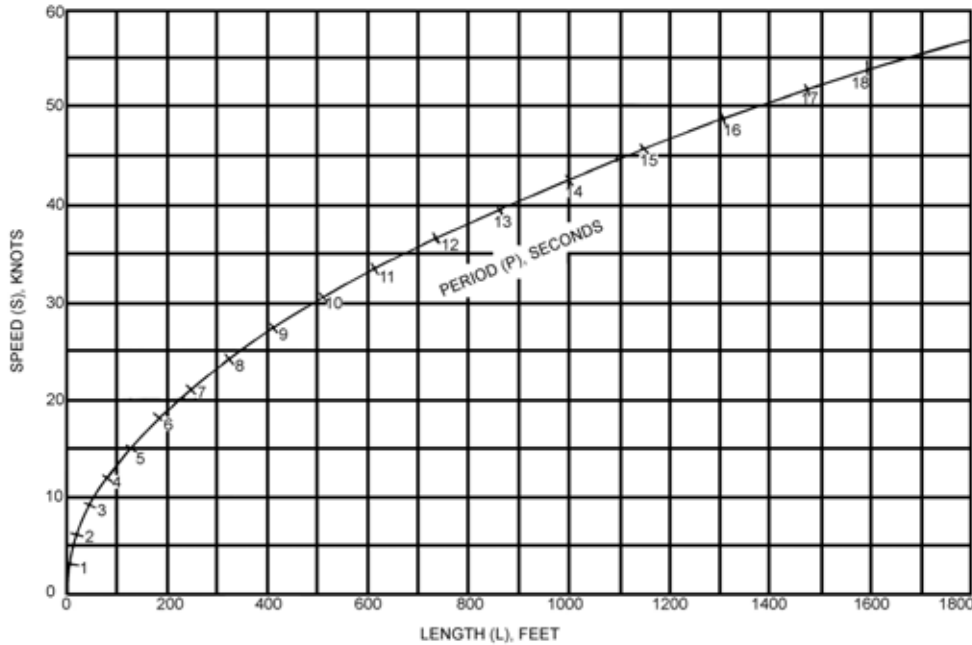

Figure 3702c. Relationship between speed, length, and period of waves in deep water, based upon the theoretical relationship between period and length.

relationship in knots to the period (P) in seconds is given by the formula:

$$S = 3.03P.$$

The relationship for sea is not known.

The theoretical relationship between speed, wavelength, and period is shown in Figure 3702c. As waves continue on beyond the generating area, the period, wavelength, and speed remain the same. Because the waves of each period have different speeds they tend to sort themselves by periods as they move away from the generating area. The longer period waves move at a greater speed and move ahead. At great enough distances from a storm area the waves will have sorted themselves into sets based on period.

All waves are attenuated as they propagate but the short period waves attenuate faster, so that far from a storm only the longer waves remain.

The time needed for a wave system to travel a given distance is double that which would be indicated by the speed of individual waves. This is because each leading wave in succession gradually disappears and transfers its energy to following wave. The process occurs such that the whole wave system advances at a speed which is just half that of each individual wave. This process can easily be seen in the bow wave of a vessel. The speed at which the wave system advances is called **group velocity**.

Because of the existence of many independent wave systems at the same time, the sea surface acquires a complex and irregular pattern. Since the longer waves

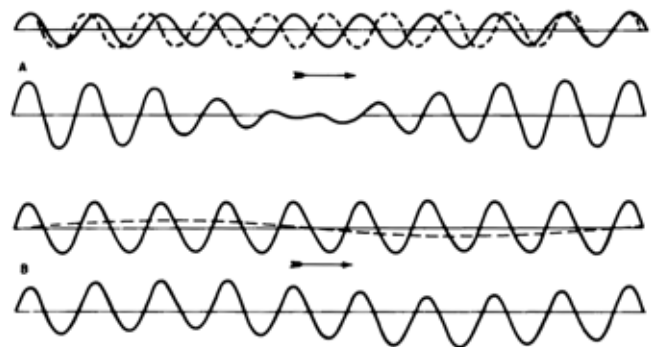

Figure 3702d. Interference. The upper part of A shows two waves of equal height and nearly equal length traveling in the same direction. The lower part of A shows the resulting wave pattern. In B similar information is shown for short waves and long swell.

overrun the shorter ones, the resulting interference adds to the complexity of the pattern. The process of interference, illustrated in Figure 3702d, is duplicated many times in the sea; it is the principal reason that successive waves are not of the same height. The irregularity of the surface may be further accentuated by the presence of wave systems crossing at an angle to each other, producing peak-like rises.

In reporting average wave heights, the mariner has a tendency to neglect the lower ones. It has been found that the reported value is about the average for the highest one-third. This is sometimes called the “significant” wave

height. The approximate relationship between this height and others, is as follows:

Wave	Relative height
Average	0.64
Significant	1.00
Highest 10 percent	1.29
Highest	1.87

3703. Path of Water Particles in a Wave

As shown in Figure 3703, a particle of water on the surface of the ocean follows a somewhat circular orbit as a wave passes, but moves very little in the direction of motion of the wave. The common wave producing this action is called an **oscillatory wave**. As the crest passes, the particle moves forward, giving the water the appearance of moving with the wave. As the trough passes, the motion is in the opposite direction. The radius of the circular orbit decreases with depth, approaching zero at a depth equal to about half the wavelength. In shallower water the orbits become more elliptical, and in very shallow water the vertical motion disappears almost completely.

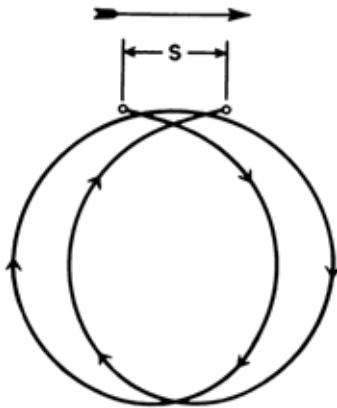

Figure 3703. Orbital motion and displacement, S , of a particle on the surface of deep water during two wave periods.

Since the speed is greater at the top of the orbit than at the bottom, the particle is not at exactly its original point following passage of a wave, but has moved slightly in the wave's direction of motion. However, since this advance is small in relation to the vertical displacement, a floating object is raised and lowered by passage of a wave, but moved little from its original position. If this were not so, a slow moving vessel might experience considerable difficulty in making way against a **wave train**, a series of waves moving in the same direction. In Figure 3703 the forward displacement is greatly exaggerated.

3704. Effects of Current and Ice on Waves

A following current increases wavelengths and

decreases wave heights. An opposing current has the opposite effect, decreasing the length and increasing the height. This effect can be dangerous in certain areas of the world where a stream current opposes waves generated by severe weather. An example of this effect is off the coast of South Africa, where the Agulhas current is often opposed by westerly storms, creating steep, dangerous seas. A strong opposing current may cause the waves to break, as in the case of **overfalls** in tidal currents. The extent of wave alteration is dependent upon the ratio of the still-water wave speed to the speed of the current.

Moderate ocean currents running at oblique angles to wave directions appear to have little effect, but strong tidal currents perpendicular to a system of waves have been observed to completely destroy them in a short period of time.

When ice crystals form in seawater, internal friction is greatly increased. This results in smoothing of the sea surface. The effect of pack ice is even more pronounced. A vessel following a lead through such ice may be in smooth water even when a gale is blowing and heavy seas are beating against the outer edge of the pack. Hail or torrential rain is also effective in flattening the sea, even in a high wind.

3705. Waves and Shallow Water

When a wave encounters shallow water, the movement of the water is restricted by the bottom, resulting in reduced wave speed. In deep water wave speed is a function of period. In shallow water, the wave speed becomes a function of depth. The shallower the water, the slower the wave speed. As the wave speed slows, the period remains the same, so the wavelength becomes shorter. Since the energy in the waves remains the same, the shortening of wavelengths results in increased heights. This process is called **shoaling**. If the wave approaches a shallow area at an angle, each part is slowed successively as the depth decreases. This causes a change in direction of motion, or **refraction**, the wave tending to change direction parallel to the depth curves. The effect is similar to the refraction of light and other forms of radiant energy.

As each wave slows, the next wave behind it, in deeper water, tends to catch up. As the wavelength decreases, the height generally becomes greater. The lower part of a wave, being nearest the bottom, is slowed more than the top. This may cause the wave to become unstable, the faster-moving top falling forward or breaking. Such a wave is called a **breaker**, and a series of breakers is **surf**.

Swell passing over a shoal but not breaking undergoes a decrease in wavelength and speed, and an increase in height, which may be sudden and dramatic, depending on the steepness of the seafloor's slope. This **ground swell** may cause heavy rolling if it is on the beam and its period is the same as the period of roll of a vessel, even though the sea may appear relatively calm. It may also cause a **rage**

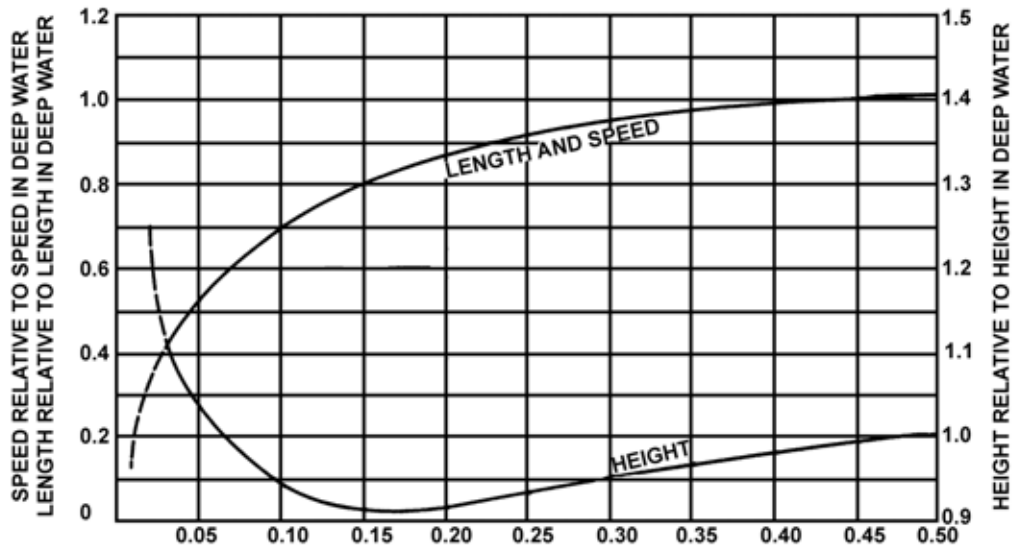

Figure 3705. Alteration of the characteristics of waves crossing a shoal.

sea, when the swell waves encounter water shoal enough to make them break. Rage seas are dangerous to small craft, particularly approaching from seaward, as the vessel can be overwhelmed by enormous breakers in perfectly calm weather. The swell waves, of course, may have been generated hundreds of miles away. In the open ocean they are almost unnoticed due to their very long period and wavelength. Figure 3705 illustrates the approximate alteration of the characteristics of waves as they cross a shoal.

3706. Energy of Waves

The potential energy of a wave is related to the vertical distance of each particle from its still-water position. Therefore potential energy moves with the wave. In contrast, the kinetic energy of a wave is related to the speed of the particles, distributed evenly along the entire wave.

The amount of kinetic energy in a wave is tremendous. A 4-foot, 10-second wave striking a coast expends more than 35,000 horsepower per mile of beach. For each 56 miles of coast, the energy expended equals the power generated at the Hoover Dam. An increase in temperature of the water in the relatively narrow surf zone in which this energy is expended would seem to be indicated, but no pronounced increase has been measured. Apparently, any heat that may be generated is dissipated to the deeper water beyond the surf zone.

3707. Wave Measurement Aboard Ship

With suitable equipment and adequate training, reliable measurements of the height, length, period, and speed of waves can be made. However, the mariner's estimates of height and length often contain relatively large errors. There is a tendency to underestimate the heights of

low waves and overestimate the heights of high ones. There are numerous accounts of waves 75 to 80 feet high, or even higher, although waves more than 55 feet high are very rare. Wavelength is usually underestimated. The motions of the vessel from which measurements are made contribute to such errors.

Height. Measurement of wave height is particularly difficult. A microbarograph can be used if the wave is long enough or the vessel small enough to permit the vessel to ride from crest to trough. If the waves are approaching from dead ahead or dead astern, this requires a wavelength at least twice the length of the vessel. For most accurate results the instrument should be placed at the center of roll and pitch, to minimize the effects of these motions. Wave height can often be estimated with reasonable accuracy by comparing it with freeboard of the vessel. This is less accurate as wave height and vessel motion increase. If a point of observation can be found at which the top of a wave is in line with the horizon when the observer is in the trough, the wave height is equal to height of eye. However, if the vessel is rolling or pitching, this height at the moment of observation may be difficult to determine. The highest wave ever reliably reported was 112 feet observed from the USS Ramapo in 1933. On September 15, 2004 the eye of Hurricane Ivan passed over a series of Naval Research Laboratory (NRL) ocean floor sensors in the Gulf of Mexico. The underwater sensors recorded a wave height of 91 feet.

Length. The dimensions of the vessel can be used to determine wavelength. Errors are introduced by perspective and disturbance of the wave pattern by the vessel. These errors are minimized if observations are made from maximum height. Best results are obtained if the sea is from dead ahead or dead astern.

Period. If allowance is made for the motion of the

vessel, wave period can be determined by measuring the interval between passages of wave crests past the observer. The relative motion of the vessel can be eliminated by timing the passage of successive wave crests past a patch of foam or a floating object at some distance from the vessel. Accuracy of results can be improved by averaging several observations.

Speed. Speed can be determined by timing the passage of the wave between measured points along the side of the ship, if corrections are applied for the direction of travel for the wave and the speed of the ship.

The length, period, and speed of waves are interrelated by the relationships indicated previously. There is no definite mathematical relationship between wave height and length, period, or speed.

3708. Tsunamis

A **Tsunami** is an ocean wave produced by sudden, large-scale motion of a portion of the ocean floor or the shore, such as a volcanic eruption, earthquake (sometimes called seaquake if it occurs at sea), or landslide. If they are caused by a submarine earthquake, they are usually called **seismic sea waves**. The point directly above the disturbance, at which the waves originate, is called the **epicenter**. Either a tsunami or a storm tide that overflows the land is popularly called a **tidal wave**, although it bears no relation to the tide.

If a volcanic eruption occurs below the surface of the sea, the escaping gases cause a quantity of water to be pushed upward in the shape of a dome. The same effect is caused by the sudden rising of a portion of the bottom. As this water settles back, it creates a wave which travels at high speed across the surface of the ocean.

Tsunamis are a series of waves. Near the epicenter, the first wave may be the highest. At greater distances, the highest wave usually occurs later in the series, commonly between the third and the eighth wave. Following the maximum, they again become smaller, but the tsunami may be detectable for several days.

In deep water the wave height of a tsunami is probably never greater than 2 or 3 feet. Since the wavelength is usually considerably more than 100 miles, the wave is not conspicuous at sea. In the Pacific, where most tsunamis occur, the wave period varies between about 15 and 60 minutes and the speed in deep water is more than 400 knots. The approximate speed can be computed by the formula:

$$S = 0.6\sqrt{gd} = 3.4\sqrt{d}$$

where S is the speed in knots, g is the acceleration due to gravity (32.2 feet per second), and d is the depth of water in feet. This formula is applicable to any wave in water having a depth of less than half the wavelength. For most ocean waves it applies only in shallow water, because of the relatively short wavelength.

When a tsunami enters shoal water, it undergoes the

same changes as other waves. The formula indicates that speed is proportional to depth of water. Because of the great speed of a tsunami when it is in relatively deep water, the slowing is relatively much greater than that of an ordinary wave crested by wind. Therefore, the increase in height is also much greater. The size of the wave depends upon the nature and intensity of the disturbance. The height and destructiveness of the wave arriving at any place depends upon its distance from the epicenter, topography of the ocean floor, and the coastline. The angle at which the wave arrives, the shape of the coastline, and the topography along the coast and offshore, all have an effect. The position of the shore is also a factor, as it may be sheltered by intervening land, or be in a position where waves have a tendency to converge, either because of refraction or reflection, or both.

Tsunamis of 50 feet in height or higher have reached the shore, inflicting widespread damage. On December 26, 2004, a magnitude 9.3 earthquake off the northwest coast of Sumatra triggered a devastating tsunami. The waves, which reached 80 feet in some locations, killed nearly 300,000 people across Indonesia, Thailand, and Sri Lanka. After a particularly devastating tsunami struck Hawaii in 1946, a tsunami warning system was set up in the Pacific. This system monitors seismic disturbances throughout the Pacific basin and predicts times and heights of tsunamis. Warnings are immediately sent out if a disturbance is detected. For more information on tsunamis see the Pacific Marine Environmental Laboratory/NOAA Center for Tsunami Research website (see Figure 3708).



Figure 3708. NOAA Center for Tsunami Research.
<https://nctr.pmel.noaa.gov/>

In addition to seismic sea waves, earthquakes below the surface of the sea may produce a longitudinal pressure wave that travels upward at the speed of sound. When a ship encounters such a wave, it is felt as a sudden shock which may be so severe that the crew thinks the vessel has struck bottom.

3709. Storm Tides

In relatively tideless seas like the Baltic and Mediterranean, winds cause the chief fluctuations in sea level. Elsewhere, the astronomical tide usually masks these variations. However, under exceptional conditions, either severe extra-tropical storms or tropical cyclones can produce changes in sea level that exceed the normal range of

tide. Low sea level is of little concern except to coastal shipping, but a rise above ordinary high-water mark, particularly when it is accompanied by high waves, can result in a catastrophe.

Although, like tsunamis, these storm tides or storm surges are popularly called tidal waves, they are not associated with the tide. They consist of a single wave crest and hence have no period or wavelength.

Three effects in a storm induce a rise in sea level. The first is wind stress on the sea surface, which results in a piling-up of water (sometimes called “wind set-up”). The second effect is the convergence of wind-driven currents, which elevates the sea surface along the convergence line. In shallow water, bottom friction and the effects of local topography cause this elevation to persist and may even intensify it. The low atmospheric pressure that accompanies severe storms causes the third effect, which is sometimes referred to as the “inverted barometer” as the sea surface rises into the low pressure area. An inch of mercury is equivalent to about 13.6 inches of water, and the adjustment of the sea surface to the reduced pressure can amount to several feet at equilibrium.

All three of these causes act independently and if they happen to occur simultaneously, their effects are additive. In addition, the wave can be intensified or amplified by the effects of local topography. Storm tides may reach heights of 20 feet or more and it is estimated that they cause three-fourths of the deaths attributed to hurricanes.

3710. Standing Waves and Seiches

Previous articles in this chapter have dealt with progres-

sive waves which appear to move regularly with time. When two systems of progressive waves having the same period travel in opposite directions across the same area, a series of **standing waves** may form. These appear to remain stationary. A video of this phenomenon is available through the link provided in Figure 3710a.



Figure 3710a. Standing wave video link;
https://www.youtube.com/watch?v=X8qZ06g_X5Q

Another type of standing wave, called a **seiche**, sometimes occurs in a confined body of water. It is a long wave, usually having its crest at one end of the confined space and its trough at the other. Its period may be anything from a few minutes to an hour or more, but somewhat less than the tidal period. Seiches are usually attributed to strong winds or sudden changes in atmospheric pressure that push water from one end of a body of water to the other. When the wind stops, the water rebounds to the other side of the enclosed area. See Figure 3710b for a graphical depiction of this phenomenon.

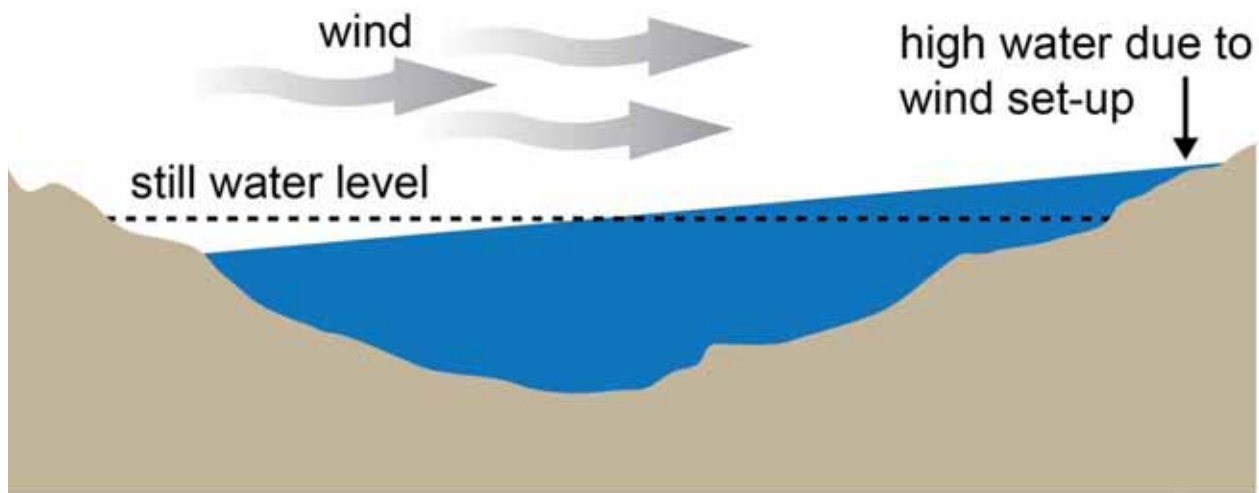

Wind setup is a local rise in water level caused by wind.

Figure 3710b. How seiches form.

Lake Erie is known for seiches, especially when strong winds blow from southwest to northeast. In 1844, a 22 foot seiche breached a 14-foot high sea wall killing 78 people

and damming the ice to the extent that Niagara Falls temporarily stopped flowing.

3711. Tide-Generated Waves

There are, in general, two regions of high tide separated by two regions of low tide and these regions move progressively westward around the Earth as the moon revolves in its orbit. The high tides are the crests of these tide waves and the low tides are the troughs. The wave is not noticeable at sea, but becomes apparent along the coasts, particularly in funnel-shaped estuaries. In certain river mouths, or estuaries of particular configuration, the incoming wave of high water overtakes the preceding low tide, resulting in a steep, breaking wave which progresses upstream in a surge called a **bore**.

3712. Internal Waves

Thus far, the discussion has been confined to waves on the surface of the sea, the boundary between air and water. **Internal waves**, or boundary waves, are created below the surface, at the boundaries between water strata of different densities. The density differences between adjacent water strata in the sea are considerably less than that between sea and air. Consequently, internal waves are much more easily formed than surface waves and they are often much larger. The maximum height of wind waves on the surface is about 60 feet, but internal wave heights as great as 300 feet have been encountered.

Internal waves are detected by a number of observations of the vertical temperature distribution, using recording devices such as the bathythermograph. They have periods as short as a few minutes and as long as 12 or 24 hours, these greater periods being associated with the tides.

A slow-moving ship, operating in a freshwater layer having a depth approximating the draft of the vessel, may produce short-period internal waves. This may occur off rivers emptying into the sea, or in polar regions in the vicinity of melting ice. Under suitable conditions, the normal propulsion energy of the ship is expended in generating and maintaining these internal waves and the ship appears to “stick” in the water, becoming sluggish and making little headway. The phenomenon, known as **dead water**, disappears when speed is increased by a few knots.

The full significance of internal waves has not yet been determined, but it is known that they may cause submarines to rise and fall like a ship at the surface and they may also affect sound transmission in the sea.

3713. Waves and Ships

The effects of waves on a ship vary considerably with the type of ship, its course and speed, and the condition of the sea. A short vessel has a tendency to ride up one side of a wave and

down the other side, while a larger vessel may tend to ride through the waves on an even keel. If the waves are of such length that the bow and stern of a vessel are alternately riding in successive crests and troughs, the vessel is subject to heavy sagging and hogging stresses, and under extreme conditions may break in two. A change of heading may reduce the danger. Because of the danger from sagging and hogging, a small vessel is sometimes better able to ride out a storm than a large one.

If successive waves strike the side of a vessel at the same phase of successive rolls, relatively small waves can cause heavy rolling. The same effect, if applied to the bow or stern in time with the natural period of pitch, can cause heavy pitching. A change of either heading or speed can quickly reduce the effect.

A wave having a length twice that of a ship places that ship in danger of falling off into the trough of the sea, particularly if it is a slow-moving vessel. The effect is especially pronounced if the sea is broad on the bow or broad on the quarter. An increase in speed reduces the hazard.

For more detailed information on **avoiding dangerous situations in adverse weather and sea conditions**, see the International Maritime Organization (IMO) Maritime Safety Committee Circular MSC.1/Circ. 1228. This circular is available for free download to public users who register for an IMODOCS account (see Figure 3713). **Circular 1228** provides ship masters with general and cautionary information, including sections on dangerous phenomenon and operational guidance, which collectively may form a basis for decision making.



Figure 3713. IMODOCS registration.
<https://webaccounts.imo.org/Common/PublicRegistration.aspx>

3714. Using Oil to Calm Breaking Waves

Historically oil was used to calm breaking waves and was useful to vessels when lowering or hoisting boats in rough weather. Its effect was greatest in deep water, where a small quantity sufficed if the oil was made to spread to windward of the vessel. Oil increases the surface tension of the water, lessening the tendency for waves to break.

BREAKERS AND SURF

3715. Refraction

As explained previously, waves are slowed in shallow water, causing refraction if the waves approach the beach at an angle. Along a perfectly straight beach, with uniform shoaling, the wave fronts tend to become parallel to the shore. Any irregularities in the coastline or bottom contours, however, affect the refraction, causing irregularities. In the case of a ridge perpendicular to the beach, for instance, the shoaling is more rapid, causing greater refraction towards the ridge. The waves tend to align themselves with the bottom contours. Waves on both sides of the ridge have a component of motion toward the ridge. This convergence of wave energy toward the ridge causes an increase in wave or breaker height. A submarine canyon or valley perpendicular to the beach, on the other hand, produces divergence, with a

decrease in wave or breaker height. These effects are illustrated in Figure 3715. Bends in the coast line have a similar effect, convergence occurring at a point, and divergence if the coast is concave to the sea. Points act as focal areas for wave energy and experience large breakers. Concave bays have small breakers because the energy is spread out as the waves approach the beach.

Under suitable conditions, currents also cause refraction. This is of particular importance at entrances of tidal estuaries. When waves encounter a current running in the opposite direction, they become higher and shorter. This results in a choppy sea, often with breakers. When waves move in the same direction as current, they decrease in height, and become longer. Refraction occurs when waves encounter a current at an angle.

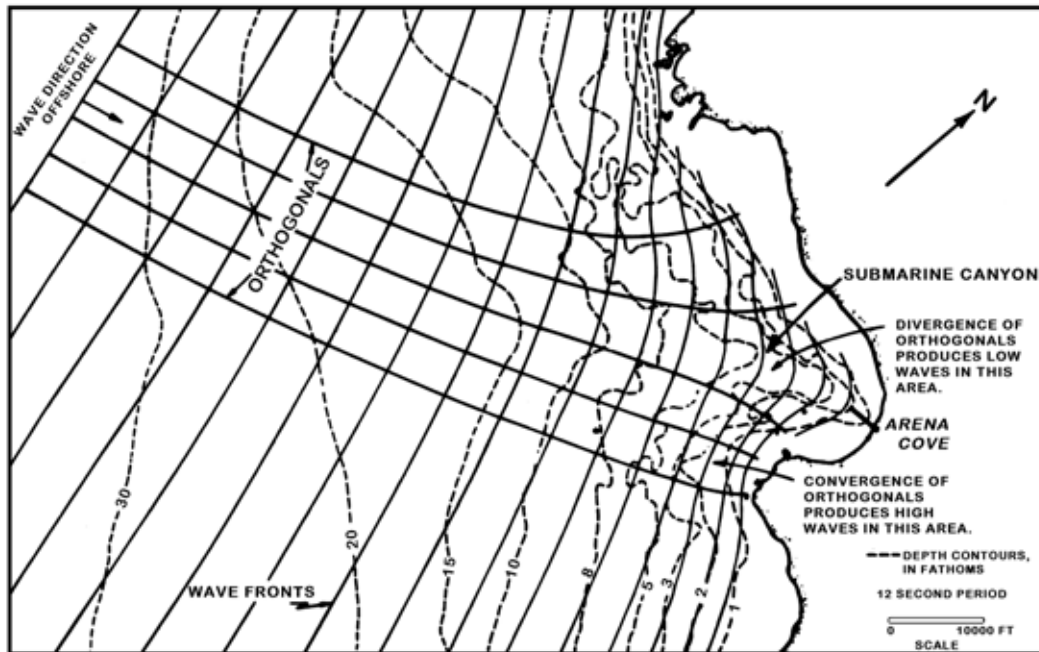

Figure 3715. The effect of bottom topography in causing wave convergence and wave divergence.
 Courtesy of Robert L. Wiegell, Council on Wave Research, University of California.

3716. Classes Of Breakers

In deep water, swell generally moves across the surface as somewhat regular, smooth undulations. When shoal water is reached, the wave period remains the same, but the speed decreases. The amount of decrease is negligible until the depth of water becomes about one-half the wavelength, when the waves begin to “feel” bottom. There is a slight decrease in wave height, followed by a rapid increase, if the waves are traveling perpendicular to a straight coast with a uniformly sloping bottom. As the waves become higher and shorter, they also become steeper, and the crest narrows. When the speed of the crest becomes greater than that of the

wave, the front face of the wave becomes steeper than the rear face. This process continues at an accelerating rate as the depth of water decreases. If the wave becomes too unstable, it topples forward to form a breaker.

There are three general classes of breakers. A **spilling breaker** breaks gradually over a considerable distance. A **plunging breaker** tends to curl over and break with a single crash. A **surging breaker** peaks up, but surges up the beach without spilling or plunging. It is classed as a breaker even though it does not actually break. The type of breaker which forms is determined by the steepness of the beach and the steepness of the wave before it reaches shallow water, as illustrated in Figure 3716.



Spilling Breaker

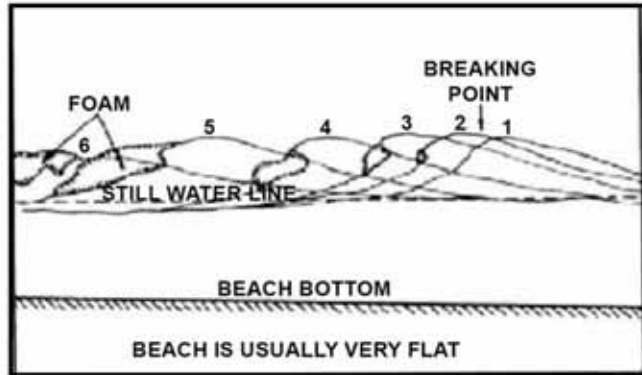

Sketch showing the general character of spilling breakers



Plunging Breaker

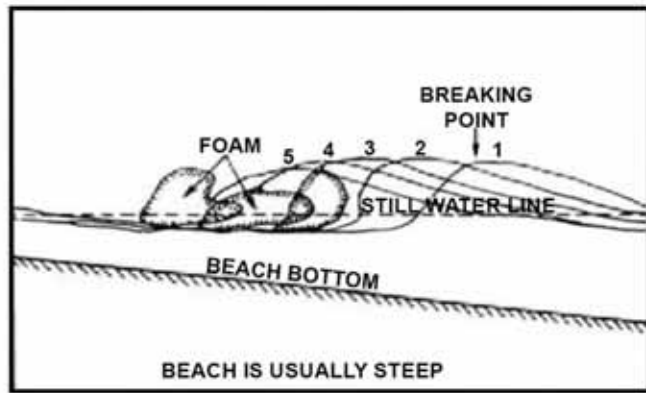

Sketch showing the general character of Plunging breakers



Surging Breaker

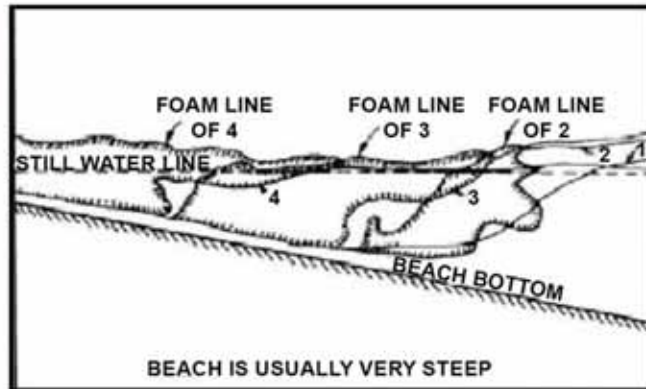

Sketch showing the general character of surging breakers

Figure 3716. The three types of breakers. Graphics courtesy of Robert L. Wiegell.

Long waves break in deeper water, and have a greater breaker height. A steep beach also increases breaker height. The height of breakers is less if the waves approach the beach at an acute angle. With a steeper beach slope there is greater tendency of the breakers to plunge or surge. Following the *uprush* of water onto a beach after the breaking of a wave, the seaward *backrush* occurs. The returning water is called **backwash**. It tends to further slow

the bottom of a wave, thus increasing its tendency to break. This effect is greater as either the speed or depth of the backwash increases. The still water depth at the point of breaking is approximately 1.3 times the average breaker height.

Surf varies with both position along the beach and time. A change in position often means a change in bottom contour, with the refraction effects discussed before. At the

same point, the height and period of waves vary considerably from wave to wave. A group of high waves is usually followed by several lower ones. Therefore, passage through surf can usually be made most easily immediately following a series of higher waves.

Since surf conditions are directly related to height of the waves approaching a beach and to the configuration of the bottom, the state of the surf at any time can be predicted if one has the necessary information and knowledge of the principles involved. Height of the sea and swell can be predicted from wind data and information on bottom configuration can sometimes be obtained from the largest scale nautical chart. In addition, the area of lightest surf along a beach can be predicted if details of the bottom configuration are available. Surf predictions may, however, be significantly in error due to the presence of swell from unknown storms hundreds of miles away.

3717. Currents in the Surf Zone

In and adjacent to the surf zone, currents are generated by waves approaching the bottom contours at an angle, and by irregularities in the bottom.

Waves approaching at an angle produce a **longshore current** parallel to the beach, inside of the surf zone. Longshore currents are most common along straight beaches. Their speeds increase with increasing breaker height, decreasing wave period, increasing angle of breaker line with the beach, and increasing beach slope. Speed seldom exceeds 1 knot, but sustained speeds as high as 3 knots have been recorded. Longshore currents are usually constant in direction. They increase the danger of landing craft broaching to.

Where the bottom is sandy a good distance offshore, one or more **sand bars** typically form. The innermost bar will break in even small waves, and will isolate the longshore current. The second bar, if one forms, will break only in heavier weather, and the third, if present, only in storms. It is possible to move parallel to the coast in small craft in relatively deep water in the area between these bars, between the lines of breakers.

3718. Rip Currents

As explained previously, wave fronts advancing over nonparallel bottom contours are refracted to cause convergence or divergence of the energy of the waves. Energy concentrations in areas of convergence form barriers to the returning backwash, which is deflected along the beach to areas of less resistance. Backwash accumulates at weak points, and returns seaward in concentrations, forming **rip currents** through the surf. At these points the large volume of returning water has an easily seen retarding effect upon the incoming waves, thus adding to the condition causing the rip current. The waves on one or both sides of the rip, having greater energy and not being retarded by the

concentration of backwash, advance faster and farther up the beach. From here, they move along the beach as feeder currents. At some point of low resistance, the water flows seaward through the surf, forming the neck of the rip current. Outside the breaker line the current widens and slackens, forming the head.

Rip currents may also be caused by irregularities in the beach face. If a beach indentation causes an uprush to advance farther than the average, the backrush is delayed and this in turn retards the next incoming foam line (the front of a wave as it advances shoreward after breaking) at that point. The foam line on each side of the retarded point continues in its advance, however, and tends to fill in the retarded area, producing a rip current. See the National Weather Service - **Rip Current Photos** website for images.



Figure 3718. NWS - Rip Current Photos.
www.ripcurrents.noaa.gov/photos.shtml

Rip currents are dangerous for swimmers, but may provide a clear path to the beach for small craft, as they tend to scour out the bottom and break through any sand bars that have formed. By swimming parallel to the beach, swimmers can extract themselves from the pull of a rip current. Rip currents also change location over time as conditions change.

3719. Beach Sediments

In the surf zone, large amounts of sediment are suspended in the water. When the water's motion decreases, the sediments settle to the bottom. The water motion can be either waves or currents. Promontories or points are rocky because the large breakers scour the points and small sediments are suspended in the water and carried away. Bays tend to have sandy beaches because of the smaller waves.

In the winter when storms create large breakers and surf, the waves erode beaches and carry the particles offshore where offshore sand bars form; sandy beaches tend to be narrower in stormy seasons. In the summer the waves gradually move the sand back to the beaches and the offshore sand bars decrease; then sandy beaches tend to be wider.

Longshore currents move large amounts of sand along the coast. These currents deposit sand on the upcurrent side of a jetty or pier, and erode the beach on the downcurrent side. Groins are sometimes built to impede the longshore flow of sediments and preserve beaches for recreational use. As with jetties, the downcurrent side of each groin will

have the best water for approaching the beach.

CHAPTER 38

WEATHER ELEMENTS

GENERAL DESCRIPTION OF THE ATMOSPHERE

3800. Introduction

Weather is the state of the Earth's atmosphere with respect to temperature, humidity, precipitation, visibility, cloudiness, and other factors. **Climate** refers to the average long-term meteorological conditions of a place or region.

All weather may be traced to the effect of the Sun on the Earth. Most changes in weather involve large-scale horizontal motion of air. Air in motion is called **wind**. This motion is produced by differences in atmospheric pressure, which are attributable both to differences in temperature and the nature of the motion itself.

Weather is of vital importance to the mariner. The wind and state of the sea affect dead reckoning. Reduced visibility limits piloting. The state of the atmosphere affects electronic navigation and radio communication. If the skies are overcast, celestial observations are not available. Under certain conditions, refraction and dip are disturbed. When wind was the primary motive power, knowledge of the areas of favorable winds was of great importance. Modern vessels are still affected considerably by wind and sea.

3801. The Atmosphere

The **atmosphere** is a relatively thin shell of air, water vapor, and suspended particulates surrounding the Earth. Air is a mixture of gases and, like any gas, is elastic and highly compressible. Although extremely light, it has a definite weight which can be measured. A cubic foot of air at standard sea-level temperature and pressure weighs 1.22 ounces, or about $\frac{1}{817}$ th the weight of an equal volume of water. Because of this weight, the atmosphere exerts a pressure upon the surface of the Earth of about 15 pounds per square inch.

As altitude increases, air pressure decreases due to the decreased weight of air above. With less pressure, the density decreases. More than three-fourths of the air is concentrated within a layer averaging about 7 statute miles thick, called the **troposphere**. This is the region of most "weather," as the term is commonly understood.

The top of the troposphere is marked by a thin transition zone called the **tropopause**, immediately above which is the **stratosphere**. Beyond this lie several other layers having distinctive characteristics. The average height of the tropopause ranges from about 5 miles or less at high latitudes to about 10 miles at low latitudes.

The **standard atmosphere** is a conventional vertical structure of the atmosphere characterized by a standard sea-level pressure of 1013.25 hectopascals of mercury (29.92 inches) and a sea-level air temperature of 15° C (59° F). The temperature decreases with height at the **standard lapse rate**, a uniform 2° C (3.6° F) per thousand feet to 11 kilometers (36,089 feet), and above that remains constant at -56.5° C (-69.7° F).

The **jet stream** refers to relatively strong (greater than 60 knots) quasi-horizontal winds, usually concentrated within a restricted layer of the atmosphere. Research has indicated that the jet stream is important in relation to the sequence of weather. There are two commonly known jet streams. The **sub-tropical jet stream (STJ)** occurs in the region of 30°N during the northern hemisphere winter, decreasing in summer. The core of highest winds in the STJ is found at about 12km altitude (40,000 feet) in the region of 70°W, 40°E, and 150°E, although considerable variability is common. The **polar frontal jet stream (PFJ)** is found in middle to upper-middle latitudes and is discontinuous and variable. Maximum jet stream winds have been measured by weather balloons at 291 knots.

3802. General Circulation of the Atmosphere

The heat required to warm the air is supplied originally by the Sun. As radiant energy from the Sun arrives at the Earth, about 29 percent is reflected back into space by the Earth and its atmosphere, 19 percent is absorbed by the atmosphere, and the remaining 52 percent is absorbed by the surface of the Earth. Much of the Earth's absorbed heat is radiated back into space. Earth's radiation is in comparatively long waves relative to the short-wave radiation from the Sun because it emanates from a cooler body. Long-wave radiation, readily absorbed by the water vapor in the air, is primarily responsible for the warmth of the atmosphere near the Earth's surface. Thus, the atmosphere acts much like the glass on the roof of a greenhouse. It allows part of the incoming solar radiation to reach the surface of the Earth but is heated by the terrestrial radiation passing outward. Over the entire Earth and for long periods of time, the total outgoing energy must be equivalent to the incoming energy (minus any converted to another form and retained), or the temperature of the Earth and its atmosphere would steadily increase or decrease. In local areas, or over relatively short periods of time, such a balance is not

required. In fact it does not exist, resulting in changes such as those occurring from one year to another, in different seasons and in different parts of the day.

The more nearly perpendicular the rays of the Sun strike the surface of the Earth, the more heat energy per unit area is received at that place. Physical measurements show that in the tropics, more heat per unit area is received than is radiated away, and that in polar regions, the opposite is true. Unless there were some process to transfer heat from the tropics to polar regions, the tropics would be much warmer than they are, and the polar regions would be much colder. Atmospheric motions bring about the required transfer of heat. The oceans also participate in the process, but to a lesser degree.

If the Earth had a uniform surface and did not rotate on its axis, with the Sun following its normal path across the sky (solar heating increasing with decreasing latitude), a simple circulation would result, as shown in Figure 3802a. However, the surface of the Earth is far from uniform, being covered with an irregular distribution of land and water. Additionally, the Earth rotates about its axis so that the portion heated by the Sun continually changes. In addition, the axis of rotation is tilted so that as the Earth moves along its

orbit about the Sun, seasonal changes occur in the exposure of specific areas to the Sun's rays, resulting in variations in the heat balance of these areas. These factors, coupled with others, result in constantly changing large-scale movements of air. For example, the rotation of the Earth exerts an apparent force, known as **Coriolis force**, which diverts the air from a direct path between high and low pressure areas. The diversion of the air is toward the right in the Northern Hemisphere and toward the left in the Southern Hemisphere. At some distance above the surface of the Earth, the wind tends to blow along lines connecting points of equal pressure called **isobars**. The wind is called a **geostrophic wind** if it blows parallel to the isobars. This normally occurs when the isobars are straight (great circles). However, isobars curve around highs and lows, and the air is not generally able to maintain itself parallel to these. The resulting cross-isobar flow is called a **gradient wind**. Near the surface of the Earth, friction tends to divert the wind from the isobars toward the center of low pressure. At sea, where friction is less than on land, the wind follows the isobars more closely.

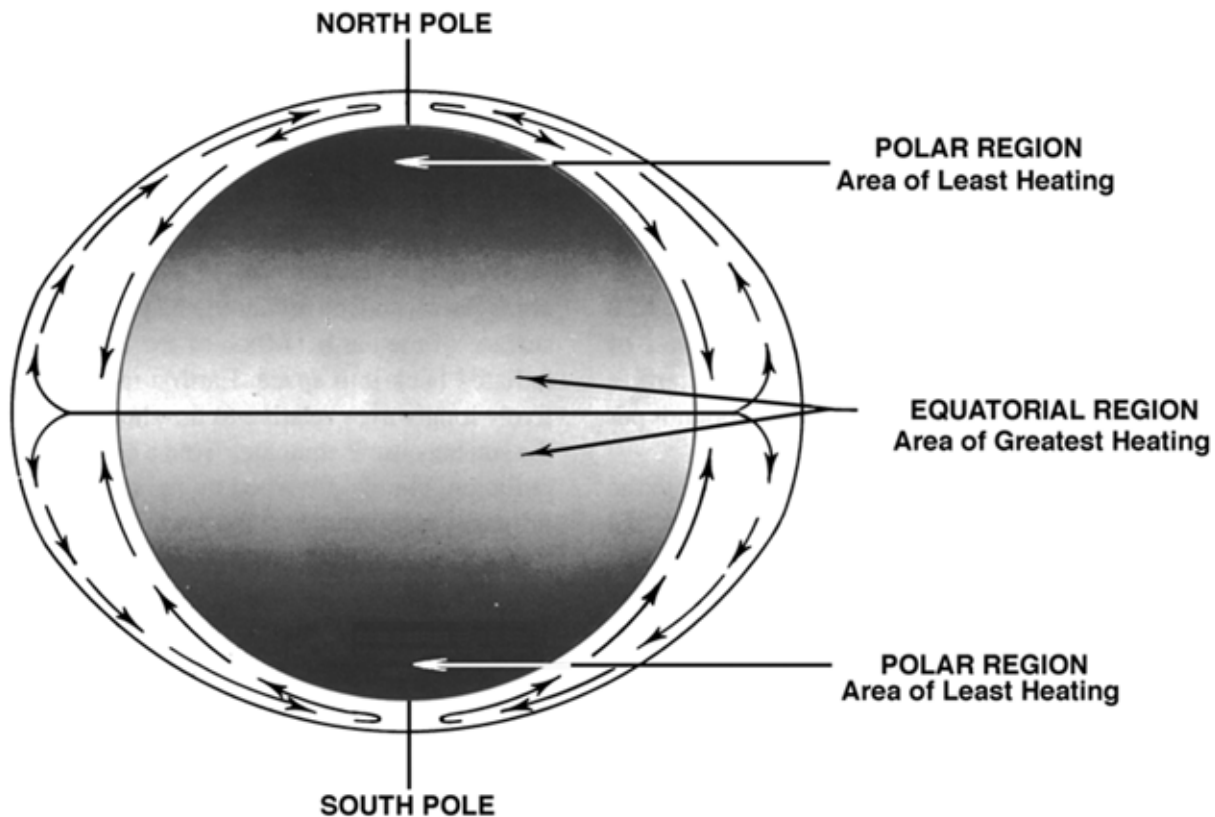

Figure 3802a. Ideal atmospheric circulation for a uniform and non-rotating Earth.

A simplified diagram of the general circulation pattern is shown in Figure 3802b. Figure 3802c and Figure 3802d give a generalized picture of the world's pressure distribu-

tion and wind systems as actually observed.

A change in pressure with horizontal distance is called a **pressure gradient**. It is maximum along a normal (per-

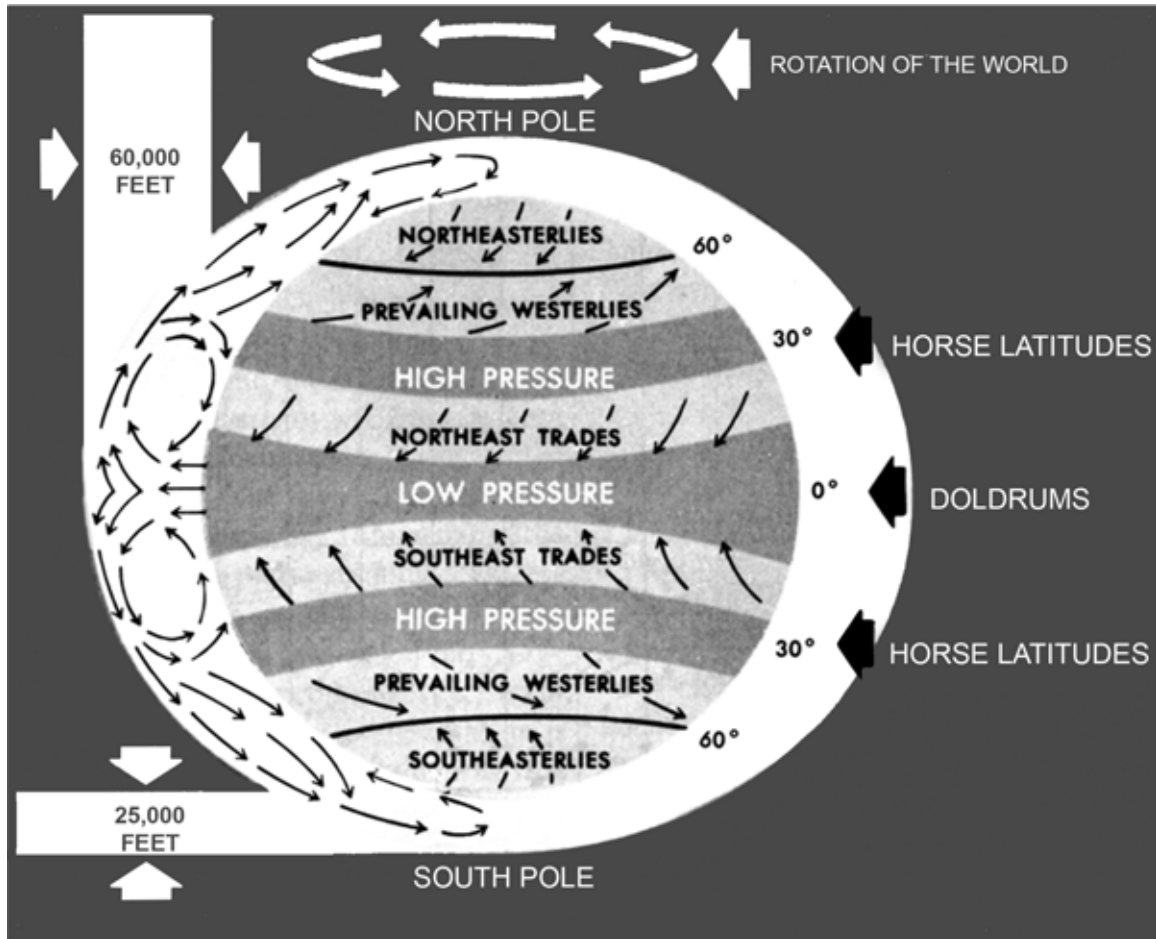

Figure 3802b. Simplified diagram of the general circulation of the atmosphere.

pendicular) to the isobars. A force results which is called **pressure gradient force** and is always directed from high to low pressure. Speed of the wind is approximately propor-

tional to this pressure gradient.

MAJOR WIND PATTERNS

3803. The Doldrums

A belt of low pressure at the Earth's surface near the equator, known as the **doldrums**, occupies a position approximately midway between high pressure belts at about latitude 30° to 35° on each side. Except for significant intradiurnal changes, the atmospheric pressure along the equatorial low is almost uniform. With minimal pressure gradient, wind speeds are light and directions are variable. Hot, sultry days are common. The sky is often overcast, and showers and thunderstorms are relatively frequent. In these atmospherically unstable areas, brief periods of strong wind occur.

The doldrums occupy a thin belt near the equator, the eastern part in both the Atlantic and Pacific being wider than the western part. However, both the position and extent of the belt vary with longitude and season. During all seasons in the Northern Hemisphere, the belt is centered in the eastern

Atlantic and Pacific; however, there are wide excursions of the doldrum regions at longitudes with considerable landmass. On the average, the position is at 5°N, frequently called the **meteorological equator**.

3804. The Trade Winds

The trade winds at the surface blow from the belts of high pressure toward the equatorial belts of low pressure. Because of the rotation of the Earth, the moving air is deflected toward the west. Therefore, the trade winds in the Northern Hemisphere are from the northeast and are called the **northeast trades**, while those in the Southern Hemisphere are from the southeast and are called the **southeast trades**. The trade-wind directions are best defined over eastern ocean areas.

The trade winds are generally considered among the

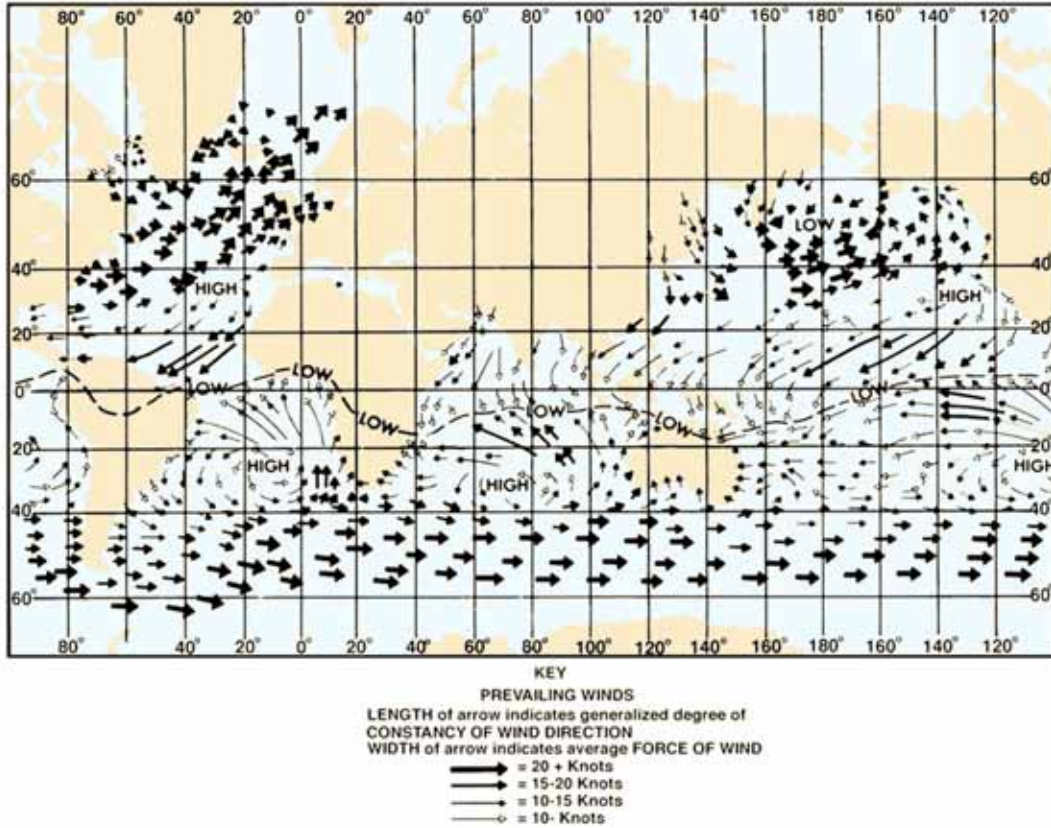

Figure 3802c. Generalized pattern of actual surface winds in January and February.

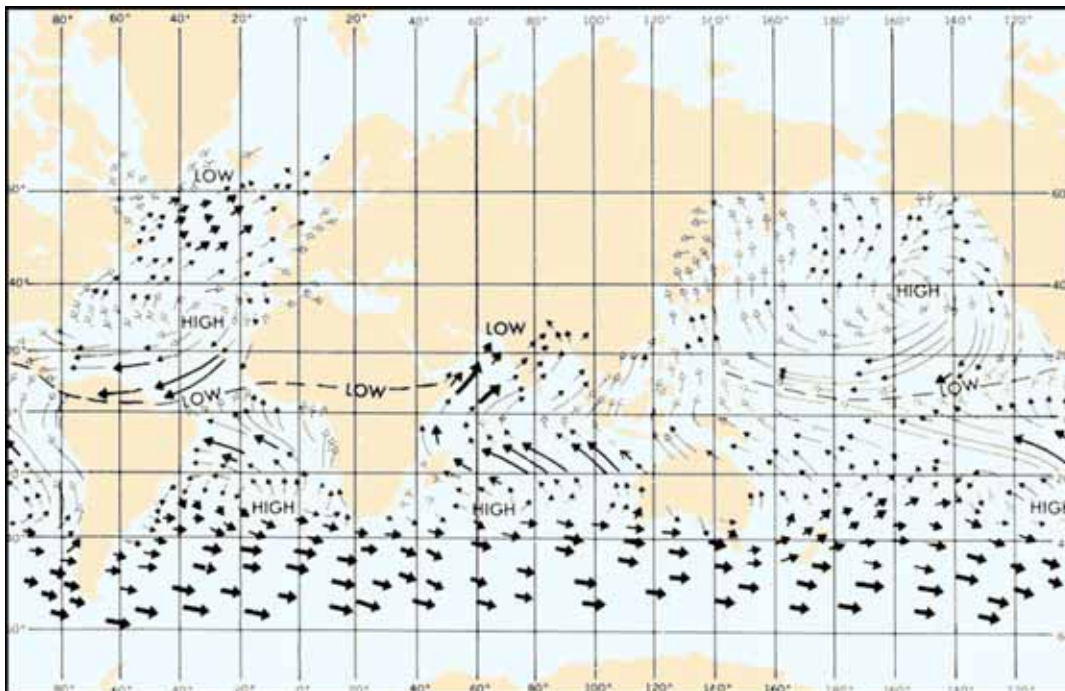

Figure 3802d. Generalized pattern of actual surface winds in July and August. (See key with Figure 3402c).

most constant of winds, blowing for days or even weeks with little change of direction or speed. However, at times

they weaken or shift direction, and there are regions where the general pattern is disrupted. A notable example is found in the island groups of the South Pacific, where the trades are practically nonexistent during January and February. Their best development is attained in the South Atlantic and in the South Indian Ocean. In general, they are stronger during the winter than during the summer season.

In July and August, when the belt of equatorial low pressure moves to a position some distance north of the equator, the southeast trades blow across the equator, into the Northern Hemisphere, where the Earth's rotation diverts them toward the right, causing them to be southerly and southwesterly winds. The "southwest monsoons" of the African and Central American coasts originate partly in these diverted southeast trades.

Cyclones from the middle latitudes rarely enter the regions of the trade winds, although tropical cyclones originate within these areas.

3805. The Horse Latitudes

Along the poleward side of each trade-wind belt and corresponding approximately with the belt of high pressure in each hemisphere, is another region with weak pressure gradients and correspondingly light, variable winds. These are called the **horse latitudes**, apparently so named because becalmed sailing ships threw horses overboard in this region when water supplies ran short. The weather is generally good although low clouds are common. Compared to the doldrums, periods of stagnation in the horse latitudes are less persistent. The difference is due primarily to the rising currents of warm air in the equatorial low, which carries large amounts of moisture. This moisture condenses as the air cools at higher levels, while in the horse latitudes the air is apparently descending and becoming less humid as it is warmed at lower heights.

3806. The Prevailing Westerlies

On the poleward side of the high pressure belt in each hemisphere, the atmospheric pressure again diminishes. The currents of air set in motion along these gradients toward the poles are diverted by the Earth's rotation toward the east, becoming southwesterly winds in the Northern Hemisphere and northwesterly in the Southern Hemisphere. These two wind systems are known as the **prevailing westerlies** of the temperate zones.

In the Northern Hemisphere this relatively simple pattern is distorted considerably by secondary wind circulations, due primarily to the presence of large landmasses. In the North Atlantic, between latitudes 40° and 50°, winds blow from some direction between south and northwest during 74 percent of the time, being somewhat more persistent in winter than in summer. They are stronger in winter, too, averaging about 25 knots (Beaufort 6) as compared with 14 knots (Beaufort 4) in the

summer.

In the Southern Hemisphere the westerlies blow throughout the year with a steadiness approaching that of the trade winds. The speed, though variable, is generally between 17 and 27 knots (Beaufort 5 and 6). Latitudes 40°S to 50°S, where these boisterous winds occur, are called the **roaring forties**. These winds are strongest at about latitude 50°S.

The greater speed and persistence of the westerlies in the Southern Hemisphere are due to the difference in the atmospheric pressure pattern, and its variations, from the Northern Hemisphere. In the comparatively landless Southern Hemisphere, the average yearly atmospheric pressure diminishes much more rapidly on the poleward side of the high pressure belt, and has fewer irregularities due to continental interference, than in the Northern Hemisphere.

3807. Polar Winds

Partly because of the low temperatures near the geographical poles of the Earth, the surface pressure tends to remain higher than in surrounding regions, since cold air is more dense than warm air. Consequently, the winds blow outward from the poles and are deflected westward by the rotation of the Earth, to become **northeasterlies** in the Arctic, and **southeasterlies** in the Antarctic. Where the polar easterlies meet the prevailing westerlies, near 50°N and 50°S on the average, a discontinuity in temperature and wind exists. This discontinuity is called the **polar front**. Here the warmer low-latitude air ascends over the colder polar air creating a zone of cloudiness and precipitation.

In the Arctic, the general circulation is greatly modified by surrounding landmasses. Winds over the Arctic Ocean are somewhat variable, and strong surface winds are rarely encountered.

In the Antarctic, on the other hand, a high central landmass is surrounded by water, a condition which augments, rather than diminishes, the general circulation. A high pressure, although weaker than in the horse latitudes, is stronger than in the Arctic and of great persistence especially in eastern Antarctica. The cold air from the plateau areas moves outward and downward toward the sea and is deflected toward the west by the Earth's rotation. The winds remain strong throughout the year, frequently attaining hurricane force near the base of the mountains. These are some of the strongest surface winds encountered anywhere in the world, with the possible exception of those in well-developed tropical cyclones.

3808. Modifications of the General Circulation

The general circulation of the atmosphere is greatly modified by various conditions. The high pressure in the

horse latitudes is not uniformly distributed around the belts, but tends to be accentuated at several points, as shown in Figure 3802c and Figure 3802d. These semi-permanent highs remain at about the same places with great persistence.

Semi-permanent lows also occur in various places, the most prominent ones being west of Iceland and over the Aleutians (winter only) in the Northern Hemisphere, and in the Ross Sea and Weddell Sea in the Antarctic areas. The regions occupied by these semi-permanent lows are sometimes called the graveyards of the lows, since many lows move directly into these areas and lose their identity as they merge with and reinforce the semi-permanent lows. The low pressure in these areas is maintained largely by the migratory lows which stall there, with topography also important, especially in Antarctica.

Another modifying influence is land, which undergoes greater temperature changes than does the sea. During the summer, a continent is warmer than its adjacent oceans. Therefore, low pressures tend to prevail over the land. If a climatological belt of high pressure encounters a continent, its pattern is distorted or interrupted, whereas a belt of low pressure is intensified over the same area. In winter, the opposite effect takes place, belts of high pressure being intensified over land and those of low pressure being weakened.

The most striking example of a wind system produced by the alternate heating and cooling of a landmass is the **monsoon** (seasonal wind) of the South China Sea and Indian Ocean. A portion of this effect is shown in Figure 3808. In the summer, low pressure prevails over the warm continent of Asia, and relatively higher pressure prevails over the adjacent, cooler sea. Between these two systems the wind blows in a nearly steady direction. The lower portion of the pattern is in the Southern Hemisphere, extending to about 10° south latitude. Here the rotation of the Earth causes a deflection to the left, resulting in southeasterly winds. As they cross the equator, the deflection is in the opposite direction, causing them to curve toward the right, becoming southwesterly winds. In the winter, the positions of high and low pressure areas are interchanged, and the direction of flow is reversed.

In the South China Sea, the summer monsoon blows from the southwest, usually from May to September. The strong winds are accompanied by heavy squalls and thunderstorms, the rainfall being much heavier than during the winter monsoon. As the season advances, squalls and rain become less frequent. In some places the wind becomes a light breeze which is unsteady in direction, or stops altogether, while in other places it continues almost

Abroholos

A squall frequent from May through August between Cabo de Sao Tome and Cabo Frio on the coast of Brazil.

Bali wind

A strong east wind at the eastern end of Java.

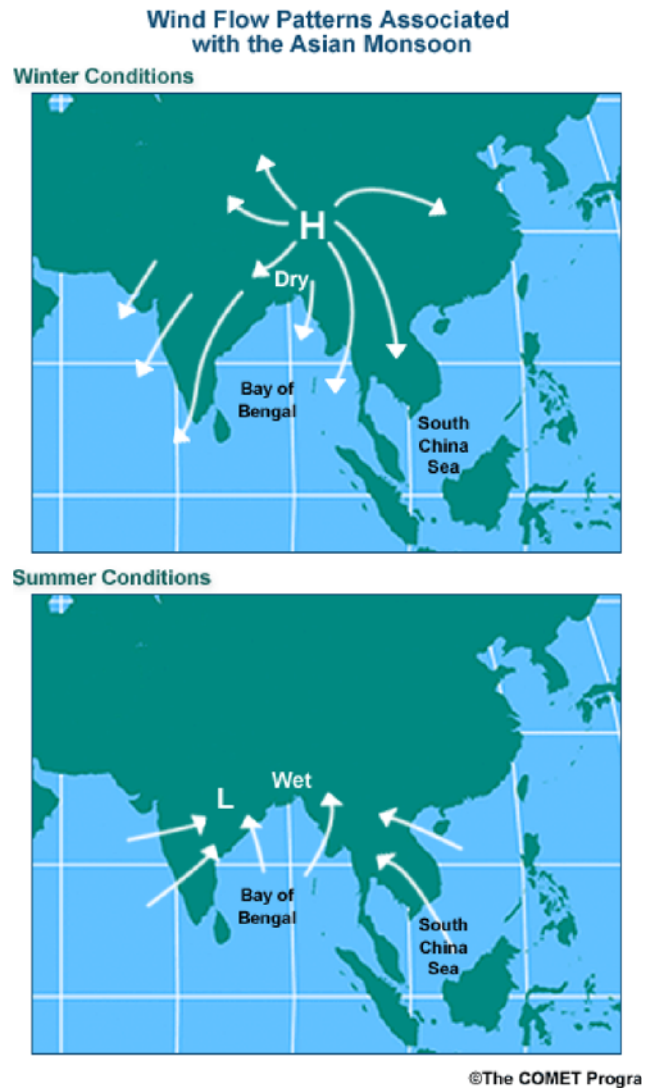

Figure 3808. The winter and summer monsoon. Used with permission of UCAR/COMET Program.

undiminished, with changes in direction or calms being infrequent. The winter monsoon blows from the northeast, usually from October to April. It blows with a steadiness similar to that of the trade winds, often attaining the speed of a moderate gale (28-33 knots). Skies are generally clear during this season, and there is relatively little rain.

The general circulation is further modified by winds of cyclonic origin and various local winds. Some common local winds are listed by local name below:

Barat	A heavy northwest squall in Manado Bay on the north coast of the island of Celebes, prevalent from December to February.
Barber	A strong wind carrying damp snow or sleet and spray that freezes upon contact with objects, especially the beard and hair.
Bayamo	A violent wind blowing from the land on the south coast of Cuba, especially near the Bight of Bayamo.
Bentu de Soli	An east wind on the coast of Sardinia.
Bora	A cold, northerly wind blowing from the Hungarian basin into the Adriatic Sea. See also FALL WIND.
Borasco	A thunderstorm or violent squall, especially in the Mediterranean.
Brisa, Briza	1. A northeast wind which blows on the coast of South America or an east wind which blows on Puerto Rico during the trade wind season. 2. The northeast monsoon in the Philippines.
Brisote	The northeast trade wind when it is blowing stronger than usual on Cuba.
Brubu	A name for a squall in the East Indies.
Bull's Eye Squall	A fair weather squall characteristic of the ocean off the coast of South Africa. It is named for the peculiar appearance of the small isolated cloud marking the top of the invisible vortex of the storm.
Cape Doctor	The strong southeast wind which blows on the South African coast. Also called the DOCTOR.
Caver, Kaver	A gentle breeze in the Hebrides.
Chubasco	A violent squall with thunder and lightning, encountered during the rainy season along the west coast of Central America.
Churada	A severe rain squall in the Mariana Islands during the northeast monsoon. They occur from November to April or May, especially from January through March.
Cierzo	See MISTRAL.
Contrastes	Winds a short distance apart blowing from opposite quadrants, frequent in the spring and fall in the western Mediterranean.
Cordonazo	The "Lash of St. Francis." Name applied locally to southerly hurricane winds along the west coast of Mexico. It is associated with tropical cyclones in the southeastern North Pacific Ocean. These storms may occur from May to November, but ordinarily affect the coastal areas most severely near or after the Feast of St. Francis, October 4.
Coromell	A night land breeze prevailing from November to May at La Paz, near the southern extremity of the Gulf of California.
Doctor	1. A cooling sea breeze in the Tropics. 2. See HARMATTAN. 3. The strong SE wind which blows on the south African coast. Usually called CAPE DOCTOR.
Elephanta	A strong southerly or southeasterly wind which blows on the Malabar coast of India during the months of September and October and marks the end of the southwest monsoon.
Etesian	A refreshing northerly summer wind of the Mediterranean, especially over the Aegean Sea.
Gregale	A strong northeast wind of the central Mediterranean.
Harmattan	The dry, dusty trade wind blowing off the Sahara Desert across the Gulf of Guinea and the Cape Verde Islands. Sometimes called the DOCTOR because of its supposed healthful properties.
Knik Wind	A strong southeast wind in the vicinity of Palmer, Alaska, most frequent in the winter.
Kona Storm	A storm over the Hawaiian Islands, characterized by strong southerly or southwesterly winds and heavy rains.
Leste	A hot, dry, easterly wind of the Madeira and Canary Islands.

Levanter	A strong easterly wind of the Mediterranean, especially in the Strait of Gibraltar, attended by cloudy, foggy, and sometimes rainy weather especially in winter.
Levantera	A persistent east wind of the Adriatic, usually accompanied by cloudy weather.
Levanto	A hot southeasterly wind which blows over the Canary Islands.
Leveche	A warm wind in Spain, either a foehn or a hot southerly wind in advance of a low pressure area moving from the Sahara Desert. Called a SIROCCO in other parts of the Mediterranean area.
Maestro	A northwesterly wind with fine weather which blows, especially in summer, in the Adriatic. It is most frequent on the western shore. This wind is also found on the coasts of Corsica and Sardinia.
Matanuska Wind	A strong, gusty, northeast wind which occasionally occurs during the winter in the vicinity of Palmer, Alaska.
Mistral	A cold, dry wind blowing from the north over the northwest coast of the Mediterranean Sea, particularly over the Gulf of Lions. Also called CIERZO. See also FALL WIND.
Morning Glory	A rare meteorological phenomenon consisting of a low-level atmospheric solitary wave and associated cloud, occasionally observed in different locations around the world. The wave often occurs as an amplitude-ordered series of waves forming bands of roll clouds. Regularly occurs in the southern part of the Gulf of Carpentaria.
Norte	A strong cold northeasterly wind which blows in Mexico and on the shores of the Gulf of Mexico. It results from an outbreak of cold air from the north. It is the Mexican extension of a norther.
Nashi, N'aschi	A northeast wind which occurs in winter on the Iranian coast of the Persian Gulf, especially near the entrance to the gulf, and also on the Makran coast. It is probably associated with an outflow from the central Asiatic anticyclone which extends over the high land of Iran. It is similar in character but less severe than the BORA.
Papagayo	A violent northeasterly fall wind on the Pacific coast of Nicaragua and Guatemala. It consists of the cold air mass of a <i>norte</i> which has overridden the mountains of Central America. See also TEHUANTEPECER.
Pampero	A fall wind of the Argentine coast.
Santa Ana	A strong, hot, dry wind blowing out into San Pedro Channel from the southern California desert through Santa Ana Pass.
Shamal	A summer northwesterly wind blowing over Iraq and the Persian Gulf, often strong during the day, but decreasing at night.
Sharki	A southeasterly wind which sometimes blows in the Persian Gulf.
Sirocco	A warm wind of the Mediterranean area, either a foehn or a hot southerly wind in advance of a low pressure area moving from the Sahara or Arabian deserts. Called LEVECHE in Spain.
Squamish	A strong and often violent wind occurring in many of the fjords of British Columbia. Squamishes occur in those fjords oriented in a northeast-southwest or east-west direction where cold polar air can be funneled westward. They are notable in Jervis, Toba, and Bute inlets and in Dean Channel and Portland Canal. Squamishes lose their strength when free of the confining fjords and are not noticeable 15 to 20 miles offshore.
Suestado	A storm with southeast gales, caused by intense cyclonic activity off the coasts of Argentina and Uruguay, which affects the southern part of the coast of Brazil in the winter.
Sumatra	A squall with violent thunder, lightning, and rain, which blows at night in the Malacca Straits, especially during the southwest monsoon. It is intensified by strong mountain breezes.
Taku Wind	A strong, gusty, east-northeast wind, occurring in the vicinity of Juneau, Alaska, between October and March. At the mouth of the Taku River, after which it is named, it sometimes attains hurricane force.

Tehuantepecer	A violent squally wind from north or north-northeast in the Gulf of Tehuantepec (south of southern Mexico) in winter. It originates in the Gulf of Mexico as a norther which crosses the isthmus and blows through the gap between the Mexican and Guatemalan mountains. It may be felt up to 100 miles out to sea. See also PAPAGAYO.
Tramontana	A northeasterly or northerly winter wind off the west coast of Italy. It is a fresh wind of the fine weather mistral type.
Vardar	A cold fall wind blowing from the northwest down the Vardar valley in Greece to the Gulf of Salonica. It occurs when atmospheric pressure over eastern Europe is higher than over the Aegean Sea, as is often the case in winter. Also called VARDARAC.
Warm Braw	A foehn wind in the Schouten Islands, north of New Guinea.
Williwaw	A sudden blast of wind descending from a mountainous coast to the sea, in the Strait of Magellan or the Aleutian Islands.
White Squall	A sudden, strong gust of wind coming up without warning, noted by whitecaps or white, broken water; usually seen in whirlwind form in clear weather in the tropics.

AIR MASSES

3809. Types of Air Masses

Because of large differences in physical characteristics of the Earth's surface, particularly the oceanic and continental contrasts, the air overlying these surfaces acquires differing values of temperature and moisture. The processes of radiation and convection in the lower portions of the troposphere act in differing characteristic manners for a number of well-defined regions of the Earth. The air overlying these regions acquires characteristics common to the particular area, but contrasts those of other areas. Each distinctive part of the atmosphere, within which common characteristics prevail over a reasonably large area, is called an **air mass**.

Air masses are named according to their source regions. Four regions are generally recognized: (1) equatorial (E), the doldrums area between the north and south trades; (2) tropical (T), the trade wind and lower temperate regions; (3) polar (P), the higher temperate latitudes; and (4) Arctic or Antarctic (A), the north or south polar regions of ice and snow. This classification is a general indication of relative temperature, as well as latitude of origin.

Air masses are further classified as maritime (m) or continental (c), depending upon whether they form over water or land. This classification is an indication of the relative moisture content of the air mass. Tropical air might be designated maritime tropical (mT) or continental tropical (cT). Similarly, polar air may be either maritime polar (mP) or continental polar (cP). Arctic/Antarctic air, due to the predominance of landmasses and ice fields in the high latitudes, is rarely maritime Arctic (mA). Equatorial air is found exclusively over the ocean surface and is designated neither (cE) nor (mE), but simply (E).

A third classification sometimes applied to tropical and polar air masses indicates whether the air mass is warm (w) or cold (k) relative to the underlying surface. Thus, the symbol mTw indicates maritime tropical air which is

warmer than the underlying surface, and cPk indicates continental polar air which is colder than the underlying surface. The w and k classifications are primarily indications of stability (i.e., change of temperature with increasing height). If the air is cold relative to the surface, the lower portion of the air mass will be heated, resulting in instability (temperature markedly decreases with increasing height) as the warmer air tends to rise by convection. Conversely, if the air is warm relative to the surface, the lower portion of the air mass is cooled, tending to remain close to the surface. This is a stable condition (temperature increases with increasing height).

Two other types of air masses are sometimes recognized. These are monsoon (M), a transitional form between cP and E; and superior (S), a special type formed in the free atmosphere by the sinking and consequent warming of air aloft.

Atmospheric pressure is directly related to the density of the air mass above any given point on the Earth's surface. Temperature distribution is the most significant regulator or contributor to atmospheric density. Since temperature decreases considerably as you move higher in the troposphere, temperature (density) distribution in the lower troposphere contributes greatly to atmospheric pressure measured at sea-level. Air masses not only are characterized by temperature and moisture, but they also represent distributions of sea-level pressure. Examples of characteristic weather systems associated with air masses include the Arctic High, Bermuda High, Aleutian Low, Icelandic Low, Siberian High, and the Azores High.

3810. Isobars and Wind

Isobars are lines that connect points of equal sea-level pressure across the Earth's surface. Isobars can be thought of as lines of equal density and representative of the three dimensional density structure of the atmosphere. The

distance between isobars changes depending on the density difference; the closer the isobars are together, the greater the pressure difference or pressure gradient. As mentioned earlier in this chapter, the pressure gradient or pressure gradient force at sea-level is the force that drives the wind over the ocean.

The graphic in Figure 3810a shows the relationships between the pressure gradient force (PGF), the true wind direction (V), friction (F), and the Coriolis Force (f). The surface winds (V) blow across the isobars at about a 25 to 35 degree angle from higher to lower pressure. V_g is the **geostrophic wind**, the wind in which the **Coriolis Force** (f) and PGF balance each other. At higher levels in the atmosphere the flow becomes more geostrophic due to the reduction in friction away from the surface.

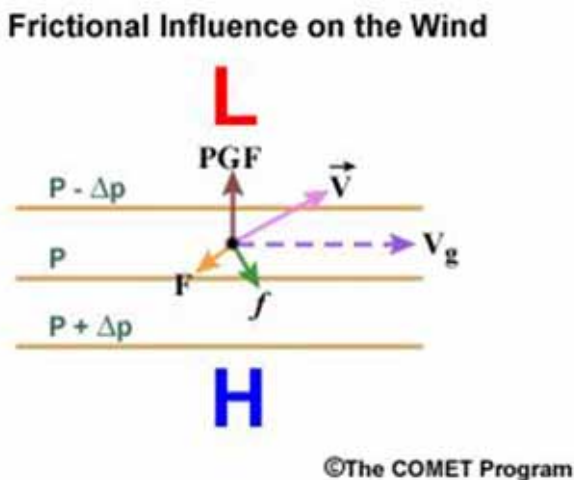

Figure 3810a. A simple pressure gradient of parallel isobars is used to demonstrate that the associated geostrophic wind (V_g) itself would be larger and oriented in a different direction than the real wind (V). The amount of slowing and turning that occurs is dependent on the surface friction (F). The Coriolis force (f) is always directed to the right of the real wind in the Northern Hemisphere and the pressure gradient force (PGF) is always pointed toward lower pressure. Used with permission of UCAR/COMET Program.

In Figure 3810b, isobars define where the pressure centers are located and their intensity is represented by a central pressure in hectopascals. Because average mean sea-level pressure (MSLP) across the globe is 1013.25 hPa, it can be used as a reference to compare any given high or low. The 1035 hPa high in the central Pacific is 22 hPa higher than average; it is a moderate strength high. The 971 hPa low over the western Bering Sea is 42 hPa lower than average and is a strong low. The fronts lie in pressure troughs, as they are concentrated zones of density difference. The closer the isobars are spaced, the higher the wind speed. In the troughs the isobars change direction or turn;

therefore, the wind direction shifts due to the change in isobars.

3811. Cyclone and Anticyclone Air Flow

An area of relatively low pressure is called a **cyclone** and is typically depicted by an L as shown in Figure 3810b. Its counterpart for high pressure is called an **anticyclone** and is shown by an H. These terms are used particularly in connection with the winds associated with such centers. Wind tends to blow from an area of high pressure to one of low pressure, but due to the rotation of the Earth, wind is deflected toward the right in the Northern Hemisphere and toward the left in the Southern Hemisphere. Cyclones tend to occur along the boundaries between air masses or fronts.

Because of the rotation of the Earth, therefore, the circulation tends to be counterclockwise around areas of low pressure and clockwise around areas of high pressure in the Northern Hemisphere, and the speed is proportional to the spacing of isobars. In the Southern Hemisphere, the direction of circulation is reversed. Based upon this condition, a general rule, known as **Buys Ballot's Law**, or the **Baric Wind Law**, can be stated:

If an observer in the Northern Hemisphere faces away from the surface wind, the low pressure is toward his left; the high pressure is toward his right.

If an observer in the Southern Hemisphere faces away from the surface wind, the low pressure is toward his right; the high pressure is toward his left.

In a general way, these relationships apply in the case of the general distribution of pressure, as well as to temporary local pressure systems.

The reason for the wind shift along a front is that the isobars have a change of direction along these lines. Since the direction of the wind is directly related to the direction of isobars, any change in the latter results in a shift in the wind direction. The isobars change direction because the fronts lie in a trough of lower pressure. The trough is in response to a concentrated temperature (density) difference existing.

In the Northern Hemisphere, the wind shifts toward the right (clockwise) when either a warm or cold front passes. In the Southern Hemisphere, the shift is toward the left (counterclockwise). When an observer is on the poleward side of the path of a frontal wave, wind shifts are reversed (i.e., to the left in the Northern Hemisphere and to the right in the Southern Hemisphere).

In an anticyclone, successive isobars are relatively far apart, resulting in light winds. In a cyclone, the isobars are more closely spaced and as mentioned earlier, have a steeper pressure gradient and thus stronger winds. Anticyclones occur within air masses and are not associated with the boundaries between air masses.

Since an anticyclonic area is a region of outflowing winds, air is drawn into it from aloft. Descending air is warmed, and as air becomes warmer, its capacity for holding uncondensed moisture increases. Therefore, clouds tend to

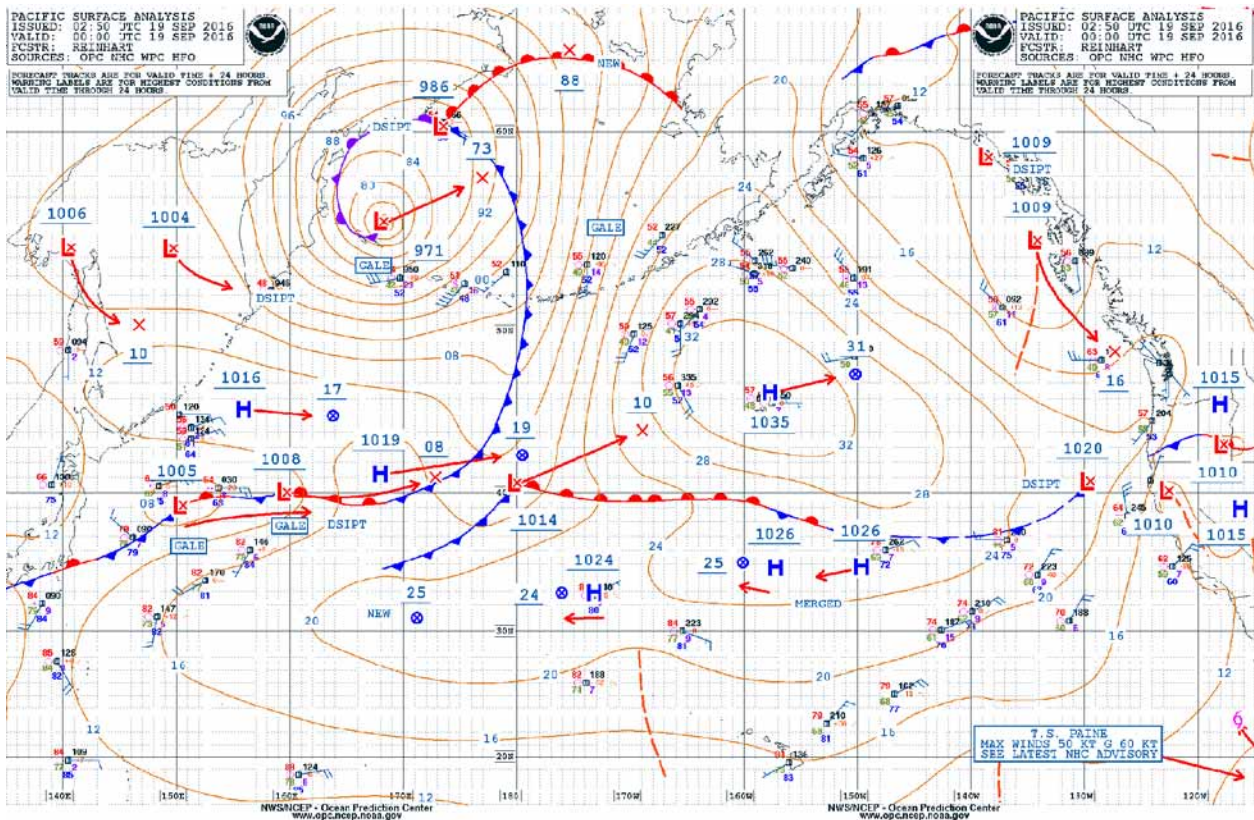

Figure 3810b. Sea-level pressure analysis showing isobars (thin brown solid lines) at 4 hPa intervals, fronts, cyclones (denoted by red L's) and anticyclones (blue H's) for the North Pacific from 0000 UTC 19 September 2016.

dissipate. Clear skies are characteristic of an anticyclone, although scattered clouds and showers are sometimes encountered.

In contrast, a cyclonic area is one of converging winds. The resulting upward movement of air results in cooling, a condition favorable to the formation of clouds and precipitation. More or less continuous rain and generally stormy weather are usually associated with a cyclone.

Between the two hemispheric belts of high pressure associated with the horse latitudes, cyclones form only occasionally over certain areas at sea, generally in summer and fall.

In the areas of the prevailing westerlies, migratory cyclones (lows) and anticyclones (highs) are a common occurrence. These are sometimes called **extra-tropical cyclones** and **extra-tropical anticyclones** to distinguish them from the more violent tropical cyclones. It should be noted that some extra-tropical cyclones do reach hurricane force intensity. Formation of extra-tropical cyclones occurs over sea and land, and the lows intensify as they move poleward. Cyclones begin elongated but as their life cycle proceeds, they become more circular.

3812. Cyclones and Fronts

As air masses move within the general circulation, they travel from their source regions to other areas dominated by air having different temperature and moisture characteristics. Between two air masses a transition of change in temperature, moisture, and wind speed and direction exists. This transition zone is called a **frontal zone** or **front**. Because the frontal zone is a zone of temperature difference in the horizontal and vertical, the density of the atmosphere changes and the isobars form a trough of lower pressure. The stronger the frontal zone, meaning the larger the temperature (density) difference, the lower the pressure in the trough and the stronger the associated winds.

Fronts are represented on weather maps by lines; a cold front is shown with pointed barbs, a warm front with rounded barbs, and an occluded front with both, alternating. The line of the front is placed on the warmest side of the frontal zone. A stationary front is shown with pointed and rounded barbs alternating and on opposite sides of the line with the pointed barbs away from the colder air. The front may take on a wave-like character, becoming a “frontal wave.”

Before the formation of frontal waves, the isobars (lines of equal atmospheric pressure) tend to run parallel to the fronts. As a wave is formed, the pattern is distorted

somewhat, as shown in Figure 3812a. In this illustration, colder air is north of warmer air. In Figure 3812b through Figure 3812d, isobars are drawn at 4-hectopascal intervals.

The wave tends to travel in the direction of the general

circulation, which in the temperate latitudes is usually in an easterly and slightly poleward direction.

In the first stages, these effects are not marked, but as

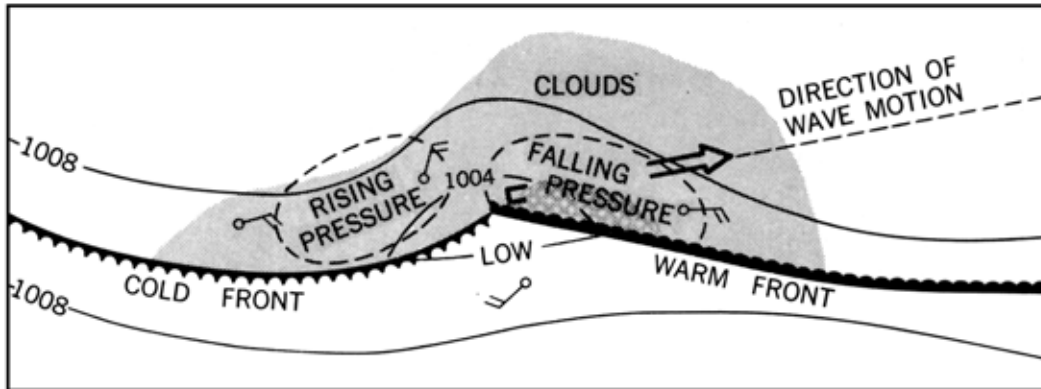

Figure 3812a. First stage in the development of a frontal wave (top view).

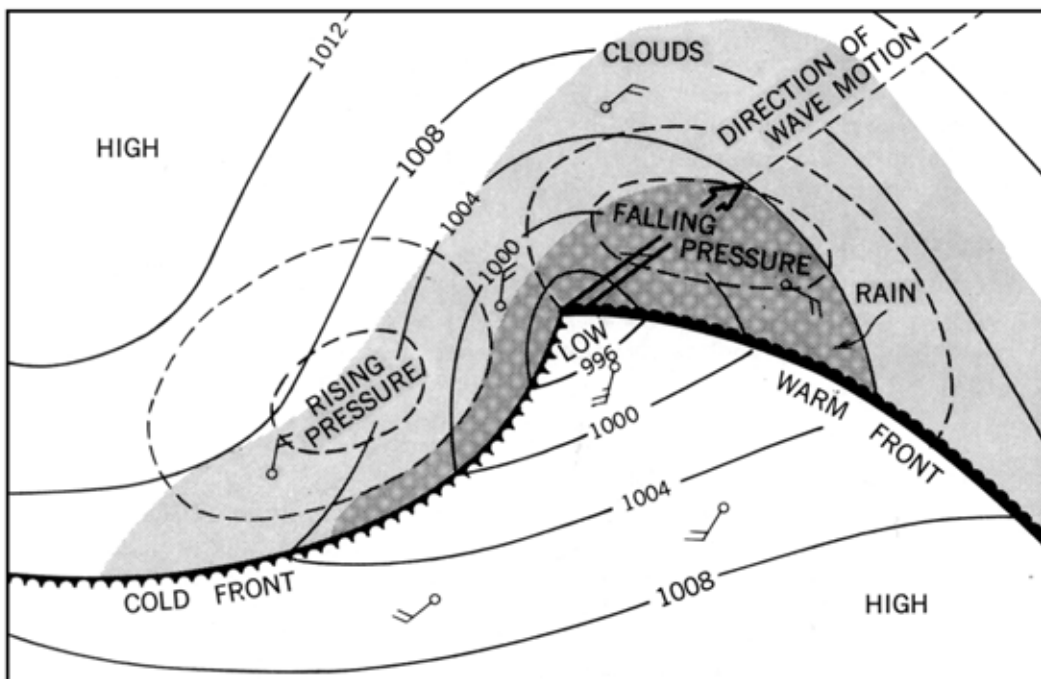

Figure 3812b. A fully developed frontal wave (top view).

the wave continues to grow, they become more pronounced, as shown in Figure 3812b. As the amplitude of the wave increases, pressure near the center usually decreases, and the low is said to “deepen.” As it deepens, its forward speed generally decreases.

Along the leading edge of the wave, warmer air is replacing colder air. This is called the **warm front**. The

trailing edge is the **cold front**, where colder air is under-running and displacing warmer air.

As the warm front passes, the temperature rises, the wind shifts clockwise (in the Northern Hemisphere), and the steady rain stops. Drizzle may fall from low-lying stratus clouds, or there may be fog for some time after the wind shift. During passage of the warm sector between the warm front

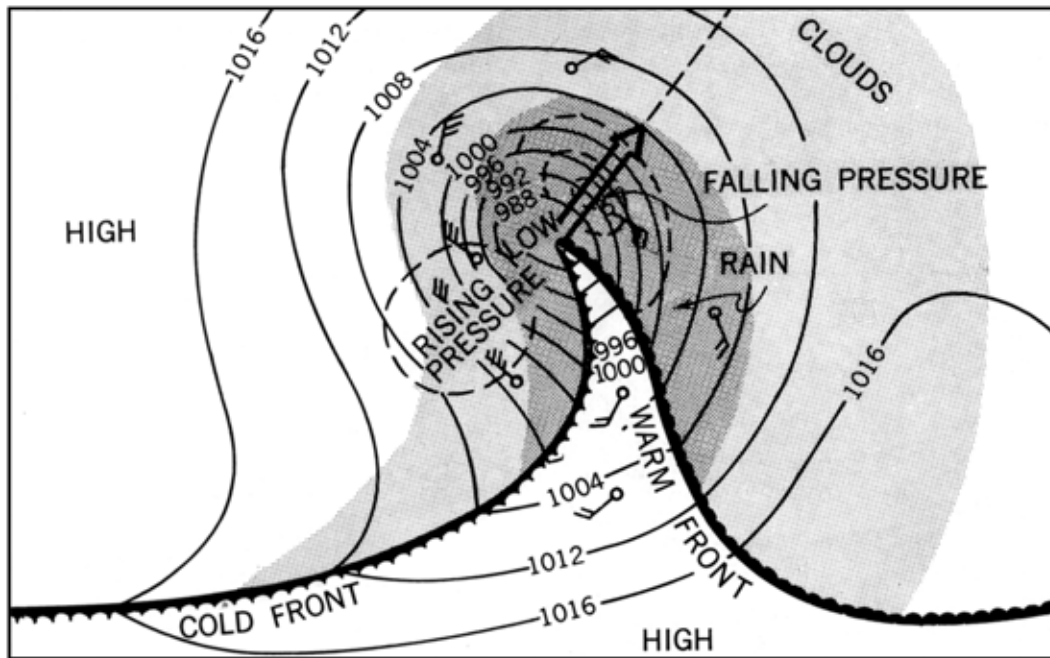

Figure 3812c. A frontal wave nearing occlusion (top view).

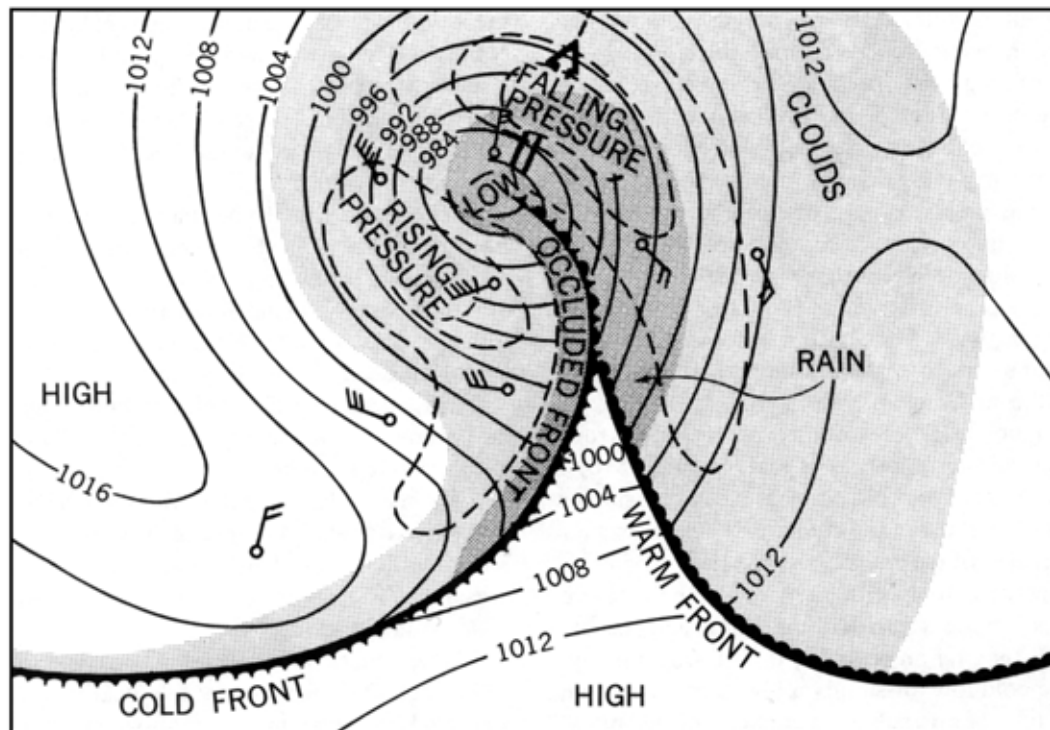

Figure 3812d. An occluded front (top view).

and the cold front, there is little change in temperature or pressure. However, if the wave is still growing and the low deepening, the pressure might slowly decrease. In the warm sector the skies are generally clear or partly cloudy, with cu-

mulus or stratocumulus clouds most frequent. The warm air is usually moist, and haze or fog may often be present.

The warm air, being less dense, tends to ride up greatly over the colder air it is replacing. Partly because of the re-

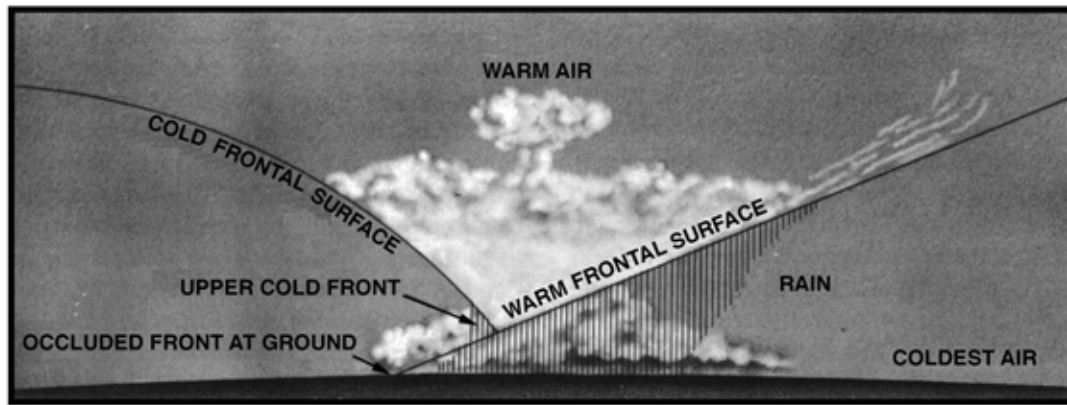

Figure 3812e. An occluded front (cross section).

placement of cold, dense air with warm, light air, the pressure decreases. Since the slope is gentle, the upper part of a warm frontal surface may be many hundreds of miles ahead of the surface portion. The decreasing pressure, indicated by a “falling barometer,” is often an indication of the approach of such a wave. In a slow-moving, well-developed wave, the barometer may begin to fall several days before the wave arrives. Thus, the amount and nature of the change of atmospheric pressure between observations, called **pressure tendency**, is of assistance in predicting the approach of such a system.

The advancing cold air, being more dense, tends to ride under the warmer air at the cold front, lifting it to greater heights. The slope here is such that the upper-air portion of the cold front is behind the surface position relative to its motion. After a cold front has passed, the pressure increases, giving a rising barometer.

The approach of a well-developed warm front (i.e., when the warm air is mT) is usually heralded not only by falling pressure, but also by a more-or-less regular sequence of clouds. First, cirrus appear. These give way successively to cirrostratus, altostratus, altocumulus, and nimbostratus. Brief showers may precede the steady rain accompanying the nimbostratus.

As the faster moving, steeper cold front passes, the wind veers (shifts clockwise in the Northern Hemisphere and counterclockwise in the Southern Hemisphere), the temperature falls rapidly, and there are often brief and sometimes violent **squalls** with showers, frequently accompanied by thunder and lightning. Clouds are usually of the convective type. A cold front usually coincides with a well-defined wind-shift line (a line along which the wind shifts abruptly from southerly or southwesterly to northerly or northwesterly in the Northern Hemisphere, and from northerly or northwesterly to southerly or southwesterly in the Southern Hemisphere). At sea, a series of brief showers accompanied by strong, shifting winds may occur along or some distance (up to 200 miles) ahead of a cold front. These

are called squalls (in common nautical use, the term **squall** may be additionally applied to any severe local storm accompanied by gusty winds, precipitation, thunder, and lightning), and the line along which they occur is called a **squall line**.

Because of its greater speed and steeper slope, which may approach or even exceed the vertical near the Earth's surface (due to friction), a cold front and its associated weather pass more quickly than a warm front. After a cold front passes, the pressure rises, often quite rapidly, the visibility usually improves, and the clouds tend to diminish. Clear, cool or cold air replaces the warm hazy air.

As the wave progresses and the cold front approaches the slower moving warm front, the low becomes deeper and the warm sector becomes smaller, as shown in Figure 3812c.

Finally, when the two parts of the cold air mass meet, the warmer portion tends to rise above the colder part as shown in Figure 3812e. The warm air continues to rise until the entire frontal system dissipates. The catch up mechanism of the cold front overtaking the warm front to form the occlusion is best described as a roll up of frontal zones (isotherms, lines of equal temperature) and not a catching up of fronts.

As the warmer air is replaced by colder air, the pressure gradually rises, a process called **filling**. This usually occurs within a few days after an occluded front forms. Finally, there results a cold low, or simply a low pressure system across which little or no gradient in temperature and moisture can be found.

The sequence of weather associated with a low depends greatly upon the observer's location with respect to the path of the center. That described previously assumes that the low center passes poleward of the observer. If the low center passes south of the observer, between the observer and the equator, the abrupt weather changes associated with the passage of fronts are not experienced. Instead, the change from the weather characteristically

found ahead of a warm front, to that behind a cold front, takes place gradually. The exact sequence is dictated by the distance from the center, the severity and age of the low.

Although each low generally follows this pattern, no two are ever exactly alike. Other centers of low pressure and high pressure, and the air masses associated with them, even though they may be 1,000 miles or more away, influence the formation and motion of individual low centers and their accompanying weather. Particularly, a high stalls or diverts a low. This is true of temporary highs as well as semi-permanent highs, but not to as great a degree.

Studies of explosively intensifying maritime cyclones in the late 1980's and early 1990s revealed an alternative

model to portray the evolution of frontal cyclones over the oceans. This model is shown in Figure 3812f and was developed after studying numerical model results and data acquired by research aircraft. It is commonly called the **Shapiro Keyser Model**. Four phases of development were identified: the incipient frontal wave (I), the frontal fracture (II), bent-back front and frontal T-bone (III), and warm core seclusion (IV). This model related the frontal evolution (top portion of Figure 3812f) with the amplification and roll up of the thermal wave by displaying the changes in the temperature structure and air flows over time (as shown in the bottom illustrations of Figure 3812f).

Similar to the earlier description, a frontal wave devel-

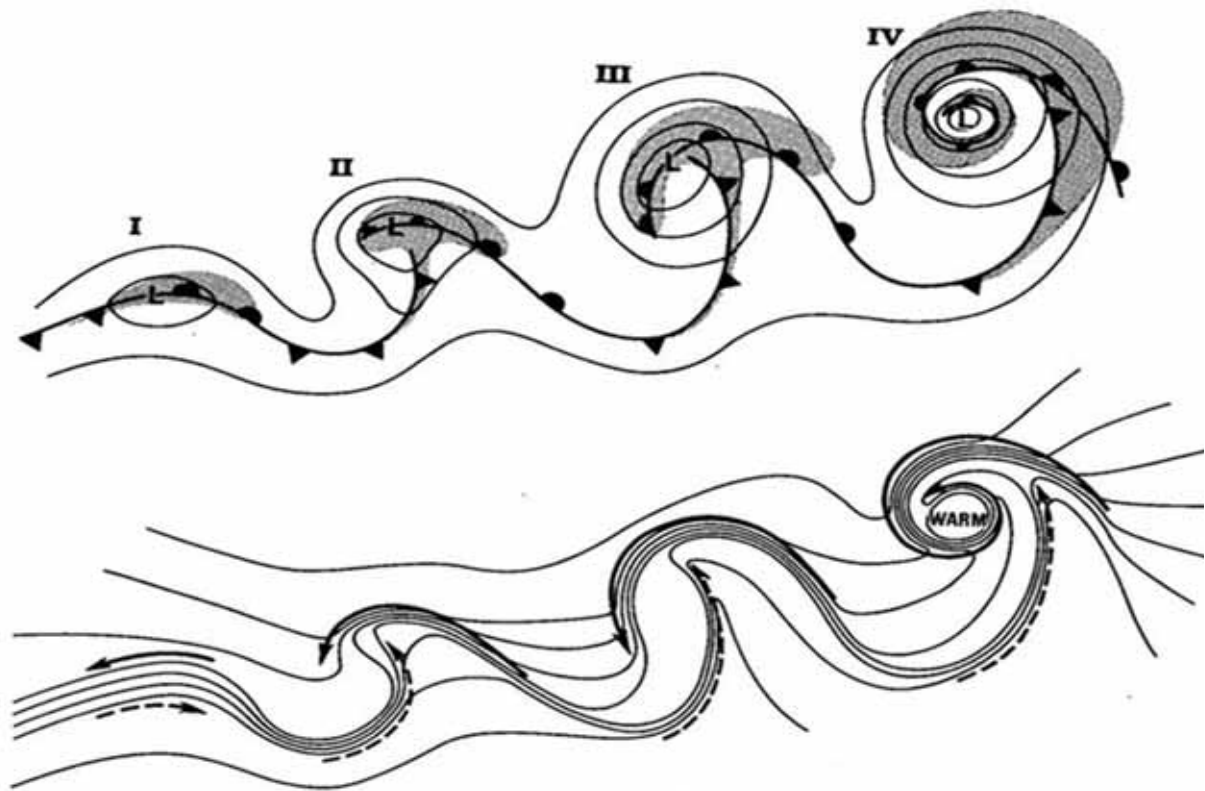

Figure 3812f. Evolution of a maritime cyclone from Shapiro and Keyser 1990. The four phases of evolution are from left to right: incipient frontal wave (I), frontal fracture (II), bent-back front and frontal T-bone (III), and warm core seclusion (IV).

Top series showing evolution over time of isobars, fronts, and cloud pattern. Bottom series showing cold and warm airflows—solid and dashed arrows, and isotherms (lines of equal temperature)—solid thin lines.

ops on a pre-existing frontal zone as a kink in the temperature gradient (phase I). The front separates the colder easterly flow from the warmer westerly flow to the south of the front. Clouds and precipitation mainly occur to the east of the developing low pressure and north of the developing warm front.

In the frontal fracture (phase II), the thermal wave has amplified with isotherms (lines of constant temperature) contracting as the temperature gradients along the fronts

strengthen. The cold front has separated (fractured) from the warm front as can be seen below phase II in Figure 3812f. The warm front has extended to the west of the developing low center as the temperature gradient has strengthened to the west of the low pressure center. The temperature frontal wave has taken on more of a T shape with two distinct fronts and airflows. The cold front is fractured from the warm front because the temperature gradient immediately south of the low is weak but strengthens as one

moves farther south along the cold.

The process continues in phase III as the frontal wave continues to amplify. Temperature gradients continue to constrict as they intensify and thus the fronts strengthen. The warm front that extended further west of the low center in from phase II begins to wrap eastward under (equatorward of) the low center. At this point it is referred to as the bent-back front. Often the highest winds in this phase are on the cold side (west, in this case) of the bent-back front where the isobars have the tightest packing or gradient. This is in the vicinity of the arrow head in the bottom image of phase III.

Phase IV is the mature phase of the evolution. In this final phase, the bent-back front has encircled the low pressure center as the thermal wave rolls up like an ocean wave. In the lower troposphere, warm air has pooled over the vicinity of the low center and is surrounded by cooler air. This warm pool is called a **warm seclusion** and is a sign of the cyclone nearing or reaching its lowest pressure and strongest intensity. Highest winds often occur equatorward (south and southwest in the Northern Hemisphere) of the low center on the cold side of the bent-back front. Warm se-

clusions were once thought to be rare but are a frequent occurrence in strong ocean cyclones. Wind speed estimates from space-based radar instruments called **scatterometers** often show the highest winds in this region on the cold (equatorward) side of the encircling bent-back front.

3813. Ocean Storm Evolution Example

The following are examples of a North Atlantic storm from 2011 that reached hurricane force strength. The series of four graphics (as seen in Figures 3413a through d) includes infrared (thermal) satellite imagery of clouds, sea-level pressure, wind speed, and infrared satellite image for phases I, II, III, and IV of the cyclone. The graphics illustrate the relationship between the frontal evolution of the fronts and the wind field. Each cyclone is different due to the complexity of the atmosphere; however, the main frontal features and wind field are fairly typical of a winter maritime cyclone in either the North Atlantic or Pacific. Wind speeds are shown by the color bar in the center of the figure.

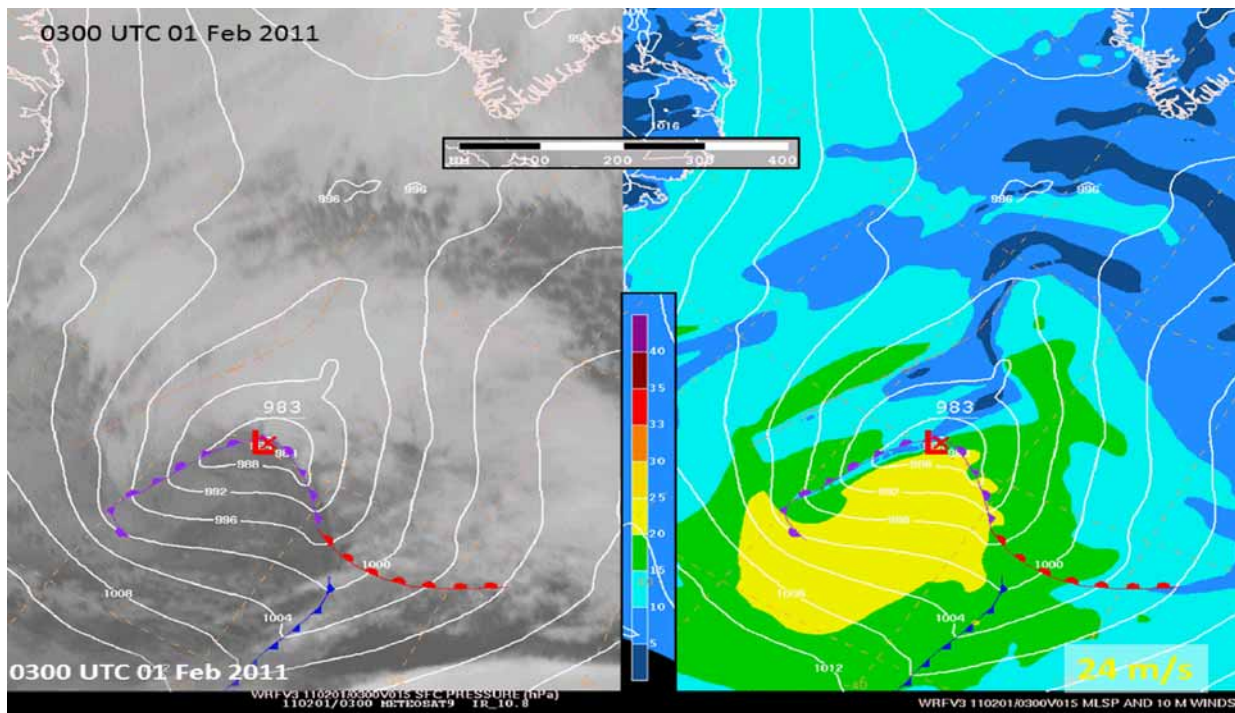

Figure 3813a. Two panel image of a North Atlantic cyclone from 0300 UTC 01 Feb 2011 showing isobars at 4 hPa intervals, infrared satellite image from Meteosat geostationary satellite, fronts, and central pressure (left). On the right panel, isobars and numerical model wind speeds from 10m above the ocean surface colored based on the color bar on the left of the panel. Maximum 10m wind speed is listed in the lower right in m/s showing 24 m/s.

There are three main fronts with this cyclone (Figure 3813a), the warm front (red) extending southeastward from the low center, the cold front (blue) extending south and southwest from the junction of the warm to occluded front,

and the occluded front (purple) extending through the cyclone center and then to the southwest and south well west of the cyclone center. The portion of the occluded front west of the center is the bent-back front or bent-back occlu-

sion. It is very similar to a warm front through the low center and then behaves much more like a cold front to the west. The highest winds in this example at this time were in

the zone south of the low center in the colder air between the bent-back and cold front.

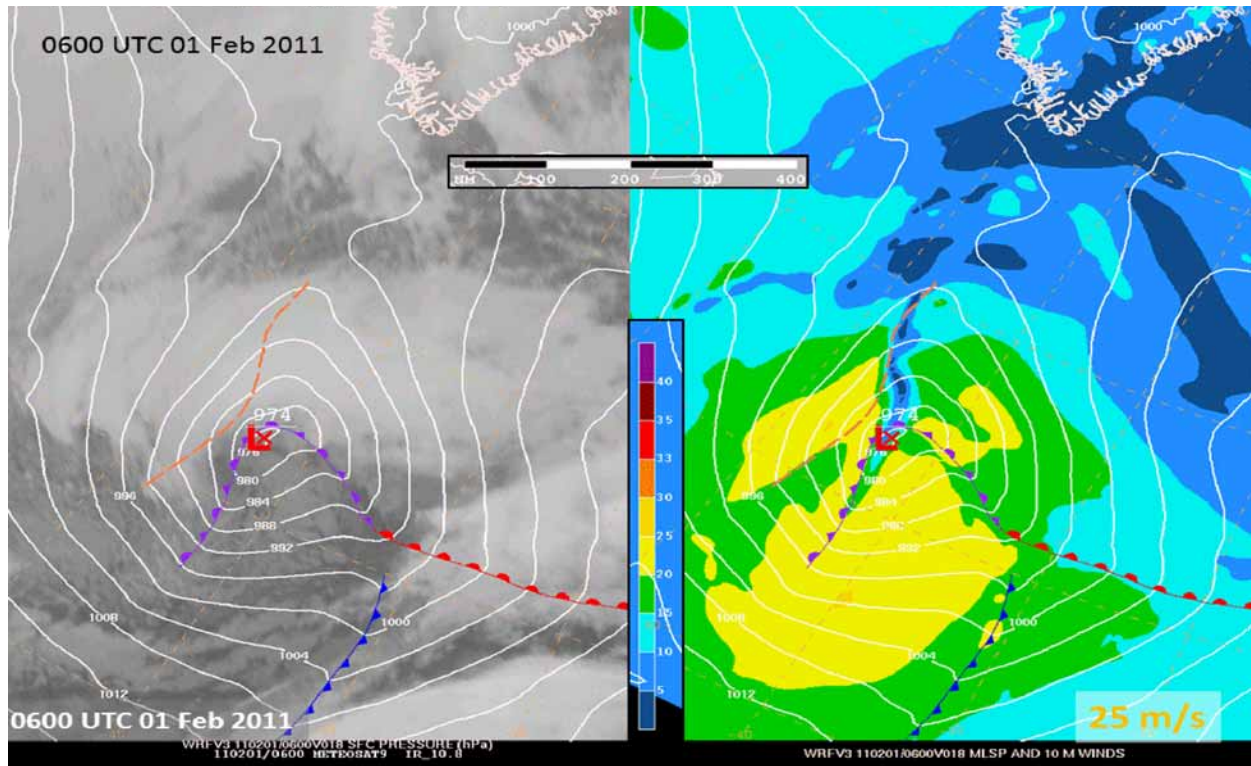

Figure 3813b. As in the previous figure but for 0600 UTC 01 Feb 2011.

Three hours later (Figure 3813b) the cyclone has deepened to 974 hPa and the wind field has expanded with a larger area of winds 20 to 25 m/s. Winds have increased to the east of the low center northeast of the occluded front, to the west of the bent-back, and also to the west of a developing trough of lower pressure to the west of the low center. The bent-back front is sweeping eastward to the south of the low center. Maximum wind speed is 25 m/s.

Another 3 hours have gone by (Figure 3813c) and at 0900 UTC the low center has further dropped in central pressure by 6 hPa in 3 hours. The wind field has further expanded and more importantly, the area of maximum wind speeds is concentrated to the southwest of the bent-back front. Comparing to the 0600 UTC, the bent-back front has continued to wrap eastward to the south of the low center and the wind speeds immediately southwest of the bent-back front have increased to 30 to 34 m/s or hurricane force. The highest wind speeds are often found in this region of intensifying ocean cyclones. The fronts continue to lie in pressure troughs delineating both wind shifts and wind maxima. To the north of the low the trough of lower pressure (dashed orange/brown line at 0300 and 0600 UTC) has strengthened into a frontal zone that behaves similarly to a warm front. In this case this northwestward pointing frontal zone separates modified cold air north of the warm and occluded fronts from colder and more dense Arctic air from

northern Canada and the Labrador Sea.

In the final image (Figure 3813d) a narrow zone of very intense winds lies immediately to the south of the bent-back front with a core of winds well into hurricane force of 35 m/s. Maximum wind speed was 36 m/s per the numerical model used to represent this storm. Satellite radar-based wind speed estimates also showed winds to hurricane force. The cold frontal fracture has expanded and the isobars south of the warm to occluded juncture change direction only gradually. The gradual turning of the isobars means there is no longer a concentrated zone of temperature difference in this area. It does not mean there is no temperature difference, just that the difference occurs over a broad zone. The significant frontal zones are associated with the warm front, occluded front, the bent-back to the south of the low center and the stationary front extending northwest from the bent-back front. Notice that a wind maximum lies adjacent and on the cold side of each frontal zone. This illustrates that fronts and their evolution have a very important relationship to the wind field evolution. In this maturing phase of the cyclone, warm air has been advected or drawn into the region above the cyclone center and is surrounded by colder air. This zone of warmer air is called the warm seclusion, thus the warm seclusion phase of the cyclone evolution. On the south side of the warm seclusion is a very intense zone of temperature difference or gradient associat-

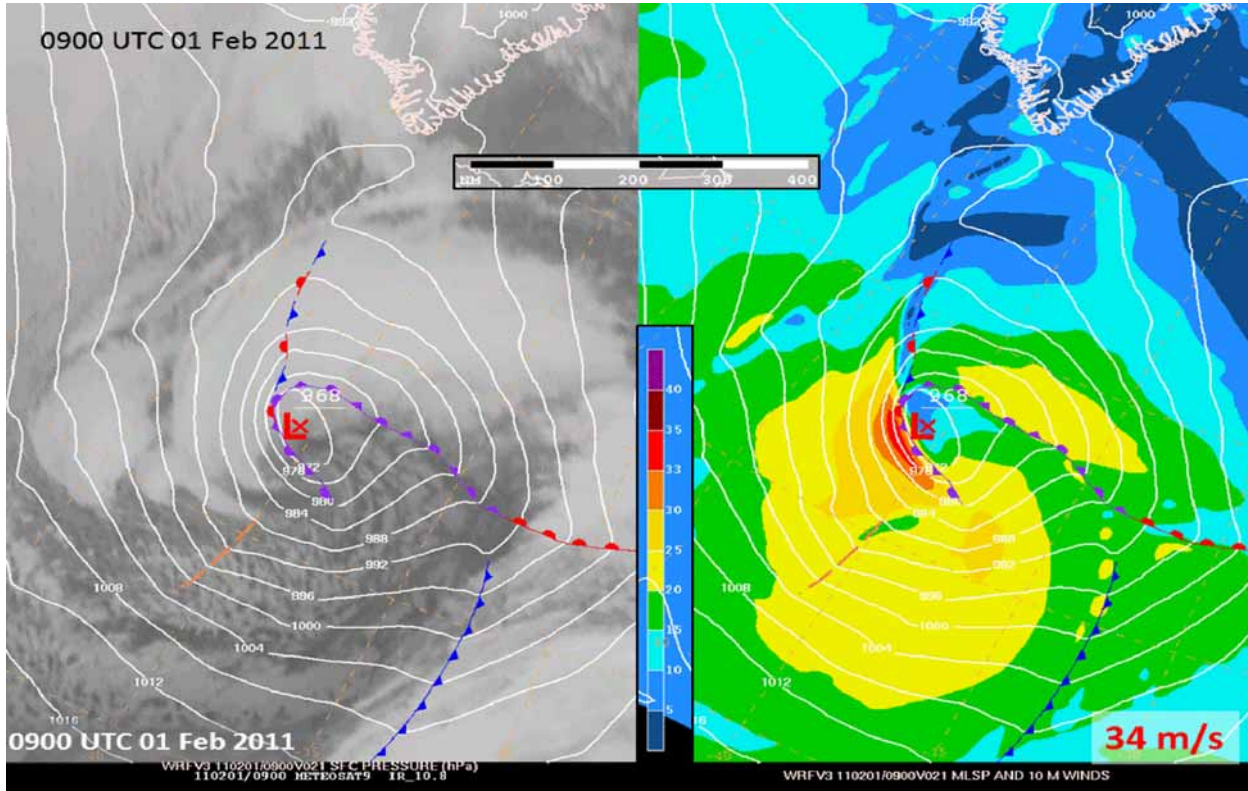

Figure 3813c. As in the previous figure but for 0900 UTC 01 Feb 2011.

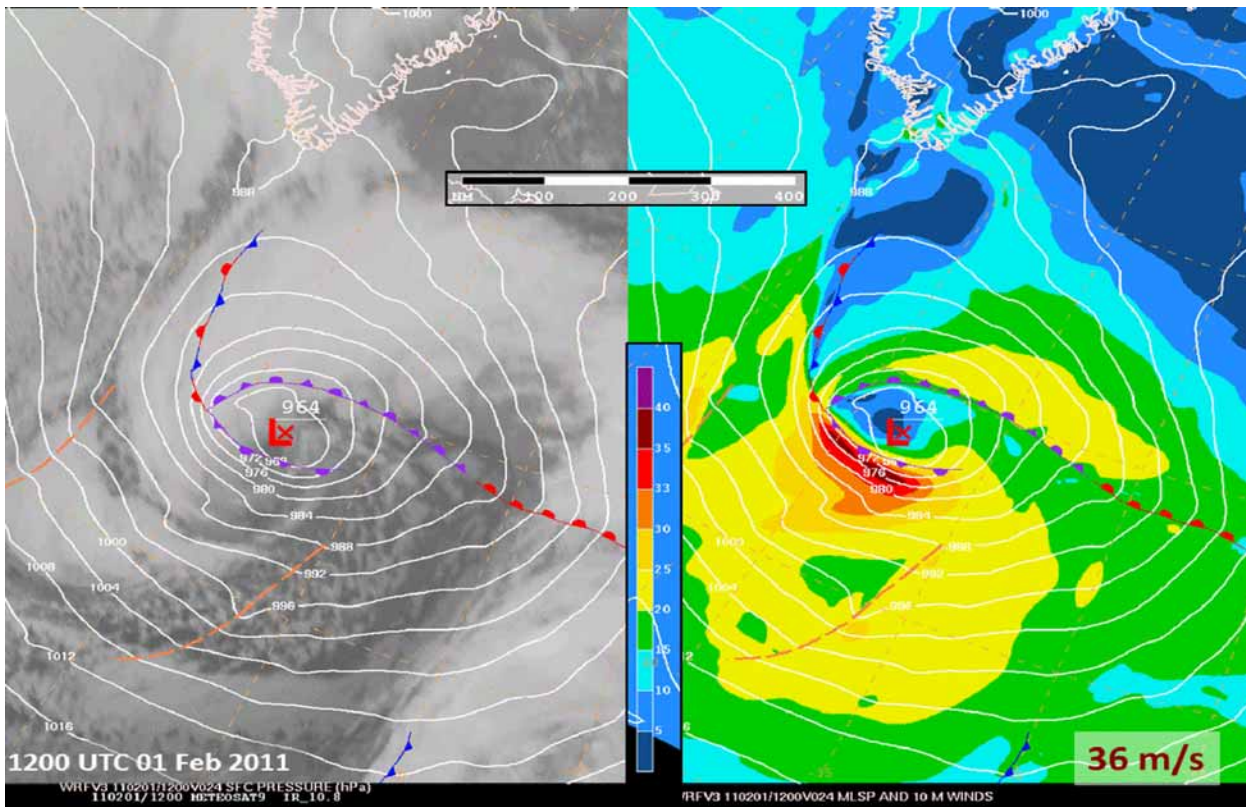

Figure 3813d. As in the previous figure but for 1200 UTC 01 Feb 2011.

ed with the bent-back front. Often this bent-back frontal zone is the strongest zone of temperature contrast during the life of the storm. The atmosphere compensates for this intense frontal zone by developing very high winds near the ocean surface. It is in this area that forecasters often observe violent storm or hurricane force winds. It is also a favored area for extreme waves to develop, occasionally in excess of 15 to 20 m.

By 1200 UTC the cyclone has reached a central pressure of 964 hPa, a drop of 19 hPa in 9 hours. A rough rule of thumb for a cyclone to explosively deepen is for the central pressure to drop at a rate of 1 hPa per hour. This cyclone has deepened over 2 hPa per hour. Rapidly intensifying ocean cyclones that deepened 24 hPa or greater in 24 hours are called “**bombs**” or **meteorological bombs**. Deepening rates that qualify as “bombs” vary with latitude with 1 hPa

reduction in central pressure per hour (24 hPa in 24 hours) being valid at 60 degrees latitude. Poleward of 60 degrees, the rate required for a “bomb” is greater than 1 hPa per hour. Equatorward, the required rate for a “bomb” is less than 1 hPa/hour. The cyclone illustrated here qualifies as a strong bomb. Graphical weather analyses and forecasts issued by the U.S. National Weather Service use the phrase Rapidly Intensifying (RPDLY INTSFYG) to highlight potential explosive intensification.

Earlier depictions of cyclone evolution and the occlusion process have value such as where to expect pressure falls and rises, precipitation, wind shifts, and clouds. Utilizing satellite-sensed winds and waves and numerical forecast models, suggest that the Shapiro-Keyser Cyclone evolution from frontal wave to mature warm seclusion well represents the latest in understanding.

LOCAL WEATHER PHENOMENA

3814. Local Winds

In addition to the winds of the general circulation and those associated with migratory cyclones and anticyclones, there are numerous local winds which influence the weather in various places.

Varying conditions of topography produce a large variety of local winds throughout the world. Winds tend to follow valleys, and tend to deflect from high banks and shores. In mountain areas wind flows in response to temperature distribution and gravity. An **anabolic wind** is one that blows up an incline, usually as a result of surface heating. A **katabatic wind** is one which blows down an incline. There are two types, **foehn** and **fall wind**.

The **foehn** (fān) is a warm, dry wind which initiates from horizontally moving air encountering a mountain barrier. As it blows upward to clear the mountains, it is cooled below the dew point, resulting in clouds and rain on the windward side. As the air continues to rise, its rate of cooling is reduced because the condensing water vapor gives off heat to the surrounding atmosphere. After crossing the mountain barrier, the air flows downward along the leeward slope, being warmed by compression as it descends to lower levels. Since it loses less heat on the ascent than it gains during descent, and since it has lost its moisture during ascent, it arrives at the bottom of the mountains as very warm, dry air. This accounts for the warm, arid regions along the eastern side of the Rocky Mountains and in similar areas. In the Rocky Mountain region this wind is known by the name **chinook**. It may occur at any season of the year, at any hour of the day or night, and have any speed from a gentle breeze to a gale. It may last for several days or for a very short period. Its effect is most marked in winter, when it may cause the temperature to rise as much as 20°F to 30°F within 15 minutes, and cause snow and ice to melt within a few hours. On the west coast of the United States, a foehn wind, given the name **Santa Ana**, blows through a pass and down a val-

ley of that name in Southern California. This wind is frequently very strong and may endanger small craft immediately off the coast.

A cold wind blowing down an incline is called a **fall wind**. Although it is warmed somewhat during descent, as is the foehn, it remains cold relative to the surrounding air. It occurs when cold air is dammed up in great quantity on the windward side of a mountain and then spills over suddenly, usually as an overwhelming surge down the other side. It is usually quite violent, sometimes reaching hurricane force. A different name for this type wind is given at each place where it is common. The **tehuantepecer** of the Mexican and Central American coast, the **pampero** of the Argentine coast, the **mistral** of the western Mediterranean, and the **bora** of the eastern Mediterranean are examples of this wind.

Many other local winds common to certain areas have been given distinctive names. A **blizzard** is a violent, intensely cold wind laden with snow mostly or entirely picked up from the ground, although the term is often used popularly to refer to any heavy snowfall accompanied by strong wind. A **dust whirl** is a rotating column of air about 100 to 300 feet in height, carrying dust, leaves, and other light material. This wind, which is similar to a waterspout at sea, is given various local names such as dust devil in southwestern United States and desert devil in South Africa. A gust is a sudden, brief increase in wind speed, followed by a slackening, or the violent wind or squall that accompanies a thunderstorm. A puff of wind or a light breeze affecting a small area, such as would cause patches of ripples on the surface of water, is called a **cat's paw**.

The most common are the land and sea breezes, caused by alternate heating and cooling of land adjacent to water. The effect is similar to that which causes the monsoons, but on a much smaller scale, and over shorter periods. By day the land is warmer than the water, and by night it is cooler. This effect occurs along many coasts during the summer.

Between about 0900 and 1100 local time the temperature of the land becomes greater than that of the adjacent water. The lower levels of air over the land are warmed, and the air rises, drawing in cooler air from the sea. This is the **sea breeze** and is shown in Figure 3814a. Late in the afternoon, when the Sun is low in the sky, the temperature of the two surfaces equalizes and the breeze stops. After sunset, as the land cools below the sea temperature, the air above it is also cooled. The contracting cool air becomes more dense, increasing the pressure near the surface. This results in an outflow of winds to the sea. This is the **land breeze**, which blows during the night and dies away near sunrise. The land breeze is illustrated in Figure 3814b. Since the atmospheric pressure changes associated with this cycle are not great, the accompanying winds generally do not exceed gentle to moderate breezes. The circulation is usually of limited extent reaching a distance of perhaps 20 miles inland, not more than 5 or 6 miles offshore, and to a height of a few hundred feet. In the doldrums and subtropics, this process is repeated with great regularity throughout most of the year. As the latitude increases, it becomes less prominent, being masked by winds of migratory cyclones and anticyclones. However, the effect often may be present to reinforce, retard, or deflect stronger prevailing winds.

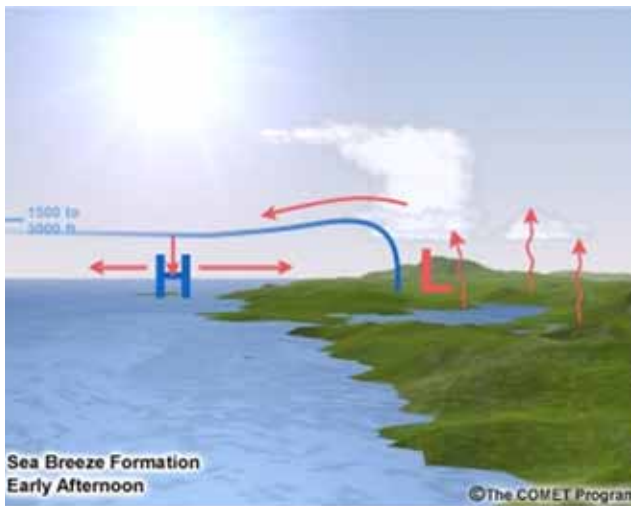

Figure 3814a. Sea breeze formation in the early afternoon. Used with permission of UCAR/COMET Program.

3815. Waterspouts

A **waterspout** is a small, whirling storm over ocean or inland waters. Its chief characteristic is a tall, funnel-shaped cloud; when fully developed it is usually attached to the base of a cumulus cloud. See Figure 3815. The water in a waterspout is mostly confined to its lower portion, and may be either salt spray drawn up by the sea surface, or freshwater resulting from condensation due to the lowered pressure in the center of the vortex creating the spout. The air in waterspouts may rotate clockwise or counterclockwise,

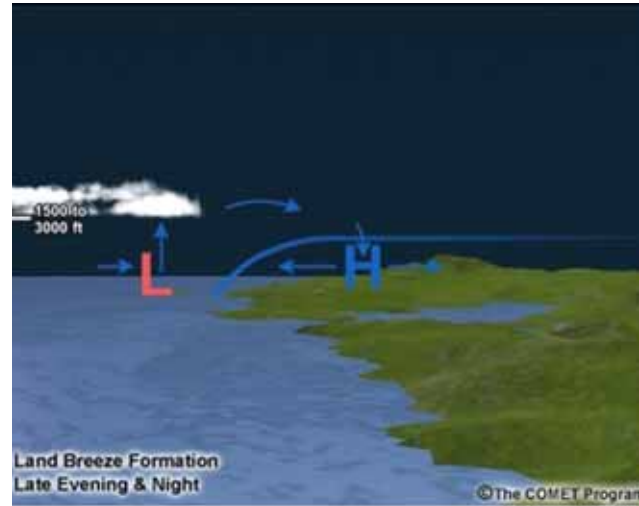

Figure 3814b. Land breeze formation in the late evening and at night. Used with permission of UCAR/COMET Program.

depending on the manner of formation. They are found most frequently in tropical regions, but are not uncommon in higher latitudes.

There are two types of waterspouts: **tornadoes** which are those derived from violent convective storms over land moving seaward, and those formed over the sea and which are associated with fair or foul weather. The latter type is most common, lasts a maximum of 1 hour, and has variable strength. Many waterspouts are no stronger than dust whirlwinds, which they resemble; at other times they are strong enough to destroy small craft or to cause damage to larger vessels, although modern ocean-going vessels have little to fear.

Waterspouts vary in diameter from a few feet to several hundred feet, and in height from a few hundred feet to several thousand feet. Sometimes they assume fantastic shapes; in early stages of development an elongated hour glass shape between cloud and sea is common. Since a waterspout is often inclined to the vertical, its actual length may be much greater than indicated by its height.

3816. Deck Ice

Ships traveling through regions where the air temperature is below freezing may acquire thick deposits of ice as a result of salt spray freezing on the rigging, deckhouses, and deck areas. This accumulation of ice is called **ice accretion**. Also, precipitation may freeze to the superstructure and exposed areas of the vessel, increasing the load of ice. See Figure 3816.

On small vessels in heavy seas and freezing weather, deck ice may accumulate very rapidly and increase the topside weight enough to capsize the vessel. Accumulations of more than 2 cm per hour are classified as



Figure 3815. Waterspout. Image courtesy of NOAA.

heavy freezing spray. Fishing vessels with outriggers, A-frames, and other top hamper are particularly susceptible.



Figure 3816. Deck ice.

RESTRICTED VISIBILITY

3817. Fog

Fog is a cloud whose base is at the surface of the Earth, and is composed of droplets of water or ice crystals (ice fog) formed by condensation or crystallization of water vapor in the air.

Radiation fog forms over low-lying land on clear, calm nights. As the land radiates heat and becomes cooler, it cools the air immediately above the surface. This causes a temperature inversion to form, the temperature increasing with height. If the air is cooled to its dew point, fog forms. Often, cooler and more dense air drains down surrounding slopes to heighten the effect. Radiation fog is often quite shallow, and is usually densest at the surface. After sunrise the fog may “lift” and gradually dissipate, usually being entirely gone by noon. At sea the temperature of the water undergoes little change between day and night, and so radiation fog is seldom encountered more than 10 miles from shore.

Advection fog forms when warm, moist air blows over a colder surface and is cooled below its dew point. It is most commonly encountered at sea, may be quite dense, and often persists over relatively long periods. Advection fog is common over cold ocean currents. If the wind is strong enough to thoroughly mix the air, condensation may take place at some distance above the surface of the Earth, forming low stratus clouds rather than fog.

Off the coast of California, seasonal winds create an offshore current which displaces the warm surface water, causing an upwelling of colder water. Moist Pacific air is

transported along the coast in the same wind system and is cooled by the relatively cold water. Advection fog results. In the coastal valleys, fog is sometimes formed when moist air blown inland during the afternoon is cooled by radiation during the night.

When very cold air moves over warmer water, wisps of visible water vapor may rise from the surface as the water “steams.” In extreme cases this **frost smoke**, or **Arctic sea smoke**, may rise to a height of several hundred feet, the portion near the surface constituting a dense fog which obscures the horizon and surface objects, but usually leaves the sky relatively clear.

Haze consists of fine dust or salt particles in the air too small to be individually apparent, but in sufficient number might reduce horizontal visibility and cast a bluish or yellowish veil over the landscape, subduing its colors and making objects appear indistinct. This is sometimes called dry haze to distinguish it from damp haze, which consists of small water droplets or moist particles in the air, smaller and more scattered than light fog. In international meteorological practice, the term “haze” is used to refer to a condition of atmospheric obscurity caused by dust and smoke.

Mist is synonymous with drizzle in the United States but is often considered as intermediate between haze and fog in its properties. Heavy mist can reduce visibility to a mile or less.

A mixture of smoke and fog is called **smog**. Normally it is not a problem in navigation except in severe cases accompanied by an offshore wind from the source, when it may reduce visibility to 2-4 miles.

ATMOSPHERIC EFFECTS ON LIGHT RAYS

3818. Mirage

Light is refracted as it passes through the atmosphere. When refraction is normal, objects appear slightly elevated, and the visible horizon is farther from the observer than it otherwise would be. Since the effects are uniformly progressive, they are not apparent to the observer. When refraction is not normal, some form of mirage may occur. A **mirage** is an optical phenomenon in which objects appear distorted, displaced (raised or lowered), magnified, multiplied, or inverted due to varying atmospheric refraction which occurs when a layer of air near the Earth's surface differs greatly in density from surrounding air. This may occur when there is a rapid and sometimes irregular change of temperature or humidity with height. See Figure 3818a.

If there is a temperature inversion (increase of temperature with height), particularly if accompanied by a rapid decrease in humidity, the refraction is greater than normal. Objects appear elevated, and the visible horizon is farther away. Objects which are normally below the horizon become visible. This is called **looming**. If the upper portion



Figure 3818a. Distorted image of the moon rising.

of an object is raised much more than the bottom part, the object appears taller than usual, an effect called **towering**. If the lower part of an object is raised more than the upper part,

the object appears shorter, an effect called **stooping**. When the refraction is greater than normal, a superior mirage may occur. An inverted image is seen above the object, and sometimes an erect image appears over the inverted one, with the bases of the two images touching. Greater than normal refraction usually occurs when the water is much colder than the air above it.

If the temperature decrease with height is much greater than normal, refraction is less than normal, or may even cause bending in the opposite direction. Objects appear lower than normal, and the visible horizon is closer to the observer. This is called **sinking**. Towering or stooping may also occur if conditions are suitable. When the refraction is reversed, an inferior mirage may occur. A ship or an island appears to be floating in the air above a shimmering horizon, possibly with an inverted image beneath it. Conditions suitable to the formation of an inferior mirage occur when the surface is much warmer than the air above it. This usually requires a heated landmass, and therefore is more common near the coast than at sea.

When refraction is not uniformly progressive, objects may appear distorted, taking an almost endless variety of shapes. The Sun, when near the horizon, is one of the objects most noticeably affected. A **fata morgana** is a complex mirage characterized by marked distortion, generally in the vertical. It may cause objects to appear towering, magnified, and at times even multiplied. See Figure 3818b.



Figure 3818b. A *fata morgana* captured from South Pole Station, Antarctica.

3819. Sky Coloring

White light is composed of light of all colors. Color is related to wavelength, with the visible spectrum varying from about 400 to 700nanometers. The characteristics of each color are related to its wavelength (or frequency). The shorter the wavelength, the greater the amount of bending when light is refracted. It is this principle that permits the separation of light from celestial bodies into a spectrum

ranging from red, through orange, yellow, green, and blue, to violet, with infrared being slightly outside the visible range at one end and ultraviolet being slightly outside the visible range at the other end. Light of shorter wavelengths is scattered and diffracted more than that of longer wavelengths.

Light from the Sun and Moon is white, containing all colors. As it enters the Earth's atmosphere, a certain amount of it is scattered. The blue and violet, being of shorter wavelength than other colors, are scattered most. Most of the violet light is absorbed in the atmosphere. Thus, the scattered blue light is most apparent, and the sky appears blue. At great heights, above most of the atmosphere, it appears black.

When the Sun is near the horizon, its light passes through more of the atmosphere than when higher in the sky, resulting in greater scattering and absorption of blue and green light, so that a larger percentage of the red and orange light penetrates to the observer. For this reason the Sun and Moon appear redder at this time, and when this light falls upon clouds, they appear colored. This accounts for the colors at sunset and sunrise. As the setting Sun approaches the horizon, the sunset colors first appear as faint tints of yellow and orange. As the Sun continues to set, the colors deepen. Contrasts occur, due principally to differences in heights of clouds. As the Sun sets, the clouds become a deeper red, first the lower clouds and then the higher ones, and finally they fade to a gray.

When there is a large quantity of smoke, dust, or other material in the sky, unusual effects may be observed. If the material in the atmosphere is of suitable substance and quantity to absorb the longer wavelength red, orange, and yellow light, the sky may have a greenish tint, and even the Sun or Moon may appear green. If the green light, too, is absorbed, the Sun or Moon may appear blue. A green Moon or blue Moon is most likely to occur when the Sun is slightly below the horizon and the longer wavelength light from the Sun is absorbed, resulting in green or blue light being cast upon the atmosphere in front of the Moon. The effect is most apparent if the Moon is on the same side of the sky as the Sun.

3820. Rainbows

The **rainbow**, that familiar arc of concentric colored bands seen when the Sun shines on rain, mist, spray, etc., is caused by refraction, internal reflection, and diffraction of sunlight by the drops of water. The center of the arc is a point 180° from the Sun, in the direction of a line from the Sun passing through the observer. The radius of the brightest rainbow is 42° . The colors are visible because of the difference in the amount of refraction of the different colors making up white light, the light being spread out to form a spectrum. Red is on the outer side and blue and violet on the inner side, with orange, yellow, and green between, in that order from red.

Sometimes a secondary rainbow is seen outside the primary one, at a radius of about 50° . The order of colors of this rainbow is reversed. Very rarely, a third can be seen. On rare occasions a faint rainbow is seen on the same side as the Sun. The radius of this rainbow and the order of colors are the same as those of the primary rainbow.



Figure 3820. A fogbow.

A similar arc formed by light from the Moon (a lunar rainbow) is called a **Moonbow**. The colors are usually very faint. A faint, white arc of about 39° radius is occasionally seen in fog opposite the Sun. This is called a **fogbow**. See Figure 3820.

3821. Halos

Refraction, or a combination of refraction and reflection, of light by ice crystals in the atmosphere may cause a **halo** to appear. The most common form is a ring of light of radius 22° or 46° with the Sun or Moon at the center. Cirrostratus clouds are a common source of atmospheric ice crystals. Occasionally a faint, white circle with a radius of 90° appears around the Sun. This is called a **Hevelian halo**. It is probably caused by refraction and internal reflection of the Sun's light by bipyramidal ice crystals. A halo formed by refraction is usually faintly colored like a rainbow, with red nearest the celestial body and blue farthest from it.

A brilliant rainbow-colored arc, of about a quarter of a circle with its center at the zenith and the bottom of the arc about 46° above the Sun, is called a **circumzenithal arc**. Red is on the outside of the arc, nearest the Sun. It is produced by the refraction and dispersion of the Sun's light striking the top of prismatic ice crystals in the atmosphere and may be so brilliant as to be mistaken for an unusually bright rainbow. A similar arc formed 46° below the Sun, with red on the upper side, is called a **circumhorizontal arc**. Any arc tangent to a **heliocentric halo** (one surrounding the Sun) is called a **tangent arc**. As the Sun increases

in elevation, such arcs tangent to the halo of 22° gradually bend their ends toward each other. If they meet, the elongated curve enclosing the circular halo is called a **circumscribed halo**. The inner edge is red.

A halo consisting of a faint, white circle through the Sun and parallel to the horizon is called a **parhelic circle**. A similar one through the Moon is called a **paraselenic circle**. They are produced by reflection of Sunlight or Moonlight from vertical faces of ice crystals.

A **parhelion** (plural: parhelia) is a form of halo consisting of an image of the Sun at the same altitude and some distance from it, usually 22° , but occasionally 46° . A similar phenomenon occurring at an angular distance of 120° (sometimes 90° or 140°) from the Sun is called a **paranthe-lion**. One at an angular distance of 180° , a rare occurrence, is called an **anthelion**, although this term is also used to refer to a luminous, colored ring or glory sometimes seen around the shadow of one's head on a cloud or fog bank. A parhelion is popularly called a mock Sun or Sun dog. Similar phenomena in relation to the Moon are called **paraselene** (popularly a mock Moon or Moon dog), **paran-tiselene**, and **antiselene**. The term parhelion should not be confused with perihelion, the orbital point nearest the Sun when the Sun is the center of attraction.

A Sun pillar is a glittering shaft of white or reddish light occasionally seen extending above and below the Sun, usually when the Sun is near the horizon. A phenomenon similar to a **Sun pillar**, but observed in connection with the Moon, is called a **Moon pillar**. A rare form of halo in which horizontal and vertical shafts of light intersect at the Sun is called a **Sun cross**. It is probably due to the simultaneous occurrence of a Sun pillar and a parhelic circle. A similar phenomenon around the Moon is called a **Moon cross**.

See Figure 3821 for a depiction of many of these halo phenomena.

3822. Corona

When the Sun or Moon is seen through altostratus clouds, its outline is indistinct, and it appears surrounded by a glow of light called a **corona**. This is somewhat similar in appearance to, but quite distinct in cause from, the corona seen around the Sun during a solar eclipse. When the effect is due to clouds, the glow may be accompanied by one or more rainbow-colored rings of small radii, with the celestial body at the center. These can be distinguished from a halo by their much smaller radii and also by the fact that the order of the colors is reversed, red being on the inside, nearest the body, in the case of the halo, and on the outside, away from the body, in the case of the corona.

A corona is caused by diffraction of light by tiny droplets of water. The radius of a corona is inversely proportional to the size of the water droplets. A large corona indicates small droplets. If a corona decreases in size, the water droplets are becoming larger and the air more humid. This may be an indication of an approaching rainstorm. The



Figure 3821. From top to bottom: Circumzenithal arc, supralateral arc, Parry arc, tangential arc, 22 degree halo, parhelic circle, and sun dogs on right and left intersection of 22 degree halo and parhelic circle. Image courtesy of NOAA.

glow portion of a corona is called an **aureole**.

3823. The Green Flash

As light from the Sun passes through the atmosphere, it is refracted. Since the amount of bending is slightly different for each color, separate images of the Sun are formed in each color of the spectrum. The effect is similar to that of imperfect color printing, in which the various colors are slightly out of register. However, the difference is so slight that the effect is not usually noticeable. At the horizon, where refraction is at its maximum, the greatest difference, which occurs between violet at one end of the spectrum and red at the other, is about 10 seconds of arc. At latitudes of the United States, about 0.7 seconds of time is needed for the Sun to change altitude by this amount when it is near the horizon. The red image, being bent least by refraction, is first to set and last to rise. The shorter wave colors blue and violet are scattered most by the atmosphere, giving it its characteristic blue color. Thus, as the Sun sets, the green image may be the last of the colored images to drop out of sight. If the red, orange, and yellow images are below the horizon, and the blue and violet light is scattered and absorbed, the upper rim of the green image is the only part seen, and the Sun appears green. This is the **green flash**. The shade of green varies, and

occasionally the blue image is seen, either separately or following the green flash (at sunset). On rare occasions the violet image is also seen. These colors may also be seen at sunrise, but in reverse order. They are occasionally seen when the Sun disappears behind a cloud or other obstruction. See Figure 3823.

The phenomenon is not observed at each sunrise or sunset, but under suitable conditions is far more common than generally supposed. Conditions favorable to observation of the green flash are a sharp horizon, clear atmosphere, a temperature inversion, and a very attentive observer. Since these conditions are more frequently met when the horizon is formed by the sea than by land, the phenomenon is more common at sea. With a sharp sea horizon and clear atmosphere, an attentive observer may see the green flash at as many as 50 percent of sunsets and sunrises, although a telescope may be needed for some of the observations.

Durations of the green flash (including the time of blue and violet flashes) of as long as 10 seconds have been reported; such lengths are rare and most commonly occur at higher latitudes. Usually a green flash lasts for a period of about 1/2 to 2 1/2 seconds, with about 1 1/4 seconds being average. This variability is probably due primarily to changes in the index of refraction of the air near the horizon.



Figure 3823. Green Flash.

Under favorable conditions, a momentary green flash has been observed at the setting of Venus and Jupiter. A telescope improves the chances of seeing such a flash from a planet, but is not a necessity.

3824. Crepuscular Rays

Crepuscular rays are beams of light from the Sun

passing through openings in the clouds, and made visible by illumination of dust in the atmosphere along their paths. Actually, the rays are virtually parallel, but because of perspective, they appear to diverge. Those appearing to extend downward are popularly called **backstays of the Sun**, or the **Sun drawing water**. Those extending upward and across the sky, appearing to converge toward a point 180° from the Sun, are called **antirepuscular rays**.

THE ATMOSPHERE AND RADIO WAVES

3825. Atmospheric Electricity

Radio waves traveling through the atmosphere exhibit many of the properties of light, being refracted, reflected, diffracted, and scattered. These effects are discussed in greater detail in Chapter 21, Radio Waves.

Various conditions induce the formation of electrical charges in the atmosphere, the most common of which involves atmospheric convection. Thunderstorms contain updrafts where ice particles of various size and shape collide in the presence of supercooled water. This process typically results in the stratification of layers of negative and positive charge within the cloud, producing large electric fields. As enormous electrical stresses build up within thunderclouds,

they induce a region of opposing charge on the Earth's surface. These electric fields grow until they surpass a certain minimum threshold, resulting in a phenomenon termed lightning.

Lightning is the discharge of electricity from one part of a thundercloud to another, between different clouds, or between a cloud and the Earth or a terrestrial object. Over a billion lightning flashes occur each year globally (~40 flashes every second). Most lightning is **intra-cloud (IC; ~90%)**, and most **cloud-to-ground (CG) lightning** lowers negative charge from within the cloud to the ground (~90%). Positive CG lightning lowers positive charge from within the cloud to the ground, and objects taller than their surroundings also can trigger upward lightning flashes of positive or negative

polarity.

Lightning generates **electromagnetic pulses** that propagate as radio waves in all directions. CG lightning generally exhibits strong current in long vertical channels, emitting most efficiently in the low-frequency (LF) to very-low frequency (VLF) range. IC lightning channels typically are more horizontal with weaker current, emitting most efficiently in the high-frequency (HF) to very-high frequency (VHF) range. Ground-based lightning detection networks geolocate lightning using the signal arrival angle and/or arrival times at multiple sensors. Satellite sensors also detect lightning, but they observe the optical lightning emissions at cloud top.

Strong VLF signals propagate long distances (1000's of km), so long-range VLF networks (3-30 kHz) can detect high-current lightning globally with fewer than 100 sensors (mostly CG detection). Alternatively, local VHF networks (50-200 MHz) detect emissions associated with electrical breakdown during lightning channel formation and re-illumination. The VHF networks provide detailed 3-D lightning mapping, but are spatially limited by the line-of-site propagation of VHF radio waves. Some networks employ a blended approach (e.g., 1 Hz to 12 MHz) to provide a degree of global CG lightning detection with better performance (i.e., IC detection) in regions with more sensors. Since higher frequency signals attenuate more quickly than lower frequency signals, regardless of the technology, IC lightning observations are limited in regions lacking sensors (e.g., the deep ocean).

Thunder, the noise that accompanies lightning, is caused by the heating, ionizing, and rapid expansion of the air by lightning, sending out a compression wave along the lightning channel. Thunder audibility is influenced by the temperature, humidity, wind velocity, wind shear, temperature inversions, terrain features, and clouds. When thunder is heard, lightning is present, whether or not visible to the observer. Thunder is seldom heard beyond 10 miles (16 km), so if thunder is audible, lightning is close enough to strike.

The sound of distant thunder has a characteristic low-pitched rumbling sound. **Pitch**, the degree of highness or lowness of a sound, is due to strong absorption and scattering of high-frequency components of the original sound waves. The rumbling results from the fact that sound waves are emitted from different locations along the lightning channel, which lie at varying distances from the observer. The longer the lightning channels, the longer the thunder. The elapsed time between the lightning and thunder is due to the difference in travel time of light and sound. Since the former is comparatively instantaneous, and the speed of sound is about 1,117 feet per second, the approximate distance in nautical miles is equal to the elapsed time in seconds, divided by 5.5.

Lightning occurs in fairly well-documented regions and seasons, so knowledge of local weather patterns can help mitigate its threat to humans. Nearly 70 percent of all

lightning occurs in the tropical latitude band between 35° N and 35° S. Globally, 85 to 90 percent of lightning occurs over land because solar radiation heats land quicker, causing convection (thunderstorms) to be taller and stronger. The signs of lightning almost always are present before it strikes, whether it is as direct as thunder or as obscure as a growing cumulus cloud on the horizon. Lightning trends are indicative of thunderstorm intensity, so rapidly updating lightning observations provides valuable insights into thunderstorm evolution. IC lightning better indicates thunderstorm intensity since it relates more closely to updraft evolution than does CG lightning. Other manifestations of atmospheric electricity also are known to occur. For example, **St. Elmo's fire** is a luminous discharge of electricity from pointed objects such as the masts and antennas of ships, lightning rods, steeples, mountain tops, blades of grass, , etc., when there is a considerable difference in the electrical charge between the object and the air. It appears most frequently during thunderstorms. An object from which St. Elmo's fire emanates is in danger of being struck by lightning because this discharge may be the initial phase of a CG lightning flash. Throughout history those who have not understood St. Elmo's fire have regarded it with superstitious awe, considering it a supernatural manifestation. This view is reflected in the name *corposant* (from "corpo santo," meaning "body of a saint") sometimes given this phenomenon.

See Figure 3825a for a depiction of flash density across the planet over an 18 year period of time.

The **Aurora (Northern Lights)** and **Aurora Australis (Southern Lights)** are the result of electrically charged particles colliding with the upper reaches of Earth's atmosphere. Electrons, primarily responsible for the visible aurora, are energized through acceleration processes in the magnetosphere. They follow the magnetic field of Earth down to the Polar Regions where they collide with oxygen and nitrogen atoms and molecules in Earth's upper atmosphere. In these collisions, the electrons transfer their energy to the atmosphere thus exciting the atoms and molecules to higher energy states. When they relax down to lower energy states, they release their energy in the form of light. This is similar to how a neon light works. The aurora typically forms 80 to 500 km above Earth's surface.

Earth's magnetic field guides the electrons such that the aurora forms two ovals approximately centered at the magnetic poles. During major geomagnetic storms these ovals expand away from the poles such that aurora can be seen over much of the northern United States. Often the auroral forms consist of tall rays that look much like a curtain or folds of cloth. During the evening, these rays can form arcs that stretch from horizon to horizon. Late in the evening, near midnight, the arcs often begin to twist and sway, just as if a wind were blowing on the curtains of light. At some point, the arcs may expand to fill the whole sky, moving rapidly and becoming very bright. Then in the early morning the auroral forms can take on a more cloud-like

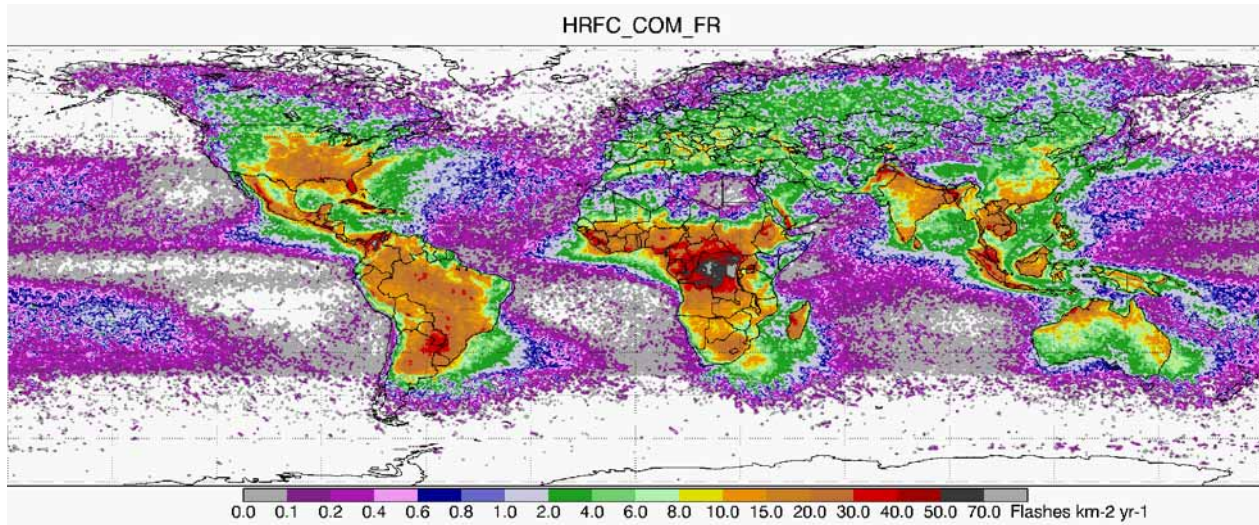

Figure 3825a. LIS/OTD 0.5 Degree High Resolution Full Climatology (HRFC) Annual Flash Density Map (1995-05-04 to 2013-12-31) available at <https://dx.doi.org/10.5067/LIS/LIS-OTD/DATA302>

appearance. These diffuse patches often blink on and off repeatedly for hours, then they disappear as the sun rises in the east.

When space weather activity increases and more frequent and larger storms and substorms occur, the aurora extends equator-ward. During large events, the aurora can

be observed as far south as the U.S., Europe, and Asia. During very large events, the aurora can be observed even farther from the poles. Of course, to observe the aurora, the skies must be clear and free of clouds. It must also be dark so during the summer months at auroral latitudes, the mid-night sun prevents auroral observations. See Figure 3825b.



Figure 3825b. Aurora (Northern Lights) video capture. Image courtesy of NOAA.

The best place to observe the aurora is under an oval-shaped region between the north and south latitudes of

about 60 and 75 degrees. At these polar latitudes, the aurora can be observed more than half of the nights of a given year

as long as its dark.

More information, including a 30-minute aurora forecast for both the northern and southern hemispheres and

tips for viewing the aurora can be found at the Space Weather Prediction Center's website.

WEATHER ANALYSIS AND FORECASTING

3826. Forecasting Weather

The prediction of weather at some time in the future is based upon an understanding of weather processes and observations of present conditions. Thus, when there is a certain sequence of cloud types, rain usually can be expected to follow. If the sky is cloudless, more heat will be received from the Sun by day, and more heat will be radiated outward from the warm Earth by night than if the sky is overcast. If the wind is from a direction that transports warm, moist air over a colder surface, fog can be expected. A falling barometer indicates the approach of a "low," probably accompanied by stormy weather. Thus, before meteorology passed from an "art" to "science," many individuals learned to interpret certain atmospheric phenomena in terms of future weather, and to make reasonably accurate forecasts for short periods into the future.

With the establishment of weather observation stations, continuous and accurate weather information became available. As observations expanded and communication techniques improved, knowledge of simultaneous conditions over wider areas became available. This made possible the collection of "synoptic" reports at civilian and military forecast centers.

Individual observations are made at stations on shore and aboard vessels at sea. Observations aboard merchant ships at sea are made and transmitted on a voluntary and cooperative basis. The various national meteorological services supply shipmasters with blank forms, printed instructions, reporting software, and other materials essential to the making, recording, and interpreting of observations. Any shipmaster can render an extremely valuable service by reporting weather conditions for all usual and unusual or non-normal weather occurrences.

Symbols and numbers are used to indicate on a synoptic chart, popularly called a weather map, the conditions at each observation station. **Isobars** are drawn through lines of equal atmospheric pressure, fronts are located and symbolically marked, areas of precipitation and fog are indicated, etc. For examples of how fronts and other symbols are used on weather charts, see the National Weather Service link in Figure 3826.

Ordinarily, weather maps for surface observations are prepared every 6 (sometimes 3) hours. In addition, synoptic charts for selected heights are prepared every 12 (sometimes 6) hours. Knowledge of conditions aloft is of value in establishing the three-dimensional structure and motion of the atmosphere as input to the forecast.

With the advent of the computer, highly sophisticated



Figure 3826. Ocean Prediction Center terminology and weather symbols:

https://www.opc.ncep.noaa.gov/product_description/keyterm.htm

numerical models have been developed to analyze and forecast weather patterns. The civil and military weather centers prepare and disseminate vast numbers of weather charts (analyses and prognoses) daily to assist local forecasters in their efforts to provide users with accurate weather forecasts. The accuracy of the forecast decreases with the length of the forecast period. A 12-hour forecast is likely to be more reliable than a 24-hour forecast. Long-term forecasts for 2 weeks or a month in advance are limited to general statements. For example, a prediction may be made about which areas will have temperatures above or below normal and how precipitation will compare with normal, but no attempt is made to state that rainfall will occur at a certain time and place.

Forecasts are issued for various areas. The national meteorological services of most maritime nations, including the United States, issue forecasts for ocean areas and warnings of approaching storms. The forecasting efforts of all nations are coordinated by the **World Meteorological Organization**.

3827. Weather Dissemination

Timely access to weather information is important to ensure the safety and efficiency of activities at sea. Weather forecasting agencies, both public and private, use the latest technology to deliver a broad range of climate, water, and weather information in graphical and text form.

The **Global Maritime Distress and Safety System (GMDSS)** was established to provide more effective and efficient emergency and safety communications, and to disseminate Maritime Safety Information (MSI) to all ships

on the world's oceans regardless of location or atmospheric conditions. MSI includes navigational warnings, meteorological warnings and forecasts, and other urgent safety-related information. GMDSS goals are defined in the International Convention for the **Safety Of Life At Sea (SOLAS)**, and affect vessels over 300 gross tons and passenger vessels of any size. The U.S. National Weather Service participates directly in the GMDSS by preparing meteorological forecasts and warnings for broadcast via NAVTEX and SafetyNET.

Disseminating weather information is carried out in a number of ways; some are part of GMDSS and others are not. Weather forecasts and warnings are available by various means including TV, radio (AM/FM and specifically FM 162.400MHz to 164.550MHz), and satellite broadcasts (SBN/NOAAPORT, NWWS and EMWIN), telephone (Weather Apps or call-in to local Weather Forecast Offices), and the Internet (Figure 3827a and other commercial weather providers and software programs).



Figure 3827a. National Weather Service website:
<http://www.weather.gov>

Visual storm warnings are displayed in various ports, and storm warnings are broadcast by radio. Worldwide marine meteorological and oceanographic forecasting and dissemination responsibilities via Inmarsat-C SafetyNET have been divided into MetAreas by the World Meteorological Organization (WMO)- Intergovernmental Oceanographic Commission (IOC) Joint Technical Commission for Oceanography and Marine Meteorology (JCOMM). The forecasting responsibilities for each MetArea are handled by the National Meteorological Services appointed as Issuing Services within the framework of the WMO Marine Broadcast System for the GMDSS. More information about which forecasting agency has forecasting responsibilities for each Metarea can be found in Figure 3827b.

NAVTEX Broadcasts

NAVTEX is an international automated medium frequency (518 kHz) direct-printing service for delivery of navigational and meteorological warnings and forecasts, as well as urgent marine safety information to ships. It was developed as an automated means of receiving this information aboard ships at sea within approximately 200 nautical miles of shore. NAVTEX stations in the U.S. are operated by the U.S. Coast Guard. There are no user fees as-



Figure 3827b. WMO Marine broadcast system for GMDSS website: <http://weather.gmdss.org/metareas.html>



Figure 3827c. National Weather Service NAVTEX marine weather forecast broadcasts:
<https://www.nws.noaa.gov/om/marine/navtex.htm>

sociated with receiving NAVTEX broadcasts. Information about marine weather forecasts broadcast through NAVTEX can be found at the link provided in Figure 3827c. Additional information is also available on individual Met Area webpages.

Inmarsat Broadcasts

Inmarsat-C SafetyNET is an internationally adopted, automated satellite system for promulgating weather forecasts and warnings, marine navigational warnings, and other safety-related information to all types of vessels. There are no user fees associated with receiving SafetyNET broadcasts. The National Weather Service prepares high-seas forecasts and warnings for broadcast via SafetyNET for each of the three ocean areas they are responsible for covering four times daily. Information about marine weather forecasts broadcast through Inmarsat-C SafetyNET can be found at the link in Figure 3827d.

Radiofax Broadcasts

Radiofax, also known as HF FAX, radiofacsimile or weatherfax, is a means of broadcasting graphic weather maps and other graphic images via HF radio. HF radiofax



Figure 3827d. Inmarsat marine weather forecast broadcasts:

<https://www.nws.noaa.gov/om/marine/inmarsat.htm>

is also known as WEFAX, although this term is generally used to refer to the reception of weather charts and imagery via satellite. Maps are received using a dedicated radiofax receiver or a single sideband shortwave receiver connected to an external facsimile recorder or PC equipped with a radiofax interface and application software.

The earliest broadcasts of weather maps via radiofacsimile appear to have been made in 1926 by American

inventor Charles Francis Jenkins in a demonstration to the Navy. The U.S. Weather Bureau conducted further tests of its applicability in 1930. While radiofacsimile has been used for everything from transmitting newspapers to wanted posters in the past, the broadcasting of marine charts is today the primary application.

The National Weather Service radiofax program prepares high seas weather maps for broadcast via four U.S. Coast Guard stations (Boston, New Orleans, Pt. Reyes, and Kodiak) and one Department of Defense transmitter site (Honolulu). These broadcasts are prepared by the **Ocean Prediction Center, National Hurricane Center, Honolulu Forecast Office, and Anchorage Forecast Office**. Limited satellite imagery, sea surface temperature maps, and text forecasts are also available at their individual websites.

All National Weather Service radiofax products are available via the Internet (HTTP, FTP or Email). Although available, internet access is not feasible for most vessels. Broadcasts of graphic marine forecasts via HF radiofax remains among the most valued of NWS marine services. An example of radiofax surface analysis chart is shown in Figure 3827e.

More information about marine weather radiofax broadcasts can be found at the link in Figure 3427f.

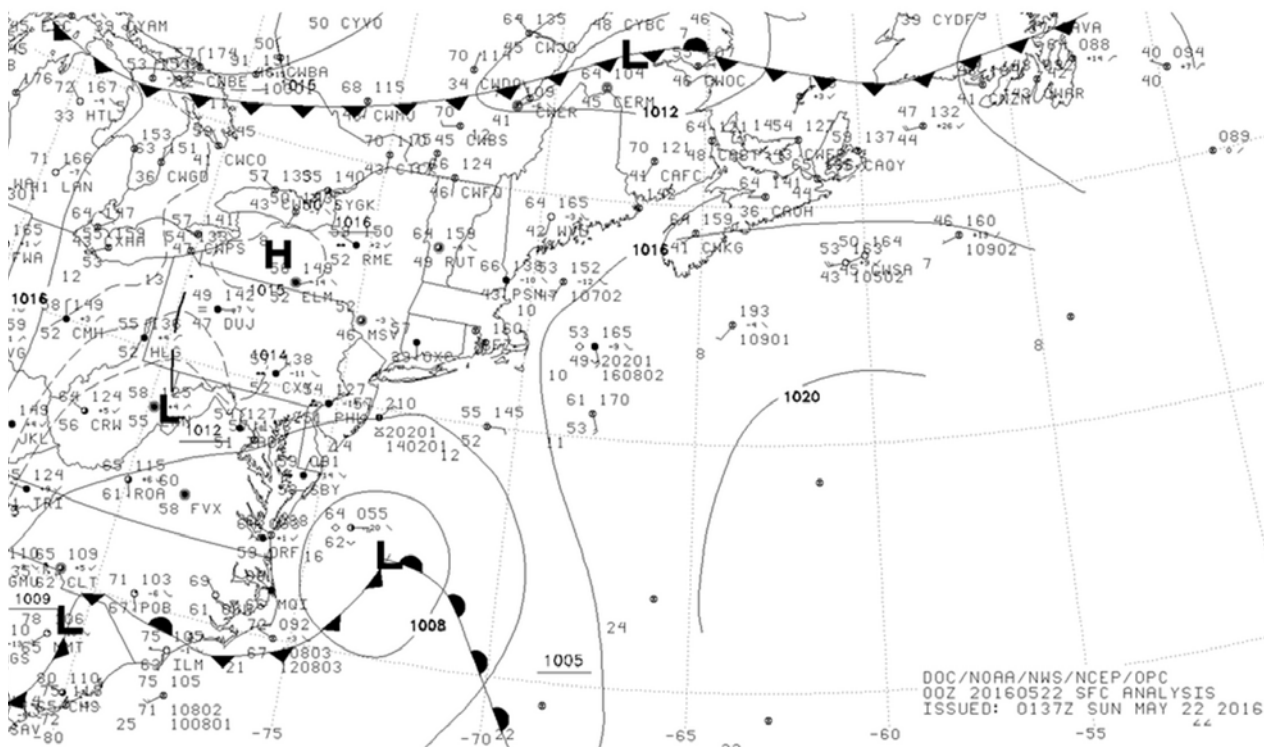

Figure 3827e. National Weather Service radiofax surface analysis example.

Weather Products via the Internet

With the advent of wireless technologies, information

updates are almost seamless to keep mariners current on changing environmental conditions. These technologies include the dissemination and receipt of nautical charts,



Figure 3827f. Information on marine weather radiofax broadcasts:

<https://www.nws.noaa.gov/om/marine/radiofax.htm>

ocean and weather information using satellite telephones, the Internet and various computer or commercial applications. The reduction in the price for satellite-based internet access have enabled vessels to access large graphic files produced by various weather forecasting agencies, including the National Weather Service, online. Additional websites to the ones already presented in this chapter that a mariner may find useful are listed below.

Information on dissemination of marine weather information may be found in *NGA Pub. 117, Radio Navigational Aids* and the *International Maritime Organization* publication, *Master Plan of Shore Based Facilities for the GMDSS*;

Information on day and night visual storm warnings is given in the various volumes of *Sailing Directions*, both *En-routes* and *Planning Guides*.

Then National Weather Service - Worldwide Marine Radiofacsimile Broadcast Schedule (dated September 9, 2016) can be accessed via the link in Figure 3827g.



Figure 3827g. Worldwide Marine Radiofacsimile Broadcast Schedule:

<https://www.nws.noaa.gov/os/marine/rfax.pdf>

Meteorological and oceanographic information, including weather forecasts produced by the United States can be found in the links contained in Figure 3827h, Figure



Figure 3827h. Information on weather forecasts produced by the United States:

<https://www.nws.noaa.gov/om/marine/home.htm>



Figure 3827i. Coastal and Great Lakes forecast:

<https://www.nws.noaa.gov/om/marine/zone/usamz.htm>



Figure 3827j. Fleet Numerical Meteorology and Oceanography Center:

<https://www.usno.navy.mil/FNMOC>

For additional port-area tides and currents information see the link in Figure 3827k.

For additional meteorological information derived from data buoy collectors see Figure 3827l.



Figure 3827k. NOAA port information:
<https://tidesandcurrents.noaa.gov/ports.html>

3828. Interpreting Weather

The factors which determine weather are numerous and varied. Ever-increasing knowledge regarding them makes possible a continually improving weather service. However, the ability to forecast is acquired through study and long practice, and therefore the services of a trained meteorologist should be utilized whenever available.

The value of a forecast is increased if one has access to the information upon which it is based, and understands the principles and processes involved. It is sometimes as important to know the various types of weather which may be experienced as it is to know which of several possibilities is most likely to occur.



Figure 3827l. National Data Buoy Center:
<https://www.ndbc.noaa.gov/>

At sea, reporting stations are unevenly distributed, sometimes leaving relatively large areas with incomplete reports, or none at all. Under these conditions, the locations of highs, lows, fronts, etc., are imperfectly known, and their very existence may even be in doubt. At such times mariners who can interpret the observations made from their own vessel may be able to predict weather for the next several hours more reliably than a trained meteorologist ashore.

3829. References

© Figures 3808, 3810a, 3814a & 3814b are provided courtesy of University Corporation for Atmospheric Research (UCAR), COMINT Program, Boulder, CO 80301.

CHAPTER 39

TROPICAL CYCLONES

DESCRIPTION AND CAUSES

3900. Introduction

Tropical cyclone is a general term for a cyclone originating over the tropical oceans, although technical definitions differ across the globe. Over the North Atlantic, and eastern North Pacific Oceans, for example, a tropical cyclone is defined by the National Hurricane Center (NHC) as “a warm-core non-frontal synoptic-scale cyclone, originating over tropical or subtropical waters, with organized deep convection and a closed surface wind circulation about a well-defined center.” Similar definitions are in use by the various global operational forecast centers.

For access to the *Glossary of NHC Terms* see the link provided in Figure 3900.



Figure 3900. Link to the *Glossary of NHC Terms*.
<https://www.nhc.noaa.gov/aboutgloss.shtml>

Once formed, a tropical cyclone is maintained by the extraction of heat energy from the ocean at high temperature and heat export at the low temperatures of the upper atmosphere. In this they differ from the extratropical cyclones of higher latitudes, which derive their energy from horizontal temperature contrasts in the atmosphere. As a result of their different energy sources, tropical cyclones tend to be more circularly symmetric than extratropical cyclones, tend to be smaller, and have their fiercest winds and rains located closer to the area of lowest pressure. Tropical cyclones are infrequent in comparison with middle- and high-latitude storms, but they have a record of destruction far exceeding that of any other type of storm. Because of their fury, and because they are predominantly oceanic, they merit special attention by mariners. The rapidity with which the weather can deteriorate with approach of the storm, and the violence of the fully developed tropical cyclone are difficult to imagine if they have not been experienced.

On his second voyage to the New World, Columbus

encountered a tropical storm. Although his vessels suffered no damage, this experience proved valuable during his fourth voyage when his ships were threatened by a fully developed hurricane. Columbus read the signs of an approaching storm from the appearance of a southeasterly swell, the direction of the high cirrus clouds, and the hazy appearance of the atmosphere. He directed his vessels to shelter. The commander of another group, who did not heed the signs, lost most of his ships and more than 500 men perished.

3901. Definitions

Tropical cyclones are classified by the intensity of their highest associated winds, usually measured by a 1-minute or a 10-minute average. The following terms apply in the North Atlantic and eastern North Pacific Oceans:

- (1) Tropical depression - a tropical cyclone in which the maximum sustained (1-minute mean) surface wind speed is 33 kts or less.
- (2) Tropical storm - a tropical cyclone in which the maximum sustained (1-minute mean) surface wind speed ranges from 34 to 63 kts.
- (3) Hurricane - a tropical cyclone in which the maximum sustained (1-minute mean) surface wind is 64 kts or more.
- (4) Major hurricane - a tropical cyclone in which the maximum sustained (1-minute mean) surface wind is 96 kts or more.

When cyclones no longer possess sufficient tropical characteristics to be considered a tropical cyclone, they may be referred to as “post tropical.” These cyclones may continue to produce heavy rains, high winds, and large seas. A remnant low is a post-tropical cyclone that no longer possesses the convective organization required of a tropical cyclone and has maximum sustained winds of less than 34 knots.

Other terms are used globally. In the western North Pacific, **typhoon** is synonymous with the Atlantic term hurricane, while **super typhoon** refers to a **tropical cyclone** with maximum sustained winds of 130 kts or more. In the Philippines, a typhoon is also known as a **bagyo**. In the North Indian Ocean, a tropical cyclone with winds of 34

knots or greater is called a **cyclonic storm**, while in the South Indian Ocean, a tropical cyclone with winds of 34 knots or greater is called a **cyclone**. A severe tropical cyclone originating in the Timor Sea and moving southwest and then southeast across the interior of northwestern Australia is called a **willy-willy**.

The term **tropical disturbance** refers to a discrete system of apparently organized convection, generally 100 to 300 miles in diameter, having a non-frontal migratory character, and must have maintained its identity for 24 hours or

more. These systems generally do not have strong winds or closed isobars (i.e., isobars that completely enclose the low). Tropical disturbances can develop into tropical cyclones.

3902. Areas of Occurrence

Tropical cyclones occur almost entirely in six distinct areas: the North Atlantic Ocean (including the Caribbean Sea and Gulf of Mexico), the eastern North Pacific (includ-

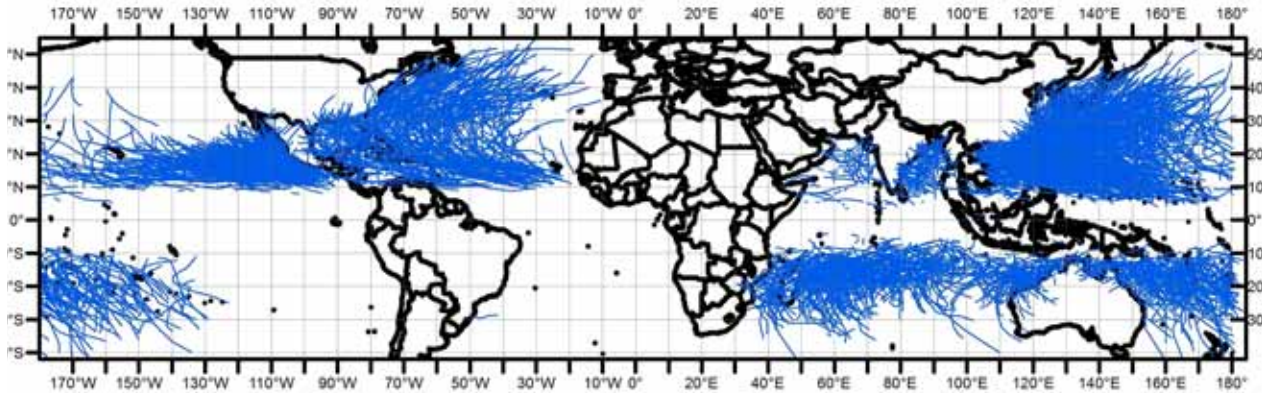

Figure 3902a. Tracks of all tropical cyclones with maximum 1-minute mean wind speed of 34 kts or greater during the period 1981-2010 (data sources National Hurricane Center, Central Pacific Hurricane Center, Joint Typhoon Warning Center; image credit Colorado State University).

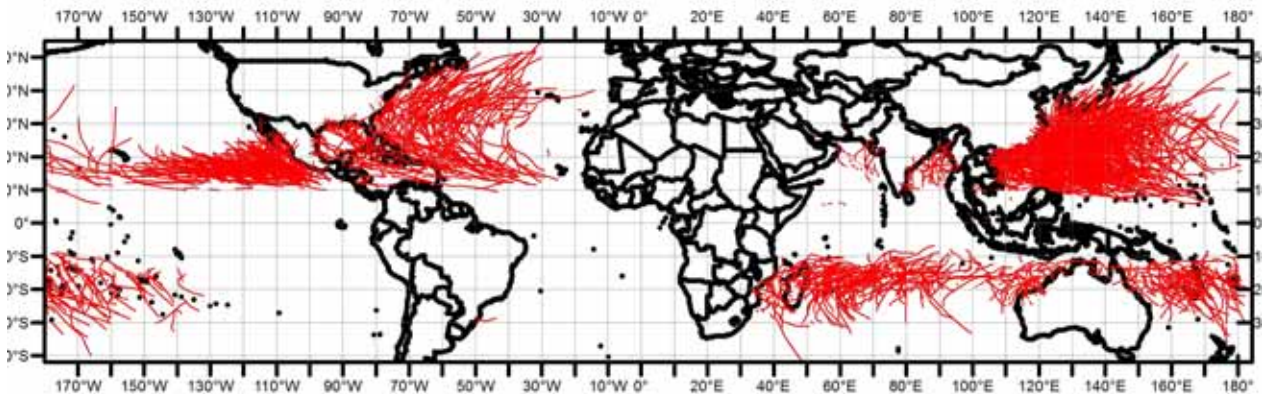

Figure 3902b. Tracks of all tropical cyclones with maximum 1-minute mean wind speed of 64 kts or greater during the period 1981-2010 (sources National Hurricane Center, Joint Typhoon Warning Center and Colorado State University).

ing the central North Pacific to the Date Line), the western North Pacific, the North Indian Ocean (including the Bay of Bengal and the Arabian Sea), the south Indian Ocean, and the Southwest Pacific/Australia area. The south Atlantic Ocean is nearly devoid of tropical cyclones, and none have been observed in the South Pacific east of 120°W. Figure 3902a shows the global tracks of all tropical cyclones of at least tropical storm strength during the period 1981-2010, while Figure 3902b shows the global track of all tropical

cyclones of hurricane strength during the same period.

3903. Origin, Season and Frequency

Table 3903 describes the frequency of formation for tropical cyclones of tropical storm and hurricane intensity in each of the six primary tropical cyclone basins worldwide. The general character of each basin's activity is described below.

North Atlantic: Tropical cyclones have formed in every month of the year; however, they are mostly a threat south of about 35°N from June through November, the official months of the Atlantic hurricane season. August, September, and October are the months of highest incidence. About 12 tropical storms form each season, and roughly 6 reach hurricane intensity. Early and late-season storms usually develop west of 50°W, although during August and September the spawning ground extends to the Cape Verde Islands. In the lower latitudes, tropical cyclones typically move westward or west-northwestward at speeds of less than 15 knots. After moving into the northern Caribbean Sea or near the Greater Antilles, they usually either move toward the Gulf of Mexico or recurve and accelerate northeastward in the North Atlantic. Some will recurve after reaching the Gulf of Mexico, while others will continue westward to a landfall in Texas, Mexico,

or central America.

Eastern North Pacific: The official season runs from May 15th through the end of November, although a storm can form in any month of the year. An average of 17 tropical cyclones forms annually in this basin, with about 9 typically reaching hurricane strength. The most intense storms are often the late-season ones; these can form close to the coast and relatively far to the south. Mid-season storms form anywhere in a wide band from the Mexican coast to the Hawaiian Islands. August and September are the months of highest incidence. Although eastern North Pacific storms are often smaller than their North Atlantic counterparts, they can be just as intense (and in fact the strongest tropical cyclone on record in the western hemisphere, 2015's Hurricane Patricia, formed in this basin).

Western North Pacific: More tropical cyclones form

AREA AND STAGE	JAN	FEB	MAR	APR	MAY	JUN	JUL	AUG	SEP	OCT	NOV	DEC	ANNUAL
NORTH ATLANTIC													
TROPICAL STORMS				0.1	0.1	0.6	1.0	3.2	4.1	2.1	0.7	0.1	12.1
HURRICANES						0.1	.05	1.6	2.6	1.2	0.5		6.4
EASTERN NORTH PACIFIC													
TROPICAL STORMS					0.7	1.9	3.5	4.3	3.7	2.2	0.3	0.1	16.6
HURRICANES					0.3	0.8	1.8	2.1	2.5	1.3	0.2		8.9
WESTERN NORTH PACIFIC													
TROPICAL STORMS	0.4	0.2	0.4	0.7	1.2	1.6	3.7	5.8	5.0	3.8	2.6	1.4	26.6
TYPHOONS	0.2		0.2	0.4	0.7	1.0	2.2	3.5	3.4	2.9	1.6	0.7	16.7
SOUTHWEST PACIFIC AND AUSTRALIAN AREA													
TROPICAL STORMS	3.5	3.8	3.2	1.7	0.3	0.1				0.2	0.5	2.2	15.6
HURRICANES	1.5	1.9	2.0	1.0	0.1						0.3	1.2	8.0
SOUTH INDIAN OCEAN													
TROPICAL STORMS	2.7	2.5	2.0	1.2	0.4	0.1	0.2	0.1	0.3	0.5	1.2	1.4	12.5
HURRICANES	1.5	1.5	1.3	0.7	0.2					0.1	0.6	0.6	6.6
NORTH INDIAN OCEAN													
TROPICAL STORMS	0.1	0.1		0.2	0.8	0.6	0.1		0.3	1.0	1.3	0.6	4.9
CYCLONES				0.1	0.4	0.1				0.1	0.6	0.2	1.6

Table 3903. Monthly and annual numbers of tropical cyclones formed for each major cyclone basin for the period 1981-2010. For all basins, tropical storm refers to systems with maximum 1-minute sustained winds of 34 kts or greater, and hurricane refers to systems with maximum 1-minute sustained winds of 64 kts or greater (sources National Hurricane Center, Joint Typhoon Warning Center and Colorado State University).

in the tropical western North Pacific than in any other global tropical cyclone basin. On average, more than 25 tropical storms develop annually, and about 17 reach hurricane (typhoon) strength. Western North Pacific typhoons are the largest and most intense tropical cyclones in the world. An average of five generate maximum winds over 130 knots annually, and cyclonic circulations of more than 600 miles in diameter are not uncommon. Most of these storms form east of the Philippines, and move across the Pacific toward the Philippines, Japan, and China; a few storms form in the South China Sea. The primary season extends from April through December, although off-season formations are more common in this area than in any other basin. The peak of the season is July through October, when nearly 70 percent of all typhoons develop. The basin features a noticeable seasonal shift in storms; July through September storms tend to move north of the Philippines and recurve, while early- and late-season typhoons typically take on a more westerly track through the Philippines before recurving. Because of

their relative high frequency, it is not uncommon for one tropical cyclone to be influenced by a nearby cyclone, an interaction that often produces very erratic tracks for both systems.

North Indian Ocean—Tropical cyclones develop in the Bay of Bengal and Arabian Sea during the spring and fall. Tropical cyclones in this area form between latitudes 8°N and 15°N, except from June through September, when the little activity that does occur is confined north of about 15°N. Although these storms are usually short-lived and weak, winds of 130 knots or more have been encountered. North Indian Ocean cyclones often develop as disturbances within the monsoon trough, which inhibits summertime development since the monsoon trough is usually over land during the monsoon season. However, the trough is sometimes displaced southward, and when this occurs storms will form over the monsoon-flooded plains of Bengal. On average, about five tropical storms form each year, with about two reaching hurricane strength. Within the basin, the

Bay of Bengal is the area of highest incidence. It is not unusual for a storm to move across southern India and re-intensify in the Arabian Sea, and this is particularly true during October and November, the months of highest incidence. It is also during this period that torrential rains from these storms, dumped over already rain-soaked areas, are most likely to cause disastrous floods.

South Indian Ocean—Over the waters west of 100°E to the east African coast, an average of 11 tropical storms form each season, with about 4 reaching hurricane intensity. The season is from December through March, although it is possible for a storm to form in any month. Tropical cyclones in this region usually form south of 10°S. The latitude of re-circulation usually migrates from about 20°S in January to around 15°S in April. After crossing 30°S, these storms sometimes become intense extratropical lows.

Southwest Pacific and Australian Area—These

tropical waters spawn an annual average of 15 tropical storms, of which 4 reach hurricane intensity. The main season extends from about December through April, although storms can form in any month. Activity is widespread in January and February, and it is in these months that tropical cyclones are most likely to affect Fiji, Samoa, and the other eastern islands. Tropical cyclones usually form in the waters from 105°E to 160°W, between 5° and 20°S. Storms affecting northern and western Australia often develop in the Timor or Arafura Sea, while those that affect the east coast form in the Coral Sea. These storms are often small, but can develop winds in excess of 130 knots. New Zealand is sometimes reached by decaying Coral Sea storms, and occasionally by an intense hurricane. In general, tropical cyclones in this region move southwestward and then recurve southeastward.

TROPICAL CYCLONE BASICS

3904. Formation

Tropical cyclones form from pre-existing disturbances that are typically convective cloud clusters associated with a low-level cyclonic vorticity maximum, such as a tropical wave (although tropical cyclones can also form from non-tropical precursor disturbances, such as old frontal boundaries or upper-level lows). Low-level vorticity maxima are also areas of low pressure at the surface, and due to the pressure gradient force, air will flow inward toward the low pressure area. As a result of the Coriolis force, the inward-flowing air is deflected to the right (left in the Southern Hemisphere) and this creates a counter-clockwise (clockwise in the Southern Hemisphere) circulation. The inflow of air produces low-level convergence that in turn results in rising motion and deep convection (showers and thunderstorms) near the area of lowest pressure. The tropical cyclone is essentially a heat engine, with the heat source being the underlying ocean. Water vapor from the ocean condenses in rising columns of air, releasing the latent heat of condensation. In these near-saturated air columns, which ultimately become the eyewall and rain bands of the cyclone, the latent heating is offset by adiabatic cooling. Unsaturated air sinks in the eye, and adiabatic warming of the subsiding air results, through hydrostatic balance, in a fall in central pressure and an intensification of the cyclonic circulation.

The development and intensification of a tropical cyclone requires an unstable air mass and a deep layer of moist air extending through the middle troposphere. Atmospheric instability is required to produce deep convection, which produces the latent heating. Although it had been previously thought that sea surface temperatures of at least 79-80 degrees Fahrenheit were a necessary condition, tropical cyclone formation has been observed over waters in the

low 70s. This implies that the vertical lapse rate, i.e., the change of temperature with height, can be large enough to provide the needed instability even over cooler waters. A deep layer of humid air is needed to prevent the development of cold downdrafts, which would result in low-level divergence that would disrupt the development process. An additional requirement is that the vertical wind shear, i.e., the change of the wind with height, be sufficiently low, say less than 15 to 20 kts from the surface to the upper troposphere. Strong shear would significantly tilt the developing vortex from the vertical and this loss of vertical coherence of the circulation prevents intensification. The environmental factors needed for tropical cyclone formation are met over much of the tropical oceanic regions, including the Atlantic, Caribbean Sea, Gulf of Mexico, the Northern Hemispheric Pacific, the waters around Australia, and both the Northern and Southern Hemispheric Indian Ocean.

3905. Structure

Figure 3904 shows an idealized cross-section through a mature hurricane. The overall cyclonic circulation in the lower troposphere can vary greatly in expanse, but is typically a few hundred miles in diameter. The extent of hurricane-force winds outward from the center can also vary greatly, with diameters ranging from no more than 20 miles to 200 miles or more. The cyclonic spiral is marked by heavy cloud bands from which torrential rains fall, separated by areas of light rain or no rain at all. These spiral bands ascend in decks of cumulus and cumulonimbus clouds to the convective limit of cloud formation, where condensing water vapor is swept off as ice-crystal wisps of cirrus clouds.

In the lower few thousand feet, the cyclonic flow has a net component toward the center, which drives ascent with-

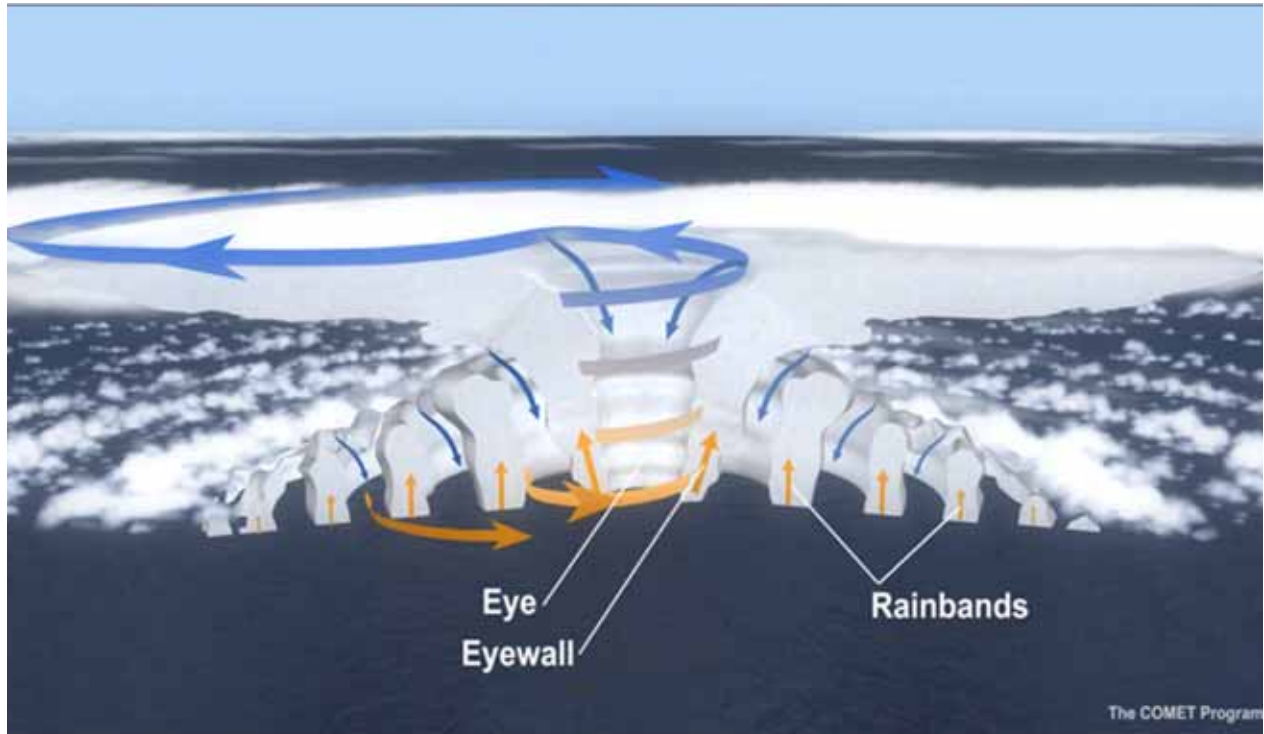

Figure 3904. Schematic cross-section of a mature hurricane. Used with permission of © UCAR/COMET Program.

in the eyewall and convective rainbands. Compensating downdrafts occur in the moat regions in between rainbands and in the eye, which at upper levels becomes much warmer than the surrounding air, and in the near environment of the cyclone. The intensity of the cyclonic flow is strongest just above the boundary layer, generally 1500-3000 feet in altitude, decreasing below that level due to surface friction and above that level because of the warm-core nature of the tropical cyclone. The cyclonic convergent flow through most of the troposphere becomes gradually replaced above 40,000 feet by anticyclonic divergent flow, which serves as the exhaust system of the hurricane heat engine. A satellite view of Hurricane Wilma (2005) is shown Figure 3905.

At the surface, winds generally increase inward as the eyewall is approached, although the increase is uneven, with stronger winds occurring within the rainbands and lighter winds in between them. In the eyewall, the typical mature hurricane is more likely to have sustained winds of 100-130 kts; however, sustained surface winds in excess of 180 kts have been recorded by remote sensing instruments onboard hurricane hunter aircraft. The winds then decrease to a near calm within the eye.

The diameter of the relatively calm eye can vary widely. In some of the most violent tropical cyclones, the eye might be just a few miles across, while in others the calm central region might cover 60-100 miles. Eye diameters of 15-30 miles are common. From the heated tower of maximum winds and cumulonimbus clouds, winds diminish rapidly to something less than 15 miles per hour in the eye; at the opposite wall, winds increase again, but come from

the opposite direction because of the cyclonic circulation of the storm. This sudden transformation of storm into comparative calm, and from calm into violence from another quarter is spectacular. The eye's abrupt existence in the midst of opaque rain squalls and hurricane winds, the intermittent bursts of blue sky and sunlight through light clouds in the core of the cyclone, and the galleried walls of cumulus and cumulonimbus clouds are unforgettable.

3906. Life Cycle

It is important to remember that tropical cyclones vary widely in nearly all their various aspects, and this is also true of their life cycle. Most take days or a week to evolve from a disorganized cluster of thunderstorms to hurricane strength, but this transition has also occurred in less than a day (e.g., 2007's Atlantic Hurricane Humberto). Once formed, a tropical cyclone may maintain itself in that status for as little as a day or as long as a month.

In this prototypical example, the precursor disturbance is a tropical wave that moves from Africa over the tropical Atlantic. The wave, or surface trough of low pressure, typically moves westward at 15 to 20 kts, with maximum winds of 20-30 kts (although some fast-moving tropical waves can have winds of 30-45 kts - these would not be considered tropical cyclones because they lack a closed surface circulation). If the environmental conditions are suitable, convective bands become organized into bands and pressure begins to fall, eventually causing west winds to develop to the south of a developing closed

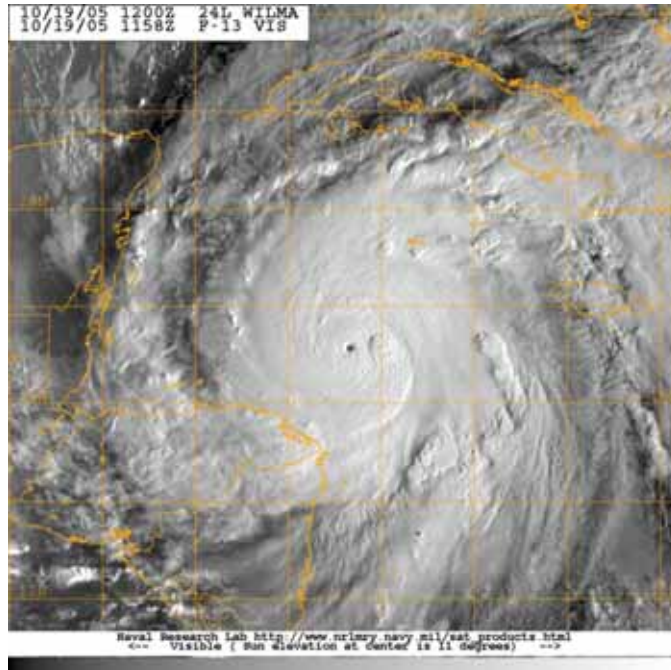

Figure 3905. Visible satellite image of 2005 Atlantic Hurricane Wilma (image courtesy Naval Research Laboratory)

low center, which marks the formation of a tropical cyclone.

Over the next several days, as the newly formed tropical depression moves west-northwestward, intensification occurs, at a rate largely governed by environmental factors that include vertical wind shear, ambient moisture, and sea-surface temperature. Large-scale weather features in the environment, such as the subtropical ridge or approaching mid-latitude troughs in the middle and upper troposphere, determine how far west the cyclone progresses before it begins to move out of the tropics. Within a few days the depression has become a hurricane, and may be approaching the North American continent or be moving through the Lesser or Greater Antilles. As it strengthens, the size of the cyclonic circulation and area of tropical storm force winds generally expands.

Once the hurricane begins to move out of the tropics, interactions with mid-latitude features increase. Typically, the cyclone will turn to the north (poleward) and often reaches its peak intensity near the most westernmost point in its track (the point of recurvature). After this, the mature hurricane usually encounters stronger wind shear and decreasing sea-surface temperatures below and may begin to interact with frontal systems. The cyclone turns northeastward and weakens while its circulation expands. The defining tropical characteristics of deep convection, strong pressure gradient and winds near the center, and warm core diminish as the system accelerates into the mid-latitudes, and the system either transitions to an extratropical low or becomes absorbed into one. See Figure 3906.

3907. Hazards

The high winds of a tropical cyclone inflict widespread damage when such a storm leaves the ocean and crosses land. Aids to navigation may be blown out of position or destroyed. Craft in harbors, often lifted by the storm surge, break moorings or drag anchor and are blown ashore and against obstructions. Ashore, trees are blown over, houses are damaged, power lines are blown down, etc. In a well-developed hurricane, the greatest damage usually occurs in the **right semicircle** a short distance from the center in the **eyewall**, where the strongest winds occur. As the storm continues on across land, its fury subsides faster than it would if it had remained over water. Wind gusts over water are usually 20-25% higher than the 1-minute mean winds. Higher gust ratios occur over land.

Tropical cyclones have produced some of the world's heaviest rainfalls. While average amounts range from 6 to 10 inches, totals near 100 inches over a 4-day period have been observed. A 24-hour world's record of 73.62 inches fell at Reunion Island during a tropical cyclone in 1952. Forward movement of the storm and land topography have a considerable influence on rainfall totals. Torrential rains can occur when a storm moves against a mountain range; this is common in the Philippines and Japan, where even weak tropical depressions produce considerable rainfall. A 24-hour total of 46 inches was recorded in the Philippines during a typhoon in 1911. As the remnants of Hurricane Camille crossed southern Virginia's Blue Ridge Mountains in August of 1969, there was nearly 30 inches of rain in about 8 hours. This caused some of the most disastrous floods in the state's history. In 2001, Tropical

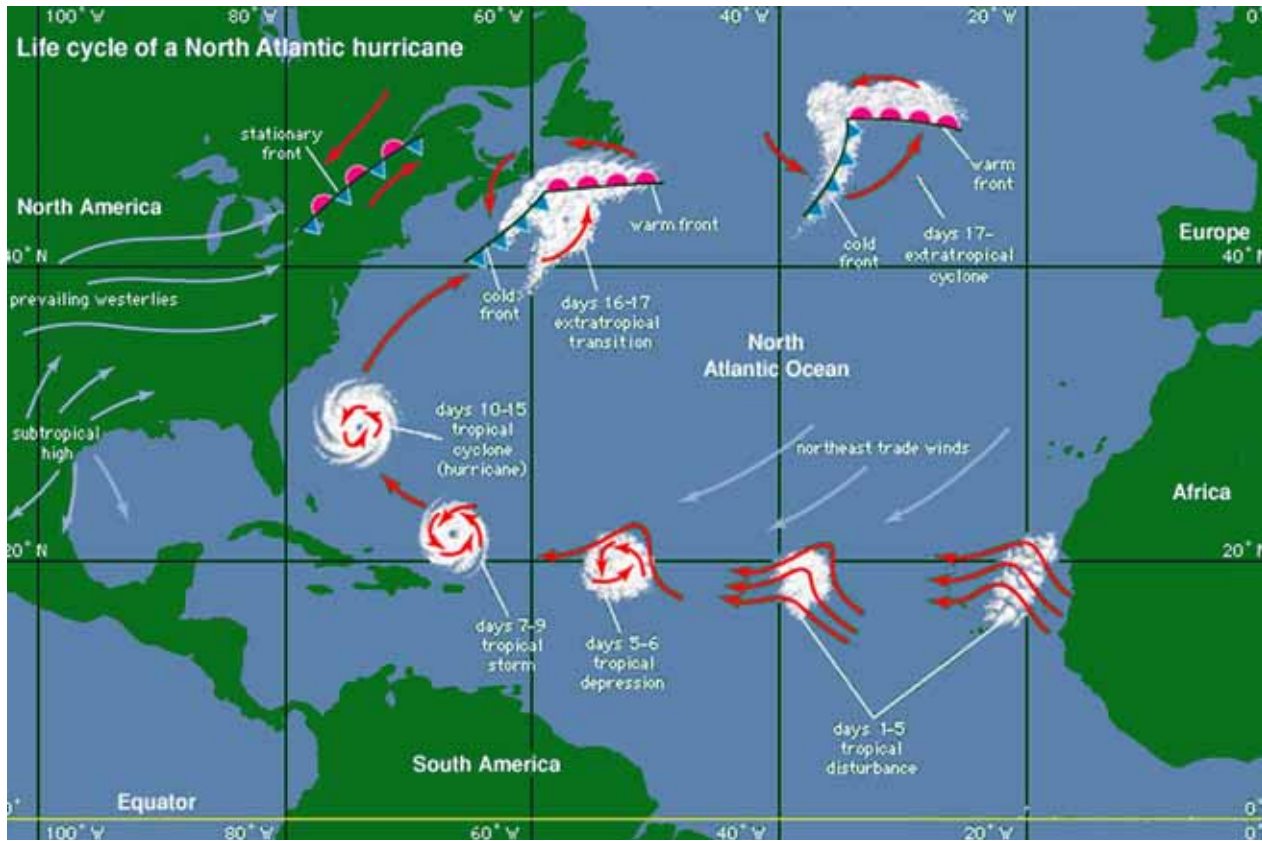

Figure 3906. Hurricane life cycle for the North Atlantic.

Storm Allison produced more than 30 inches of rain in the Houston, Texas area.

Flooding is an extremely destructive by-product of the tropical cyclone's torrential rains. Whether an area will be flooded depends on the physical characteristics of the drainage basin, rate and accumulation of precipitation, and river stages at the time the rains begin. When heavy rains fall over flat terrain, the countryside may lie under water for a month or so, and while buildings, furnishings, and underground power lines may be damaged, there are usually few fatalities. In mountainous or hill country, disastrous floods develop rapidly and can cause a great loss of life.

There have been reports in tropical cyclones of waves of up to 80 feet in height (e.g., Atlantic Hurricane Ivan in 2004) and numerous reports in the 30- to 40-foot category. However, in tropical cyclones, strong winds rarely persist for a sufficiently long time or over a large enough area to permit enormous wave heights to develop. The direction and speed of the wind changes more rapidly in tropical cyclones than in extratropical storms. Thus, the maximum duration and fetch for any wind condition is often less in tropical cyclones than in extratropical storms and the waves accompanying any given local wind condition are generally not so high as those expected with similar local wind conditions in the high-latitude storms. In Hurricane

Camille (1969), significant waves of 43 feet were recorded; an extreme wave height reached 72 feet.

Exceptional conditions may arise when waves of certain dimensions travel within the storm at a speed equal to the storm's speed, thus, in effect, extending the duration and fetch of the wave and significantly increasing its height. This occurs most often to the right of the track in the Northern Hemisphere (left of the track in the Southern Hemisphere). Another condition that may give rise to exceptional wave heights is the intersection of waves from two or more distinct directions. This may lead to a zone of confused seas in which the heights of some waves will equal the sums of each individual wave train. This process can occur in any quadrant of the storm, so it should not be assumed that the highest waves will always be encountered to the right of the storm track in the Northern Hemisphere (left of the track in the Southern Hemisphere).

When these waves move beyond the influence of the generating winds, they become known as **swell**. They are recognized by their smooth, undulating form, in contrast to the steep, ragged crests of wind waves. This swell, particularly that generated by the right side of the storm, can travel a thousand miles or more and may produce tides 3 or 4 feet above normal along several hundred miles of coastline. It may also produce tremendous surf over offshore reefs that normally are calm.

When a tropical cyclone moves close to a coast, wind often causes a rise in water level along the coast known as **storm surge**. This surge is usually confined to the right of the track in the Northern Hemisphere (left of the track in the Southern Hemisphere) or to areas with prolonged periods of onshore flow. It most often occurs with the approach of the storm, but in some cases, where a surge moves into a long channel, the effect may be delayed. Occasionally, the greatest rise in water is observed on the opposite side of the track, when northerly winds funnel into a partially land-locked harbor. The surge could be 3 feet or less, or it could be 20 feet or more, depending on the combination of factors involved. Factors that determine the amount of storm surge include the local bathymetry and topography, the intensity of the cyclone, the size of the wind field, and the forward speed and direction of motion of the cyclone. The highest storm surges are caused by a slow-moving tropical cyclone of large diameter because both of these effects result in greater duration of wind in the same direction. The effect is greatest in a partly enclosed body of water, such as the Gulf of Mexico, where the concave coastline does not readily permit the escape of water. It is least on small islands, which present little obstruction to the flow of water.

A hurricane's storm surge has occasionally been described as a wall of water that moves rapidly toward the coastline. Authenticated cases of such a rapid rise are rare, but regardless, some of the world's greatest natural disasters have occurred as a result of storm surge. In India, such a disaster occurred in 1876, between Calcutta and Chittagong, and drowned more than 100,000 persons.

There have been many instances of **tornadoes** occurring within the circulation of tropical cyclones. Most of

these have been associated with tropical cyclones of the North Atlantic Ocean and have occurred in the West Indies and along the gulf and Atlantic coasts of the United States. They are usually observed in the forward semicircle or along the advancing periphery of the storm. These tornadoes are usually short-lived and less intense than those that occur in the Midwestern United States. In 2004, Hurricane Ivan was associated with 117 tornadoes.

When proceeding along a shore recently visited by a tropical cyclone, a navigator should remember that time is required to restore aids to navigation which have been blown out of position or destroyed. In some instances, the aid may remain but its light, sound apparatus, or radio beacon may be inoperative. Landmarks may have been damaged or destroyed and in some instances the coastline and hydrography *may be changed*.

3908. Saffir-Simpson Hurricane Wind Scale

The Saffir-Simpson Hurricane Wind Scale is a 1 to 5 rating based on a hurricane's sustained winds (see Table 3908). This scale estimates potential shore side property damage and is provided here in Bowditch as a reference for mariners.

Hurricanes reaching Category 3 and higher are considered major hurricanes because of their potential for significant loss of life and property damage. Category 1 and 2 storms are still dangerous and require preventative measures. In the Western Pacific, the term "*super typhoon*" is used for tropical cyclones with sustained winds exceeding 150 mph.

Category	Sustained Winds	Description
1	74-95 mph	Very dangerous winds will produce some damage: Well-constructed frame homes could have damage to roof, shingles, vinyl siding and gutters. Large branches of trees will snap and shallowly rooted trees may be toppled. Extensive damage to power lines and poles likely will result in power outages that could last a few to several days.
2	96-110 mph	Extremely dangerous winds will cause extensive damage: Well-constructed frame homes could sustain major roof, shingles, and siding damage. Many shallowly rooted trees will be snapped or uprooted and block numerous roads. Near-total power loss is expected with outages that could last from several days to weeks.
3	111-129 mph	Devastating damage will occur: Well-built framed homes may incur major damage or removal or roof, decking and gable ends. Many trees will be snapped or uprooted, blocking numerous roads. Electricity and water will be unavailable for several days to weeks after the storm passes.

Table 3908. Saffir-Simpson Hurricane Wind Scale.

Category	Sustained Winds	Description
4	130-156 mph	Catastrophic damage will occur: Well-built framed homes can sustain severe damage with loss of most of the roof structure and/or some exterior walls. Most trees will be snapped or uprooted and power poles downed. Fallen trees and power poles will isolate residential areas. Power outages will last weeks to possibly months. Most of the area will be uninhabitable for weeks or months.
5	157 mph or higher	Catastrophic damage will occur: A high percentage of framed houses will be destroyed, with total roof failure and wall collapse. Fallen trees and power poles will isolate residential areas. Power outages will last for weeks to possibly months. Most of the area will be uninhabitable for weeks or months.

Table 3908. Saffir-Simpson Hurricane Wind Scale.

3909. A Tropical Cyclone Encounter from the Mariner's Perspective

An early indication of the approach of a **tropical cyclone** is the presence of a long **swell**. In the absence of a tropical cyclone, the crests of swell in the deep waters of the Atlantic pass at the rate of perhaps eight per minute. Swell generated by a hurricane is about twice as long, the crests passing at the rate of perhaps four per minute. Swell may be observed several days before arrival of the storm.

When the storm center is 500 to 1,000 miles away, the barometer usually rises a little, and the skies are relatively clear. **Cumulus** clouds, if present at all, are few in number and their vertical development appears suppressed. The barometer usually appears restless, pumping up and down a few hundredths of an inch.

As the tropical cyclone comes nearer, a cloud sequence begins (Figure 3909) that resembles what is typically associated with the approach of a warm front in middle latitudes. Snow-white, fibrous "**mare's tails**" (cirrus) appear when the storm is about 300 to 600 miles away. Usually these seem to converge, more or less, in the direction from which the storm is approaching. This convergence is particularly apparent at about the time of sunrise and sunset.

Shortly after the cirrus appears, but sometimes before, the barometer starts a long, slow fall. At first the fall is so gradual that it only appears to alter somewhat the normal daily cycle (two maxima and two minima in the Tropics). As the rate of fall increases, the daily pattern is completely lost in the more or less steady fall.

The cirrus becomes more confused and tangled, and then gradually gives way to a continuous veil of **cirrostratus**. Below this veil, **altostratus** forms, and then **stratocumulus**. These clouds gradually become more dense, and as they do so, the weather becomes unsettled. A fine, mist-like rain begins to fall, interrupted from time to time by rain showers. The barometer has fallen perhaps a tenth of an inch.

As the fall becomes more rapid, the wind increases in

gustiness and its speed becomes greater, reaching perhaps 22 to 40 knots (**Beaufort** 6-8). On the horizon appears a dark wall of heavy **cumulonimbus**, called the **bar of the storm**. This is the heavy bank of clouds comprising the main mass of the cyclone. Portions of this heavy cloud become detached from time to time, and drift across the sky, accompanied by rain squalls and wind of increasing speed. Between squalls, the cirrostratus can be seen through breaks in the stratocumulus.

As the bar approaches, the barometer falls more rapidly and wind speed increases. The seas, which have been gradually mounting, become tempestuous. Squall lines, one after the other, sweep past in ever increasing number and intensity.

With the arrival of the bar, the day becomes very dark, squalls become virtually continuous, and the barometer falls precipitously, with a rapid increase in wind speed. The center may still be 100 to 200 miles away in a fully developed tropical cyclone. As the center of the storm comes closer, the ever-stronger wind shrieks through the rigging and about the superstructure of the vessel. As the center approaches, rain falls in torrents. The wind fury increases. The seas become mountainous. The tops of huge waves are blown off to mingle with the rain and fill the air with water. Visibility is virtually zero in blinding rain and spray. Even the largest and most seaworthy vessels become virtually unmanageable and may sustain heavy damage. Less sturdy vessels may not survive. Navigation virtually stops as safety of the vessel becomes the only consideration. The awesome fury of this condition can only be experienced. Words are inadequate to describe it.

If the **eye of the storm** passes over the vessel, the winds suddenly drop to a breeze as the wall of the eye passes. The rain stops, and the skies clear sufficiently to permit the sun or stars to shine through holes in the comparatively thin cloud cover. Visibility improves. Mountainous seas approach from all sides in complete confusion. The barometer reaches its lowest point, which may be 1.5 or 2 inches below normal in fully developed tropical cyclones. As the wall on the opposite side of the eye arrives, the full fury of

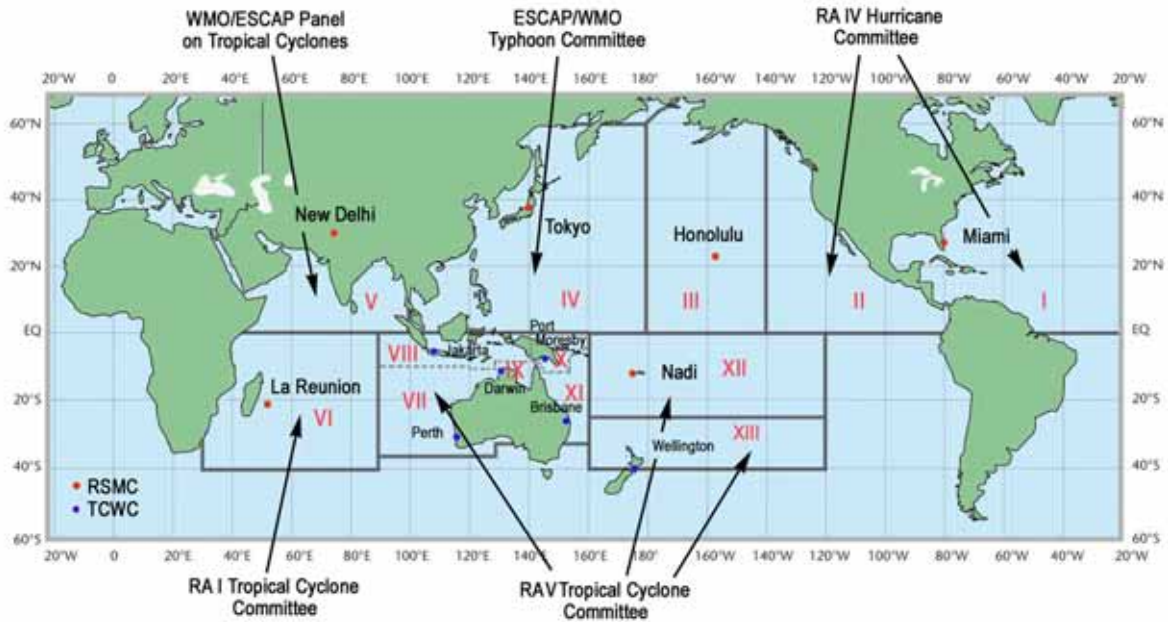

Figure 3910a. Location and area of responsibility for the WMO-recognized tropical cyclone Regional Specialized Meteorological Centers and Tropical Cyclone Warning Centers (WMO).

Tasman Sea: **TCWC-Wellington**/Meteorological Service of New Zealand, Ltd. See Figure 3910j for a link to current forecasts from the TCWC-Wellington.

TCWC-Jakarta/ Indonesian Meteorological and Geophysical Agency, Indonesia. See Figure 3910k for a link to current forecasts from the TCWC Jakarta.

And lastly, the **U.S. Joint Typhoon Warning Center** (<https://metoc.ndbc.noaa.gov/JTWC/>) provides certain products worldwide for use by U.S. government agencies. See Figure 3910l for a link to current forecasts from the JTWC.

For mariners lacking access to the internet, marine weather broadcasts and radio facsimile weather maps are an important source of information. In the Atlantic basin, the USCG broadcasts are available via high frequency (HF) voice from Chesapeake (NMN) and New Orleans (NMG). In the Pacific basin, HF voice broadcasts are made from Pt. Reyes (NMC), Kodiak (NOJ), Honolulu (NMO) and Guam (NRV). Some marine facsimile charts intentionally overlap basins with broadcasts on several frequencies from Boston (NMF), New Orleans (NMG), Kodiak (NOJ), Pt. Reyes (NMC), and Honolulu (KVM70). Other sources include VHF, HF Simplex Teletype Over Radio (SITOR) or Narrow Band Direct Printing (NBDP), Global Maritime Distress and Safety System (GMDSS) programs, Navigational Telex (NAVTEX) and amateur ham radio weather nets.

Faster computers, improvements in modeling, and increases in the amount of satellite-based atmospheric observations have resulted in greatly improved tropical cy-

clone track forecasts. Figure 3910m shows the progress made in predicting the path of tropical cyclones by the National Hurricane Center (RSMC-Miami); similar progress has been noted by other RSMCs. In the decade of the 1970s, the average 72-hour Atlantic basin tropical storm or hurricane forecast error was more than 350 nautical miles, but today that average error is only a little over 100 nautical miles.



Figure 3910b. RSMC Miami
<https://www.nhc.noaa.gov/index.shtml>



Figure 3910c. RSMC Honolulu
<https://www.prh.noaa.gov/cphc/>



Figure 3910d. RSMC Tokyo <http://www.jma.go.jp/en/typh/>



Figure 3910h. RSMC Nadi
http://www.met.gov.fj/current_warnings.php



Figure 3910e. RSMC Tropical Cyclones New Delhi/India
<http://www.imd.gov.in/>



Figure 3910i. TCWC Australia Bureau of Meteorology
<http://www.bom.gov.au/weather/cyclone/>



Figure 3910f. RSMC La Reunion
<http://www.meteofrance.re/cyclone/activite-cyclonique-en-cours>



Figure 3910j. TCWC Wellington
http://www.metservice.co.nz/forecasts/severe_weather.asp



Figure 3910g. Australian Bureau of Meteorology regions.



Figure 3910k. TCWC Jakarta <http://www.bmkg.go.id/>



Figure 3910l. U.S. Joint Typhoon Warning Center.
<https://metoc.ndbc.noaa.gov/JTWC/>

This is not to say that such forecasts are without error; in the Atlantic basin 10% of the National Hurricane Center's 72-hr forecasts are currently off by 200 nautical miles or more. To help quantify forecast uncertainty in a manner

most helpful to users, many tropical cyclone forecasts are now expressed in a probabilistic framework mentioned in the following paragraphs.

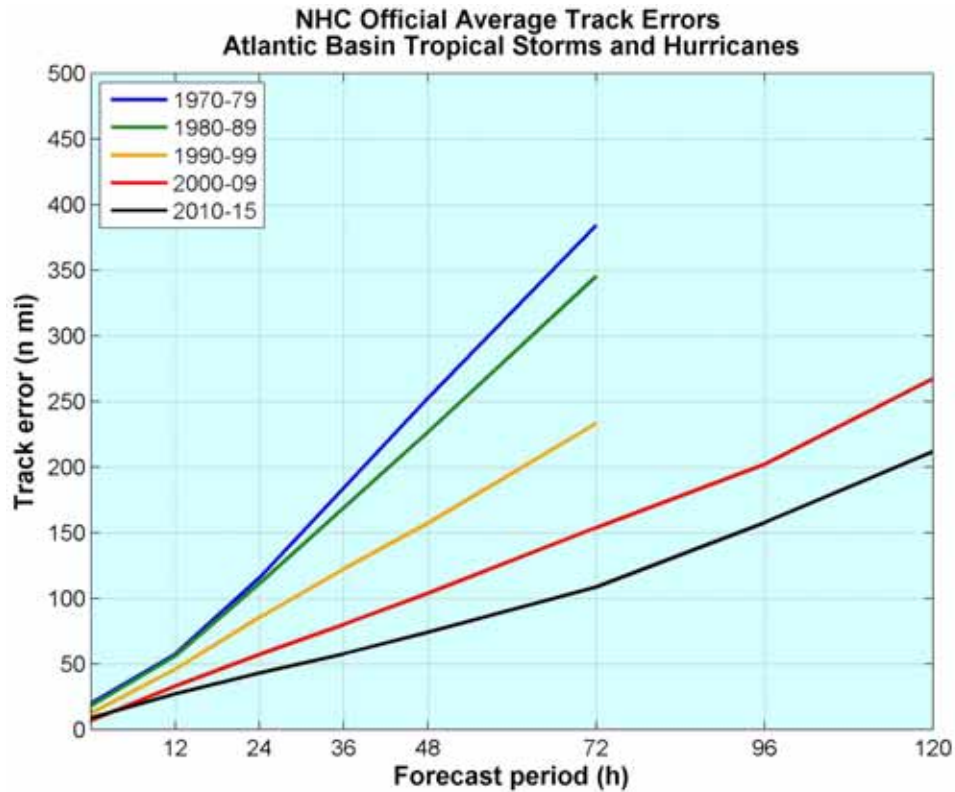

Figure 3910m. National Hurricane Center official track forecast accuracy for Atlantic basin tropical storms and hurricanes by decade.

3911. Tropical Cyclone Forecast Products

Each RSMC has its own collection of forecast and



Figure 3911a. Link to the NHC User's Guide for their tropical cyclone products.

https://www.nhc.noaa.gov/pdf/NHC_Product_Description.pdf

warning products. Responsible mariners will become familiar with the offerings of the RSMCs overseeing the areas in which they operate. Here, we discuss some of the tropical cyclone products prepared by the **National Hurricane**

Center (NHC). See Figure 3911a for a link to the User's Guide to tropical cyclone products prepared by the National Hurricane Center (NHC).

Whenever a tropical cyclone is active, the NHC issues tropical cyclone advisory packages comprising several official text and graphical products. This suite of advisory products is issued every 6 hours at 0300, 0900, 1500, and 2100 UTC. The primary text products are the **Public Advisory**, the **Forecast/Advisory**, the **Tropical Cyclone Discussion**, and the **Wind Speed Probability** product. Graphical products include the track forecast cone/watch-warning graphic, wind speed probability graphics, the maximum intensity probability table, the tropical cyclone wind field graphic, and a cumulative wind history graphic. A potential storm surge flooding map, tropical cyclone storm surge probabilities, and exceedance probability graphics are also issued with each advisory, whenever a hurricane watch or hurricane warning is in effect for any portion of the Gulf or Atlantic coasts of the continental United States

and on a case by case basis for tropical storm watches and warnings. When a tropical cyclone dissipates, advisories are discontinued. If a tropical cyclone becomes a post-tropical cyclone, NHC may continue issuing advisories if necessary to protect life and property.

The *Tropical Weather Outlook* discusses significant areas of disturbed weather and their potential for development into a tropical cyclone during the next 5 days, including a categorical forecast of the probability of tropical cyclone formation during the first 48 hours and during the entire 5-day forecast period. The 48 hour and 5-day probabilities of formation for each disturbance are given to the nearest 10% and expressed in terms of one of the following categories: low probability of development (0-30%), medium probability (40-60%), and high probability of development (70-100%). The Outlook also includes a general description of locations of any active cyclones during the first 24 hours of their existence. Tropical Weather Outlooks are issued every six hours from 1 June - 30 November for the Atlantic basin and from 15 May-30 November for the eastern North Pacific basin at 0000, 0600, 1200, and 1800 UTC.

The *Tropical Cyclone Public Advisory* is the primary tropical cyclone information product intended for a general audience. It provides critical tropical cyclone watch, warning, and forecast information for the protection of life and property. The Public Advisory has five sections:

1) This section contains the cyclone position in latitude and longitude coordinates, its distance from a well-known reference point, the maximum sustained winds, the cyclone's current direction and speed of motion, and the estimated or measured minimum central pressure.

2) A summary of all current coastal watches and warnings for the cyclone with recent changes to the watches and warnings highlighted at the top.

3) A discussion of the cyclone's current characteristics, including location, motion, intensity, and pressure and a general description of the predicted track and intensity of the cyclone over the next 24 to 48 hours. Any pertinent weather observations will also be included in this section.

4) A section that includes information on hazards to land such as storm surge/tide, wind, rainfall, tornadoes, and rip currents associated with the cyclone.

5) A section that states the time of the next advisory issuance.

Public Advisories are part of the suite of products issued for active cyclones every six hours at 0300, 0900, 1500, and 2100 UTC. When coastal watches or warnings are in effect, *Intermediate Public Advisories* are issued at 3-hour intervals between the regular *Public Advisories*. *Special Public Advisories* may be issued at any time to advise of an unexpected significant change in the cyclone or when watches or warnings for the United States are to be issued.

The *Tropical Cyclone Forecast/Advisory* (formerly known as the *Marine Advisory*) contains current and forecasted storm information. It contains a list of all current

coastal watches and warnings, cyclone position, intensity, and direction and speed of motion. It also includes the current maximum radial extent of 12-ft seas, as well as the maximum radial extent of winds of 34, 50, and 64 kt in each of four quadrants around the storm. The *Forecast/Advisory* contains quantitative forecast information on the track and intensity of the cyclone valid 12, 24, 36, 48, 72, 96, and 120 hours from the forecast's nominal initial time, with size information forecast out to 72 hours.

The *Forecast/Advisory* also contains the predicted status of the cyclone for each forecast time. This status may include any of the following: inland, dissipating, dissipated, or post tropical advisories. An **extratropical cyclone** is a cyclone of any intensity for which the primary energy source results from the temperature contrast between warm and cold air masses. Forecast/Advisories are issued for active cyclones every six hours at 0300, 0900, 1500, and 2100 UTC. *Special Forecast/Advisories* may be issued at any time to advise of an unexpected significant change in the cyclone or when coastal watches or warnings are to be issued.

The *Tropical Cyclone Discussion* describes the rationale for the forecaster's analysis and forecast of a tropical cyclone. It will typically discuss the observations justifying the analyzed intensity of the cyclone, a description of the environmental factors expected to influence the cyclone's future track and intensity, and a description of the numerical guidance models. It may also describe the forecaster's degree of confidence in the official forecast, discuss possible alternate scenarios, and highlight unusual hazards. The product also includes a table of forecast positions and intensities in knots and miles per hour out to 120 hours. This table also indicates the forecast status of the cyclone. Tropical Cyclone Discussions are issued for active cyclones every six hours at 0300, 0900, 1500, and 2100 UTC. *Special Discussions* may be issued at any time to advise of an unexpected significant change in the cyclone or when coastal watches or warnings are to be issued.

The *Tropical Cyclone Surface Wind Speed Probability* product provides the likelihood (expressed as a percentage) of sustained (1-min average) winds meeting or exceeding specific thresholds at particular locations. This product is available in text and graphical formats (example shown in Figure 3911b). These probabilities are based on the track, intensity, and wind structure (size) forecasts from the National Hurricane Center and their historical error characteristics. In addition, they consider the amount of agreement or disagreement among the primary tropical cyclone track models.

Location-specific information is given in the form of probabilities of sustained winds occurring at or above the thresholds of 34, 50 and 64 kts over specific periods of time as discussed below. These probabilities are provided for coastal and inland cities as well as for offshore locations (e.g., buoys). These probabilities are based on the track, intensity, and wind structure (size) forecasts from the

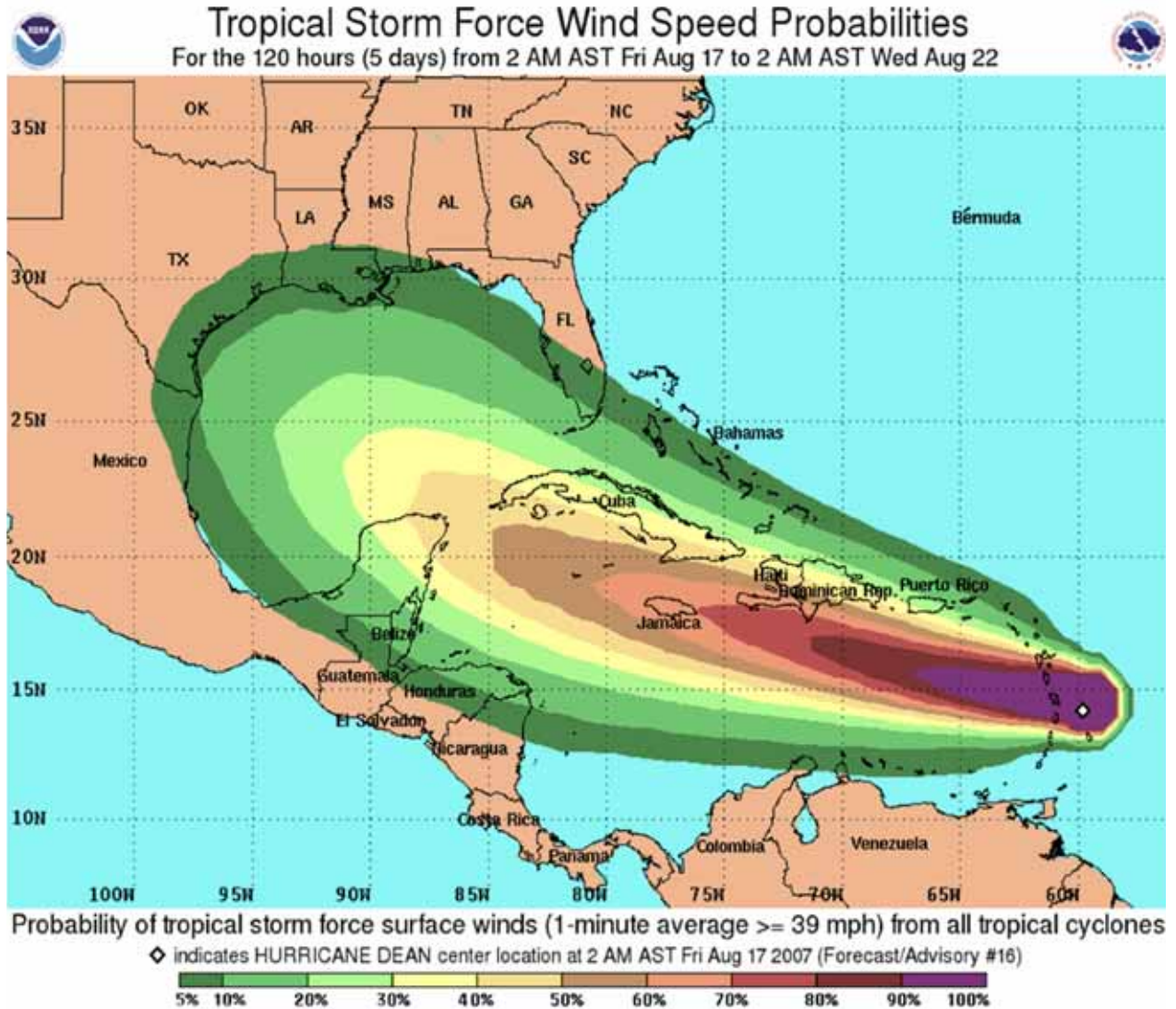

Figure 3911b. Tropical cyclone surface wind speed probability graphic.

National Hurricane Center and their historical error characteristics.

There are two kinds of location-specific probabilities used in this product: *cumulative occurrence* and *onset probabilities*.

Cumulative occurrence probabilities - these values tell you the probability the wind event will occur sometime during the specified cumulative forecast period (0-12, 0-24, 0-36 hours, etc.) at each specific point. These values are provided in both the text and graphical form of the *Surface Wind Speed Probability* product (see Figure 3911b). In the text product, the cumulative probabilities appear in parentheses. The graphical products depict only cumulative values.

Onset probabilities - These values tell you the probability the wind event will start sometime during the specified individual forecast period (0-12, 12-24, 24-36 hours, etc.) at each specific point. These values are provided

only in the text NHC product. They are the values outside of the parentheses.

This product is issued for active cyclones every six hours at 0300, 0900, 1500, and 2100 UTC. Special Wind Speed Probability products may be issued at any time to advise of an unexpected significant change in the cyclone or when coastal watches or warnings are to be issued.

It is important for users to realize that probabilities that may seem relatively small (e.g., 5-10%) may still be quite significant. Users are urged to consider the potentially large costs (in terms of lives, property, etc.) of not preparing for an extreme event.

The *Tropical Cyclone Update (TCU)* is issued to inform users of significant changes in a tropical cyclone between regularly scheduled public advisories. Such uses include:

- To provide timely information of an unusual nature,

such as the time and location of landfall, or to announce an expected change in intensity that results in an upgrade or downgrade of status (e.g., from a tropical storm to a hurricane).

- To provide a continuous flow of information regarding the center location of a tropical cyclone when watches or warnings are in effect and the center can be easily tracked with land-based radar.
- To provide advance notice that significant changes to storm information will be conveyed shortly, either through a subsequent TCU or through a *Special Advisory*.
- To announce changes to international watches or warnings made by other countries, or to cancel U.S. watches or warnings.
- To issue a U.S. watch or warning, but only if the TCU precedes a special advisory that will contain the same watch/warning information, and indicates the special advisory will be issued shortly.

When a TCU is issued and any storm summary information has changed from the previous *Public Advisory* (e.g., upgrade from tropical storm to hurricane), a storm summary section identical in format to that found in the *Public Advisory* will also be included. TCUs issued to provide updated center position information when watches/warnings are in effect are issued in between scheduled TCUs near the beginning of each hour. All other TCUs are issued on an event-driven basis.

In addition to the text products described above, the National Hurricane Center website (see Figure 3911c for link) also contains a number of tropical cyclone graphical products. The most important of these are described below.



Figure 3911c. National Hurricane Center (NHC) website.
(<http://www.hurricane.gov>)

The *Tropical Cyclone Track Forecast Cone and Watch/Warning Graphic* (Figure 3911d) depicts the most recent NHC track forecast of the center of a tropical cyclone along with an approximate representation of associated coastal areas under a hurricane warning (red), hurricane watch (pink), tropical storm warning (blue) and tropical storm watch (yellow). The orange circle indicates the current position of the center of the tropical cyclone. The black dots show the NHC forecast position of the center at the times indicated. The letter inside the dot indicates the forecast strength of the cyclone category: (D)epression,

(S)torm, (H)urricane, (M)ajor hurricane, or remnant (L)ow. Systems forecast to be post-tropical are indicated by white dots with black letters indicating intensity using the thresholds given above. For example, a post-tropical system forecast to have winds of 65 kts would be depicted by a black H inside a white dot, even though it is not a hurricane.

The cone represents the probable track of the center of a tropical cyclone, and is formed by enclosing the area swept out by a set of circles (not shown) along the forecast track (at 12, 24, 36 hours, etc.). The size of each circle is set so that two-thirds of historical official forecast errors over a 5-year sample fall within the circle.

The *5-day Graphical Tropical Weather Outlook* (Figure 3911e) provides formation potential for individual disturbances during the next 5-day period. The areas enclosed on the graph represent the potential formation area during the forecast period. The areas are color-coded based on the potential for tropical cyclone formation during the next 5-days. Areas in yellow indicate a low probability of development (0-30%), orange indicates medium likelihood (40-60%), and red indicates a high likelihood of development (70-100%). The location of existing disturbances is indicated by an X. If the formation potential of an existing disturbance does not include the area in which the disturbance is currently located, an arrow will connect the current location of the disturbance to its area of potential formation. Areas without an X or connected by an arrow to an X indicate that the disturbance does not currently exist, but is expected to develop during the 5-day period. On the NHC website the graphic is interactive; users can mouse over disturbances in the graphic and pop-up windows will appear with the text Outlook discussion for that disturbance. Clicking on a disturbance will take the user to a graphic that shows only that disturbance. Active tropical cyclones are not depicted on this graphic. Graphical Tropical Weather Outlooks are issued every six hours from 1 June-30 November for the Atlantic basin and from 15 May-30 November for the eastern North Pacific basin, at 0000, 0600, 1200, and 1800 UTC. The Graphical Tropical Weather Outlook is also updated whenever a Special Tropical Weather Outlook is issued.

3912. Marine Forecast Products

The *Tropical Cyclone Danger Graphic* is an NHC product traditionally based on the “Mariner’s 1-2-3 rule”. The graphics (one for the North Atlantic and one for the eastern North Pacific) depict the danger area associated with tropical cyclones within the area from the equator to 60°N between 0° and 100°W, including the Pacific east of 100°W, and from the equator to 40°N between 80°W and 175°W, including the Gulf of Mexico and Western Caribbean. These graphics are posted on the NHC webpage, and are also transmitted by radio fax via Boston, New Orleans, and Pt. Reyes transmitters.

The tropical cyclone danger graphic is intended to de-

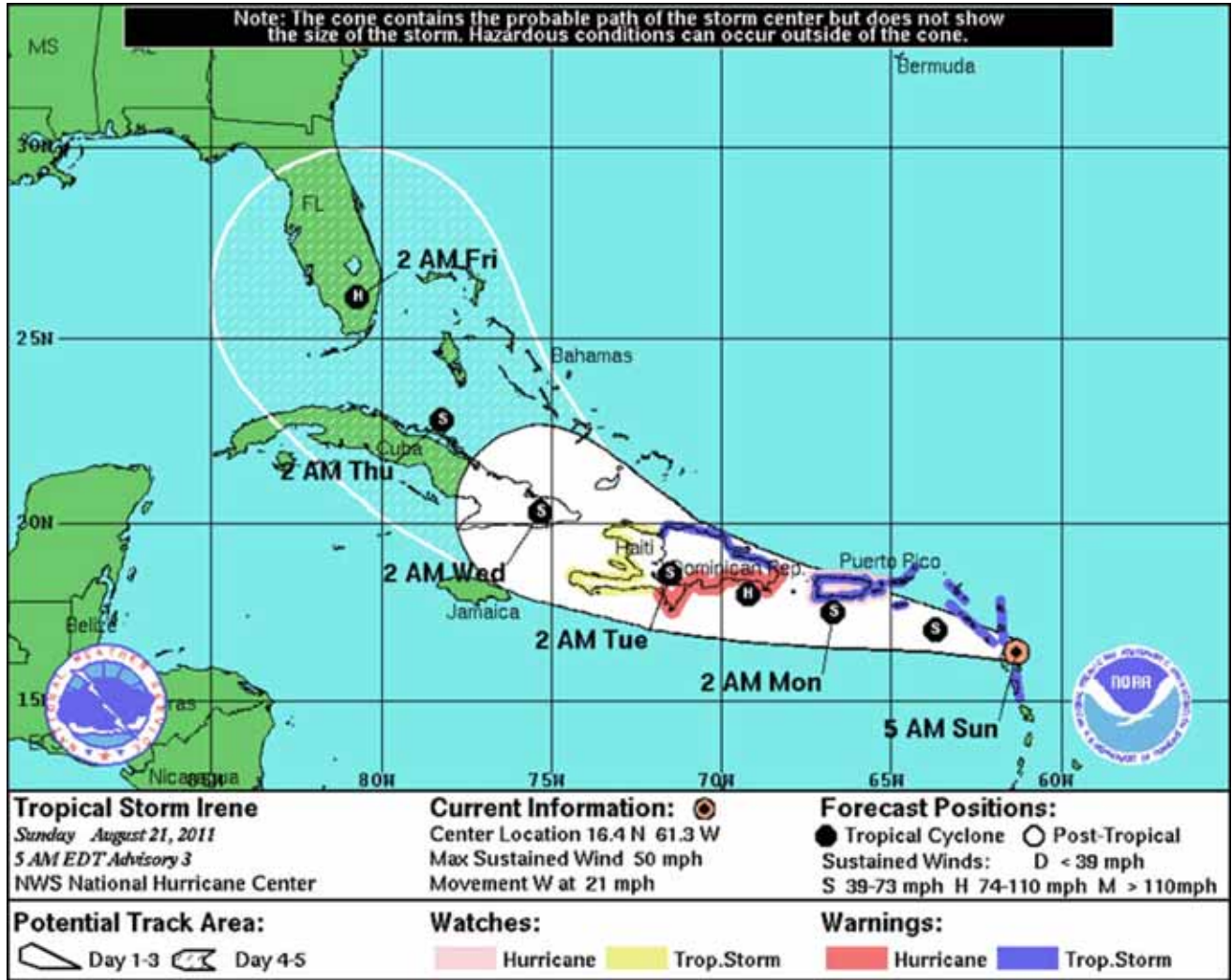

Figure 3911d. Tropical cyclone track forecast cone and watch/warning graphic.

predict the forecast track and corresponding area of avoidance for all active tropical cyclones and to depict areas for which tropical cyclone formation is possible within the next 72 hours over the Atlantic and East Pacific waters between May 15 and November 30. Traditionally, the three-day forecast track of each active tropical cyclone is depicted along with a shaded “danger” region, or area of avoidance. The danger area is determined by adding 100, 200, and 300 nautical miles to the tropical storm force radii (34 knots) at the 24, 48, and 72-hour forecast positions, respectively (hence the “1-2-3” nomenclature).

Because of advances in tropical cyclone prediction, the 1-2-3 rule (see Figure 3912a) has become outdated and the Danger Graphic based on that rule depicts excessively large potential tropical cyclone danger areas. In 2012, the National Hurricane Center developed an alternative experimental version of the graphic based on the wind

speed probability calculations discussed above. One advantage of this approach is that it allows the depiction of any particular desired level of risk. In addition, the calculation considers the spread of the model guidance and therefore has some situational variability. It also considers uncertainty in the forecasts of tropical cyclone size and intensity as well as the track of the cyclone.

NHC discontinued use of the Mariner's 1-2-3 rule in 2016. Tropical cyclone danger areas are now depicted to show the areas encompassed by the 5% and 50% 34-knots wind speed probability contours - the 5% contour is meant to highlight areas where-tropical-storm force winds are possible and the 50% contour is meant to highlight areas where those winds are likely. An example of the new Danger Graphic is given in Figure 3912b.

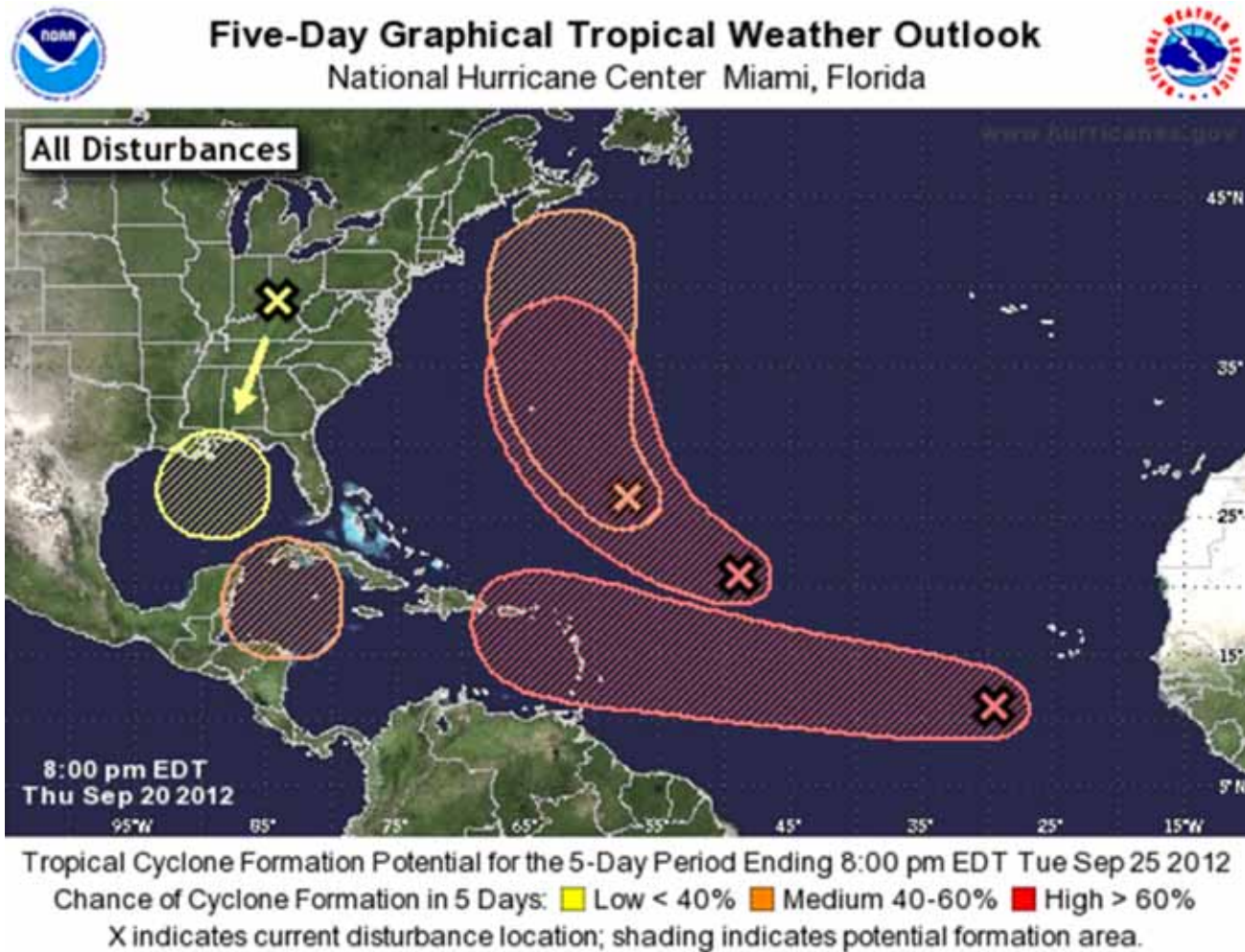

Figure 3911e. Five-day graphical tropical weather outlook.

AVOIDING TROPICAL CYCLONES

3913. Approach and Passage of a Tropical Cyclone

Given the improvements in forecasting and the growing availability of receiving these forecasts at sea, the best way to avoid an encounter with a tropical cyclone is to monitor the forecast products from the appropriate RSMC or TCWC and take early action. Early action means determining the tropical cyclone's location and direction of travel relative to the vessel and maneuvering the vessel appropriately.

A mariner should be well versed in identifying and characterizing environmental changes to maintain situational awareness and safety around these storms. The below rules of thumb should be used alongside the official forecasts to identify and maneuver around tropical cyclones.

The presence of an exceptionally long swell is usually

the first visible indication of the existence of a tropical cyclone. In deep water it approaches from the general direction of origin (the position of the storm center when the swell was generated). However, in shoaling water this is a less reliable indication because the direction is changed by refraction, the crests being more nearly parallel to the bottom contours.

When the cirrus clouds appear, their point of convergence provides an indication of the direction of the storm center. If the storm is to pass well to one side of the observer, the point of convergence shifts slowly in the direction of storm movement. If the storm center will pass near the observer, this point remains steady. When the bar becomes visible, it appears to rest upon the horizon for several hours. The darkest part of this cloud is in the direction of the storm center. If the storm is to pass to one side, the bar appears to drift slowly along the horizon. If the storm is heading di-

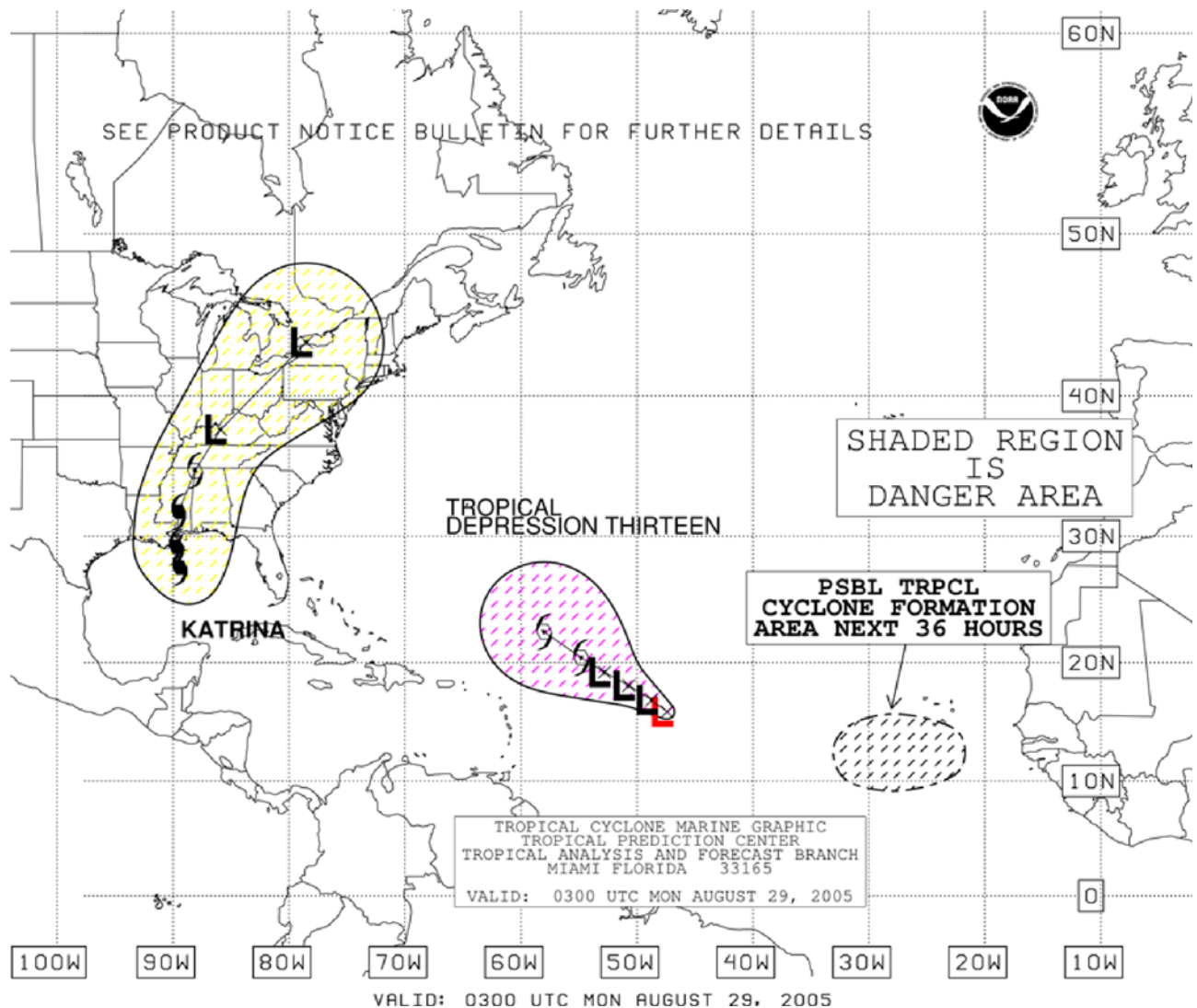

Figure 3912a. Former Tropical Cyclone Danger Graphic based on the Mariner's 1-2-3 rule.

rectly toward the observer, the position of the bar remains fixed. Once within the area of the dense, low clouds, one should observe their direction of movement, which is almost exactly along the isobars, with the center of the storm being 90° from the direction of cloud movement (left of direction of movement in the Northern Hemisphere and right in the Southern Hemisphere). The winds are probably the best guide to the direction of the center of a tropical cyclone. The circulation is cyclonic, but because of the steep pressure gradient near the center, the winds there blow with greater violence and are more nearly circular than in extratropical cyclones.

According to **Buys Ballot's law**, an observer whose back is to the wind has the low pressure on his left in the Northern Hemisphere and on his right in the Southern Hemisphere. If the wind followed circular isobars exactly, the center would be exactly 90° from behind when facing away from the wind. However, the track of the wind is usu-

ally inclined somewhat toward the center, so that the angle from dead astern varies between perhaps 90° to 135° . The inclination varies in different parts of the same storm. It is least in front of the storm and greatest in the rear, since the actual wind is the vector sum of the pressure gradient and the motion of the storm along the track. A good average is perhaps 110° in front and 120 - 135° in the rear. These values apply when the storm center is still several hundred miles away. Closer to the center, the wind blows more nearly along the isobars, the inclination being reduced by one or two points at the wall of the eye. Since wind direction usually shifts temporarily during a squall, its direction at this time should not be used for determining the position of the center. The approximate relationship of wind to isobars and storm center in the Northern Hemisphere is shown Figure 3913a.

When the center is within a vessel's radar range, it will probably be visible on the scope. However, since the radar

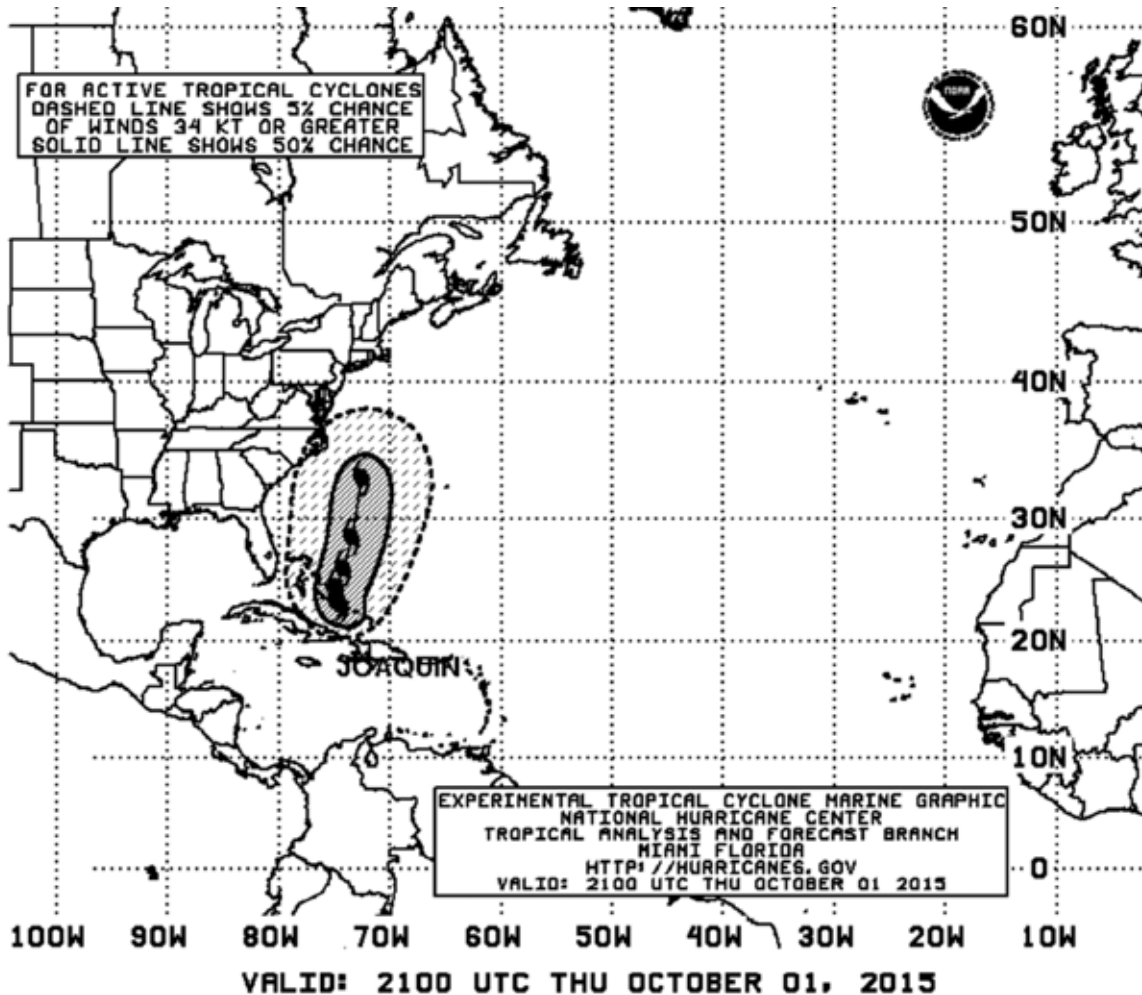

Figure 3912b. Probability-based Tropical Cyclone Danger Graphic.

return is predominantly from the rain, results can be deceptive, and other indications should not be neglected. Figure 3913b shows a radar presentation of a tropical cyclone. If the eye is out of range, the spiral bands may indicate its direction from the vessel. Tracking the eye or upwind portion of the spiral bands enables determining the direction and speed of movement; this should be done for at least 1 hour because the eye tends to oscillate. The tracking of individual cells, which tend to move tangentially around the eye, for 15 minutes or more, either at the end of the band or between bands, will provide an indication of the wind speed in that area of the storm.

Distance from the storm center is more difficult to determine than direction. Radar is perhaps the best guide. However, the rate of fall of the barometer is some indication.

3914. Statistical Analysis of Barometric Pressure

The lowest sea level pressure ever recorded was 870 mb in Super Typhoon Tip in October 1979. In the Atlantic

basin, Hurricane Wilma produced a minimum central pressure of 882 mb in 2005, and 2015's Hurricane Patricia in the eastern North Pacific deepened to a pressure of 872 mb. During a 1927 typhoon, the S.S. SAPOEROEA recorded a pressure of 886.6 mb, the lowest sea-level pressure reported from a ship. In Patricia, a pressure gradient of 24 mb per nautical mile was estimated from aircraft reconnaissance data.

In the absence of any information from an RSMC or TCWC, a method for alerting the mariner to possible tropical cyclone formation involves a statistical comparison of observed weather parameters with the climatology (30-year averaged conditions) for those parameters. Significant fluctuations away from these average conditions could mean the onset of severe weather. One such statistical method involves a comparison of mean surface pressure in the tropics with the standard deviation of surface pressure. Any significant deviation from the norm could indicate proximity to a tropical cyclone. Analysis shows that surface pressure can be expected to be lower than the mean minus 1 standard deviation less than 16% of the time, lower than the mean

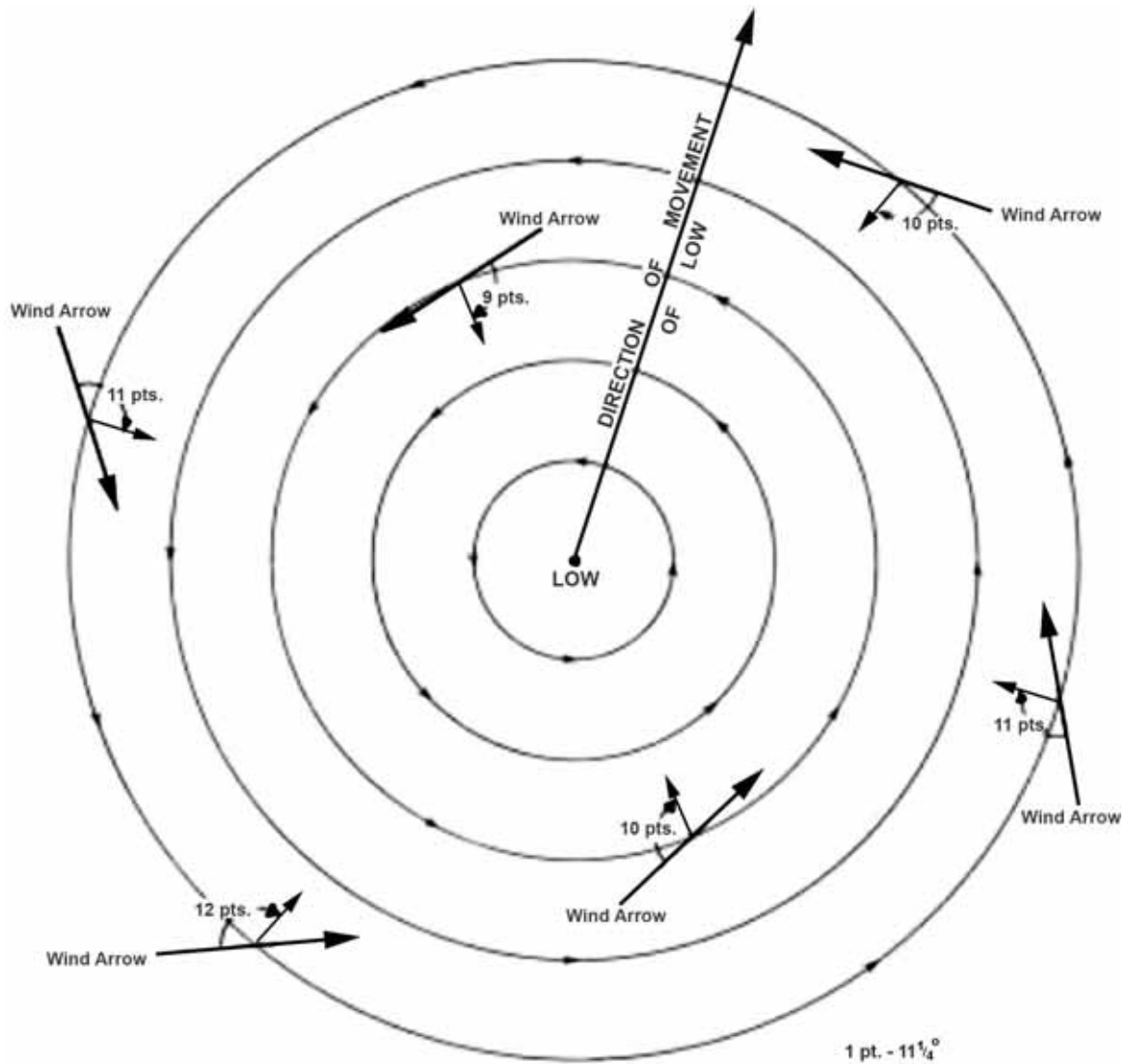

Figure 3913a. Approximate relationship of wind to isobars and storm center in the Northern Hemisphere.

minus 1.5 standard deviations less than 7% of the time, and lower than the mean minus 2 standard deviations less than 3% of the time. Comparison of the observed pressure with the mean will indicate how unusual the present conditions are.

As an example, assume the mean surface pressure in the South China Sea to be about 1005 mb during August with a standard deviation of about 2 mb. Therefore, surface pressure can be expected to fall below 1003 mb about 16% of the time and below 1000 mb about 7% of the time. Ambient pressure any lower than that would alert the mariner to the possible onset of heavy weather. Charts showing the mean surface pressure and the standard deviation of surface pressure for various global regions can be found in the U.S. Navy Marine Climatic Atlas of the World.

3915. Maneuvering to Avoid the Storm Center

The safest procedure with respect to tropical cyclones is to avoid them. If action is taken sufficiently early, this is simply a matter of setting a course that will take the vessel well to one side of the probable track of the storm, and then continuing to plot the positions of the storm center as given in the weather bulletins, revising the course as needed.

However, this is not always possible. If the ship is found to be within the storm area, the proper action to take depends in part upon its position relative to the storm center and its direction of travel. It is customary to divide the circular area of the storm into two parts.

In the Northern Hemisphere, that part to the right of the storm track (facing in the direction toward which the storm is moving) is called the dangerous semicircle. It is considered dangerous because (1) the actual wind speed is greater

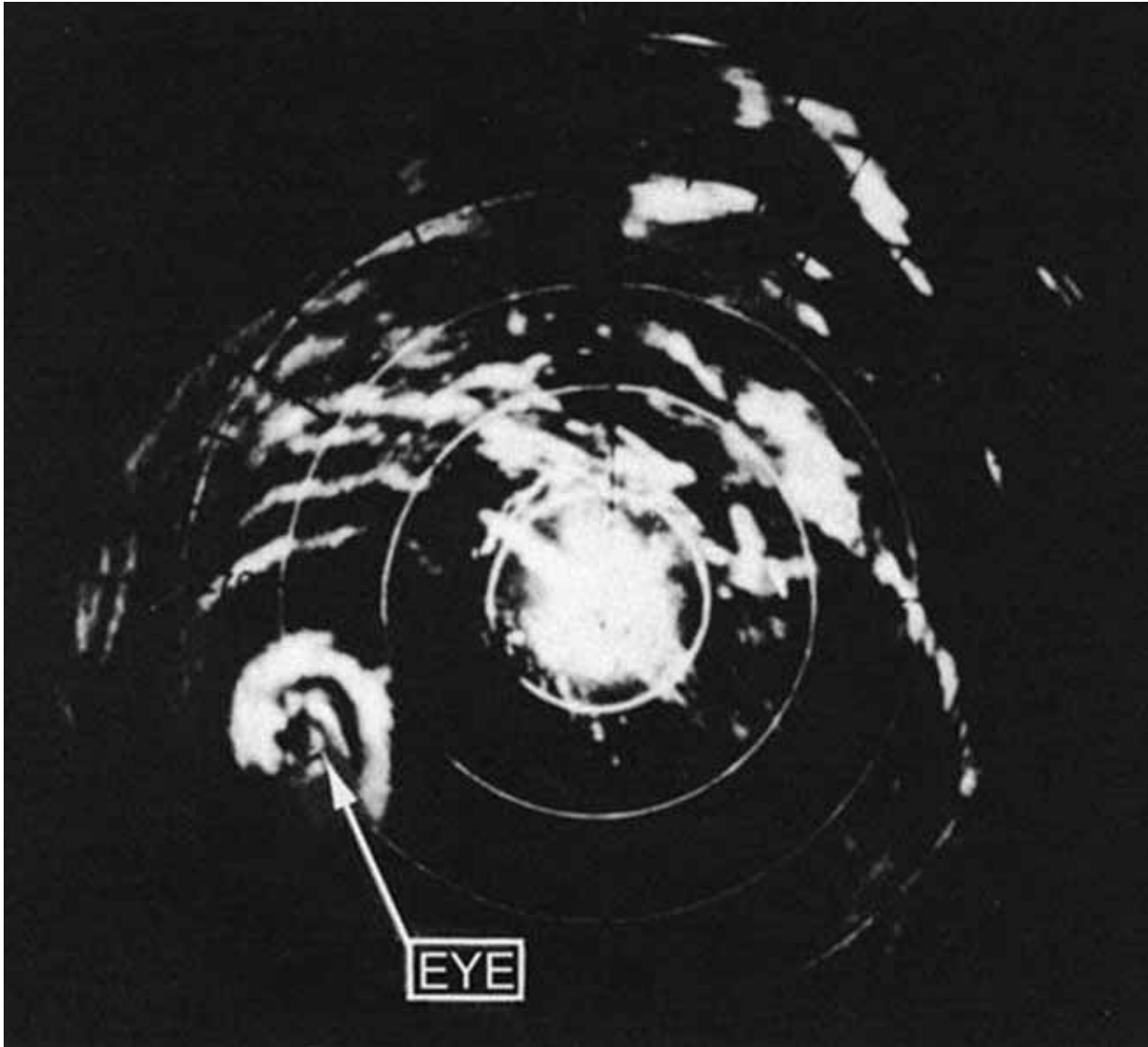

Figure 3913b. Radar PPI presentation of a tropical cyclone.

than that due to the pressure gradient alone, since it is augmented by the forward motion of the storm, and (2) the direction of the wind and sea is such as to carry a vessel into the path of the storm (in the forward part of the semicircle).

The part to the left of the storm track is called the less dangerous semicircle, or navigable semicircle. In this part, the wind is decreased by the forward motion of the storm, and the wind blows vessels away from the storm track (in the forward part). Because of the greater wind speed in the dangerous semicircle, the seas are higher than in the less dangerous semicircle. In the Southern Hemisphere, the dangerous semicircle is to the left of the storm track, and the less dangerous semicircle is to the right of the storm track.

A plot of successive positions of the storm center should indicate the semicircle in which a vessel is located. However, if this is based upon weather bulletins, it may not be a reliable guide because of the lag between the observa-

tions upon which the bulletin is based and the time of reception of the bulletin, with the ever-present possibility of a change in the direction of the storm. The use of radar eliminates this lag at short range, but the return may not be a true indication of the center. Perhaps the most reliable guide is the wind. Within the cyclonic circulation, a wind shifting to the right in the northern hemisphere and to the left in the southern hemisphere indicates the vessel is probably in the dangerous semicircle. A steady wind shift opposite to this indicates the vessel is probably in the less dangerous semicircle.

However, if a vessel is underway, its own motion should be considered. If it is outrunning the storm or pulling rapidly toward one side (which is not difficult during the early stages of a storm, when its speed is low), the opposite effect occurs. This should usually be accompanied by a rise in atmospheric pressure, but if motion of the vessel is nearly

along an isobar, this may not be a reliable indication. If in doubt, the safest action is usually to stop long enough to define the proper semicircle. The loss in time may be more than offset by the minimizing of the possibility of taking the wrong action, increasing the danger to the vessel. If the wind direction remains steady (for a vessel which is stopped), with increasing speed and falling barometer, the vessel is in or near the path of the storm. If it remains steady with decreasing speed and rising barometer, the vessel is near the storm track, behind the center.

The first action to take if the ship is within the cyclonic circulation is to determine the position of the vessel with respect to the storm center. While the vessel can still make considerable way through the water, a course should be selected to take it as far as possible from the center. If the vessel can move faster than the storm, it is a relatively simple matter to outrun the storm if sea room permits. But when the storm is faster, the solution is not as simple. In this case, the vessel, if ahead of the storm, will approach nearer to the center. The problem is to select a course that will produce the greatest possible minimum distance. This is best determined by means of a relative movement plot, as shown in the following example solved on a maneuvering board.

Example: A tropical cyclone is estimated to be moving in direction 320° at 19 knots. Its center bears 170° , at an estimated distance of 200 miles from a vessel which has a maximum speed of 12 knots.

Required:

- (1) The course to steer at 12 knots to produce the greatest possible minimum distance between the vessel and the storm center.
- (2) The distance to the center at nearest approach.
- (3) Elapsed time until nearest approach.

Solution: (Figure 3915a) Consider the vessel remaining

at the center of the plot throughout the solution, as on a radar PPI.

(1) To locate the position of the storm center relative to the vessel, plot point C at a distance of 200 miles (scale 20:1) in direction 170° from the center of the diagram. From the center of the diagram, draw RA, the speed vector of the storm center, in direction 320° , speed 19 knots (scale 2:1). From A draw a line tangent to the 12-knot speed circle (labeled 6 at scale 2:1) on the side opposite the storm center. From the center of the diagram, draw a perpendicular to this tangent line, locating point B. The line RB is the required speed vector for the vessel. Its direction, 011° , is the required course.

(2) The path of the storm center relative to the vessel will be along a line from C in the direction BA, if both storm and vessel maintain course and speed. The point of nearest approach will be at D, the foot of a perpendicular from the center of the diagram. This distance, at scale 20:1, is 187 miles.

(3) The length of the vector BA (14.8 knots) is the speed of the storm with respect to the vessel. Mark this on the lowest scale of the nomogram at the bottom of the diagram. The relative distance CD is 72 miles, by measurement. Mark this (scale 10:1) on the middle scale at the bottom of the diagram. Draw a line between the two points and extend it to intersect the top scale at 29.2 (292 at 10:1 scale). The elapsed time is therefore 292 minutes, or 4 hours 52 minutes.

Answers: (1) C 011° , (2) D 187 mi., (3) 4h 52m.

The storm center will be dead astern at its nearest approach.

As a general rule, for a vessel in the Northern Hemisphere, safety lies in placing the wind on the starboard bow in the dangerous semicircle and on the starboard quarter in the less dangerous semicircle. If on the storm track ahead of the storm, the wind should be put about 160° on the starboard quarter until the vessel is well within the less dangerous semicircle, and the rule for that semicircle then followed. In the Southern Hemisphere the same rules hold, but with respect to the port side. With a faster than average vessel, the wind can be brought a little farther aft in each case. However, as the speed of the storm increases along its track, the wind should be brought farther forward. If land interferes with what would otherwise be the best maneuver, the solution should be altered to fit the circumstances.

If the vessel is faster than the storm, it is possible to overtake it. In this case, the only action usually needed is to slow enough to let the storm pull ahead.

In all cases, one should be alert to changes in the direction of movement of the storm center, particularly in the area where the track normally curves toward the pole. If the storm maintains its direction and speed, the ship's course should be maintained as the wind shifts.

If it becomes necessary for a vessel to heave to, the characteristics of the vessel should be considered. A power vessel is concerned primarily with damage by direct action of the sea. A good general rule is to heave to with head to the sea in the dangerous semicircle, or stern to the sea in the less dangerous semicircle. This will result in greatest amount of headway away from the storm center, and least amount of leeway toward it. If a vessel handles better with the sea astern or on the quarter, it may be placed in this position in the less dangerous semicircle or in the rear half of the dangerous semicircle, but never in the forward half of the dangerous semicircle. It has been reported that when the wind reaches hurricane speed and the seas become confused, some ships ride out the storm best if the engines are stopped, and the vessel is left to seek its own position, or lie ahull. In this way, it is said, the ship rides with the storm instead of fighting against it.

In a sailing vessel attempting to avoid a storm center, one should steer courses as near as possible to those prescribed above for power vessels. However, if it

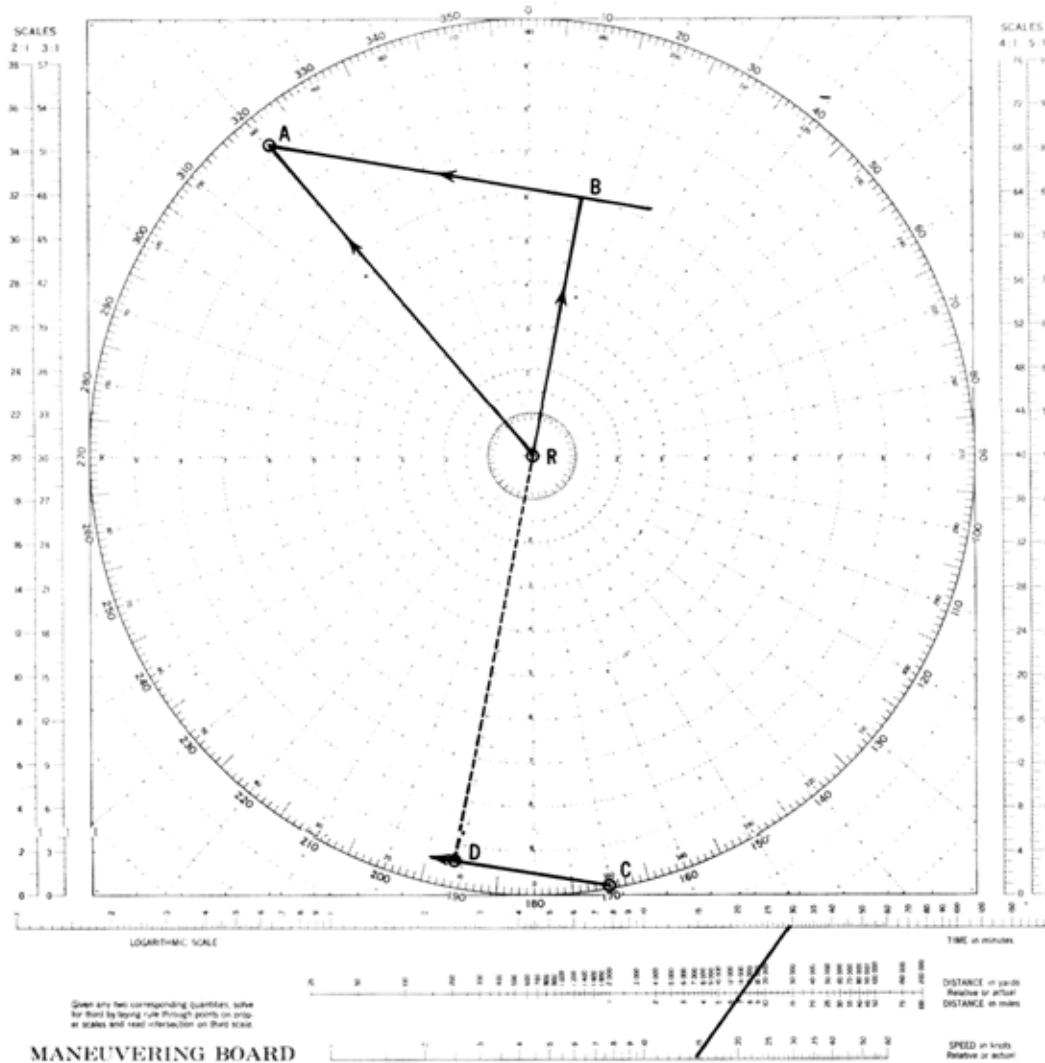

Figure 3915a. Determining the course to avoid the storm center.

becomes necessary for such a vessel to heave to, the wind is of greater concern than the sea. A good general rule always is to heave to on whichever tack permits the shifting wind to draw aft. In the Northern Hemisphere, this is the starboard tack in the dangerous semicircle, and the port tack in the less dangerous semicircle. In the Southern Hemisphere these are reversed.

While each storm requires its own analysis, and frequent or continual resurvey of the situation, the general rules for a steamer may be summarized as follows:

Northern Hemisphere

Right or dangerous semicircle: Bring the wind on the starboard bow (045° relative), hold course and make as much way as possible. If necessary, heave to with head to the sea.

Left or less dangerous semicircle: Bring the wind on

the starboard quarter (135° relative), hold course and make as much way as possible. If necessary, heave to with stern to the sea.

On storm track, ahead of center: Bring the wind 2 points on the starboard quarter (about 160° relative), hold course and make as much way as possible. When well within the less dangerous semicircle, maneuver as indicated above.

On storm track, behind center: Avoid the center by the best practicable course, keeping in mind the tendency of tropical cyclones to curve northward and eastward.

Southern Hemisphere

Left or dangerous semicircle: Bring the wind on the port bow (315° relative), hold course and make as much way as possible. If necessary, heave to with

head to the sea.

Right or less dangerous semicircle: Bring the wind on the port quarter (225° relative), hold course and make as much way as possible. If necessary, heave to with stern to the sea.

On storm track, ahead of center: Bring the wind about 200° relative, hold course and make as much way as possible. When well within the less dangerous semicircle, maneuver as indicated above.

On storm track, behind center: Avoid the center by the best practicable course, keeping in mind the tendency of tropical cyclones to curve southward and eastward.

It is possible, particularly in temperate latitudes after the storm has recurved, that the dangerous semicircle is the left one in the Northern Hemisphere (right one in the Southern Hemisphere). This can occur if a large high lies north of the storm and causes a tightening of the pressure gradient in the region.

The *Typhoon Havens Handbook* for the Western Pacific and Indian Oceans is published by the Naval Oceanographic and Atmospheric Research Lab

(NOARL) Monterey, California, as an aid to captains and commanding officers of ships in evaluating a typhoon situation, and to assist them in deciding whether to sortie, to evade, to remain in port, or to head for the shelter of a specific harbor. See Figure 3915b for a link to this handbook.



Figure 3915b. *Typhoon Havens Handbook*.
http://www.nrlmry.navy.mil/port_studies/thh-nc/0start.htm

3916. References

© Figure 3904 provided courtesy of University Corporation for Atmospheric Research (UCAR), COMINT Program, Boulder, CO 80301.

CHAPTER 40

WEATHER OBSERVATIONS

BASIC WEATHER OBSERVATIONS

4000. Introduction

Weather forecasts are based upon information acquired by observations made at a large number of stations. Ashore, these stations are located so as to provide adequate coverage of the area of interest. Observations at sea are made by mariners, buoys, and satellites. Since the number of observations at sea is small compared to the number ashore, marine observations are of great importance. Data recorded by designated vessels are sent by radio or satellite to national meteorological centers ashore, where they are calculated into computer forecast models for the development of synoptic charts. These models are then used to prepare local and global forecasts. The complete set of weather data gathered at sea is then sent to the appropriate meteorological services for use in the preparation of weather atlases and in marine climatological studies.

Weather observations are normally taken on the major synoptic hours (0000, 0600, 1200, and 1800 UTC). However, three-hourly intermediate observations are necessary on the Great Lakes, within 200 nautical miles from the United States or Canadian coastline, or within 300 nautical miles of a named tropical cyclone. Even with satellite imagery, actual reports are needed to confirm developing patterns and provide accurate temperature, pressure, and other measurements. Forecasts can be no better than the data received.

4001. Atmospheric Pressure

The sea of air surrounding the Earth exerts a pressure of about 14.7 pounds per square inch on the surface of the Earth. This **atmospheric pressure**, sometimes called **barometric pressure**, varies from place to place, and at the same place it varies over time.

Atmospheric pressure is one of the most basic elements of a meteorological observation. When the pressure at each station is plotted on a synoptic chart, lines of equal atmospheric pressure, called **isobars**, indicate the areas of high and low pressure. These are useful in making weather predictions because certain types of weather are characteristic of each type of area, and wind patterns over large areas can be deduced from the isobars.

Atmospheric pressure is measured with a **barometer**. The earliest known barometer was the **mercurial**

barometer, invented by Evangelista Torricelli in 1643. In its simplest form, it consists of a glass tube a little more than 30 inches in length and of uniform internal diameter. With one end closed, the tube is filled with mercury, and inverted into a cup of mercury. The mercury in the tube falls until the column is just supported by the pressure of the atmosphere on the open cup, leaving a vacuum at the upper end of the tube. The height of the column indicates atmospheric pressure, with greater pressures supporting higher columns of mercury.

The **aneroid barometer** has a partly evacuated, thin metal cell which is compressed by atmospheric pressure. Slight changes in air pressure cause the cell to expand or contract, while a system of levers magnifies and converts this motion to a reading on a gauge or recorder.

Early mercurial barometers were calibrated to indicate the height, usually in inches or millimeters, of the column of mercury needed to balance the column of air above the point of measurement. While units of inches and millimeters are still widely used, many modern barometers are calibrated to indicate the centimeter-gram-second unit of pressure, the **hectopascal (hPa)**, formerly known as the millibar. The hectopascal is equal to 1,000 dynes per square centimeter. A **dyne** is the force required to accelerate a mass of one gram at the rate of one centimeter per second per second. $1,000 \text{ hPa} = 100,000 \text{ Pascal} = 14.50 \text{ pounds per square inch} = 750.0 \text{ mm Hg} = 0.9869 \text{ atmosphere}$. A reading in any of the three units of measurement can be converted to the equivalent reading in any of the other units by using the Conversion Table for hecto-Pascals (millibars), Inches of Mercury, and Millimeters of Mercury (Table 34) or the conversion factors. However, the pressure reading should always be reported in hPa.

4002. The Aneroid Barometer

The **aneroid barometer** (Figure 4002a) measures the force exerted by atmospheric pressure on a partly evacuated, thin metal element called a **syphon cell** or aneroid capsule. A small spring is used, either internally or externally, to partly counteract the tendency of the atmospheric pressure to crush the cell. Atmospheric pressure is indicated directly by a scale and a pointer connected to the cell by a combination of levers. The linkage provides considerable magnification of the slight motion of the cell, to permit



Figure 4002a. An aneroid barometer.

readings to higher precision than could be obtained without it. An aneroid barometer should be mounted permanently. Prior to installation, the barometer should be carefully set. U.S. ships of the **Voluntary Observation Ship (VOS)** program are set to sea level pressure. Other vessels may be set to station pressure and corrected for height as necessary. An adjustment screw is provided for this purpose. The error of this instrument is determined by comparison with a mercurial barometer, Digiquartz barometer, or a standard precision aneroid barometer. If a qualified meteorologist is not available to make this adjustment, adjust by first removing only one half the apparent error. Then tap the case gently to assist the linkage to adjust itself, and repeat the adjustment. If the remaining error is not more than half a hPa (0.015 inch), no attempt should be made to remove it by further adjustment. Instead, a correction should be applied to the readings. The accuracy of this correction should be checked from time to time.

More information regarding the Voluntary Observation Ship (VOS) program can be accessed via the link provided in Figure 4002b.

4003. The Barograph

The **barograph** (Figure 4003) is a recording barometer. In principle it is the same as a non-recording



Figure 4002b. Voluntary Observation Ship (VOS) Program. <https://www.vos.noaa.gov/>

aneroid barometer except that the pointer carries a pen at its outer end, and a slowly rotating cylinder around which a chart is wrapped replaces the scale. A clock mechanism inside the cylinder rotates it so that a continuous line is traced on the chart to indicate the pressure at any time. The barograph is usually mounted on a shelf or desk in a room open to the atmosphere and in a location which minimizes the effect of the ship's vibration. Shock absorbing material such as sponge rubber may be placed under the instrument to minimize vibration. The pen should be checked each time the chart is changed.

A **marine microbarograph** is a precision barograph using greater magnification and an expanded chart. It is designed to maintain its precision through the conditions encountered aboard ship. Two siphon cells are used, one



Figure 4003. A marine barograph.

mounted over the other, in tandem. Minor fluctuations due to shocks or vibrations are eliminated by damping. Since oil filled dashpots are used for this purpose, the instrument should never be inverted. The dashpots of the marine microbarograph should be kept filled with dashpot oil to within three-eighths inch of the top. The marine microbarograph is fitted with a valve so it can be vented to the outside for more accurate pressure readings.

Ship motions are compensated by damping and spring loading which make it possible for the microbarograph to be tilted up to 22° without varying more than 0.3 hPa from the true reading. Microbarographs have been almost entirely replaced by standard barographs.

Both instruments require checking from time to time to insure correct indication of pressure. The position of the pen is adjusted by a small knob provided for this purpose. The adjustment should be made in stages, eliminating half the apparent error, tapping the case to insure linkage adjustment to the new setting, and then repeating the process.

4004. Adjusting Barometer Readings

Atmospheric pressure as indicated by a barometer or barograph may be subject to several errors.

Instrument error: Inaccuracy due to imperfection or incorrect adjustment can be determined by comparison with a standard precision instrument. The National Weather Service provides a comparison service. In major U.S. ports, a **Port Meteorological Officer (PMO)** carries a portable

precision aneroid barometer or a digital barometer for barometer comparisons on board ships which participate in the VOS program. The portable barometer is compared with station barometers before and after a ship visit. If a barometer is taken to a National Weather Service shore station, the comparison can be made there. The correct sea level pressure can also be obtained by telephone. The shipboard barometer should be corrected for height, as explained below, before comparison with this value. If there is reason to believe that the barometer is in error, it should be compared with a standard, and if an error is found, the barometer should be adjusted to the correct reading, or a correction applied to all readings. More information regarding PMOs is available via the link provided in Figure 4004.



Figure 4004. Link to Port Meteorological Officers website.
https://www.vos.noaa.gov/met_officers.shtml

Height error: The atmospheric pressure reading at the height of the barometer is called the **station pressure** and is subject to a height correction in order to correct it to sea

level. Isobars adequately reflect wind conditions and geographic distribution of pressure only when they are drawn for pressure at constant height (or the varying height at which a constant pressure exists). On synoptic charts it is customary to show the equivalent pressure at sea level, called **sea level pressure**. This is found by applying a correction to station pressure. The correction depends upon the height of the barometer and the average temperature of the air between this height and the surface. The outside air temperature taken aboard ship is sufficiently accurate for this purpose and is an important correction that should be applied to all readings of any type of barometer. See the Correction of Barometer Reading for Height Above Sea Level table (Table 31) for this correction. Of special note on the Great Lakes, each Lake is at a different height above sea level, so an additional correction is needed.

Temperature error: Barometers are calibrated at a standard temperature of 32°F. Modern aneroid barometers compensate for temperature changes by using different metals having unequal coefficients of linear expansion.

4005. Temperature

Temperature is a measure of heat energy, measured in degrees. Several different temperature scales are in use.

On the **Fahrenheit (F)** scale, pure water freezes at 32° and boils at 212°.

On the **Celsius (C)** scale, commonly used with the metric system, the freezing point of pure water is 0° and the boiling point is 100°. This scale has been known by various names in different countries. In the United States it was formerly called the centigrade scale. The Ninth General Conference of Weights and Measures, held in France in 1948, adopted the name Celsius to be consistent with the naming of other temperature scales after their inventors, and to avoid the use of different names in different countries. On the original Celsius scale, invented in 1742 by a Swedish astronomer named Anders Celsius, numbering was the reverse of the modern scale, 0° representing the boiling point of water, and 100° its freezing point.

Temperature of one scale can be easily converted to another because of the linear mathematical relationship between them. Note that the sequence of calculation is slightly different; algebraic rules must be followed.

$$C = \frac{5}{9}(F - 32), \text{ or } C = \frac{F - 32}{1.8}$$

$$F = \frac{9}{5}C + 32, \text{ or } F = 1.8C + 32$$

$$K \text{ (Kelvin)} = C + 273.15$$

$$R \text{ (Rankine)} = F + 459.69$$

A temperature of -40° is the same by either the Celsius or Fahrenheit scale. Similar formulas can be made for

conversion of other temperature scale readings. The Conversion Table for Thermometer Scales (Table 29) gives the equivalent values of Fahrenheit, Celsius, and Kelvin temperatures.

The intensity or degree of heat (temperature) should not be confused with the amount of heat. If the temperature of air or some other substance is to be increased by a given number of degrees, the amount of heat that must be added depends on the mass of the substance. Also, because of differences in their specific heat, equal amounts of different substances require the addition of unequal amounts of heat to raise their temperatures by equal amounts. The units used for measurement of heat are the **British thermal unit (BTU)**, the amount of heat needed to raise the temperature of 1 pound of water 1° Fahrenheit, and the **calorie**, the amount of heat needed to raise the temperature of 1 gram of water 1° Celsius.

4006. Temperature Measurement

Temperature is measured with a **thermometer**. Most thermometers are based upon the principle that materials expand with an increase of temperature, and contract as temperature decreases. In its most common form, a thermometer consists of a bulb filled with mercury or a glycol based fluid, which is connected to a tube of very small cross sectional area. The fluid only partly fills the tube. In the remainder is a vacuum. Air is driven out by boiling the fluid, and the top of the tube is then sealed. As the fluid expands or contracts with changing temperature, the length of the fluid column in the tube changes.

Sea surface temperature observations are used in the forecasting of fog and furnish important information about the development and movement of tropical cyclones. Commercial fishermen are interested in the sea surface temperature as an aid in locating certain species of fish. There are several methods of determining seawater temperature. These include engine room intake readings, condenser intake readings, thermistor probes attached to the hull, and readings from buckets recovered from over the side. Although the condenser intake method is not a true measure of surface water temperature, the error is generally small.

If the surface temperature is desired, a sample should be obtained by bucket, preferably made of canvas, from a forward position well clear of any discharge lines. The sample should be taken immediately to a place where it is sheltered from wind and Sun. The water should then be stirred with the thermometer, keeping the bulb submerged, until a constant reading is obtained.

A considerable variation in sea surface temperature can be experienced in a relatively short distance of travel. This is especially true when crossing major ocean currents such as the Gulf Stream and the Kuroshio Current. Significant variations also occur where large quantities of fresh water are discharged from rivers or bays. A clever navigator will note these changes as an indication of when to allow for set

and drift in dead reckoning.

4007. Humidity

Humidity is a measure of the atmosphere's water vapor content. **Relative humidity** is the ratio, stated as a percentage, of the pressure of water vapor present in the atmosphere to the saturation vapor pressure at the same temperature.

As air temperature decreases, the relative humidity increases, as long as the wet-bulb temperature remains the same or decreases at a slower rate than air temperature. At some point, saturation takes place, and any further cooling results in condensation of some of the moisture. The temperature at which this occurs is called the dew point, and the moisture deposited upon objects is called dew if it forms in the liquid state, or frost if it forms as ice crystals.

The same process causes moisture to form on the outside of a container of cold liquid, the liquid cooling the air in the immediate vicinity of the container until it reaches the dew point. When moisture is deposited on man-made objects, it is sometimes called **sweat**. It occurs whenever the temperature of a surface is lower than the dew point of air in contact with it. It is of particular concern to the mariner because of its effect upon instruments, and possible damage to ship or cargo. Lenses of optical instruments may sweat, usually with such small droplets that the surface has a "frosted" appearance. When this occurs, the instrument is said to "fog" or "fog up," and is useless until the moisture is removed. Damage is often caused by corrosion or direct water damage when pipes or inner shell plates of a vessel sweat and drip. Cargo may also sweat if it is cooler than the dew point of the air.

Clouds and fog form from the condensation of water on minute particles of dust, salt, and other material in the air. Each particle forms a nucleus around which a droplet of water forms. If air is completely free from solid particles on which water vapor may condense, the extra moisture remains vaporized, and the air is said to be **supersaturated**.

Relative humidity and dew point are measured with a **hygrometer**. The most common type, called a **psychrometer**, consists of two thermometers mounted together on a single strip of material. One of the thermometers is mounted a little lower than the other, and has its bulb covered with muslin. When the muslin covering is thoroughly moistened and the thermometer well ventilated, evaporation cools the bulb of the thermometer, causing it to indicate a lower reading than the other. A **sling psychrometer** is ventilated by whirling the thermometers. The difference between the dry-bulb and wet-bulb temperatures is used to enter **psychrometric tables** (Relative Humidity and Dew Point Tables) (Table 35 and Table 36) to find the relative humidity and dew point. If the wet-bulb temperature is above freezing, reasonably accurate results can be obtained by a psychrometer consisting of dry- and wet-bulb thermometers mounted so that air can circulate freely around them without

special ventilation. This type of installation is common aboard ship.

***Example:** The dry-bulb temperature is 65°F, and the wet-bulb temperature is 61°F.*

***Required:** (1) Relative humidity, (2) dew point.*

***Solution:** The difference between readings is 4°. Entering the Relative Humidity Table (Table 35) with this value, and a dry-bulb temperature of 65°, the relative humidity is found to be 80%. From the Dew Point Table (Table 36) the dew point is 58°.*

***Answers:** (1) Relative humidity 80 percent, (2) dew point 58°.*

Also in use aboard many ships is the **electric psychrometer**. This is a hand held, battery operated instrument with two mercury thermometers for obtaining dry- and wet-bulb temperature readings. It consists of a plastic housing that holds the thermometers, batteries, motor, and fan.

4008. Wind Measurement

Wind measurement consists of determination of the direction and speed of the wind. Direction is measured by a **wind vane**, and speed by an **anemometer**. Several types of wind speed and direction sensors are available, using vanes to indicate wind direction (where the wind is coming from) and rotating cups or propellers for speed sensing. Many ships have reliable wind instruments installed, and inexpensive wind instruments are available for even the smallest yacht. If no anemometer is available, wind speed can be estimated by its effect upon the sea and nearby objects. The direction can be computed accurately, even on a fast moving vessel, by maneuvering board or using the Direction and Speed of True Wind in Units of Ship's Speed Table (Table 30).

4009. True and Apparent Wind

An observer aboard a vessel proceeding through still air experiences an apparent wind which is from dead ahead and has an apparent speed equal to the speed of the vessel. Thus, if the actual or true wind is zero and the speed of the vessel is 10 knots, the apparent wind is from dead ahead at 10 knots. If the true wind is from dead ahead at 15 knots, and the speed of the vessel is 10 knots, the apparent wind is $15 + 10 = 25$ knots from dead ahead. If the vessel reverses course, the apparent wind is $15 - 10 = 5$ knots, from dead astern.

The **apparent wind** is the vector sum of the true wind and the *reciprocal* of the vessel's course and speed vector. Since wind vanes and anemometers measure apparent wind, the usual problem aboard a vessel equipped with an anemometer is to convert apparent wind to true wind. There are several ways of doing this. Perhaps the simplest is by the graphical solution illustrated in the fol-

lowing example:

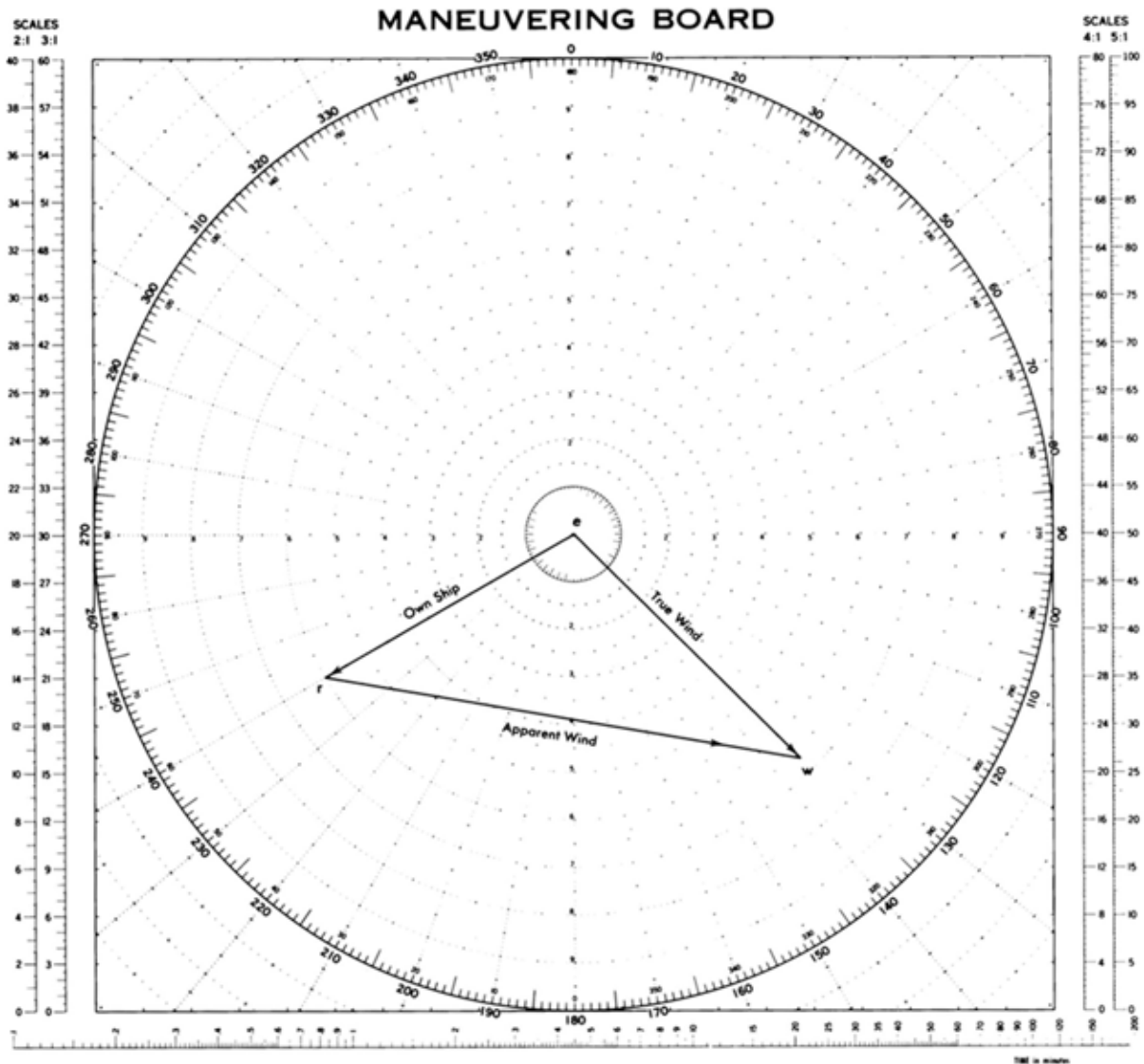

Figure 4009a. Finding true wind by Maneuvering Board.

Example 1: A ship is proceeding on course 240° at a speed of 18 knots. The apparent wind is from 040° relative at 30 knots.

Required: The direction and speed of the true wind.

Solution: (Figure 4009a) First starting from the center of a maneuvering board, plot the ship's vector "er," at 240° , length 18 knots (using the 3-1 scale). Next plot the relative wind's vector from r, in a direction of 100° (the reciprocal of 280°) length 30 knots. The true wind is from the center to the end of this vector or line "ew."

Alternatively, you can plot the ship's vector from the center, then plot the relative wind's vector toward the center, and see the true wind's vector from the end of this line to the end of the ship's vector. Use parallel rulers to

transfer the wind vector to the center for an accurate reading.

Answer: True wind is from 315° at 20 knots.

On a moving ship, the direction of the true wind is always on the same side and aft of the direction of the apparent wind. The faster the ship moves, the more the apparent wind draws ahead of the true wind.

A solution can also be made in the following manner without plotting: On a maneuvering board, label the circles 5, 10, 15, 20, etc., from the center, and draw vertical lines tangent to these circles. Cut out the 5:1 scale and discard that part having graduations greater than the maximum speed of the vessel. Keep this sheet for all solutions. (For durability,

the two parts can be mounted on cardboard or other suitable material.) To find true wind, spot in point 1 by eye. Place the zero of the 5:1 scale on this point and align the scale (inverted) using the vertical lines. Locate point 2 at the speed of the vessel as indicated on the 5:1 scale. It is always vertically below point 1. Read the relative direction and the speed of the true wind, using eye interpolation if needed.

A tabular solution can be made using the Direction and Speed of True Wind in Units of Ship's Speed table (Table 30). The entering values for this table are the apparent wind speed in units of ship's speed, and the difference between the heading and the apparent wind direction. The values taken from the table are the relative direction (right or left) of the true wind, and the speed of the true wind in units of ship's speed. If a vessel is proceeding at 12 knots, 6 knots constitutes one-half (0.5) unit, 12 knots one unit, 18 knots 1.5 units, 24 knots two units, etc.

Example 2: A ship is proceeding on course 270° at a speed of 10 knots. The apparent wind is from 10° off the port bow, speed 30 knots.

Required: The relative direction, true direction, and speed of the true wind by table.

Solution: The apparent wind speed is

$$\frac{30}{10} = 3.0 \text{ ships speed units}$$

Enter the Direction and Speed of True Wind in Units of Ship's Speed table (Table 30) with 3.0 and 10° and find the relative direction of the true wind to be 15° off the port bow (345° relative), and the speed to be 2.02 times the ship's speed,

or 20 knots, approximately. The true direction is $345^\circ + 270^\circ (-360) = 255^\circ$.

Answers: True wind from 345° relative = 255° true, at 20 knots.

One can also find apparent wind from the true wind, course or speed required to produce an apparent wind from a given direction or speed, or course and speed to produce an apparent wind of a given speed from a given direction. Such problems often arise in aircraft carrier operations and in some rescue situations. Printable maneuvering board files are available through the link provided in Figure 4009b.



Figure 4009b. Link to Pub 1310, The Radar Navigation and Maneuvering Board Manual.

https://msi.nga.mil/NGAPortal/MSI.portal?_nfpb=true&_st=&_pageLabel=msi_portal_page_62&pubCode=0008

When wind speed and direction are determined by the appearance of the sea, the result is true speed and direction. Waves move in the same direction as the generating wind, and are not deflected by Earth's rotation. If a wind vane is used, the direction of the apparent wind thus determined can be used with the speed of the true wind to determine the direction of the true wind by vector diagram.

WIND AND WAVES

4010. Effects of Wind on the Sea

There is a direct relationship between the speed of the wind and the state of the sea. This is useful in predicting the sea conditions to be anticipated when future wind speed forecasts are available. It can also be used to estimate the speed of the wind, which may be necessary when an anemometer is not available.

Wind speeds are usually grouped in accordance with the **Beaufort Scale of Wind Force**, devised in 1806 by English Admiral Sir Francis Beaufort (1774-1857). As adopted in 1838, Beaufort numbers ranged from 0 (calm) to 12 (hurricane). The Beaufort wind scale and sea state photographs at the end of this chapter can be used to estimate wind speed (also see Table 4012). With the exception of Force 12, contributed by John Thomson of Ponteland, Northumberland, England, these pictures (courtesy of the Meteorological Service of Canada) represent the results of a project carried out on board the Canadian Ocean Weather Ships VANCOUVER and

QUADRA at Ocean Weather Station PAPA (50°N, 145°W), between April 1976 and May 1981. The aim of the project was to collect color photographs of the sea surface as it appears under the influence of the various ranges of wind speed, as defined by The Beaufort Scale. The photographs represent as closely as possible steady state sea conditions over many hours for each Beaufort wind force. They were taken from heights ranging from 12-17 meters above the sea surface; anemometer height was 28 meters.

4011. Estimating the Wind at Sea

When there is not a functioning anemometer, observers on board ships will usually determine the speed of the wind by estimating Beaufort force. Through experience, ships' officers have developed various methods of estimating this force. The effect of the wind on the observer, the ship's rigging, flags, etc., is used as a guide, but estimates based on these indications give the relative wind which must be corrected for the motion of the ship before an estimate of the

true wind speed can be obtained.

The most common method involves the appearance of the sea surface. The state of the sea disturbance, i.e. the dimensions of the waves, the presence of white caps, foam, or spray, depends principally on three factors:

1. **The wind speed.** The higher the speed of the wind, the greater is the sea disturbance.
2. **The wind's duration.** At any point on the sea, the disturbance will increase the longer the wind blows at a given speed, until a maximum state of disturbance is reached.
3. **The fetch.** This is the length of the stretch of water over which the wind acts on the sea surface from the same direction.

For a given wind speed and duration, the longer the fetch, the greater is the sea disturbance. If the fetch is short, such as a few miles, the disturbance will be relatively small no matter how great the wind speed is or how long it has been blowing.

Swell waves are not considered when estimating wind speed and direction. Only those waves raised by the wind blowing at the time are of any significance.

A wind of a given Beaufort force will, therefore, produce a characteristic appearance of the sea surface provided that it has been blowing for a sufficient length of

time, and over a sufficiently long fetch.

In practice, the mariner observes the sea surface, noting the size of the waves, the white caps, spindrift, etc., and then finds the criterion which best describes the sea surface as observed. This criterion is associated with a Beaufort number, for which a corresponding mean wind speed and range in knots are given. Since meteorological reports require that wind speeds be reported in knots, the mean speed for the Beaufort number may be reported, or an experienced observer may judge that the sea disturbance is such that a higher or lower speed within the range for the force is more accurate.

This method should be used with caution. The sea conditions described for each Beaufort force are "steady-state" conditions; i.e. the conditions which result when the wind has been blowing for a relatively long time, and over a great stretch of water. However, at any particular time at sea the duration of the wind or the fetch, or both, may not have been great enough to produce these "steady-state" conditions. When a high wind springs up suddenly after previously calm or near calm conditions, it will require some hours, depending on the strength of the wind, to generate waves of maximum height. The height of the waves increases rapidly in the first few hours after the commencement of the blow, but increases at a much slower rate later on.

Beaufort force of wind.	Theoretical maximum wave height (ft) unlimited duration and fetch.	Duration of winds (hours), with unlimited fetch, to produce percent of maximum wave height indicated.			Fetch (nautical miles), with unlimited duration of blow, to produce percent of maximum wave height indicated.		
		50%	75%	90%	50%	75%	90%
3	2	1.5	5	8	3	13	25
5	8	3.5	8	12	10	30	60
7	20	5.5	12	21	22	75	150
9	40	7	16	25	55	150	280
11	70	9	19	32	85	200	450

Table 4011. Duration of winds and length of fetches required for various wind forces.

At the beginning of the fetch (such as at a coastline when the wind is offshore) after the wind has been blowing for a long time, the waves are quite small near shore, and increase in height rapidly over the first 50 miles or so of the fetch. Farther offshore, the rate of increase in height with distance slows down, and after 500 miles or so from the beginning of the fetch, there is little or no increase in height.

Table 4011 illustrates the duration of winds and the length of fetches required for various wind forces to build

seas to 50 percent, 75 percent, and 90 percent of their theoretical maximum heights.

The theoretical maximum wave heights represent the average heights of the highest third of the waves, as these waves are most significant.

It is clear that winds of force 5 or less can build seas to 90 percent of their maximum height in less than 12 hours, provided the fetch is long enough. Higher winds require a much greater time, force 11 winds requiring 32 hours to build waves

to 90 percent of their maximum height. The times given in Table 4011 represent those required to build waves starting from initially calm sea conditions. If waves are already present at the onset of the blow, the times would be somewhat less, depending on the initial wave heights and their direction relative to the direction of the wind which has sprung up.

The first consideration when using the sea criterion to estimate wind speed, therefore, is to decide whether the wind has been blowing long enough from the same direction to produce a steady state sea condition. If not, then it is possible that the wind speed may be underestimated.

Experience has shown that the appearance of whitecaps, foam, spindrift, etc. reaches a steady state condition before the height of the waves attain their maximum value. It is a safe assumption that the appearance of the sea (such as white-caps, etc.) will reach a steady state in the time required to build the waves to 50-75 percent of their maximum height. Thus, from Table 4011 it is seen that a force 5 wind could require 8 hours at most to produce a characteristic appearance of the sea surface.

A second consideration when using the sea criteria is the amount of the fetch over which the wind has been blowing to produce the present state of the sea. On the open sea, unless the mariner has the latest synoptic weather map available, the length of the fetch will not be known. It will be seen from Table 4011 though, that only relatively short fetches are required for the lower wind forces to generate their characteristic seas. On the open sea, the fetches associated with most storms and other weather systems are usually long enough so that even winds up to force 9 can build seas up to 90 percent or more of their maximum height, providing the wind blows from the same direction long enough.

When navigating close to a coast or in restricted waters, however, it may be necessary to make allowances for the shorter stretches of water over which the wind blows. For example, referring to Table 4011, if the ship is 22 miles from a coast, and an offshore wind with an actual speed of force 7 is blowing, the waves at the ship will never attain more than 50 percent of their maximum height for this speed no matter how long the wind blows. Hence, if the sea criteria were used under these conditions without consideration of the short fetch, the wind speed would be underestimated. With an offshore wind, the sea criteria may be used with confidence if the distance to the coast is greater than the values given in the extreme right-hand column of Table 4011, provided that the wind has been blowing offshore for a sufficient length of time.

4012. Wind Speed Calculating Factors

Tidal and Other Currents: A wind blowing against the tide or a strong non-tidal current causes higher, steeper waves having a shorter period than normal, which may result in an overestimate of the wind speed if the estimation is made by wave height alone. On the other hand, a wind blowing in the same direction as a tide or strong current causes less sea

disturbance than normal, with longer period waves, which may result in underestimating the wind speed.

Shallow Water: Waves running from deep water into shallow water increase in steepness, hence their tendency to break. Therefore, with an onshore wind there will naturally be more whitecaps over shallow waters than over the deeper water farther offshore. It is only over relatively deep water that the sea criteria can be used with confidence.

Swell: Swell is the name given to waves, generally of considerable length, which were raised in some distant area and which have moved into the vicinity of the ship, or to waves raised nearby that continue after the wind has abated or changed direction. The direction of swell waves is usually different from the direction of the wind and the sea waves. Swell waves are not considered when estimating wind speed and direction. Only those waves raised by the wind blowing at the time are used for estimation. The wind-driven waves show a greater tendency to break when superimposed on the crests of swell, and hence, more whitecaps may be formed than if the swell were absent. Under these conditions, the use of the sea criteria may result in a slight overestimate of the wind speed.

Precipitation: Heavy rain has a damping or smoothing effect on the sea surface that is mechanical in character. Since the sea surface will therefore appear less disturbed than would be the case without the rain, the wind speed may be underestimated unless the smoothing effect is taken into account.

Ice: Even small concentrations of ice floating on the sea surface will dampen waves considerably, and concentrations averaging greater than about seven-tenths will eliminate waves altogether. Young sea ice, which in the early stages of formation has a thick soupy consistency and later takes on a rubbery appearance, is very effective in dampening waves. Consequently, the sea criteria cannot be used with any degree of confidence when sea ice is present. In higher latitudes, the presence of an ice field some distance to windward of the ship may be suspected if, when the ship is not close to any coast, the wind is relatively strong but the seas abnormally underdeveloped. The edge of the ice field acts like a coastline, and the short fetch between the ice and the ship is not sufficient for the wind to fully develop the seas.

Wind Shifts: Following a rapid change in the direction of the wind, as occurs at the passage of a cold front, the new wind will flatten out to a great extent the waves which were present before the wind shift. This happens because the direction of the wind after the shift may differ by 90° or more from the direction of the waves, which does not change. Hence, the wind may oppose the progress of the waves and quickly dampen them out. At the same time, the new wind begins to generate its own waves on top of this dissipating swell, and it is not long before the cross pattern of waves gives the sea a "choppy" or confused appearance. It is during the first few hours following the wind shift that the

appearance of the sea surface may not provide a reliable indication of wind speed. The wind is normally stronger than the sea would indicate, as old waves are being flattened out, and the new wave pattern develops.

Night Observations: On a dark night, when it is impossible to see the sea clearly, the observer may estimate

the apparent wind from its effect on the ship's rigging, flags, etc., or simply the "feel" of the wind.

Wind Scales and Sea Codes: Table 4012 contains descriptions for the Beaufort wind scale and corresponding sea state codes.

Beaufort Wind Scale with Corresponding Sea Codes						
Beaufort Number	Wind Velocity (knots)	Wind Velocity (mph)	Wind Description	Sea State Description	Sea State	
					Term and Height of Waves (feet)	Condition Number
0	< 1	< 1	Calm	Sea surface smooth and mirror-like	Calm, glassy 0	0
1	1-3	1-3	Light Air	Scaly ripples, no foam crests		
2	4-6	4-7	Light Breeze	Small wavelets, crests glassy, no breaking	Calm, rippled 0 - 0.3	1
3	7-10	8-12	Gentle Breeze	Large wavelets, crests begin to break, scattered whitecaps	Smooth, wavelets 0.3 - 1	2
4	11-16	13-18	Moderate Breeze	Small waves, becoming longer, numerous whitecaps	Slight 1- 4	3
5	17-21	19-24	Fresh Breeze	Moderate waves, taking longer form, many whitecaps, some spray	Moderate 4 - 8	4
6	22-27	25-31	Strong Breeze	Larger waves, whitecaps common, more spray	Rough 8 - 13	5
7	28-33	32-38	Near Gale	Sea heaps up, white foam steaks off breakers	Very rough 13 - 20	6
8	34-40	39-46	Gale	Moderately high, waves of greater length, edges of crests begin to break into spindrift, foam blown in streaks		
9	41-47	47-54	Strong Gale	High waves, sea begins to roll, dense streaks of foam, spray may reduce visibility		
10	48-55	55-63	Storm	Very high waves, with overhanging crests, sea white with densely blown foam, heavy rolling, lowered visibility	High 20 - 30	7
11	59-63	64-72	Violent Storm	Exceptionally high waves, foam patches cover sea, visibility more reduced	Very high 30 - 45	8
12	64 and over	73 and over	Hurricane	Air filled with foam, sea completely white with driving spray, visibility greatly reduced	Phenomenal 45 and over	9

Table 4012. Beaufort wind scale with corresponding sea codes.

CLOUDS

4013. Cloud Formation

Clouds consist of innumerable tiny droplets of water, or ice crystals, formed by condensation of water vapor around microscopic particles in the air. **Fog** is a cloud in contact with the surface of the Earth.

The shape, size, height, thickness, and nature of a cloud all depend upon the conditions under which it is formed. Therefore, clouds are indicators of various processes occurring in the atmosphere. The ability to recognize different

types, and a knowledge of the conditions associated with them, are useful in predicting future weather (see Figure 4013b).

Although the variety of clouds is virtually endless, they may be classified by type. Clouds are grouped into three families according to common characteristics and the altitude of their bases. The families are High, Middle, and Low clouds. As shown in Table 4013a, the altitudes of the cloud bases vary depending on the latitude in which they are located. Large temperature changes cause most of this

latitudinal variation.

Cloud Group	Tropical Regions	Temperate Regions	Polar Regions
High	6,000 to 18,000m (20,000 to 60,000ft)	5,000 to 13,000m (16,000 to 43,000ft)	3,000 to 8,000m (10,000 to 26,000ft)
Middle	2,000 to 8,000m (6,500 to 26,000ft)	2,000 to 7,000m (6,500 to 23,000ft)	2,000 to 4,000m (6,500 to 13,000ft)
Low	surface to 2,000m (0 to 6,500ft)	surface to 2,000m (0 to 6,500ft)	surface to 2,000m (0 to 6,500ft)

Table 4013a. Approximate height of cloud bases above the surface for various locations

High clouds are composed principally of ice crystals. As shown in Table 4013a, the air temperatures in the tropic regions that are low enough to freeze all liquid water usually occur above 6000 meters, but in the polar regions these temperatures are found at altitudes as low as 3000 meters. **Middle clouds** are composed largely of water droplets, although higher ones have a tendency toward ice particles. **Low clouds** are composed entirely of water droplets. Clouds types cannot be sufficiently distinguished just by their base altitudes, so within these 3 families are 10 principal cloud types. The names of these are composed of various combinations and forms of the following basic

words, all from Latin:

- Cirrus**, meaning “curl, lock, or tuft of hair.”
- Alto**, meaning “high, upper air.”
- Stratus**, meaning “spread out, flatten, cover with a layer.”
- Cumulus**, meaning “heap, a pile, an accumulation.”
- Nimbus**, meaning “rainy cloud.”

Individual cloud types recognize certain characteristics, variations, or combinations of these. The following are images and definitions of the 10 principal cloud types and their commonly used symbols.

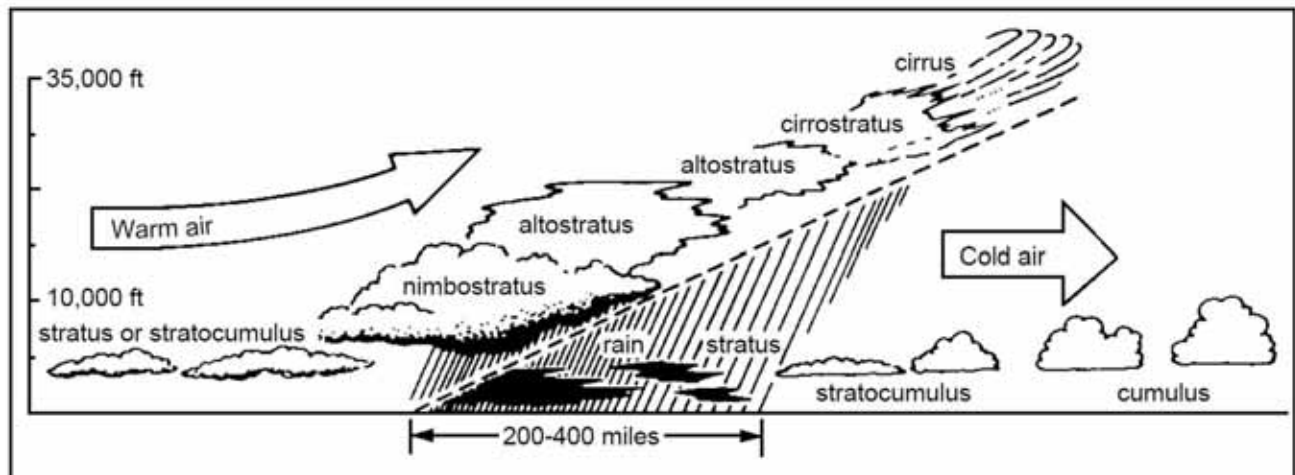

Figure 4013b. Vertical section of clouds ahead of a low. If a warm front is present, it will lie along the dashed lines.

4014. High Clouds

Cirrus (Ci) (Figure 4014a through Figure 4014f) are detached high clouds of delicate and fibrous appearance, without shading, generally white in color, often of a silky appearance. Their fibrous and feathery appearance is caused by their composition of ice crystals. Cirrus appear in varied forms, such as isolated tufts; long, thin lines across the sky; branching, feather-like plumes; curved wisps which may end in tufts, and

other shapes. These clouds may be arranged in parallel bands which cross the sky in great circles, and appear to converge toward a point on the horizon. This may indicate the general direction of a low pressure area. Cirrus may be brilliantly colored at sunrise and sunset. Because of their height, they become illuminated before other clouds in the morning, and remain lighted after others at sunset. Cirrus are generally associated with fair weather, but if they are followed by lower and thicker clouds, they are often the forerunner of rain or snow.



Figure 4014a. Dense Cirrus in patches or sheaves, not increasing, or Cirrus like cumuliform tufts.



Figure 4014c. Cirrus filaments, strands, hooks, not expanding.

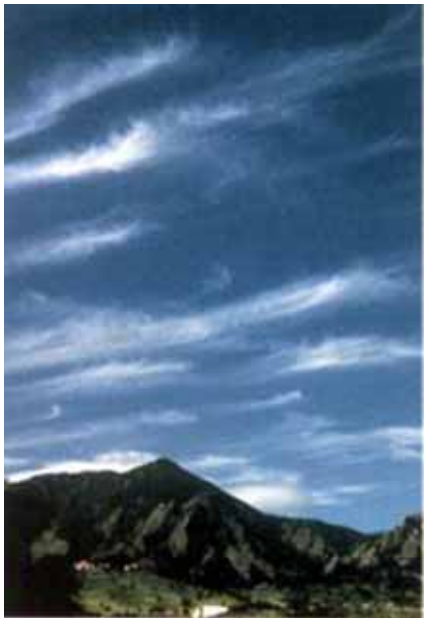

Figure 4014b. Cirrus filaments, strands, hooks, not expanding.



Figure 4014d. Dense Cirrus in patches or sheaves, not increasing, or Cirrus like cumuliform tufts.

Cirrostratus (Cs) (Figure 4014g through Figure 4014p) are thin, whitish, high clouds sometimes covering the sky completely and giving it a milky appearance and at other times presenting, more or less distinctly, a formation like a tangled web. The thin veil is not sufficiently dense to blur the outline of the Sun or Moon. However, the ice crystals of which the cloud is composed refract the light passing through to form halos with the Sun or Moon at the center. As cirrus begins to thicken, it will change into cirrostratus. In this form it is popularly known as “mares’ tails.” If it continues to thicken and lower, with the ice crystals melting to form water droplets, the cloud formation is known as altostratus. When this occurs, rain may normally be expected within 24 hours. The more brush-like the cirrus when the sky appears, the stronger the wind at the level of the cloud.



Figure 4014e. Dense Cirrus, often the anvil remaining from Cumulonimbus.

Cirrocumulus (Cc) (Figure 4014q and Figure 4014r) are high clouds composed of small white flakes or scales, or



Figure 4014f. Dense Cirrus, often the anvil remaining from Cumulonimbus.



Figure 4014i. Cirrus bands and/or Cirrostratus, increasing, growing denser, veil below 45.



Figure 4014g. Cirrus hooks or filaments, increasing and becoming denser.



Figure 4014j. Cirrus bands and/or Cirrostratus, increasing, growing denser, veil below 45.



Figure 4014h. Cirrus hooks or filaments, increasing and becoming denser.



Figure 4014k. Cirrus bands and/or Cirrostratus, increasing, growing denser, veil below 45.

of very small globular masses, usually without shadows and arranged in groups of lines, or more often in ripples resembling sand on the seashore. One form of cirrocumulus is popularly known as “mackerel sky” because the pattern resembles the scales on the back of a mackerel. Like cirrus, cirrocumulus are composed of ice crystals and are generally

associated with fair weather, but may precede a storm if they thicken and lower. They may turn gray and appear hard before thickening.



Figure 4014l. Cirrus bands and/or Cirrostratus, increasing, growing denser, veil below 45.



Figure 4014n. Cirrostratus covering the whole sky.



Figure 4014m. Cirrostratus covering the whole sky.



Figure 4014o. Cirrostratus, not increasing, not covering the whole sky.

4015. Middle Level Clouds

Altostratus (As) (Figure 4015a through Figure 4015d) are middle level clouds having the appearance of a grayish or bluish, fibrous veil or sheet. The Sun or Moon, when seen through these clouds, appears as if it were shining through ground glass with a corona around it. Halos are not formed. If these clouds thicken and lower, or if low, ragged “scud” or rain clouds (nimbostratus) form below them, continuous rain or snow may be expected within a few hours.

Alto cumulus (Ac) (Figure 4015e through Figure 4015r) are middle level clouds consisting of a layer of large, ball-like masses that tend to merge together. The balls or patches may vary in thickness and color from dazzling white to dark gray, but they are more or less



Figure 4014p. Cirrostratus, not increasing, not covering the whole sky.

regularly arranged. They may appear as distinct patches similar to cirrocumulus, but can be distinguished by hav-



Figure 4014q. Cirrocumulus alone, and/or Cirrus and Cirrostratus.



Figure 4014r. Cirrocumulus alone, and/or Cirrus and Cirrostratus.

ing individual patches which are generally larger, showing distinct shadows in some places. They are often mistaken for stratocumulus. If altocumulus thickens and lowers it may produce thundery weather and showers, but it does not bring prolonged bad weather. Sometimes the patches merge to form a series of big rolls resembling ocean waves, with streaks of blue sky between. Because of perspective, the rolls appear to run together near the



Figure 4015a. Altostratus, semitransparent, Sun or Moon dimly visible.



Figure 4015b. Altostratus, semitransparent, Sun or Moon dimly visible.



Figure 4015c. Altostratus, dense enough to hide Sun or Moon, or nimbostratus.

horizon. These regular parallel bands differ from cirrocumulus because they occur in larger masses with shadows. Altocumulus move in the direction of the short dimension of the rolls, like ocean waves. Sometimes altocumulus appear briefly in the form shown in Figure 4015o and Figure 4015p, sometimes before a thunderstorm. They are generally arranged in a line with a flat horizontal base, giving the impression of turrets on a cas-



Figure 4015d. Altostratus, dense enough to hide Sun or Moon, or nimbostratus

tle. The turreted tops may look like miniature cumulus and possess considerable depth and great length. These clouds usually indicate a change to chaotic, thundery skies.



Figure 4015e. Altocumulus, semitransparent, cloud elements change slowly, one level.



Figure 4015f. Altocumulus, semitransparent, cloud elements change slowly, one level.

4016. Low Clouds

Cumulus (Cu) (Figure 4016a through Figure



Figure 4015g. Altocumulus patches, semitransparent, multilevel, cloud elements changing, also Altocumulus Lenticular



Figure 4015h. Altocumulus patches, semitransparent, multilevel, cloud elements changing, also Altocumulus Lenticular

4016d) are dense clouds with vertical development formed by rising air which is cooled as it reaches greater heights. They have a horizontal base and dome-shaped upper surfaces, with protuberances extending above the dome. Cumulus appear in patches, never covering the entire sky. When vertical development is not great, the clouds resemble tufts of cotton or wool, being popularly



Figure 4015i. Altocumulus, one or more bands or layers, expanding, thickening.



Figure 4015j. Altocumulus, one or more bands or layers, expanding, thickening.

called “woolpack” clouds. The horizontal bases of such clouds may not be noticeable. These are called “fair weather” cumulus because they commonly accompany stable air and good weather. However, they may merge with altocumulus, or may grow to cumulonimbus before a thunderstorm. Since cumulus are formed by updrafts, they are accompanied by turbulence, causing “bumpiness” in the air. The extent of turbulence is proportional to the vertical extent of the clouds. Cumulus



Figure 4015k. Altocumulus from the spreading of Cumulus or Cumulonimbus.



Figure 4015l. Altocumulus from the spreading of Cumulus or Cumulonimbus.



Figure 4015m. Altocumulus, one or more layers, mainly opaque, not expanding, or Altocumulus with Altostratus or Nimbostratus.

are marked by strong contrasts of light and dark.

Stratocumulus (Sc) (Figure 4016e through Figure 4016h) are low level clouds appearing as soft, gray, roll-shaped masses. They may be shaped in long, parallel rolls similar to altocumulus moving forward with the wind. The



Figure 4015n. Altocumulus, one or more layers, mainly opaque, not expanding, or Altocumulus with Altostratus or Nimbostratus.



Figure 4015o. Altocumulus with tower or turret like sproutings.



Figure 4015p. Altocumulus with tower or turret-like sproutings.

motion is in the direction of their short dimension, like ocean waves. These clouds, which vary greatly in altitude, are the final product of the characteristic daily change taking place in cumulus clouds. They are usually followed by clear skies during the night.

Stratus (St) (Figure 4016i through Figure 4016l) is a low



Figure 4015q. Altocumulus of a chaotic sky, usually with heavy broken cloud sheets at different levels.



Figure 4015r. Altocumulus of a chaotic sky, usually with heavy broken cloud sheets at different levels.



Figure 4016a. Cumulus with very little vertical extent.

cloud in a uniform layer resembling fog. Often the base is not more than 1,000 feet high. A veil of thin stratus gives the sky a hazy appearance. Stratus is often quite thick, permitting so little sunlight to penetrate that it appears dark to an observer below. From above it is white. Light mist may descend from stratus. Strong wind sometimes breaks stratus into shreds called “fractostratus.”

Nimbostratus (Ns) (Figure 4016m and Figure 4016n) is a low, dark, shapeless cloud layer, usually nearly uniform, but sometimes with ragged, wet-looking bases.



Figure 4016b. Cumulus with very little vertical extent.



Figure 4016e. Stratocumulus from the spreading out of Cumulus.



Figure 4016c. Cumulus with moderate or greater vertical extent.



Figure 4016f. Stratocumulus from the spreading out of Cumulus.



Figure 4016d. Cumulus with moderate or greater vertical extent.



Figure 4016g. Stratocumulus not formed from the spreading out of Cumulus.

Nimbostratus is the typical rain cloud. The precipitation which falls from this cloud is steady or intermittent, but not showery.

Cumulonimbus (Cb) (Figure 4016o through Figure 4016r) is a massive cloud with great vertical development, rising in mountainous towers to great

heights. The upper part consists of ice crystals, and often spreads out in the shape of an anvil which may be seen at such distances that the base may be below the horizon. Cumulonimbus often produces showers of rain, snow, or hail, frequently accompanied by lightning and thunder. Because of this, the cloud is often popularly called a “thundercloud” or “thunderhead.” The base is horizontal, but as showers occur it lowers and becomes ragged.



Figure 4016h. Stratocumulus not formed from the spreading out of Cumulus.



Figure 4016k. Stratus fractus and/or Cumulus fractus of bad weather.



Figure 4016i. Stratus in a sheet or layer.



Figure 4016l. Stratus fractus and/or Cumulus fractus of bad weather.



Figure 4016j. Stratus in a sheet or layer.



Figure 4016m. Nimbostratus formed from lowering Altostratus.

4017. Cloud Height Measurement

At sea, cloud heights are often determined by estimation. This is a difficult task, particularly at night.

The height of the base of clouds formed by vertical development (any form of cumulus), if formed in air that has risen from the surface of the Earth, can be determined by psychrometer. This is because the height to which the air must rise before condensation takes place is proportional to

the difference between surface air temperature and the dew point. At sea, this difference multiplied by 126.3 gives the height in meters. That is, for every degree difference between surface air temperature and the dew point, the air must rise 126.3 meters before condensation will take place. Thus, if the dry-bulb temperature is 26.8°C, and the wet-bulb temperature is 25.0°C, the dew point is 24°C, or 2.8°C



Figure 4016n. Nimbostratus formed from lowering Altostratus.



Figure 4016p. Cumulonimbus, tops not fibrous, outline not completely sharp, no anvil.



Figure 4016o. Cumulonimbus, tops not fibrous, outline not completely sharp, no anvil.

lower than the surface air temperature. The height of the cloud base is $2.8 \times 126.3 = 354$ meters.



Figure 4016q. Cumulonimbus with fibrous top, often with an anvil.



Figure 4016r. Cumulonimbus with fibrous top, often with an anvil.

OTHER OBSERVATIONS

4018. Visibility Measurement

Visibility is the horizontal distance at which prominent objects can be seen and identified by the unaided eye. It is usually measured directly by the human eye. Ashore the distances of various buildings, trees, lights, and other objects can be used as a guide in estimating the visibility. At sea, however, such an estimate is difficult to make with accuracy. Other ships and the horizon may be of some assistance. See the Distance of the Horizon (Table 12).

Ashore, visibility is sometimes measured by a **transmissometer**, a device which measures the transparency of the atmosphere by passing a beam of light over a known short distance, and comparing it with a reference light.

4019. Upper Air Observations

Upper air information provides the third dimension to the weather map. Unfortunately, the equipment necessary to obtain such information is quite expensive, and the observations are time consuming. Consequently, the network of observing stations is quite sparse compared to that for surface observations, particularly over the oceans and in isolated land areas. Where facilities exist, upper air observations are made by means of unmanned balloons, in conjunction with theodolites, radiosondes, and radar.

4020. New Technologies in Weather Observing

Shipboard, upper air, buoy, radar, and satellite observations are the foundation for the development of accurate forecast computer models, both in the short and long term. New techniques such as Doppler radar, satellite analysis, and the integration of data from many different sites into complex computer algorithms provide a method of predicting storm tracks with a high degree of accuracy. Tornadoes, line squalls, individual thunderstorms, and entire storm systems can be continuously tracked and their paths predicted with unprecedented accuracy. At sea, the mariner has immediate access to this data through facsimile transmission of synoptic charts, satellite photographs, communications

satellite contact with weather routing services, or through internet providers.

Automated weather stations and buoy systems provide regular transmissions of meteorological and oceanographic information by radio. Some of these buoys or stations can be accessed via the telephone. For further information, visit the National Data Buoy Center's web site at [https:// www.ndbc.noaa.gov](https://www.ndbc.noaa.gov). These buoys and stations are generally located at isolated and relatively inaccessible locations from which weather and ocean data are of great importance. Depending on the type of system used, the elements usually measured include wind direction and speed, atmospheric pressure, air and sea surface temperature, spectral wave data, and a temperature profile from the sea surface to a predetermined depth.

Regardless of advances in the technology of observing and forecasting, the shipboard weather report remains the cornerstone upon which the accuracy of many forecasts are based.

4021. Recording Observations

Instructions for recording weather observations aboard U.S. Navy vessels are given in NAVMETOC-COMINST 3144.1 (series).

Instructions for recording observations aboard merchant vessels are given in the National Weather Service *Observing Handbook No. 1, Marine Surface Observations*. The handbook is available online via the link provided in Figure 4021.



Figure 4021. Link to Weather Observing Handbook No. 1, Marine Surface Observations.

https://www.vos.noaa.gov/ObsHB-508/ObservingHandbook1_2010_508_compliant.pdf



Force 0: Wind Speed less than 1 knot.
Sea: Sea like a mirror.



Force 1: Wind Speed 1-3 knots.
Sea: Wave height 0.1m (.25ft); Ripples with appearance of scales, no foam crests.



Force 2: Wind Speed 4-6 knots.

Sea: Wave height 0.2-0.3 m (0.5-1 ft); Small wavelets, crests of glassy appearance, not breaking.



Force 3: Wind Speed 7-10 knots.

Sea: Wave height 0.6-1m (2-3 ft); Large wavelets, crests begin to break, scattered whitecaps.



Force 4: Wind Speed 11-16 knots.

Sea: Wave height 1-1.5 m (3.5-5 ft); Small waves becoming longer, numerous whitecaps.



Force 5: Wind Speed 17-21 knots.

Sea: Wave height 2-2.5 m (6-8 ft); Moderate waves, taking longer form, many whitecaps, some spray.



Force 6: Wind Speed 22-27 knots.

Sea: Wave height 3-4 m (9.5-13 ft); Larger waves forming, whitecaps everywhere, more spray.



Force 7: Wind Speed 28-33 knots.

Sea: Wave height 4-5.5 m (13.5-19 ft); Sea heaps up, white foam from breaking waves begins to be blown in streaks along direction of wind.



Force 8: Wind Speed 34-40 knots.

Sea: Wave height 5.5-7.5 m (18-25 ft); Moderately high waves of greater length, edges of crests begin to break into spindrift, foam is blown in well marked streaks.



Force 9: Wind Speed 41-47 knots.

Sea: Wave height 7-10 m (23-32 ft); High waves, sea begins to roll, dense streaks of foam along wind direction, spray may reduce visibility.



Force 10: Wind Speed 48-55 knots (storm).

Sea: Wave height 9-12.5 m (29-41 ft); Very high waves with overhanging crests, sea takes white appearance as foam is blown in very dense streaks, rolling is heavy and shocklike, visibility is reduced.



Force 11: Wind Speed 56-63 knots.

Sea: Wave height 11.5-16 m (37-52 ft); Exceptionally high waves, sea covered with white foam patches, visibility still more reduced.



Force 12: Wind Speed 64-71 knots.

Sea: Wave height more than 16 m (52 ft); Air filled with foam, sea completely white with driving spray, visibility greatly reduced.

CHAPTER 41

WEATHER ROUTING

PRINCIPLES OF WEATHER ROUTING

4100. Introduction

Ship weather routing develops an optimum track for ocean voyages based on forecasts of weather, sea conditions, and a ship's individual characteristics for a particular transit. Within specified limits of weather and sea conditions, the term optimum is used to mean maximum safety and crew comfort, minimum fuel consumption, minimum time underway, or any desired combination of these factors. The purpose of this chapter is to acquaint the mariner with the basic philosophy and procedures of ship weather routing as an aid to understanding the routing agency's recommendations.

The mariner's first resources for route planning in relation to weather are the *Pilot Chart Atlases* (Figure 4100a), the *Sailing Directions (Planning Guides)* (Figure 4100b), and other climatological sources such as historical weather data tables. These publications give climatic data, such as wind speed and direction, wave height frequencies and ice limits, for the major ocean basins of the world. They may recommend specific routes based on probabilities, but not on specific conditions.



Figure 4100a. *Pilot Chart Atlases*
https://msi.nga.mil/NGAPortal/MSI.portal?_nfpb=true&_pageLabel=msi_portal_page_62&pubCode=0003.

The ship routing agency, acting as an advisory service, attempts to avoid or reduce the effects of specific adverse weather and sea conditions by issuing initial route recommendations prior to sailing. It recommends track changes while underway (diversions), and weather advisories to alert the commanding officer or master about approaching unfavorable weather and sea conditions which cannot be effectively avoided by a diversion. Adverse weather and sea conditions are defined as those conditions which will cause damage, significant speed reduction, or time loss.



Figure 4100b. *Sailing Directions (Planning Guides)*
https://msi.nga.mil/NGAPortal/MSI.portal?_nfpb=true&_pageLabel=msi_portal_page_62&pubCode=0011.

The initial route recommendation is based on a survey of weather and sea forecasts between the point of departure and the destination. It takes into account the type of vessel, hull type, speed capability, safety considerations, cargo, and loading conditions. The vessel's progress is continually monitored, and if adverse weather and sea conditions are forecast along the vessel's current track, a recommendation for a diversion or a weather advisory is transmitted. By this process of initial route selection and continued monitoring of progress for possible changes in the forecast weather and sea conditions along a route, it is possible to maximize both speed and safety.

In providing for optimum sailing conditions, the advisory service also attempts to reduce transit time by avoiding the adverse conditions which may be encountered on a shorter route, or if the forecasts permit, diverting to a shorter track to take advantage of favorable weather and sea conditions. A significant advantage of weather routing accrues when: (1) the passage is relatively long, about 1,500 miles or more; (2) the waters are navigationally unrestricted, so that there is a choice of routes; and (3) weather is a factor in determining the route to be followed.

Use of this advisory service in no way relieves the commanding officer or master of responsibility for prudent seamanship and safe navigation. There is no intent by the routing agency to inhibit the exercise of professional judgment and prerogatives of commanding officers and masters.

The techniques of ship routing and access to the advice are increasingly less expensive, and are thus being made available to coastal vessels, smaller commercial craft, and even yachts.

4101. Historical Perspective

The advent of extended range forecasting and the development of selective climatology, along with powerful computer modeling techniques, have made ship routing systems possible. The ability to effectively advise ships to take advantage of favorable weather was hampered previously by forecast limitations and the lack of an effective communications system.

Development work in the area of data accumulation and climatology has a long history. Benjamin Franklin, as deputy postmaster general of the British Colonies in North America, produced a chart of the Gulf Stream from information supplied by masters of New England whaling ships. This first mapping of the Gulf Stream helped improve the mail packet service between the British Colonies and England. In some passages the sailing time was reduced by as much as 14 days over routes previously sailed.

In the mid-19th century, Matthew Fontaine Maury compiled large amounts of atmospheric and oceanographic data from ships' log books. For the first time, a climatology of ocean weather and currents of the world was available to the mariner. This information was used by Maury to develop seasonally recommended routes for sailing ships and early steam powered vessels in the latter half of the 19th century. In many cases, Maury's charts were proved correct by the savings in transit time. Average transit time on the New York to California via Cape Horn route was reduced from 183 days to 139 days with the use of his recommended seasonal routes.

In the 1950's the concept of ship weather routing was put into operation by several private meteorological groups and by the U.S. Navy. By applying the available surface and upper air forecasts to transoceanic shipping, it was possible to effectively avoid much heavy weather while generally sailing shorter routes than previously. The development of computers, the Internet and communications technology has made weather routing available to nearly everyone afloat.

4102. System Types

Optimum Track Ship Routing (OTSR), the ship routing service of the U.S. Navy, utilizes short to medium range forecasting techniques in route selection and surveillance procedures. The short to medium range dynamic forecasts of 3 to 10 days are derived from meteorological equations processed by high-speed super computers. These forecasts are computed at least twice daily from a data base of global surface and upper air observations, and include surface pressure, upper air constant pressure heights and spectral wave values. A significant increase in data acquisition, particularly from satellite imagery over oceans and data sparse areas have extended the time period for which these forecasts are useful.

Selective climatology has been effective in predicting average conditions months in advance during such events as the El Nino Southern Oscillation (ENSO) which encompasses both the El Nino and La Nina. Such predictions do

not represent forecasting, but can indicate the likelihood of certain atmospheric weather patterns appearing or prevailing.

For extended range forecasting, generally beyond ten days, computer models use a combination of analogs, climatology and ensemble techniques to find the logical sequence of events following the dynamic forecasts of 3 to 10 days. Beyond ten days, climatology is used to determine the optimum track.

Aviation was first in applying the principle of minimum time tracks (MTT) to a changing wind field. But the problem of finding an MTT for a specific flight is much simpler than for a transoceanic ship passage because an aircraft's transit time is much shorter than a ship's. Thus, marine minimum time tracks require significantly longer range forecasts to develop an optimum route.

Automation has enabled ship routing agencies to develop realistic minimum time tracks. Computation of minimum time tracks makes use of:

1. A navigation system to compute route distance, time enroute, estimated times of arrival (ETA's), and to provide 6 hourly DR synoptic positions for the range of the dynamic forecasts for the ship's current track.
2. A surveillance system to survey wind, seas, fog, and ocean currents obtained from the dynamic and climatological fields.
3. An environmental constraint system imposed as part of the route selection and surveillance process. Constraints are the upper limits of wind and seas desired for the transit. They are determined by the ship's loading, speed capability, and vulnerability. The constraint system is an important part of the route selection process and acts as a warning system when the weather and sea forecast along the present track exceeds predetermined limits.
4. Ship speed characteristics used to approximate ship's speed of advance (SOA) while transiting the forecast sea states.

Criteria for route selection reflect a balance between the captain's desired levels of speed, safety, comfort, and consideration of operations such as fleet maneuvers, fishing, towing, etc.

Ship weather routing services are being offered by many nations. These include Japan, United Kingdom, Russia, Netherlands, Germany, and the United States. Also, several private firms provide routing services to shipping industry clients. Several personal computer-based software applications have become available, making weather routing available to virtually everyone at sea.

There are two general types of routing services available. The first uses techniques similar to the Navy's Optimum Track Ship Routing (OTSR) system to forecast conditions and compute routing recommendations, which are then broadcast to the vessel. Because this service is per-

formed ashore, it allows for greater computer power to be applied to the routing task. The second assembles and processes weather and sea condition data and transmits this to ships at sea for on-board processing and generation of route recommendations. This system allows the ship's master to have greater flexibility in changing parameters, evaluating various scenarios, selecting routes, and displaying data.

4103. Ship and Cargo Considerations

Ship and cargo characteristics have a significant influence on the application of ship weather routing. Ship size, speed capability, and type of cargo are important considerations in the route selection process prior to sailing and the surveillance procedure while underway. A ship's characteristics identify its vulnerability to adverse conditions and its ability to avoid them.

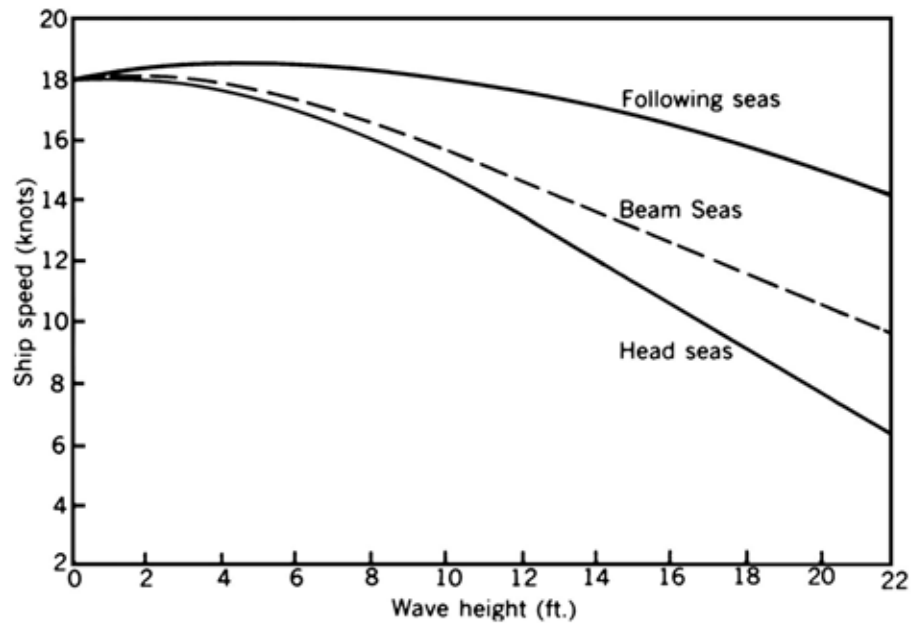

Figure 4103. Performance curves for head, beam, and following seas.

Generally, ships with higher speed capability and lighter loads will have shorter optimum routes and be better able to maintain near normal SOA's than ships with lower speed capability or heavy cargoes. Some routes are unique because of the type of ship or cargo. Avoiding one element of weather to reduce pounding or rolling may be of prime importance. For example, a 20 knot ship with a heavy deck cargo may be severely hampered in its ability to maintain a 20 knot SOA in any seas exceeding moderate head or beam seas because of the possibility of damage resulting from the deck load's characteristics. A similar ship with a stable cargo under the deck is not as vulnerable and may be able to maintain the 20 knot SOA in conditions which would drastically slow the deck-loaded vessel. In towing operations, a tug is more vulnerable to adverse weather and sea conditions, not only in consideration of the tow, but also because of its already limited speed capability. Its slow speed adds to the difficulty of avoiding adverse weather and sea conditions.

Ship performance curves (speed curves) are used to estimate the ship's SOA while transiting the forecast sea states. The curves indicate the effect of head, beam, and following seas of various significant wave heights on the ship's speed. Figure 4103 is a performance curve prepared

for a commercial 18-knot vessel. Each vessel will have its own performance curves, which vary widely according to hull type, length, beam, shape, power, and tonnage. Recommendations for sailing vessels must account for wind speed, wind angle, and vessel speed.

With the speed curves it is possible to determine just how costly a diversion will be in terms of the required distance and time. A diversion may not be necessary where the duration of the adverse conditions is limited. In this case, it may be better to ride out the weather and seas knowing that a diversion, even if able to maintain the normal SOA, will not overcome the increased distance and time required.

At other times, the diversion track is less costly because it avoids an area of adverse weather and sea conditions, while being able to maintain normal SOA even though the distance to destination is increased. Based on input data for environmental conditions and ship's behavior, route selection and surveillance techniques seek to achieve the optimum balance between time, distance, and acceptable environmental and seakeeping conditions. Although speed performance curves are an aid to the ship routing agency, the response by mariners to deteriorating weather and sea conditions is not uniform. Some reduce

speed voluntarily or change heading sooner than others when unfavorable conditions are encountered. Certain waves with characteristics such as the ship's bow and stern are in successive crests and troughs present special problems for the mariner. Being nearly equal to the ship's length, such wavelengths may induce very dangerous stresses. The degree of hogging and sagging and the associated danger may be more apparent to the mariner than to the ship routing agency. Therefore, adjustment in course and speed for a more favorable ride must be initiated by the commanding officer or master when this situation is encountered.

4104. Environmental Factors

Environmental factors of importance to ship weather routing are those elements of the atmosphere and ocean that may produce a change in the status of a ship transit. In ship routing, consideration is given to wind, seas, fog, ice, and ocean currents. While all of the environmental factors are important for route selection and surveillance, optimum routing is normally considered attained if the effects of wind and seas can be optimized.

Wind: The effect of wind speed on ship performance is difficult to determine. In light winds (less than 20-knots), ships lose speed in headwinds and gain speed slightly in following winds. For higher wind speeds, ship speed is reduced in both head and following winds. This is due to the increased wave action, which even in following seas results in increased drag from steering corrections, and indicates the importance of sea conditions in determining ship performance. In dealing with wind, it is also necessary to know the ship's sail area. High winds will have a greater adverse effect on a large, fully loaded container ship or car carrier than a fully loaded tanker of similar length. This effect is most noticeable when docking or when navigating in restricted waters, but the effect of beam winds over several days at sea can also be considerable. For sailing vessels, the wind is critical and accurate forecasts are vital to a successful voyage.

Wave Height: Wave height is the major factor affecting ship performance. Wave action is responsible for ship motions which reduce propeller thrust and cause increased drag from steering corrections. The relationship of ship speed to wave direction and height is similar to that of wind. Head seas reduce ship speed, while following seas increase ship speed slightly to a certain point, beyond which they retard it. In heavy seas, exact performance may be difficult to predict because of the adjustments to course and speed for shiphandling and comfort. Although the effect of sea and swell is much greater for large commercial vessels than is wind speed and direction, it is difficult to separate the two in ship routing.

In an effort to provide a more detailed description of the actual and forecast sea state, several countries and private companies have developed global and regional wave

forecasting computer programs. These wave forecasts are based on the analyzed and forecast planetary boundary wind fields and are produced for both the Northern and Southern Hemispheres out to 144 hours or more. Most of these forecasts produce values for significant wave height, primary wave height and secondary wave height, as well as direction and period of these waves.

Fog: Fog, while not directly affecting ship performance, should be avoided as much as feasible, in order to maintain normal speed in safe conditions. Extensive areas of fog during summertime can be avoided by selecting a lower latitude route than one based solely upon wind and seas. Although the route may be longer, transit time may be less due to not having to reduce speed in reduced visibility. In addition, crew fatigue due to increased watchkeeping vigilance can be reduced.

North Wall Effect: During the Northern Hemisphere fall and winter, the waters to the north of the Gulf Stream in the North Atlantic are at their coldest, while the Gulf Stream itself remains at a constant relatively warm temperature. After passage of a strong cold front or behind a developing coastal low pressure system, Arctic air is sometimes drawn off the Mid-Atlantic coast of the United States and out over the warm waters of the Gulf Stream by northerly winds. This cold air is warmed as it passes over the Gulf Stream, resulting in rapid and intense deepening of the low pressure system and higher than normal surface winds. Higher waves and confused seas result from these winds. When these winds oppose the northeast set of the current, the result is increased wave heights and a shortening of the wave period. If the opposing current is sufficiently strong, the waves will break. These phenomena are collectively called the "North Wall Effect," referring to the region of most dramatic temperature change between the cold water to the north and the warm Gulf Stream water to the south. The most dangerous aspect of this phenomenon is that the strong winds and extremely high, steep waves occur in a limited area and may develop without warning. Thus, a ship that is laboring in near-gale force northerly winds and rough seas, proceeding on a northerly course, can suddenly encounter storm force winds and dangerously high breaking seas. Numerous ships have foundered off the North American coast in the approximate position of the Gulf Stream's North Wall. A similar phenomenon occurs in the North Pacific near the Kuroshio Current and off the Southeast African coast near the Agulhas Current.

Ocean Currents: Ocean currents do not present a significant routing problem, but they can be a determining factor in route selection and diversion. This is especially true when the points of departure and destination are at relatively low latitudes. The important considerations to be evaluated are the difference in distance between a great-circle route and a route selected for optimum current, with the expected increase in SOA from the following current, and the decreased probability of a di-

version for weather and seas at the lower latitude. For example, it has proven beneficial to remain equatorward of approximately 22°N for westbound passages between the Canal Zone and southwest Pacific ports. For eastbound passages, if the maximum latitude on a great-circle track from the southwest Pacific to the Canal Zone is below 24°N, a route passing near the axis of the Equatorial Countercurrent is practical because the increased distance is offset by favorable current. Direction and speed of ocean currents are more predictable than wind and seas, but some variability can be expected. Major ocean currents can be disrupted for several days by very intense weather systems such as hurricanes and by global phenomena such as El Niño.



Figure 4104a. Ice accumulation on deck can cause significant problems with stability of small ships. Freezing spray conditions should be avoided when possible. Image courtesy of Lars Anderson, SMHI.

Ice: The problem of ice includes pack ice, floating ice of land origin (icebergs) and deck ice. Areas of icebergs or pack ice should be avoided because of the difficulty of detection and the potential for collision. Icebergs are a hazard in the North Atlantic from late February through July, and occasionally later. The hazard of floating ice is frequently combined with restricted visibility in fog. International Ice Patrol warnings are incorporated into the planning of routes to safely avoid dangerous iceberg areas. The International Convention for the Safety of Life At Sea (SOLAS) Chapter V, Regulation 6 requires ships transiting the region of icebergs guarded by the Ice Patrol during the ice season to make use of the services provided by the Ice Patrol. The Ice Patrol sets an Iceberg Limit to delineate this region of icebergs. Vessels are recommended to transit to the east and south of this region at all times. The Ice Patrol's iceberg warning products are updated daily in textual, graphical, and electronic format and can be accessed through the USCG NAVCEN web portal (see Figure 4104b). The U.S. Navy ship routing office at Fleet Weather Center Norfolk main-

tains a safety margin of 100 nautical miles from icebergs reported by the Ice Patrol. In a severe winter, the Denmark Strait may be closed due to the presence of icebergs.



Figure 4104b. North American Ice Service Products <https://www.navcen.uscg.gov/?pageName=iipProducts>.

Deck ice may be more difficult to contend with from a ship routing point of view because it is caused by freezing weather associated with a large weather system. While mostly a nuisance factor on large ships, it causes significant problems with the stability of small ships (Figure 4104a).

Latitude: Generally, the higher the latitude of a route, even in the summer, the greater are the problems with the environment. Certain operations should benefit from seasonal planning as well as optimum routing. For example, towing operations north of about 40° latitude should be avoided in non-summer months if possible.

4105. Synoptic Weather Considerations

A ship routing agency should direct its forecasting skills to avoiding or limiting the effect of weather and seas associated with extratropical low pressure systems in the mid and higher latitudes and the tropical systems in low latitude. Seasonal or monsoon weather is also a factor in route selection and diversion in certain areas.

Despite the amount of attention and publicity given to tropical cyclones, mid-latitude low pressure systems generally present more difficult problems to a ship routing agency. This is primarily due to the fact that major ship traffic is sailing in the latitudes of the migrating low pressure systems, and the amount of potential exposure to intense weather systems, especially in winter, is much greater.

Low pressure systems weaker than gale intensity (winds less than 34 knots) are not a severe problem for most ships. However, a relatively weak system may generate prolonged periods of rough seas which may hamper normal work aboard ship. Ship weather routing can frequently limit rough conditions to short periods of time and provide more favorable conditions for most of the transit. Relatively small vessels, tugs with tows, low powered ships, yachts, and

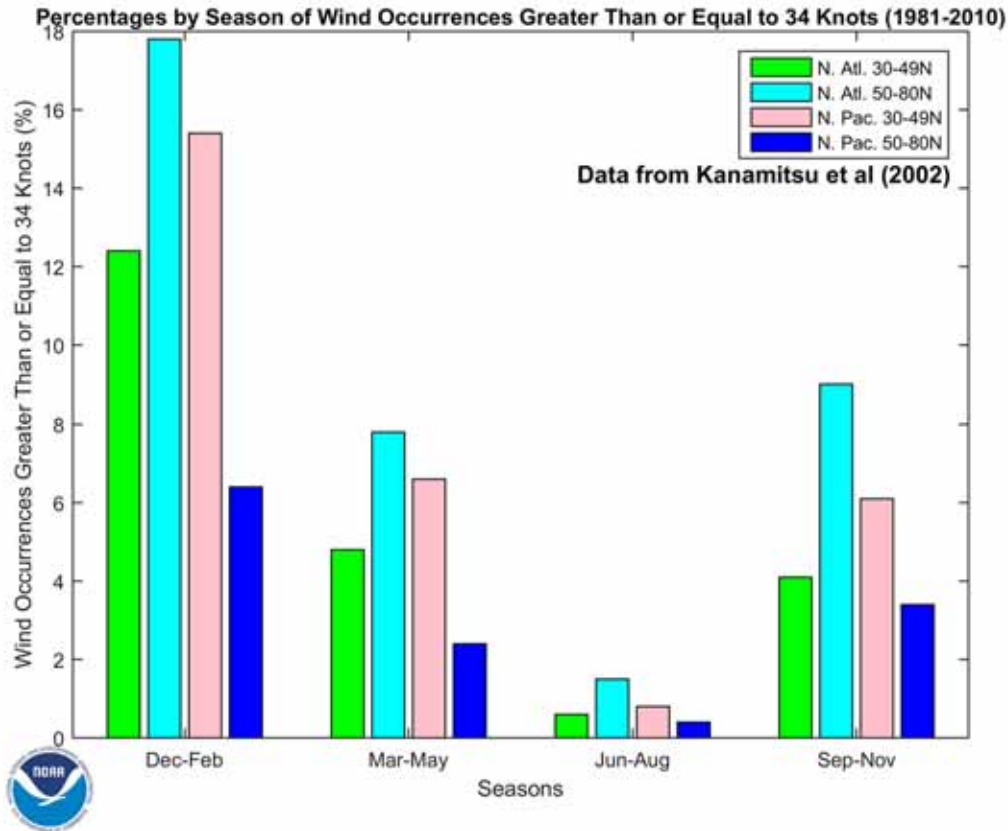

Figure 4105a. Percentages by season of wind occurrences greater than or equal to 34 knots, separated by geographic area. The percentages represent areas over the high seas only and do not include values over ice.

ships with sensitive cargoes can be significantly affected by weather systems weaker than gale intensity. Using a routing agency can enhance both safety and efficiency.

Gales (winds 34 to 47 knots) and storms (winds greater than 48 knots) in the open sea can generate very rough or high seas, particularly when an adverse current such as the Gulf Stream is involved. This can force a reduction in speed in order to gain a more comfortable and safe ride. Because of the extensive geographic area covered by a well developed low pressure system, once ship's speed is reduced the ability to improve the ship's situation is severely hampered. Thus, exposure to potential damage and danger is greatly increased. The vessel in such conditions may be forced to slow down just when it is necessary to speed up to avoid even worse conditions.

A recommendation for a diversion by a routing agency well in advance of the intense weather and associated seas will limit the duration of exposure of the vessel. If effective, ship speed will not be reduced and satisfactory progress will be maintained even though the remaining distance to destination is increased. Overall transit time is usually shorter than if no track change had been made and the ship had remained in heavy weather. In some cases diversions are

made to avoid adverse weather conditions and shorten the track at the same time. Significant savings in time and costs can result.

In very intense low pressure systems, with high winds and long duration over a long fetch, seas will be generated and propagated as swell over considerable distances. Even on a diversion, it is difficult to effectively avoid all unfavorable conditions. Generally, original routes for transoceanic passages, issued by the U.S. Navy's ship routing service, are within areas that experience gale force winds or higher often. Figure 4105a shows the frequency of gale force winds or higher by latitude in the North Atlantic and North Pacific. To avoid the area of significant gale activity in the Atlantic from October to April, the latitude of transit is generally in the lower thirties.

The areas, seasons, and the probability of development of tropical cyclones are fairly well defined in climatological publications. In long range planning, considerable benefit can be gained by limiting the exposure to the potential hazards of tropical systems.

It is advisable to avoid tropical cyclones. In the eastern North Pacific, the climatological distribution of tropical cyclones is relatively compact (See Figure 4105b). The

climatological distribution of tropical cyclones for the western North Pacific is shown in Figure 4105c. The

climatological distribution of tropical cyclones in the North Atlantic is shown in Figure 4105d.

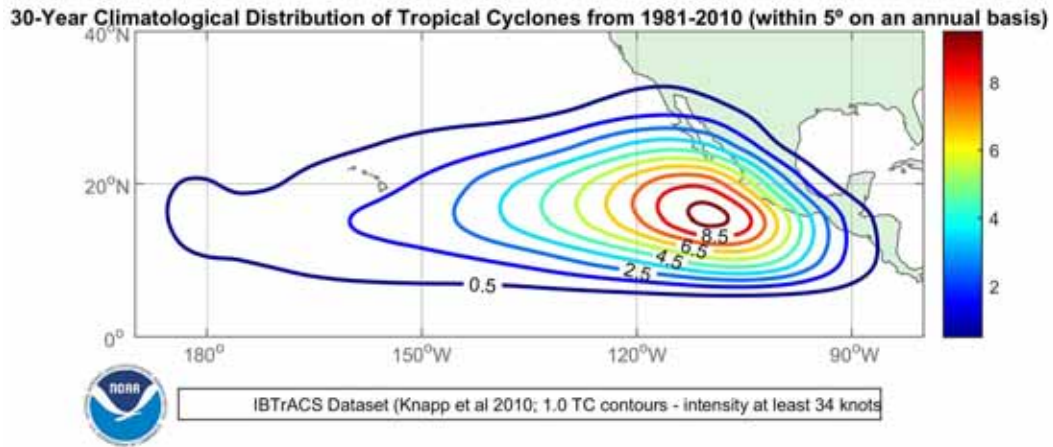

Figure 4105b. Average number of tropical cyclones that come within 5 degrees of a point in the Eastern Pacific Ocean.

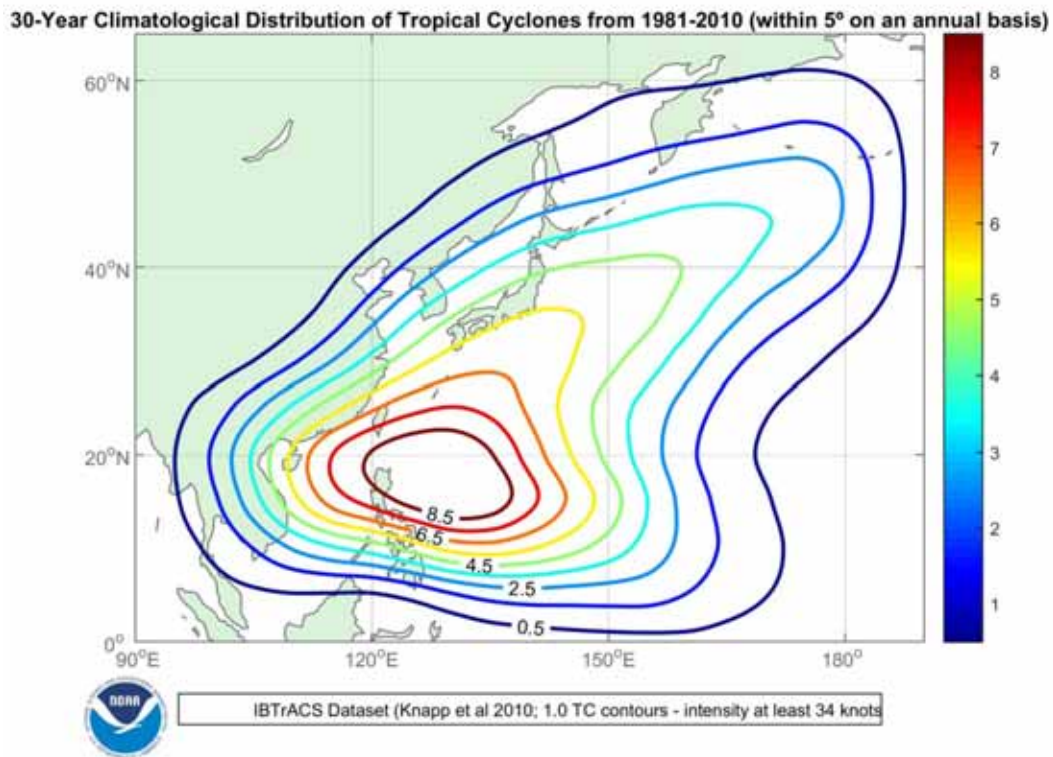

Figure 4105c. Average number of tropical cyclones that come within 5 degrees of a point in the Western Pacific Ocean.

It has proven equally beneficial to employ similar avoidance considerations for routing in the monsoon areas of the Indian Ocean and the South China Sea. This is accomplished by providing routes and diversions that generally avoid the areas of high frequency of tropical cyclones (Figure 4105e, Figure 4105f and Figure 4105g), gale force winds and asso-

ciated heavy seas, as much as feasible. Ships can then remain in satisfactory conditions with limited increases in route distance.

Depending upon the points of departure and destination, there are many combinations of routes that can be used when transiting the northern Indian Ocean (Arabian Sea, Bay of

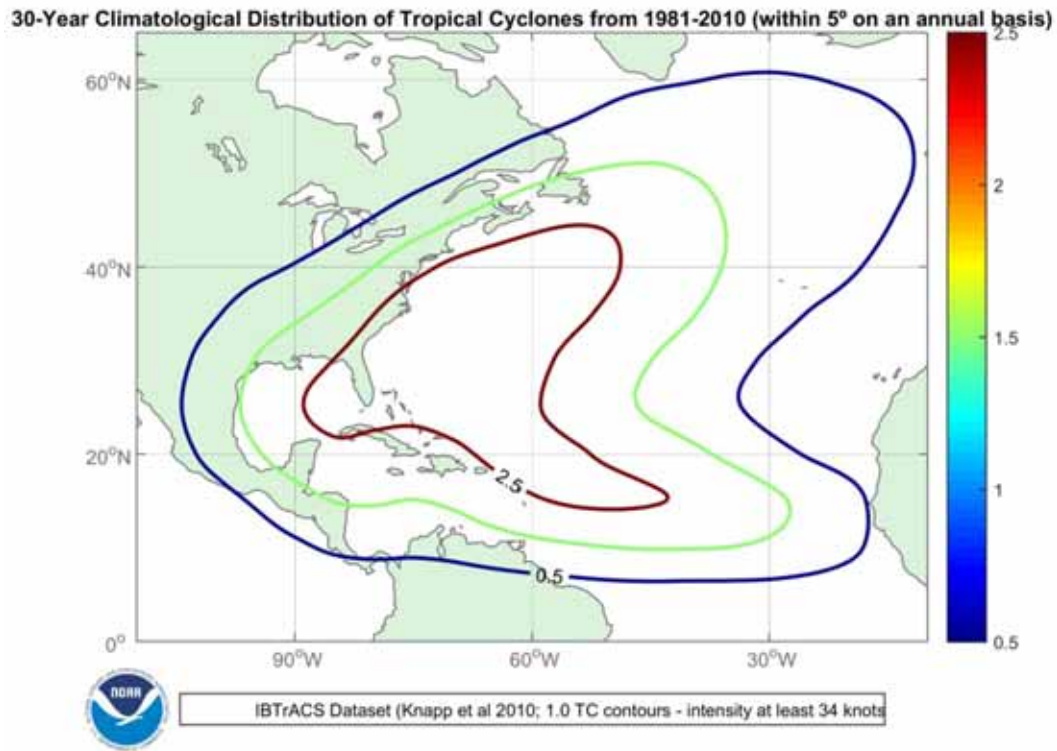

Figure 4105d. Average number of tropical cyclones that come within 5 degrees of a point in the North Atlantic Ocean.

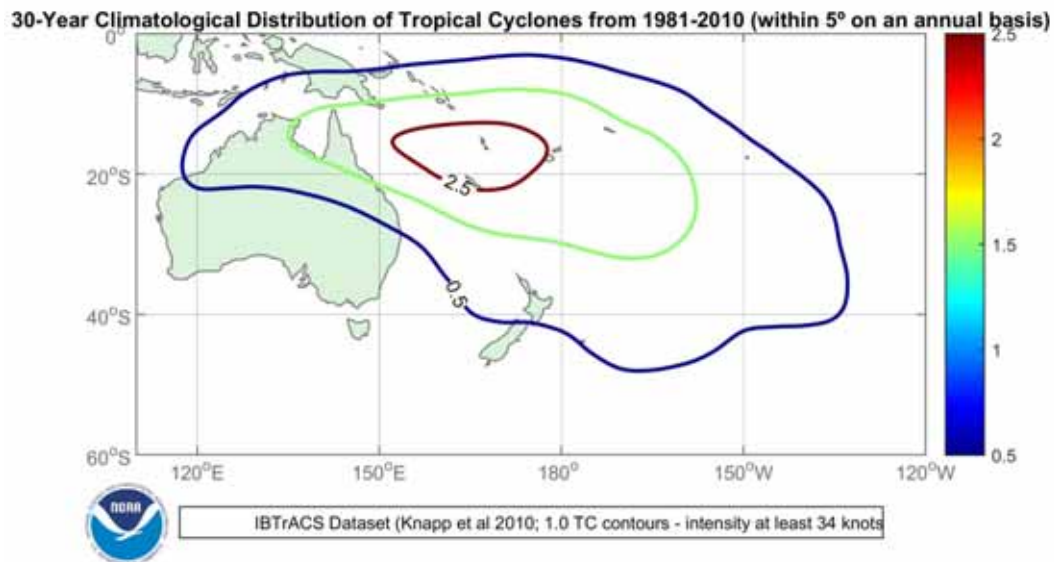

Figure 4105e. Average number of tropical cyclones that come within 5 degrees of a point in the South Pacific Ocean.

Bengal) and the South China Sea. For example, in the Arabian Sea during the summer monsoon, routes to and from the Red Sea, the western Pacific, and the eastern Indian Ocean should hold equatorward. Ships proceeding to the Persian Gulf during this period are held farther south and

west to put the heaviest seas on the quarter or stern when transiting the Arabian Sea. Eastbound ships departing the Persian Gulf may proceed generally east southeast toward the Indian sub-continent, then south, to pass north and east of the highest southwesterly seas in the Arabian Sea.

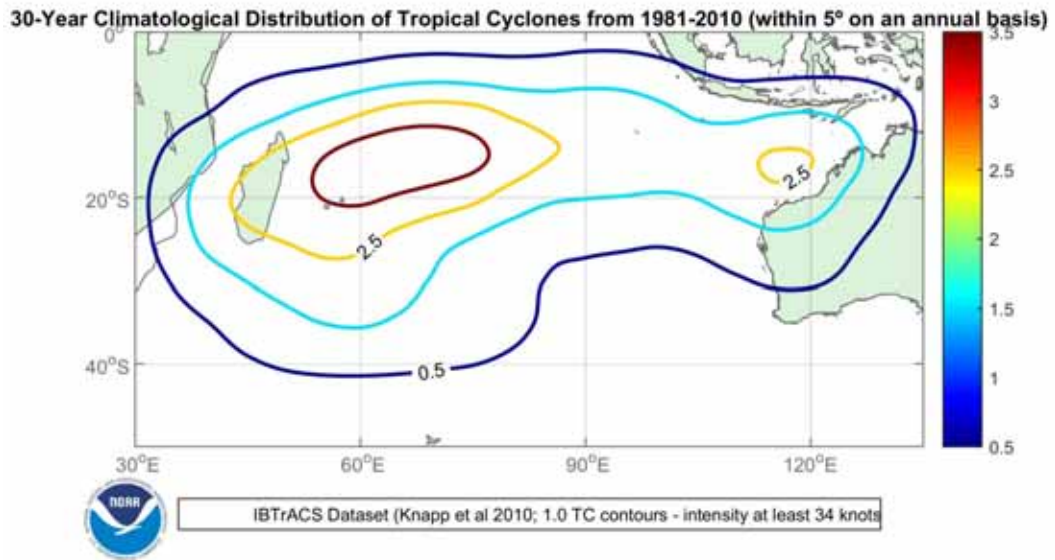

Figure 4105f. Average number of tropical cyclones that come within 5 degrees of a point in the South Indian Ocean.

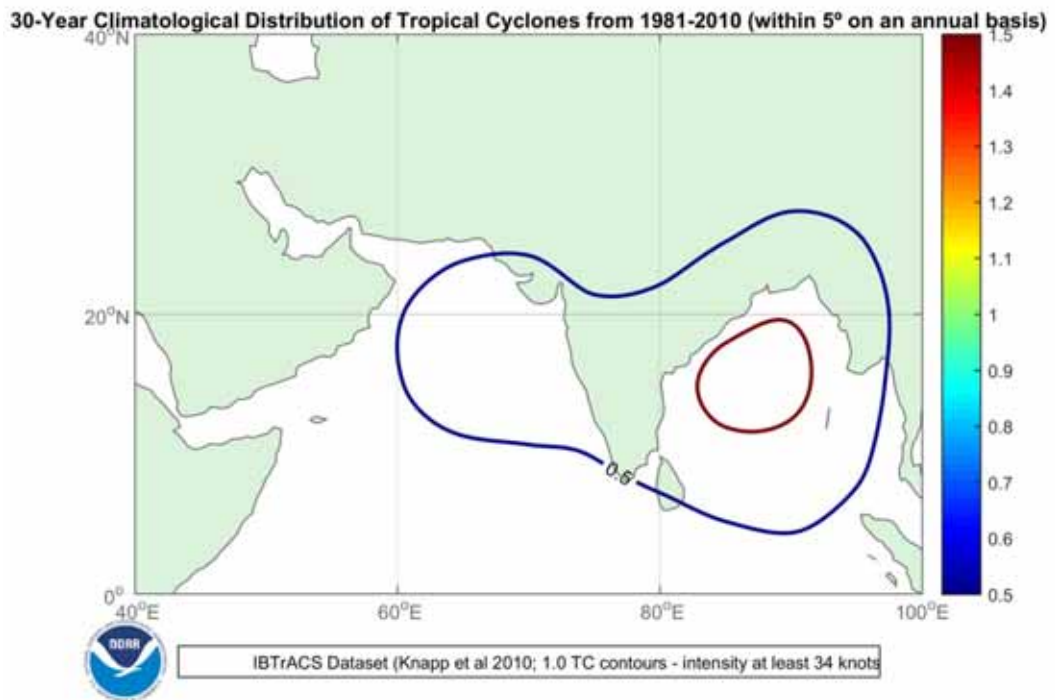

Figure 4105g. Average number of tropical cyclones (at least 34 knots) that come within 5 degrees of a point in the Bay of Bengal and Arabian Sea.

Westbound ships out of the Persian Gulf for the Cape of Good Hope appear to have little choice in routes unless considerable distance is added to the transit by passing east of the highest seas. In the winter monsoon, routes to or from the Red Sea for the western Pacific and the Indian Ocean are

held farther north in the Arabian Sea to avoid the highest seas. Ships proceeding to the Persian Gulf from the western Pacific and eastern Indian Ocean may hold more eastward when proceeding north in the Arabian Sea. Ships departing the Persian Gulf area will have considerably less difficulty

than during the summer monsoon. Similar considerations can be given when routing ships proceeding to and from the Bay of Bengal.

In the South China Sea, transits via the Palawan Passage are recommended when strong, opposing wind and seas are forecast. This is especially true during the winter monsoon. During periods when the major monsoon flow is slack, ships can use the shortest track as conditions permit.

4106. Special Weather and Environmental Considerations

In addition to the synoptic weather considerations in ship weather routing, there are special environmental problems that can be avoided by following recommendations and advisories of ship routing agencies. These problems generally cover a smaller geographic area and are seasonal in nature, but are still important to ship routing.

In the North Atlantic, because of heavy shipping traffic, frequent poor visibility in rain or fog, and restricted navigation, particularly east of Dover Strait, some mariners prefer to transit to or from the North Sea via Pentland Firth, passing north of the British Isles rather than via the English Channel.

Weather routed ships generally avoid the area of dense fog with low visibility in the vicinity of the Grand Banks off Newfoundland and the area east of Japan north of 35°N. Fishing vessels in these two areas provide an added hazard to safe navigation. This condition exists primarily from May through September. During summer, Arctic-bound shipping, transiting between the U.S. East Coast and the Davis Strait-Baffin Bay area, frequently use the Cabot Strait and the Strait of Belle Isle, where navigation aids are available and icebergs are typically present in large numbers following the melt of pack ice along the Labrador Coast in the spring.

In the northern hemisphere winter, a strong high pressure system moving southeast out of the Rocky Mountains brings cold air down across Central America and the western Gulf of Mexico producing gale force winds in the Gulf of Tehuantepec. This fall wind is similar to the pampero, mistral, and bora of other areas of the world. An adjustment to ship's track can successfully avoid the highest seas associated with the "Tehuantepecer." For transits between the Canal Zone and northwest Pacific ports, little additional distance is required to avoid this area (in winter) by remaining south of at least 12°N when crossing 97°W. While avoiding the highest seas, some unfavorable swell conditions may be encountered south of this line. Ships transiting between the Panama Canal and North American west coast ports can stay close along the coast of the Gulf of Tehuantepec to avoid heavy seas during gale conditions, but may still encounter high offshore winds.

In the summer, the semi-permanent high pressure systems over the world's oceans produce strong equatorward flow along the west coasts of continents. This feature is most pronounced off the coast of California and Portugal in the

Northern Hemisphere and along Chile, western Australia, and southwest Africa in the Southern Hemisphere. Very rough seas are generated and are considered a definite factor in route selection or diversion when transiting these areas.

4107. Types of Recommendations and Advisories

A **preliminary route recommendation** is issued to a ship more than ten days prior to sailing, then updated two days prior to sailing based on short to medium range dynamic forecasts. Preliminary route recommendations are a composite representation of experience, climatology, weather and sea state forecasts, the vessel's mission and operational concerns, and the vessel's seagoing characteristics. The U.S. Navy normally requires its units to provide a transit proposal 30 to 45 days prior to sailing, which is vetted through the OTSR program. These transit proposals are based on smart climatology, ship type, mission and environmental limits. All long range planning routes are based more on seasonal and climatological expectations than the current weather situation. Surveillance is a continuous process and these routes are subject to revision prior to sailing if weather and sea conditions dictate

Adjustment of departure time is a recommendation for delay in departure, or early departure if feasible, and is intended to avoid or significantly reduce the adverse weather and seas forecast on the first portion of the route, if sailing on the original EDD. The initial route is not revised, only the timing of the ship's transit through an area with currently unfavorable weather conditions. Adjusting the departure time is an effective method of avoiding a potentially hazardous situation where there is no optimum route for sailing at the originally scheduled time. A go/no go recommendation may be made to vessels engaged in special missions such as speed record attempts or heavy-lift voyages.

A **diversion** is an underway adjustment in track and is intended to avoid or limit the effect of adverse weather conditions forecast to be encountered along the ship's current track, or to take advantage of favorable conditions along another route. Ship's speed is expected to be reduced by the encounter with the heavy weather. In most cases the distance to destination is increased in attempting to avoid the adverse weather, but this is partially overcome by being able to maintain a nearly normal SOA.

Adjustment of SOA is a recommendation for slowing or increasing the ship's speed as much as practicable, in an attempt to avoid an adverse weather situation by adjusting the timing of the encounter. This is also an effective means of maintaining maximum ship operating efficiency, while not diverting from the present ship's track. By adjusting the SOA, a major weather system can sometimes be avoided with no increase in distance. The development of fast ships (SOA greater than 30 knots) gives the ship routing agency the potential to "make the ship's weather" by adjusting the ship's speed and track for encounter with favorable weather conditions.

Evasion is a recommendation to the vessel to take independent action to avoid, as much as possible, a potentially dangerous weather system. The ship routing meteorologist may recommend a general direction for safe evasion but does not specify an exact track. The recommendation for evasion is an indication that the weather and sea conditions have deteriorated to a point where shiphandling and safety are the primary considerations and progress toward destination has been temporarily suspended, or is at least of secondary consideration.

A **weather advisory** is a transmission sent to the ship advising the commanding officer or master of expected adverse conditions, their duration, and geographic extent. It is initiated by the ship routing agency as a service and an aid to the ship. The best example of a situation for which a forecast is helpful is when the ship is currently in good weather but adverse weather is expected within 48 hours for which a diversion has not been recommended, or a diversion where adverse weather conditions are still expected. This type of advisory may include a synoptic weather discussion and a wind, seas or fog forecast.

The ability of the routing agency to achieve optimum conditions for the ship is aided by the commanding officer or master adjusting course and speed where necessary for an efficient and safe ride. At times, the local sea conditions may dictate that the commanding officer or master take independent action.

4108. Southern Hemisphere Routing

Available data on which to base analyses and forecasts is generally very limited in the Southern Hemisphere, although this situation is improving with the increasing availability of remotely sensed data. Weather and other environmental information obtained from satellites is contributing greatly to an improvement in southern hemisphere forecast products.

Passages south of the Cape of Good Hope and Cape Horn should be timed to avoid heavy weather as much as possible, since intense and frequent low pressure systems are common in these areas. In particular, near the southeast coasts of Africa and South America, intense low pressure systems form in the lee of relatively high terrain near the coasts of both continents. Winter transits south of Cape Horn are difficult, since the time required for transit is longer than the typical interval between storms. Remaining equatorward of about 35°S as much as practicable will limit exposure to adverse conditions. If the frequency of lows passing these areas is once every three or four days, the probability of encountering heavy weather is high.

Tropical cyclones in the Southern Hemisphere present a significant problem because of the sparse surface and upper air observations from which forecasts can be made. Satellites provide the most reliable means by which to obtain accurate positions of tropical systems, and also give the first indication of tropical cyclone formation.

In the Southern Hemisphere, OTSR and other ship

weather routing services are available, but are hampered by sparse data reports from which reliable short and extended range forecasts can be produced. Strong climatological consideration is usually given to any proposed southern hemisphere transit, but satellite data is increasingly available to enhance short and extended range forecasts. OTSR procedures for the Northern Hemisphere can be instituted in the Southern Hemisphere whenever justified by basic data input and available forecast models.

4109. Communications

A vital part of a ship routing service is communication between the ship and the routing agency. Reports from the ship show the progress and ability to proceed in existing conditions. Weather reports from the ship enrich the basic data on which analyses are based and forecasts derived, assisting both the reporting ship and others in the vicinity.

Despite all efforts to achieve the best forecasts possible, the quality of forecasts does not always warrant maintaining the route selected. In the U.S. Navy's ship routing program, experience shows that one-third of the ships using OTSR receive some operational or weather-dependent change while underway.

The routing agency needs reports of the ship's position and the ability to transmit recommendations for track change or weather advisories to the ship. The ship needs both send and receive capability for the required information. Information on seakeeping changes initiated by the ship is desirable in a coordinated effort to provide optimum transit conditions. New satellite communications services are making possible the transmission of larger amounts of data than possible through traditional radio messages, a development which supports systems using on-board analysis to generate routes.

4110. Benefits

The benefits of ship weather routing services are primarily in time and cost reductions and increased safety. The savings in operating costs are derived from reductions in transit time, heavy weather encounters, fuel consumption, cargo and hull damage, and more efficient scheduling of dockside activities. The savings are further increased by fewer emergency repairs, more efficient use of personnel, improved topside working conditions, lower insurance rates because of reduced risks under weather routing, and ultimately, extended ship operating life.

An effective routing service maximizes safety by greatly reducing the probability of severe or catastrophic damage to the ship, and injury of crew members. The efficiency and health of the crew is also enhanced by avoiding heavy weather. This is especially important on modern, automated ships with reduced crews and smaller craft such as fishing vessels and yachts.

4111. Conclusion

The success of ship weather routing depends upon the validity of forecasts and the routing agency's ability to make appropriate route recommendations and diversions. Anticipated improvements in a routing agency's recommendations will come from advancements in meteorology, technology, and the application of ocean wave forecast models. Advancements in mathematical meteorology, coupled with the continued application of forecast computer models, will extend the time range and accuracy of the dynamic and statistical forecasts. Additionally, a better understanding of the problems encountered by the mariner and their implications while offshore will assist the routing agency in making appropriate recommendations.

Technological advancements in the areas of satellite and automated communications and onboard ship response systems will increase the amount and type of information to and from the ship with fewer delays. Mariners will have a better quality of meteorological information, and the meteorologists will have a better understanding of the problems, constraints, and priorities of the vessel's masters. Ship response and performance data included with the ship's weather report will provide the routing agency with real-time information with which to ascertain the actual state of the ship. Being able to predict a ship's response in most weather and sea conditions will result in improved routing procedures.

Shipboard and anchored wave measuring devices contribute to the development of ocean wave analysis and

forecast models. Shipboard seakeeping instrumentation, with input of measured wave conditions and predetermined ship response data for the particular hull, enables a master or commanding officer to adjust course and speed for actual conditions.

Modern ship designs, exotic cargoes, and sophisticated transport methods require individual attention to each ship's areas of vulnerability. Any improvement in the description of sea conditions by ocean wave models will improve the output from ship routing and seakeeping systems.

Advanced planning of a proposed transit, combined with the study of expected weather conditions, both before and during the voyage, as is done by ship routing agencies, and careful on board attention to seakeeping (with instrumentation if available) provide the greatest opportunity to achieve the goal of optimum environmental conditions for ocean transit.

4112. References

Kanamitsu, M., Ebisuzaki, W., Woollen, J., Yang, S. K., Hnilo, J. J., Fiorino, M. and Potter, G. L. (2002). *NCEP-DOE AMIP-II Reanalysis (R-2)*, Bull. Amer. Meteor. Soc., 83, 1631-1643.

Knapp, K. R., Kruk, M. C., Levinson, D. H., Diamond, H. J. and Neumann, C. J. (2010). The International Best Track Archive for Climate Stewardship (IBTrACS): *Unifying Tropical Cyclone Best Track Data*. Bull. Amer. Meteor. Soc., 91, 363-376. doi:10.1175/2009BAMS2755.1

THE WORLD SAILING SHIP ROUTES

PREPARED BY REAR ADMIRAL BOYLE T. SOMERVILLE, C.M.G.

NOTES

The routes were those generally used by Sailing Ships on Ocean Voyages during the Sailing Ship Era. Short or coasting voyages are not shown, nor voyages mainly or entirely to windward (for example, from Bombay to Aden in the S.W. Monsoon) as these were seldom made by Sailing Ships.

North-going routes are tinted Brown
South-going routes are tinted Purple
East-going routes are tinted Blue
West-going routes are tinted Magenta

The coloured route zones indicate by their breadth the limits between which tracks were usually made. Where the route between two ports changes according to the season, the track for the appropriate period is named. The "alternative" tracks shown are those preferred by some navigators, instead of the routes in general use.

The routes shown are based on general experience but owing to the variability of winds and currents in all latitudes it may be necessary to depart from the tracks recommended here.

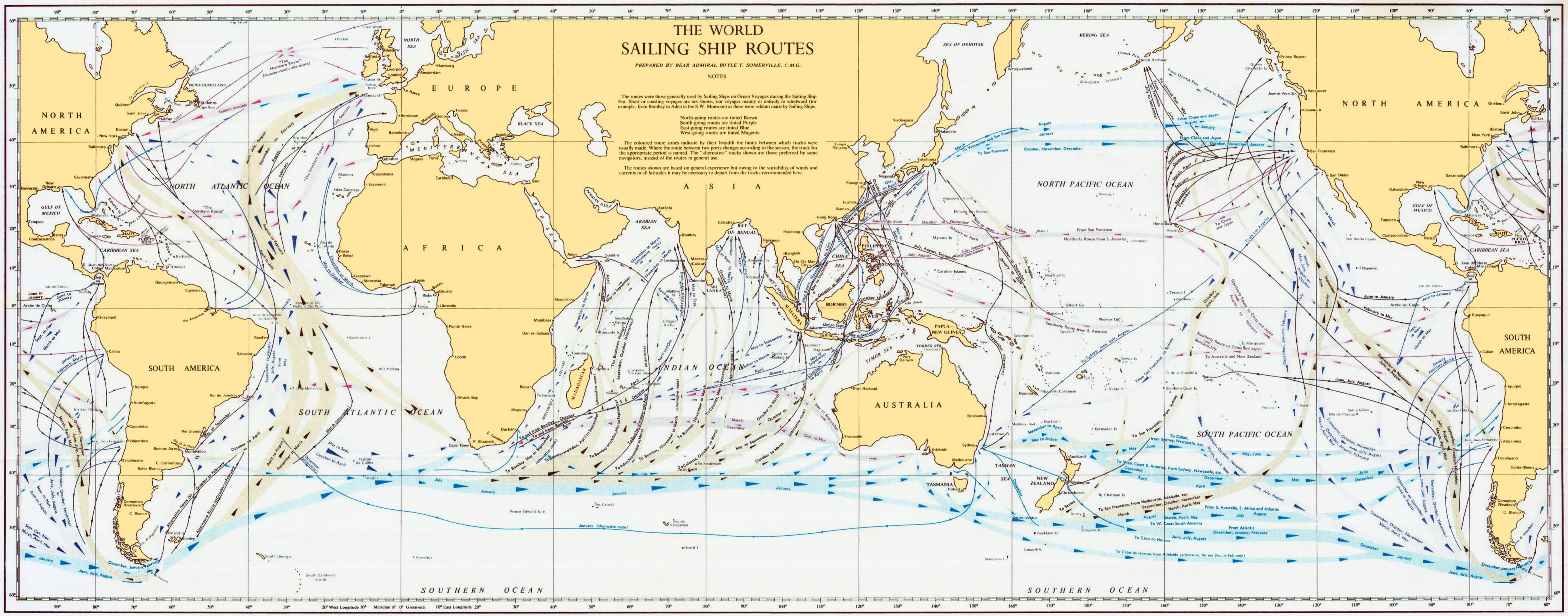

APPENDIX B

CALCULATIONS AND CONVERSIONS

INTRODUCTION

App B 1. Purpose and Scope

This chapter discusses the use of calculators and computers in navigation and summarizes the formulas the navigator depends on during voyage planning, piloting, celestial navigation, and various related tasks. To fully utilize this chapter, the navigator should be competent in basic mathematics including algebra and trigonometry (See Chapter 1 - Mathematics in Volume II) and be familiar with the use of a basic scientific calculator. The navigator should choose a calculator based on personal needs, which may vary greatly from person to person according to individual abilities and responsibilities.

App B 2. Use of Calculators in Navigation

Any common calculator can be used in navigation, even one providing only the four basic arithmetic functions of addition, subtraction, multiplication, and division. Any good scientific calculator can be used for sight reduction, sailings, and other tasks. However, the use computer applications and handheld calculators specifically designed for navigation will greatly reduce the workload of the navigator, reduce the possibility of errors, and assure accuracy of the results calculated.

Calculations of position based on celestial observations have become increasingly uncommon since the advent of GPS as a dependable position reference for all modes of navigation. This is especially true since GPS units provide worldwide positioning with far greater accuracy and reliability than celestial navigation.

However, for those who use celestial techniques, a celestial navigation calculator or computer application can improve celestial position accuracy by easily solving numerous sights, and by reducing mathematical and tabular errors inherent in the manual sight reduction process. They can also provide weighted plots of the LOP's from any number of celestial bodies, based on the navigator's subjective analysis of each sight, and calculate the best fix with latitude/longitude readout.

In using a calculator for any navigational task, it is important to remember that the accuracy of the result, even if carried out many decimal places, is only as good as the least accurate entry. If a sextant observation is taken to an accuracy of only a minute, that is the best accuracy of the final

solution, regardless the calculator's ability to solve to 12 decimal places. See Chapter 3 - Navigational Error in Volume II for a discussion of the sources of error in navigation.

Some basic calculators require the conversion of degrees, minutes and seconds (or tenths) to decimal degrees before solution. A good navigational calculator, however, should permit entry of degrees, minutes and tenths of minutes directly, and should do conversions automatically. Though many non-navigational computer programs have an on-screen calculator, they are generally very simple versions with only the four basic arithmetical functions. They are thus too simple for complex navigational problems. Conversely, a good navigational computer program requires no calculator per se, since the desired answer is calculated automatically from the entered data.

The following articles discuss calculations involved in various aspects of navigation.

App B 3. Calculations of Piloting

- **Hull speed in knots** is found by:

$$S = 1.34\sqrt{\text{waterline length (in feet)}}$$

This is an approximate value which varies with hull shape.

- **Nautical and U.S. survey miles** can be interconverted by the relationships:

$$1 \text{ nautical mile} = 1.15077945 \text{ U.S. survey miles.}$$

$$1 \text{ U.S. survey mile} = 0.86897624 \text{ nautical miles.}$$

- **The speed of a vessel over a measured mile** can be calculated by the formula:

$$S = \frac{3600}{T}$$

where S is the speed in knots and T is the time in seconds.

- **The distance traveled at a given speed** is computed

by the formula:

$$D = \frac{ST}{60}$$

where D is the distance in nautical miles, S is the speed in knots, and T is the time in minutes.

- **Distance to the visible horizon in nautical miles** can be calculated using the formula:

$$D = 1.17 \sqrt{h_f}, \text{ or}$$

$$D = 2.07 \sqrt{h_m}$$

depending upon whether the height of eye of the observer above sea level is in feet (h_f) or in meters (h_m).

- **Dip of the visible horizon in minutes of arc** can be calculated using the formula:

$$D = 0.97' \sqrt{h_f}, \text{ or}$$

$$D = 1.76' \sqrt{h_m}$$

depending upon whether the height of eye of the observer above sea level is in feet (h_f) or in meters (h_m).

- **Distance to the radar horizon** in nautical miles can be calculated using the formula:

$$D = 1.22 \sqrt{h_f}, \text{ or}$$

$$D = 2.21 \sqrt{h_m}$$

depending upon whether the height of the antenna above sea level is in feet (h_f) or in meters (h_m).

- **Dip of the sea short of the horizon** can be calculated using the formula:

$$D_s = 60 \tan^{-1} \left(\frac{h_f}{6076.1 d_s} + \frac{d_s}{8268} \right)$$

where D_s is the dip short of the horizon in minutes of arc; h_f is the height of eye of the observer above sea level, in feet and d_s is the distance to the waterline of the object in nautical miles.

- **Distance by vertical angle between the waterline and the top of an object** is computed by solving the right triangle formed between the observer, the top of the object, and the waterline of the object by simple trigonometry. This assumes that the observer is at sea level, the Earth is flat between observer and object,

there is no refraction, and the object and its waterline form a right angle. For most cases of practical significance, these assumptions produce no large errors.

$$D = \sqrt{\frac{\tan^2 a}{0.0002419^2} + \frac{H-h}{0.7349}} - \frac{\tan a}{0.0002419}$$

where D is the distance in nautical miles, a is the corrected vertical angle, H is the height of the top of the object above sea level, and h is the observer's height of eye in feet. The constants (0.0002419 and 0.7349) account for refraction.

App B 4. Tide Calculations

- **The rise and fall of a diurnal tide** can be roughly calculated from the following table, which shows the fraction of the total range the tide rises or falls during flood or ebb.

Hour	Amount of flood/ebb
1	1/12
2	2/12
3	3/12
4	3/12
5	2/12
6	1/12

App B 5. Calculations of Celestial Navigation

Unlike sight reduction by tables, sight reduction by calculator permits the use of nonintegral values of latitude of the observer, and LHA and declination of the celestial body. Interpolation is not needed, and the sights can be readily reduced from any assumed position. Simultaneous, or nearly simultaneous, observations can be reduced using a single assumed position. Using the observer's DR or MPP for the assumed longitude usually provides a better representation of the circle of equal altitude, particularly at high observed altitudes.

- **The dip correction** is computed in the *Nautical Almanac* using the formula:

$$D = 0.97 \sqrt{h}$$

where dip is in minutes of arc and h is height of eye in feet. This correction includes a factor for refraction. The *Air Almanac* uses a different formula intended for air navigation. The differences are of no significance in practical navigation.

- **The computed altitude (H_c)** is calculated using the basic formula for solution of the undivided navigational

triangle:

$$\sin h = \sin L \sin d + \cos L \cos d \cos LHA,$$

in which h is the altitude to be computed (Hc), L is the latitude of the assumed position, d is the declination of the celestial body, and LHA is the local hour angle of the body. Meridian angle (t) can be substituted for LHA in the basic formula.

Restated in terms of the inverse trigonometric function:

$$Hc = \sin^{-1} [(\sin L \sin d) + (\cos L \cos d \cos LHA)].$$

When latitude and declination are of contrary name, declination is treated as a negative quantity. No special sign convention is required for the local hour angle, as in the following azimuth angle calculations.

- **The azimuth angle (Z)** can be calculated using the altitude azimuth formula if the altitude is known. The formula stated in terms of the inverse trigonometric function is:

$$Z = \cos^{-1} \left(\frac{\sin d - (\sin L \sin Hc)}{\cos L \cos Hc} \right)$$

If the altitude is unknown or a solution independent of altitude is required, the azimuth angle can be calculated using the time azimuth formula:

$$Z = \tan^{-1} \left(\frac{\sin LHA}{(\cos L \tan d) - (\sin L \cos LHA)} \right)$$

The sign conventions used in the calculations of both azimuth formulas are as follows: (1) if latitude and declination are of contrary name, declination is treated as a negative quantity; (2) if the local hour angle is greater than 180°, it is treated as a negative quantity.

If the azimuth angle as calculated is negative, add 180° to obtain the desired value.

- **Amplitudes** can be computed using the formula:

$$A = \sin^{-1}(\sin d \sec L)$$

this can be stated as

$$A = \sin^{-1} \left(\frac{\sin d}{\cos L} \right)$$

where A is the arc of the horizon between the prime vertical and the body, L is the latitude at the point of observation, and d is the declination of the celestial body.

App B 6. Calculations of the Sailings

- **Plane sailing** is based on the assumption that the me-

ridian through the point of departure, the parallel through the destination, and the course line form a plane right triangle, as shown in Figure 0.

$$\text{From this: } \cos C = \frac{l}{D}, \sin C = \frac{p}{D}, \text{ and } \tan C = \frac{p}{l}.$$

$$\text{From this: } l = D \cos C, D = l \sec C, \text{ and } p = D \sin C.$$

From this, given course and distance (C and D), the difference of latitude (l) and departure (p) can be found, and given the latter, the former can be found, using simple trigonometry. See Chapter 12 - The Sailings, Volume I.

- **Traverse sailing** combines plane sailings with two or more courses, computing course and distance along a series of rhumb lines. See Chapter 12 - The Sailings, Volume I.

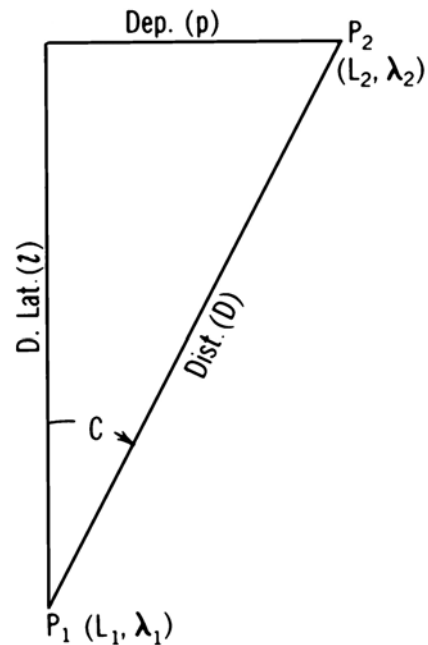

Figure 0. The plane sailing triangle.

- **Parallel sailing** consists of interconverting departure and difference of longitude. Refer to Figure 0.

$$DLo = p \sec L, \text{ and } p = DLo \cos L$$

- **Mid-latitude sailing** combines plane and parallel sailing, with certain assumptions. The mean latitude (Lm) is half of the arithmetical sum of the latitudes of two places on the same side of the equator. For places on opposite sides of the equator, the N and S portions are solved separately.

In mid-latitude sailing:

$$DLo = p \sec Lm, \text{ and } p = DLo \cos Lm$$

- **Mercator Sailing** problems are solved graphically on a Mercator chart. For mathematical Mercator solutions the formulas are:

$$\tan C = \frac{DLo}{m} \text{ or } DLo = m \tan C$$

where m is the meridional part from Table 6 in the Tables Part of this volume. Following solution of the course angle by Mercator sailing, the distance is by the plane sailing formula:

$$D = 1 \sec C.$$

- **Great-circle solutions for distance and initial course angle** can be calculated from the formulas:

$$D = \cos^{-1} [(\sin L_1 \sin L_2 + \cos L_1 \cos L_2 \cos DLo)],$$

and

$$C = \tan^{-1} \left(\frac{\sin DLo}{(\cos L_1 \tan L_2) - (\sin L_1 \cos DLo)} \right)$$

where D is the great-circle distance, C is the initial great-circle course angle, L_1 is the latitude of the point of departure, L_2 is the latitude of the destination, and DLo is the difference of longitude of the points of departure and destination. If the name of the latitude of the destination is contrary to that of the point of departure, it is treated as a negative quantity.

- **The latitude of the vertex**, L_v , is always numerically equal to or greater than L_1 or L_2 . If the initial course angle C is less than 90° , the vertex is toward L_2 , but if C is greater than 90° , the nearer vertex is in the opposite direction. The vertex nearer L_1 has the same name as L_1 .

The latitude of the vertex can be calculated from the formula:

$$L_v = \cos^{-1}(\cos L_1 \sin C)$$

The difference of longitude of the vertex and the point of departure (DLo_v) can be calculated from the formula:

$$DLo_v = \sin^{-1} \left(\frac{\cos C}{\sin L_v} \right).$$

The distance from the point of departure to the vertex (D_v) can be calculated from the formula:

$$D_v = \sin^{-1}(\cos L_1 \sin DLo_v).$$

- **The latitudes of points on the great-circle track** can be determined for equal DLo intervals each side of the vertex (DLo_{vx}) using the formula:

$$L_x = \tan^{-1}(\cos DLo_{vx} \tan L_v)$$

The DLo_v and D_v of the nearer vertex are never greater than 90° . However, when L_1 and L_2 are of contrary name, the other vertex, 180° away, may be the better one to use in the solution for points on the great-circle track if it is nearer the mid point of the track.

The method of selecting the longitude (or DLo_{vx}), and determining the latitude at which the great-circle crosses the selected meridian, provides shorter legs in higher latitudes and longer legs in lower latitudes. Points at desired distances or desired equal intervals of distance on the great-circle from the vertex (D_{vx}) can be calculated using the formulas:

$$L_x = \sin^{-1} [\sin L_v \cos D_{vx}],$$

and

$$DLo_{vx} = \sin^{-1} \left(\frac{\sin D_{vx}}{\cos L_x} \right).$$

A calculator which converts rectangular to polar coordinates provides easy solutions to plane sailings. However, the user must know whether the difference of latitude corresponds to the calculator's X-coordinate or to the Y-coordinate.

App B 7. Calculations Of Meteorology And Oceanography

- **Converting thermometer scales** between centigrade, Fahrenheit, and Kelvin scales can be done using the following formulas:

$$C^\circ = \frac{5(F^\circ - 32^\circ)}{9},$$

$$F^\circ = \frac{9}{5}C^\circ + 32^\circ, \text{ and}$$

$$K^\circ = C^\circ + 273.15^\circ.$$

- Maximum length of sea waves** can be found by the formula:

$$W = 1.5 \sqrt{\text{fetch in nautical miles}}$$
- Wave speed** in knots

$$= 1.34 \sqrt{\text{wavelength in feet}}, \text{ or}$$

$$= 3.03 \times \text{wave period in seconds.}$$
- Wave height** = 0.026 S² where S is the wind speed in knots.

UNIT CONVERSION

Use the conversion tables that appear on the following pages to convert between different systems of units. Conversions followed by an asterisk are exact relationships.

MISCELLANEOUS DATA

Area

1 square inch	= 6.4516 square centimeters*
1 square foot	= 144 square inches*
	= 0.09290304 square meter*
	= 0.000022957 acre
1 square yard	= 9 square feet*
	= 0.83612736 square meter
1 square (statute) mile	= 27,878,400 square feet*
	= 640 acres*
	= 2.589988110336 square kilometers*
1 square centimeter	= 0.1550003 square inch
	= 0.00107639 square foot
1 square meter	= 10.76391 square feet
	= 1.19599005 square yards
1 square kilometer	= 247.1053815 acres
	= 0.38610216 square statute mile
	= 0.29155335 square nautical mile

Astronomy

1 mean solar unit	= 1.00273791 sidereal units
1 sidereal unit	= 0.99726957 mean solar units
1 microsecond	= 0.000001 second*
1 second	= 1,000,000 microseconds*
	= 0.01666667 minute
	= 0.00027778 hour
	= 0.00001157 day
1 minute	= 60 seconds*
	= 0.01666667 hour
	= 0.00069444 day
1 hour	= 3,600 seconds*
	= 60 minutes*
	= 0.04166667 day
1 mean solar day	= 24 ^h 03 ^m 56 ^s .55536 of mean sidereal time
	= 1 rotation of Earth with respect to Sun (mean)*
	= 1.00273791 rotations of Earth
	with respect to vernal equinox (mean)
	= 1.0027378118868 rotations of Earth
	with respect to stars (mean)
1 mean sidereal day	= 23 ^h 56 ^m 04 ^s .09054 of mean solar time
1 sidereal month	= 27.321661 days
	= 27 ^d 07 ^h 43 ^m 11 ^s .5
1 synodical month	= 29.530588 days
	= 29 ^d 12 ^h 44 ^m 02 ^s .8

1 tropical (ordinary) year	$= 31,556,925.975$ seconds $= 525,948.766$ minutes $= 8,765.8128$ hours $= 365^{\text{d}}.24219879 - 0^{\text{d}}.0000000614(t-1900)$, where $t =$ the year (date) $= 365^{\text{d}}05^{\text{h}}48^{\text{m}}46^{\text{s}} (-) 0^{\text{s}}.0053(t-1900)$
1 sidereal year	$= 365^{\text{d}}.25636042 + 0.0000000011(t-1900)$, where $t =$ the year (date) $= 365^{\text{d}}06^{\text{h}}09^{\text{m}}09^{\text{s}}.5 (+) 0^{\text{s}}.0001(t-1900)$
1 calendar year (common)	$= 31,536,000$ seconds* $= 525,600$ minutes* $= 8,760$ hours* $= 365$ days*
1 calendar year (leap)	$= 31,622,400$ seconds* $= 527,040$ minutes* $= 8,784$ hours* $= 366$ days
1 light-year	$= 9,460,000,000,000$ kilometers $= 5,880,000,000,000$ statute miles $= 5,110,000,000,000$ nautical miles $= 63,240$ astronomical units $= 0.3066$ parsecs
1 parsec	$= 30,860,000,000,000$ kilometers $= 19,170,000,000,000$ statute miles $= 16,660,000,000,000$ nautical miles $= 206,300$ astronomical units $= 3.262$ light years
1 astronomical unit	$= 149,600,000$ kilometers $= 92,960,000$ statute miles $= 80,780,000$ nautical miles $= 499^{\text{s}}.012$ light-time $=$ mean distance, Earth to Sun
Mean distance, Earth to Moon	$= 384,400$ kilometers $= 238,855$ statute miles $= 207,559$ nautical miles
Mean distance, Earth to Sun	$= 149,600,000$ kilometers $= 92,957,000$ statute miles $= 80,780,000$ nautical miles $= 1$ astronomical unit
Sun's diameter	$= 1,392,000$ kilometers $= 865,000$ statute miles $= 752,000$ nautical miles
Sun's mass	$= 1,987,000,000,000,000,000,000,000,000,000$ grams $= 2,200,000,000,000,000,000,000,000,000,000$ short tons $= 2,000,000,000,000,000,000,000,000,000,000$ long tons
Speed of Sun relative to neighboring stars	$= 19.4$ kilometers per second $= 12.1$ statute miles per second $= 10.5$ nautical miles per second
Orbital speed of Earth	$= 29.8$ kilometers per second $= 18.5$ statute miles per second $= 16.1$ nautical miles per second
Obliquity of the ecliptic	$= 23^{\circ}27'08''.26 - 0''.4684 (t-1900)$, where $t =$ the year (date)
General precession of the equinoxes	$= 50''.2564 + 0''.000222 (t-1900)$, per year, where $t =$ the year (date)
Precession of the equinoxes in right ascension	$= 46''.0850 + 0''.000279 (t-1900)$, per year, where $t =$ the year (date)
Precession of the equinoxes in declination	$= 20''.0468 - 0''.000085 (t-1900)$, per year, where $t =$ the year (date)

Magnitude ratio _ _ _ _ _ = 2.512
 = $\sqrt[5]{100}$ *

Charts

Nautical miles per inch _ _ _ _ _ = reciprocal of natural scale ÷ 72,913.39
 Statute miles per inch _ _ _ _ _ = reciprocal of natural scale ÷ 63,360*
 Inches per nautical mile _ _ _ _ _ = 72,913.39 × natural scale
 Inches per statute mile _ _ _ _ _ = 63,360 × natural scale*
 Natural scale _ _ _ _ _ = 1:72,913.39 × nautical miles per inch
 = 1:63,360 × statute miles per inch*

Earth

Acceleration due to gravity (standard) _ _ _ _ _ = 980.665 centimeters per second per second
 = 32.1740 feet per second per second
 Mass-ratio—Sun/Earth _ _ _ _ _ = 332,958
 Mass-ratio—Sun/(Earth & Moon) _ _ _ _ _ = 328,912
 Mass-ratio—Earth/Moon _ _ _ _ _ = 81.30
 Mean density _ _ _ _ _ = 5.517 grams per cubic centimeter
 Velocity of escape _ _ _ _ _ = 6.94 statute miles per second
 Curvature of surface _ _ _ _ _ = 0.8 foot per nautical mile

World Geodetic System (WGS) Ellipsoid of 1984

Equatorial radius (a) _ _ _ _ _ = 6,378,137 meters
 = 3,443.918 nautical miles
 Polar radius (b) _ _ _ _ _ = 6,356,752.314 meters
 = 3432.372 nautical miles
 Mean radius (2a + b)/3 _ _ _ _ _ = 6,371,008.770 meters
 = 3440.069 nautical miles
 Flattening or ellipticity (f = 1 - b/a) _ _ _ _ _ = 1/298.257223563
 = 0.003352811
 Eccentricity (e = (2f - f²)^{1/2}) _ _ _ _ _ = 0.081819191
 Eccentricity squared (e²) _ _ _ _ _ = 0.006694380

Length

1 inch _ _ _ _ _ = 25.4 millimeters*
 = 2.54 centimeters*
 1 foot (U.S.) _ _ _ _ _ = 12 inches*
 = 1 British foot
 = $\frac{1}{3}$ yard*
 = 0.3048 meter*
 = $\frac{1}{6}$ fathom*
 1 foot (U.S. Survey) _ _ _ _ _ = 0.30480061 meter
 1 yard _ _ _ _ _ = 36 inches*
 = 3 feet*
 = 0.9144 meter*
 1 fathom _ _ _ _ _ = 6 feet*
 = 2 yards*
 = 1.8288 meters*
 1 cable _ _ _ _ _ = 720 feet*
 = 240 yards*
 = 219.4560 meters*
 1 cable (British) _ _ _ _ _ = 0.1 nautical mile
 1 statute mile _ _ _ _ _ = 5,280 feet*
 = 1,760 yards*
 = 1,609.344 meters*
 = 1.609344 kilometers*
 = 0.86897624 nautical mile
 1 nautical mile _ _ _ _ _ = 6,076.11548556 feet
 = 2,025.37182852 yards
 = 1,852 meters*
 = 1.852 kilometers*
 = 1.150779448 statute miles

1 meter	= 100 centimeters*
	= 39.370079 inches
	= 3.28083990 feet
	= 1.09361330 yards
	= 0.54680665 fathom
	= 0.00062137 statute mile
	= 0.00053996 nautical mile
1 kilometer	= 3,280.83990 feet
	= 1,093.61330 yards
	= 1,000 meters*
	= 0.62137119 statute mile
	= 0.53995680 nautical mile

Mass

1 ounce	= 437.5 grains*
	= 28.349523125 grams*
	= 0.0625 pound*
	= 0.028349523125 kilogram*
1 pound	= 7,000 grains*
	= 16 ounces*
	= 0.45359237 kilogram*
1 short ton	= 2,000 pounds*
	= 907.18474 kilograms*
	= 0.90718474 metric ton*
	= 0.8928571 long ton
1 long ton	= 2,240 pounds*
	= 1,016.0469088 kilograms*
	= 1.12 short tons*
	= 1.0160469088 metric tons*
1 kilogram	= 2.204623 pounds
	= 0.00110231 short ton
	= 0.0009842065 long ton
1 metric ton	= 2,204.623 pounds
	= 1,000 kilograms*
	= 1.102311 short tons
	= 0.9842065 long ton

Mathematics

π	= 3.1415926535897932384626433832795028841971
π^2	= 9.8696044011
$\sqrt{\pi}$	= 1.7724538509
Base of Naperian logarithms (e)	= 2.718281828459
Modulus of common logarithms ($\log_{10}e$)	= 0.4342944819032518
1 radian	= 206,264."80625
	= 3,437'.7467707849
	= 57°.2957795131
	= 57°17'44".80625
1 circle	= 1,296,000"*
	= 21,600'*
	= 360°*
	= 2π radians*
180°	= π radians*
1°	= 3600"*
	= 60'*
	= 0.0174532925199432957666 radian
1'	= 60"*
	= 0.000290888208665721596 radian
1"	= 0.000004848136811095359933 radian
Sine of 1'	= 0.00029088820456342460
Sine of 1"	= 0.00000484813681107637

Meteorology

Atmosphere (dry air)	
Nitrogen	= 78.08%
Oxygen	= 20.95%
Argon	= 0.93%
Carbon dioxide	= 0.03%
Neon	= 0.0018%
Helium	= 0.000524%
Krypton	= 0.0001%
Hydrogen	= 0.00005%
Xenon	= 0.0000087%
Ozone	= 0 to 0.000007% (increasing with altitude)
Radon	= 0.000000000000000006% (decreasing with altitude)
Standard atmospheric pressure at sea level	= 1,013.250 dynes per square centimeter
	= 1,033.227 grams per square centimeter
	= 1,033.227 centimeters of water
	= 1,013.250 hectopascals (millibars)*
	= 760 millimeters of mercury
	= 76 centimeters of mercury
	= 33.8985 feet of water
	= 29.92126 inches of mercury
	= 14.6960 pounds per square inch
	= 1.033227 kilograms per square centimeter
	= 1.013250 bars*
Absolute zero	= (-)273.16°C
	= (-)459.69°F

Pressure

1 dyne per square centimeter	= 0.001 hectopascal (millibar)*
	= 0.000001 bar*
1 gram per square centimeter	= 1 centimeter of water
	= 0.980665 hectopascal (millibar)*
	= 0.07355592 centimeter of mercury
	= 0.0289590 inch of mercury
	= 0.0142233 pound per square inch
	= 0.001 kilogram per square centimeter*
	= 0.000967841 atmosphere
1 hectopascal (millibar)	= 1,000 dynes per square centimeter*
	= 1.01971621 grams per square centimeter
	= 0.7500617 millimeter of mercury
	= 0.03345526 foot of water
	= 0.02952998 inch of mercury
	= 0.01450377 pound per square inch
	= 0.001 bar*
	= 0.00098692 atmosphere
1 millimeter of mercury	= 1.35951 grams per square centimeter
	= 1.3332237 hectopascals (millibars)
	= 0.1 centimeter of mercury*
	= 0.04460334 foot of water
	= 0.039370079 inch of mercury
	= 0.01933677 pound per square inch
	= 0.001315790 atmosphere
1 centimeter of mercury	= 10 millimeters of mercury*
1 inch of mercury	= 34.53155 grams per square centimeter
	= 33.86389 hectopascals (millibars)
	= 25.4 millimeters of mercury*
	= 1.132925 feet of water
	= 0.4911541 pound per square inch
	= 0.03342106 atmosphere
1 centimeter of water	= 1 gram per square centimeter
	= 0.001 kilogram per square centimeter
1 foot of water	= 30.48000 grams per square centimeter
	= 29.89067 hectopascals (millibars)
	= 2.241985 centimeters of mercury
	= 0.882671 inch of mercury
	= 0.4335275 pound per square inch
	= 0.02949980 atmosphere

1 pound per square inch_ _ _ _ _	= 68,947.57 dynes per square centimeter = 70.30696 grams per square centimeter = 70.30696 centimeters of water = 68.94757 hectopascals (millibars) = 51.71493 millimeters of mercury = 5.171493 centimeters of mercury = 2.306659 feet of water = 2.036021 inches of mercury = 0.07030696 kilogram per square centimeter = 0.06894757 bar = 0.06804596 atmosphere
1 kilogram per square centimeter _ _ _ _ _	= 1,000 grams per square centimeter* = 1,000 centimeters of water
1 bar _ _ _ _ _	= 1,000,000 dynes per square centimeter* = 1,000 hectopascals (millibars)*

Speed

1 foot per minute _ _ _ _ _	= 0.01666667 foot per second = 0.00508 meter per second*
1 yard per minute _ _ _ _ _	= 3 feet per minute* = 0.05 foot per second* = 0.03409091 statute mile per hour = 0.02962419 knot = 0.01524 meter per second*
1 foot per second _ _ _ _ _	= 60 feet per minute* = 20 yards per minute* = 1.09728 kilometers per hour* = 0.68181818 statute mile per hour = 0.59248380 knot = 0.3048 meter per second*
1 statute mile per hour _ _ _ _ _	= 88 feet per minute* = 29.33333333 yards per minute = 1.609344 kilometers per hour* = 1.46666667 feet per second = 0.86897624 knot = 0.44704 meter per second*
1 knot _ _ _ _ _	= 101.26859143 feet per minute = 33.75619714 yards per minute = 1.852 kilometers per hour* = 1.68780986 feet per second = 1.15077945 statute miles per hour = 0.51444444 meter per second
1 kilometer per hour _ _ _ _ _	= 0.62137119 statute mile per hour = 0.53995680 knot
1 meter per second _ _ _ _ _	= 196.85039340 feet per minute = 65.6167978 yards per minute = 3.6 kilometers per hour* = 3.28083990 feet per second = 2.23693632 statute miles per hour = 1.94384449 knots
Light in vacuum_ _ _ _ _	= 299,792.5 kilometers per second = 186,282 statute miles per second = 161,875 nautical miles per second = 983.570 feet per microsecond
Light in air _ _ _ _ _	= 299,708 kilometers per second = 186,230 statute miles per second = 161,829 nautical miles per second = 983.294 feet per microsecond
Sound in dry air at 59°F or 15°C and standard sea level pressure _ _ _ _ _	= 1,116.45 feet per second = 761.22 statute miles per hour = 661.48 knots = 340.29 meters per second

Sound in 3.485 percent saltwater at 60°F _ _ _ = 4,945.37 feet per second
 = 3,371.85 statute miles per hour
 = 2,930.05 knots
 = 1,507.35 meters per second

Volume

1 cubic inch _ _ _ _ _ = 16.387064 cubic centimeters*
 = 0.016387064 liter*
 = 0.004329004 gallon

1 cubic foot _ _ _ _ _ = 1,728 cubic inches*
 = 28.316846592 liters*
 = 7.480519 U.S. gallons
 = 6.228822 imperial (British) gallons
 = 0.028316846592 cubic meter*

1 cubic yard _ _ _ _ _ = 46,656 cubic inches*
 = 764.554857984 liters*
 = 201.974026 U.S. gallons
 = 168.1782 imperial (British) gallons
 = 27 cubic feet*
 = 0.764554857984 cubic meter*

1 milliliter _ _ _ _ _ = 0.06102374 cubic inch
 = 0.0002641721 U.S. gallon
 = 0.00021997 imperial (British) gallon

1 cubic meter _ _ _ _ _ = 264.172035 U.S. gallons
 = 219.96878 imperial (British) gallons
 = 35.31467 cubic feet
 = 1.307951 cubic yards

1 quart (U.S.) _ _ _ _ _ = 57.75 cubic inches*
 = 32 fluid ounces*
 = 2 pints*
 = 0.9463529 liter
 = 0.25 gallon*

1 gallon (U.S.) _ _ _ _ _ = 3,785.412 milliliters
 = 231 cubic inches*
 = 0.1336806 cubic foot
 = 4 quarts*
 = 3.785412 liters
 = 0.8326725 imperial (British) gallon

1 liter _ _ _ _ _ = 1,000 milliliters
 = 61.02374 cubic inches
 = 1.056688 quarts
 = 0.2641721 gallon

1 register ton _ _ _ _ _ = 100 cubic feet*
 = 2.8316846592 cubic meters*

1 measurement ton _ _ _ _ _ = 40 cubic feet*
 = 1 freight ton*

1 freight ton _ _ _ _ _ = 40 cubic feet*
 = 1 measurement ton*

Volume-Mass

1 cubic foot of seawater _ _ _ _ _ = 64 pounds
 1 cubic foot of freshwater _ _ _ _ _ = 62.428 pounds at temperature of maximum density (4°C = 39°.2F)
 1 cubic foot of ice _ _ _ _ _ = 56 pounds
 1 displacement ton _ _ _ _ _ = 35 cubic feet of seawater*
 = 1 long ton

**Prefixes to Form Decimal Multiples and Sub-Multiples
of International System of Units (SI)**

Multiplying factor	Prefix	Symbol
1 000 000 000 000 = 10 ¹²	tera	T
1 000 000 000 = 10 ⁹	giga	G
1 000 000 = 10 ⁶	mega	M
1 000 = 10 ³	kilo	k
100 = 10 ²	hecto	h
10 = 10 ¹	deka	da
0.1 = 10 ⁻¹	deci	d
0.01 = 10 ⁻²	centi	c
0.001 = 10 ⁻³	milli	m
0.000 001 = 10 ⁻⁶	micro	μ
0.000 000 001 = 10 ⁻⁹	nano	n
0.000 000 000 001 = 10 ⁻¹²	pico	p
0.000 000 000 000 001 = 10 ⁻¹⁵	femto	f
0.000 000 000 000 000 001 = 10 ⁻¹⁸	atto	a

NGA MARITIME SAFETY INFORMATION NAUTICAL CALCULATORS

NGA's **Maritime Safety Office website** offers a variety of online Nautical Calculators for public use. These calculators solve many of the equations and conversions typically associated with marine navigation. See the link provided in Figure 0.



Figure 0. Link to NGA Nautical Calculators.

https://msi.nga.mil/NGAPortal/MSI.portal;jsessionid=LdlrYH9GQx4F5ThpnLCrz7qQ0r5y7gvQQMqTcm1cQvxt8VRLy1bN!1949651045!2018399300?_nfpb=true&_st=&_pageLabel=msi_portal_page_145

List of NGA Maritime Safety information Nautical Calculators <https://msi.nga.mil>

Celestial Navigation Calculators
Compass Error from Amplitudes Observed on the Visible Horizon
Altitude Correction for Air Temperature
Table of Offsets
Latitude and Longitude Factors
Altitude Corrections for Atmospheric Pressure
Altitude Factors & Change of Altitude

List of NGA Maritime Safety information Nautical Calculators <https://msi.nga.mil>

Pub 229
Compass Error from Amplitudes observed on the Celestial Horizon
Conversion Calculators
Chart Scales and Conversions for Nautical and Statute Miles
Conversions for Meters, Feet and Fathoms
Distance Calculators
Length of a Degree of Latitude and Longitude
Speed for Measured Mile and Speed, Time and Distance
Distance of an Object by Two Bearings
Distance of the Horizon
Distance by Vertical Angle Measured Between Sea Horizon and Top of Object Beyond Sea Horizon
Traverse Table
Geographic Range
Distance by Vertical Angle Measured Between Waterline at Object and Top of Object
Dip of Sea Short of the Horizon
Distance by Vertical Angle Measured Between Waterline at Object and Sea Horizon Beyond Object
Meridional Parts
Log and Trig Calculators
Logarithmic and Trigonometric Functions
Sailings Calculators
Great Circle Sailing
Mercator NGA Sailing
Time Zones Calculators
Time Zones, Zone Descriptions and Suffixes
Weather Data Calculators
Direction and Speed of True Wind
Correction of Barometer Reading for Height Above Sea Level
Correction of Barometer Reading for Gravity
Temperature Conversions
Relative Humidity and Dew Point
Corrections of Barometer Reading for Temperature
Barometer Measurement Conversions

APPENDIX C

SATELLITE NAVIGATION

GPS SIGNAL CODING

App C 001. The GPS L1 Band

The GPS L1 band (1575.42 MHz) has turned out to be the most important band for navigation purposes. Indeed most of the applications in the world nowadays are based on the signals transmitted at this frequency. Three signals are transmitted at the moment by GPS in L1: C/A Code, P(Y) Code and M-Code. In the future, an additional new civil signal, known as L1C, will also be transmitted. We describe all of them in the next lines:

- The Coarse/Acquisition (C/A) code signal was primarily thought of for acquisition of the P (or Y) code and has become nowadays the most important signal for mass market applications.
- The P Code is the precision signal and is coded by the precision code. Moreover the Y-Code is used in place of the P-code whenever the Anti-Spoofing (A/S) mode of operation is activated as described in the GPS ICDs 203, 224 and 225.
- The modernized military signal (M-Code) is designed exclusively for military use and is intended to eventually replace the P(Y) code [E. D. Kaplan and C. Hegarty, 2006]. The M-Code provides better jamming resistance than the P(Y) signal, primarily through enabling transmission at much higher power

without interference with C/A code or P(Y) code receivers [B.C. Barker et al., 2000]. Moreover, the M-Code provides more robust signal acquisition than is achieved today, while offering better security in terms of exclusivity, authentication, and confidentiality, along with streamlined key distribution. In other aspects, the M-Code signal provides much better performance than the P(Y) Code and more flexibility.

- The L1 Civil signal (L1C), defined in the [GPS ICD-800], consists of two main components; one denoted $L1C_P$ to represent the pilot signal, consisting of a time-multiplexing of Binary Offset Carrier BOC(1,1) and BOC(6,1), thus without any data message, and $L1C_D$ with a pure BOC(1,1), for the data channel. This is spread by a ranging code and modulated by a data message. The pilot channel $L1C_P$ is also modulated by an SV unique overlay secondary code, $L1C_O$.

For more details on the code generation refer to the [GPS ICD 200] and [GPS ICD-800]. Finally, the technical characteristics of the existing and planned GPS signals in the L1 band are summarized in the following Table 0.

GNSS System	GPS	GPS		GPS	GPS
Service Name	C/A	L1C		P(Y) Code	M-Code
Center Frequency	1575.42 MHz	1575.42 MHz		1575.42 MHz	1575.42 MHz
Frequency Band	L1	L1		L1	L1
Access Technique	CDMA	CDMA		CDMA	CDMA
Signal Component	Data	Data	Pilot	Data	N/A
Modulation	BPSK(1)	TMBOC(6,1,1/11)		BPSK(10)	BOC _{sin} (10,5)
Sub-carrier Frequency [MHz]	-	1.023	1.023 & 6.138	-	10.23
Code Frequency	1.023 MHz	1.023 MHz		10.23 MHz	5.115 MHz
Primary PRN Code Length	1023	10230		6.19×10^{12}	N/A
Code Family	Gold Codes	Weil Codes		Combo and short cycling of M-sequences	N/A

Table 0. GPS L1 signal technical characteristics.

GNSS System	GPS	GPS		GPS	GPS
Secondary PRN Code Length	-	-	1800	-	N/A
Data Rate	50 bps/ 50 sps	50 bps/ 100 sps	-	50 bps/ 50 sps	N/A
Minimum Received Power [dBW]	-158.5	-157		-161.5	N/A
Elevation	5°	5°		5°	5°

Table 0. GPS L1 signal technical characteristics.

Of all the signals shown in Table 0, the C/A Code is the best known as most of the receivers that have been built until today are based on it. The C/A Code was open from the very beginning to all users, although until May 1, 2000, an artificial degradation was introduced by means of the **Select Availability (SA)** mechanism which added an intentional distortion to degrade the positioning quality of the signal to non-desired users. As we have already mentioned, the C/A Code was thought to be an aid for the P(Y) Code (to realize a Coarse Acquisition). The M-Code is the last military signal that has been introduced in GPS.

For a long time different signal structures for the M-Code were under consideration [J.W. Betz, 2001] being the Manchester code signals - **Binary Phase Shift Keying (BPSK)** and the **binary offset carrier (BOC)** signals the two favored candidates. Both solutions result from the modulation of a non-return to zero (NRZ) pseudo random noise spreading code by a square-wave sub-carrier. While the Manchester code has a spreading code of rate equal to that of the square-wave, the BOC signal does not necessarily have to be so, being the only constraint that the rate of the spreading code must be less than the sub-carrier frequency.

The interesting aspect about these signals is that, like the conventional sub-carrier modulation, the waveform presents a zero at the carrier frequency due to the square-wave sub-carrier. In fact, their split-power spectra clearly facilitate the compatibility of the GPS military M-Code signal with the existing C/A Code and P(Y) Code. See Figure 0a - *Spectra of GPS signals in L1*.

We can clearly recognize that GPS L1C concentrates more power at higher frequencies - due to BOC(6,1) - in the pilot channel than in the data channel.

Finally, it is important to note that for all the figures next the commonly used expressions for bandwidths in MHz must be understood as multiplied by the factor 1.023. Thus BPSK(10) refers in reality to a BPSK signal with a chip rate of 10.23 MHz. This remains valid for all the bandwidths in this thesis, unless different stated otherwise

App C 002. The GPS L2 Band

GPS is transmitting in the L2 band (1227.60 MHz) a modernized civil signal known as L2C together with the P(Y) Code and the M-Code. The P(Y) Code and M-Code were already described shortly in the previous chapter and the properties and parameters are thus similar to those in the L1 band. In addition, for Block IIR-M, IIF, and subsequent blocks of SVs, two additional PRN ranging codes will be transmitted. They are the L2 Civil Moderate (L2 CM) code and the L2 Civil Long (L2 CL) code. These two signals are time multiplexed so that the resulting chipping rate is double as high as that of each individual signal. We further describe them in the next lines more in detail:

- L2 CM Code is transmitted in the IIR-M, IIF, and subsequent blocks. The PRN L2 CM Code for SV number i is a ranging code, $CM_i(t)$, which is 20 milliseconds in length at a chipping rate of 511.5 Kbps. The epochs of the L2 CM Code are synchronized with the X1 epochs of the P-code. The $CM_i(t)$ sequence is a linear pattern which is short cycled every count period of 10,230 chips by resetting with a particular initial state. Furthermore, for Block IIR-M, the navigation data is also Modulo-2 added to the L2 CM Code. It is interesting to note that the navigation data can be used in one of two different data rates selectable by ground command: 1) D(t) with a data rate of 50 bps, or 2) D(t) with a symbol rate of 50 symbols per second (sps) which is obtained by encoding D(t) with a data rate of 25 bps coded in a rate 1/2 convolutional code. Finally, the resultant bit-train is combined with the L2 CL Code using time-division multiplexing.
- L2 CL Code is transmitted in the IIR-M, IIF, and subsequent blocks. The PRN L2 CL Code for SV number i is a ranging code, $CL_i(t)$, which is 1.5 seconds in length at a chipping rate of 511.5 Kbps. The epochs of the L2 CL Code are synchronized with the X1 epochs of the P Code. The $CL_i(t)$ sequence is a linear pattern which is generated using the same code generator polynomial as of $CM_i(t)$. However, the $CM_i(t)$ sequence is short cycled by resetting with an initial state every count period of

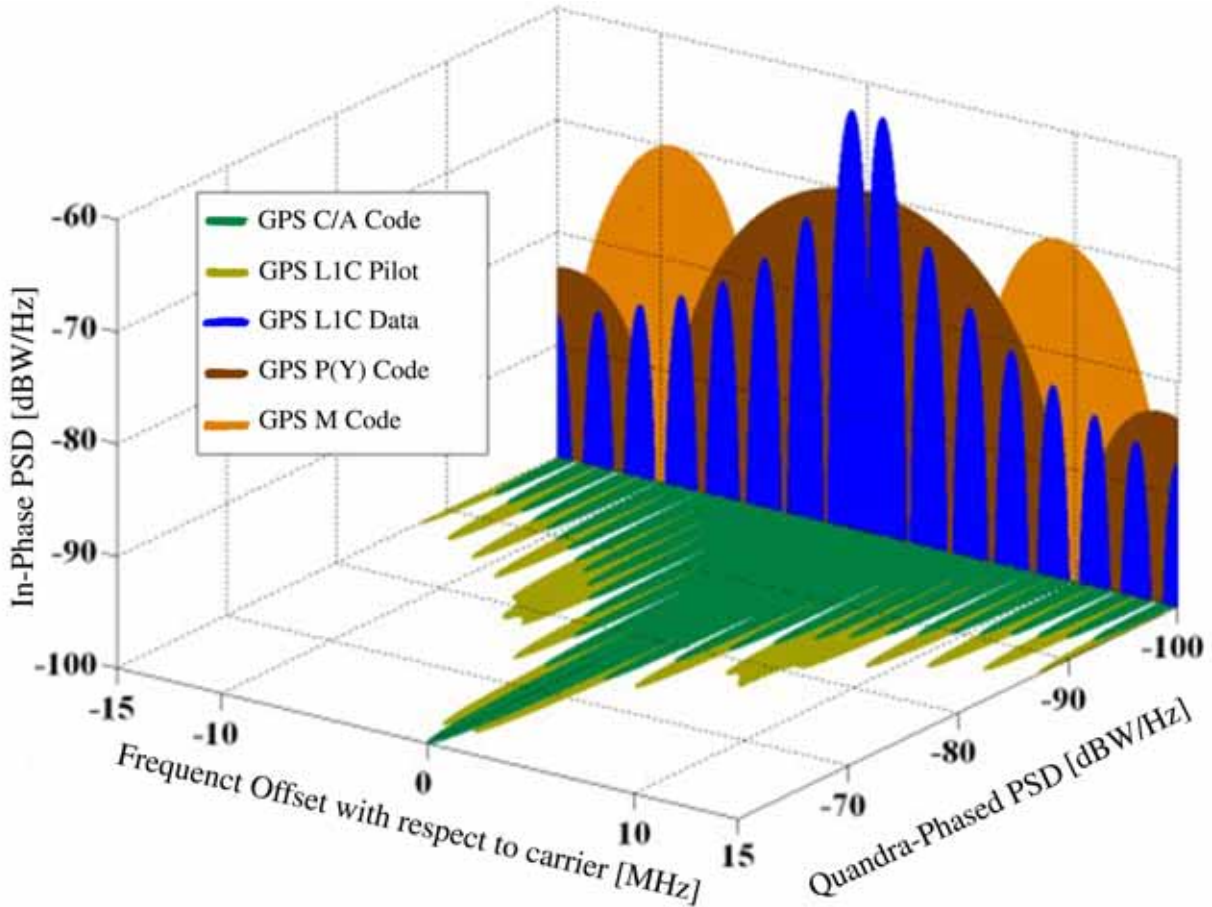

Figure 0a. Spectra of GPS signals in L1. Image courtesy of Dr. Jose Angel Avila Rodriguez.

767,250 chips.

Finally, it is important to note that the GPS L2 band will have a transition period from the C/A Code to L2C and mixed configurations could occur. Figure 0b shows the baseband L2 signal generation scheme. As we can recog-

nize, although the chipping rate of the L2 CM and L2 CL signals is of 511.5 Kbps individually, after the time multiplexing the composite signal results in a stream of 1.023 MHz.

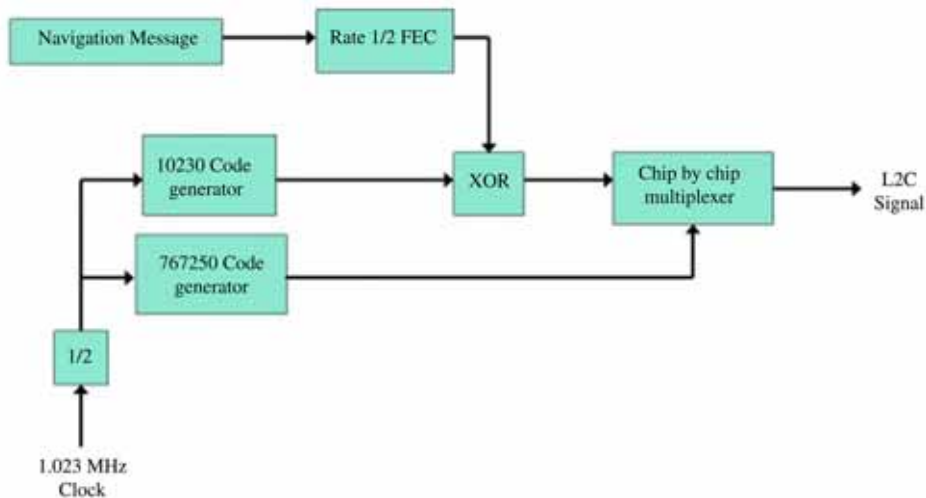

Figure 0b. Modulation scheme for the GPS L2 signals. Image courtesy of Dr. Jose Angel Avila Rodriguez.

The technical characteristics of the GPS L2 signals are summarized in Table 0a and the spectra of the different signals (L2C, P(Y) Code, and M-Code) are given in Figure 0c.

GNSS System	GPS	GPS	GPS	GPS
Service Name	L2 CM	L2 CL	P(Y) Code	M-Code
Center Frequency	1227.60 MHz	1227.60 MHz	1227.60 MHz	1227.60 MHz
Frequency Band	L2	L2	L2	L2
Access Technique	CDMA	CDMA	CDMA	CDMA
Spreading Modulation	BPSK(1) result of multiplexing 2 streams at 511.5 kHz		BPSK (10)	BOC _{sin} (10,5)
Sub-carrier Frequency [MHz]	-	-	-	10.23
Code Frequency	511.5 kHz	511.5 kHz	10.23 MHz	5.115 MHz
Signal Component	Data	Pilot	Data	N/A
Primary PRN Code Length	10,230 (20 ms)	767,250 (1.5 seconds)	6.19×10^{12}	N/A
Code Family	M-sequence from a maximal polynomial of degree 27		Combo and short cycling of M-sequences	N/A
Secondary PRN Code Length	-	-	-	N/A
Data Rate	IIF 50 bps / 50 sps IIR-M Also 25 bps 50 sps with FEC	-	50 bps / 50 sps	N/A
Minimum Received Power [dBW]	II/IIA/IIR -164.5 dBW IIR-M -161.5 dBW IIF -161.5 dBW		II/IIA/IIR -164.5 dBW IIR-M -161.4 dBW IIF -160.0 dBW	N/A
Elevation	5°		5°	5°

Table 0a GPS L2 signal technical characteristics.

App C 003. The GPS L5 Band

The GPS L5 (1176.45 MHz) signal will be transmitted for the first time on board IIF satellites. The GPS carriers of the L5 band are modulated by two bit trains in phase quadrature: the L5 data channel and the L5 pilot channel. Moreover, two PRN ranging codes are transmitted on L5: the in-phase code (denoted as the I5-code) and the quadrature code (denoted as the Q5-code). The PRN L5-codes for SV number i are independent, but time synchronized ranging codes, $X_I^i(t)$ and $X_Q^i(t)$, of 1

millisecond in length at a chipping rate of 10.23 Mbps [GPS ICD-705]. For each code, the 1-millisecond sequences are the modulo-2 sum of two sub-sequences referred to as XA and XBi with lengths of 8,190 chips and 8,191 chips respectively, which restart to generate the 10,230 chip code. The XBi sequence is selectively delayed, thereby allowing the basic code generation technique to produce the different satellite codes.

See Figure 0b for the modulation scheme for the GPS L5 signals. See Figure 0e for the spectra of the GPS signals in L5. For more detail on L5, refer to (E.D. Kaplan and C. Hegarty, 2006). See Table 0b for the technical characteristics of the GPS signal in L5.

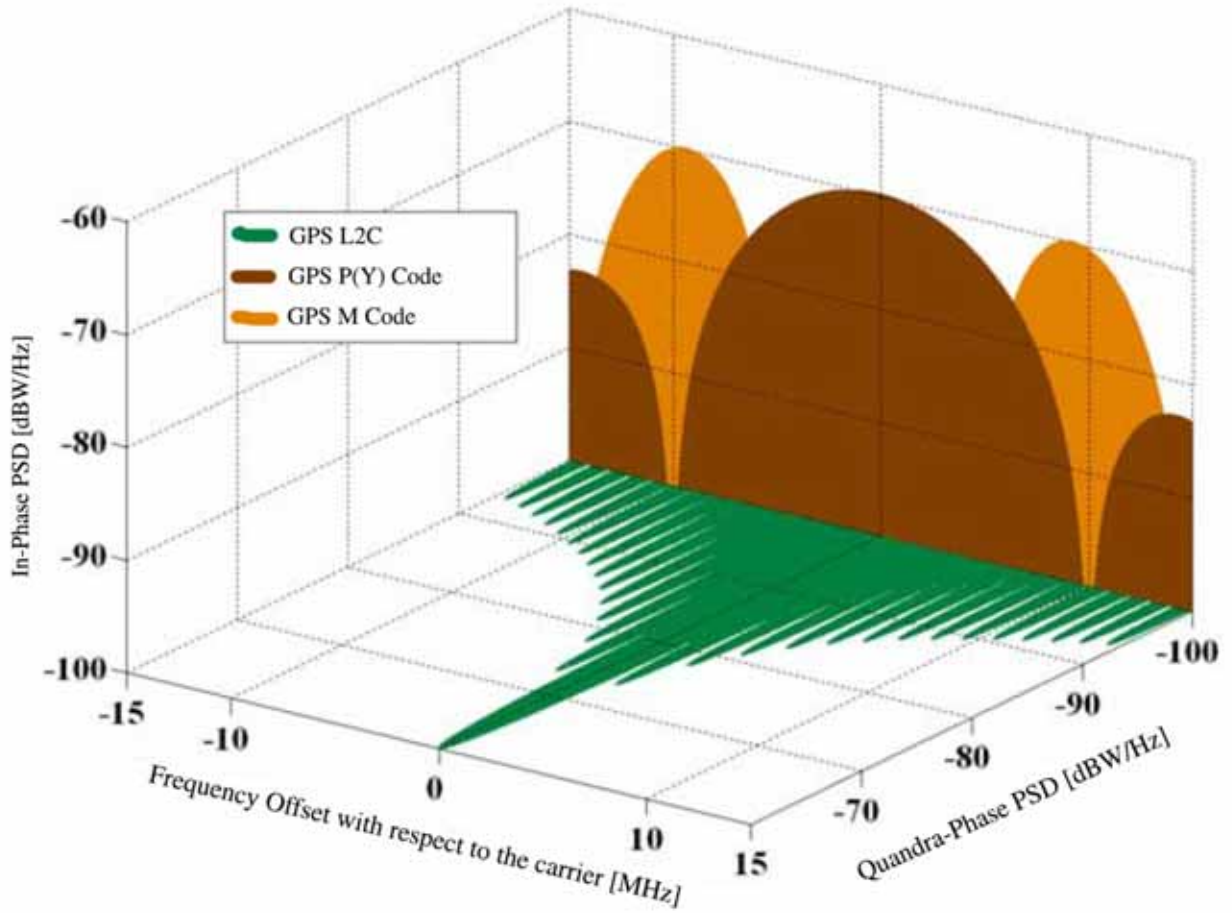

Figure 0c. Spectra of the GPS signals in L2. Image courtesy of Dr. Jose Angel Avila Rodriguez.

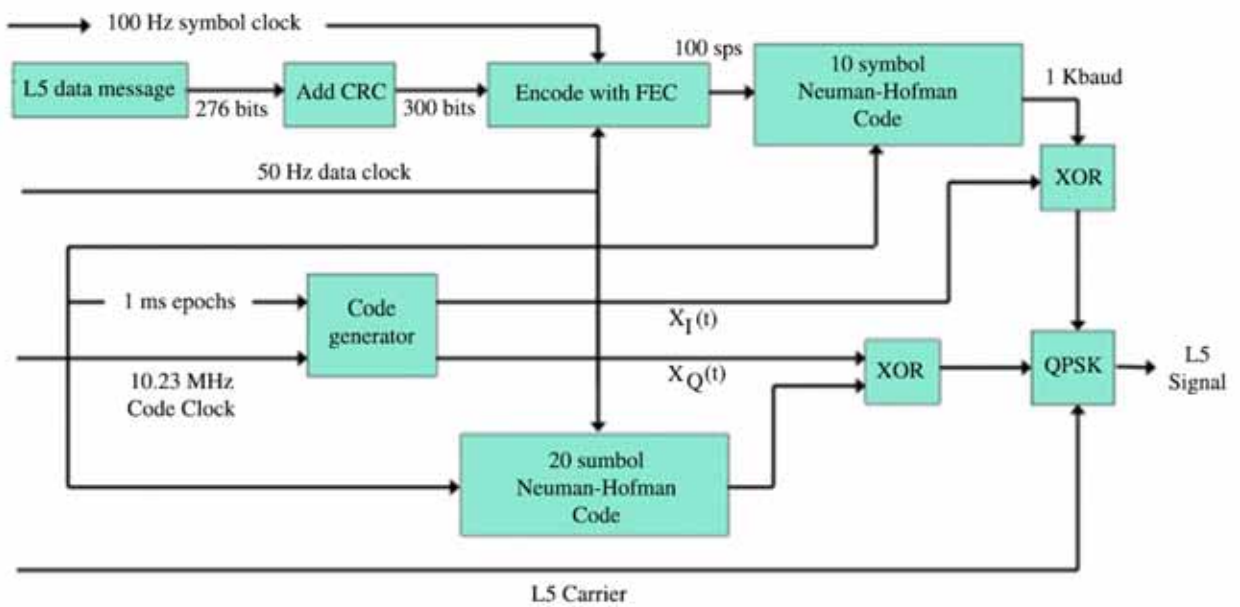

Figure 0d. Modulation scheme for the GPS L5 signals. Image courtesy of Dr. Jose Angel Avila Rodriguez.

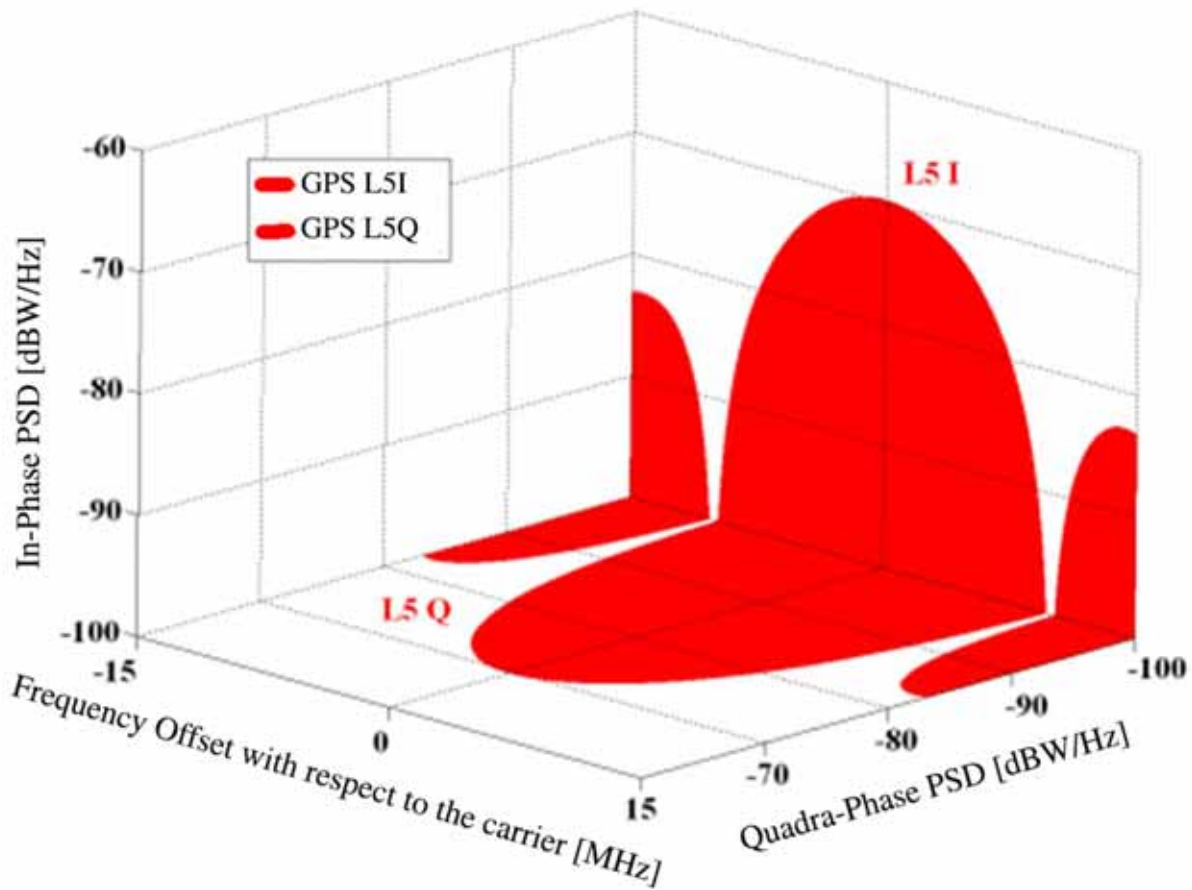

Figure 0e. Spectra of the GPS signals in L5. Image courtesy of Dr. Jose Angel Avila Rodriguez.

GNSS System	GPS	GPS
Service Name	L5I	L5Q
Center Frequency	1176.45 MHz	1176.45 MHz
Frequency Band	L5	L5
Access Technique	CDMA	CDMA
Spreading modulation	BPSK(10)	BPSK(10)
Sub-carrier Frequency	-	-
Code Frequency	10.23 MHz	10.23 MHz
Signal Component	Data	Pilot
Primary PRN Code Length	10230	10230
Code Family	Combination and short-cycling of M-sequences	
Secondary PRN Code Length	10	20

Table 0b GPS L5 signal technical characteristics.

GNSS System	GPS	GPS
Data Rate	50 bps/ 100sps	-
Minimum Received Power [dBW]	-157.9 dBW	-157.9 dBW
Elevation	5°	5°

Table 0b GPS L5 signal technical characteristics.

THE GALILEO SIGNAL PLAN

App C 004. Galileo E1 Open Service Band

The E1 Open Service (OS) modulation receives the name of CBOC (Composite Binary Offset Carrier) and is a particular implementation of MBOC (Multiplexed BOC) [J.-A. Avila-Rodriguez et al., 2007]. MBOC(6,1,1/11) is the result of multiplexing a wide band signal - BOC(6,1) - with a narrow band signal - BOC(1,1) - in such a way that 1/11 of the power is allocated, in average, to the high frequency component. This signal was the last one to be defined.

The normalized (unit power) power spectral density, specified without the effect of band-limiting filters and payload imperfections, is given by

$$G_{MBOC(6,1,1/11)}(f) = \frac{10}{11}G_{BOC(1,1)}(f) + \frac{1}{11}G_{BOC(6,1)}(f) .$$

As in [Galileo SIS ICD, 2010], the generic view of the E1 Open Service signal generation can be depicted as follows [J.-A. Avila-Rodriguez et al., 2007] in Figure 0f - Modulation Scheme for Galileo E1 OS Signals:

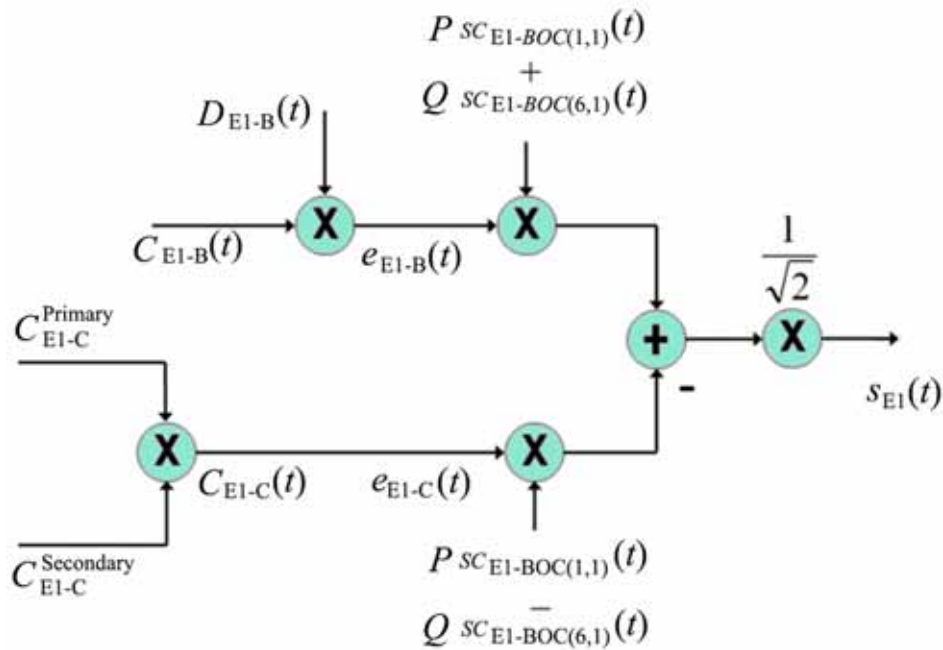

Figure 0f. Modulation scheme for Galileo E1 OS signals. Image courtesy of Dr. Jose Angel Avila Rodriguez.

The whole transmitted Galileo E1 signal consists of the multiplexing of the three following components:

- The E1 Open Service Data channel $e_{E1-B}(t)$ is generated from the I/NAV navigation data stream $D_{E1-B}(t)$ and the ranging code $C_{E1-B}(t)$, which are then modulated with the sub-carriers

$SC_{E1-BOC(1,1)}(t)$ and $SC_{E1-BOC(6,1)}(t)$ of BOC(1,1) and BOC(6,1) respectively.

- The E1 Open Service Pilot channel $e_{E1-C}(t)$ is generated from the ranging code $C_{E1-C}(t)$, including its secondary code, which is then modulated with the sub-carriers $SC_{E1-BOC(1,1)}(t)$

and $SC_{E1-BOC(6,1)}(t)$ in anti-phase.

- The E1 PRS channel, also denoted as E1-A, which results from the modulo-two addition (respectively product if we consider the physical bipolar representation of the signal) of the PRS data stream $D_{PRS}(t)$,

the PRS sequence $C_{PRS}(t)$ and the sub-carriers $SC_{PRS}(t)$. This sub-carrier consists of a BOC(15,2.5) in cosine phasing.

Figure 0h

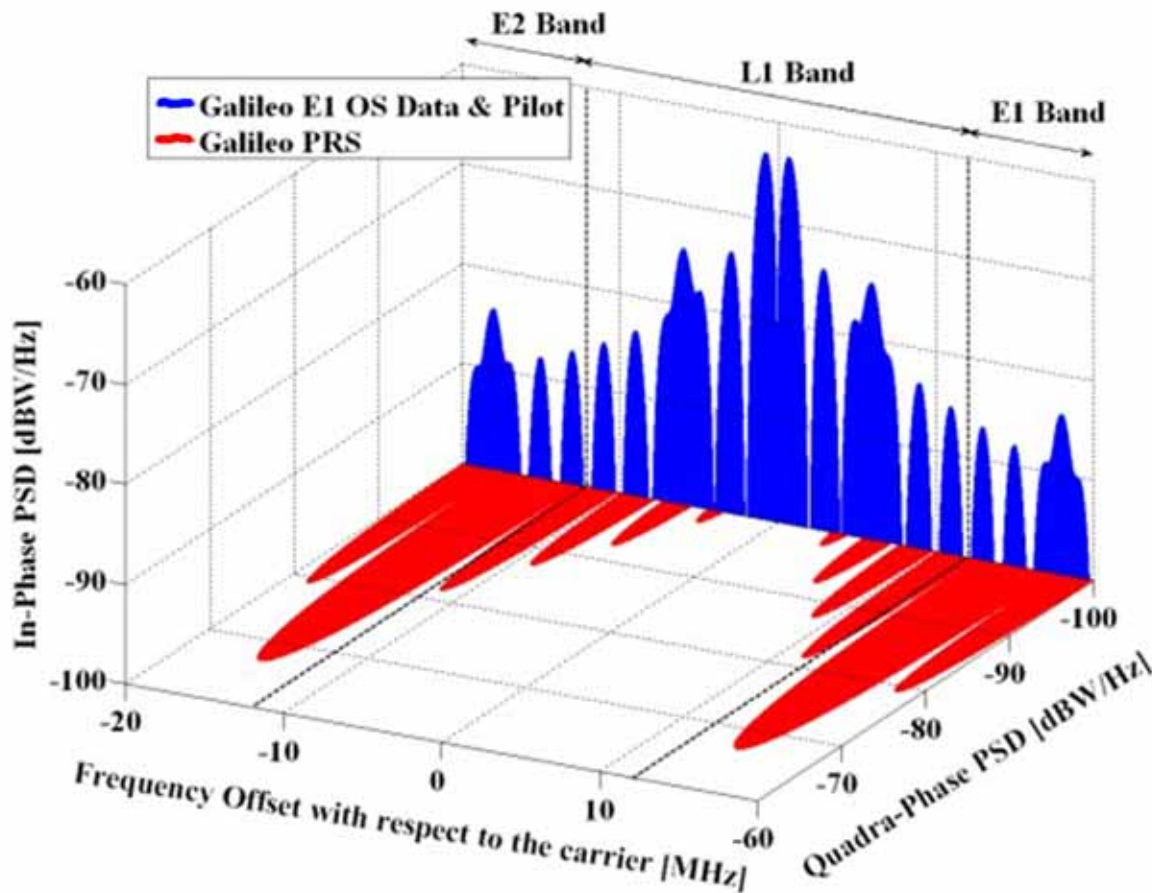

Figure 0g. Spectra of Galileo signals in E1. Image courtesy of Dr. Jose Angel Avila Rodriguez.

See for the Spectra of Galileo Signals in E1 and for the Spectra of both GPS and Galileo Signals in L1.

It is important to recall that for a long time the actual E1 band received the name of L1 band in analogy with GPS and it was not until the publication of the [Galileo SIS ICD, 2008] that L1 changed to the current E1.

The E1 Open Service (OS) codes are, as well as the E6 CS codes that we will see later, also random memory codes. The plain number of choices to set the 0's and 1's for the whole code family is enormous and thus special algorithms have to be applied to generate random codes efficiently [J.-A. Avila-Rodriguez et al., 2007].

Finally, the technical characteristics of all the Galileo signals in E1 are summarized in Table 0c.

App C 005. Galileo E6 Band

As shown in [Galileo SIS ICD, 2010], the transmitted Galileo E6 signal consists of the following three components:

- The E6 Commercial Service (CS) data channel: this modulating signal is the modulo-two addition of the E6 CS navigation data stream $D_{CS}(t)$ with the CS data channel code sequence $D_{CS}^D(t)$. This last one is already modulated by a BPSK(5) at 5.115 MHz.
- The E6 Commercial Service (CS) pilot channel: this modulating signal is the modulo-two addition of the E6 CS pilot channel code $C_{CS}^P(t)$ with a BPSK(5) at 5.115 MHz.
- Finally, the E6 PRS channel is the modulo-two

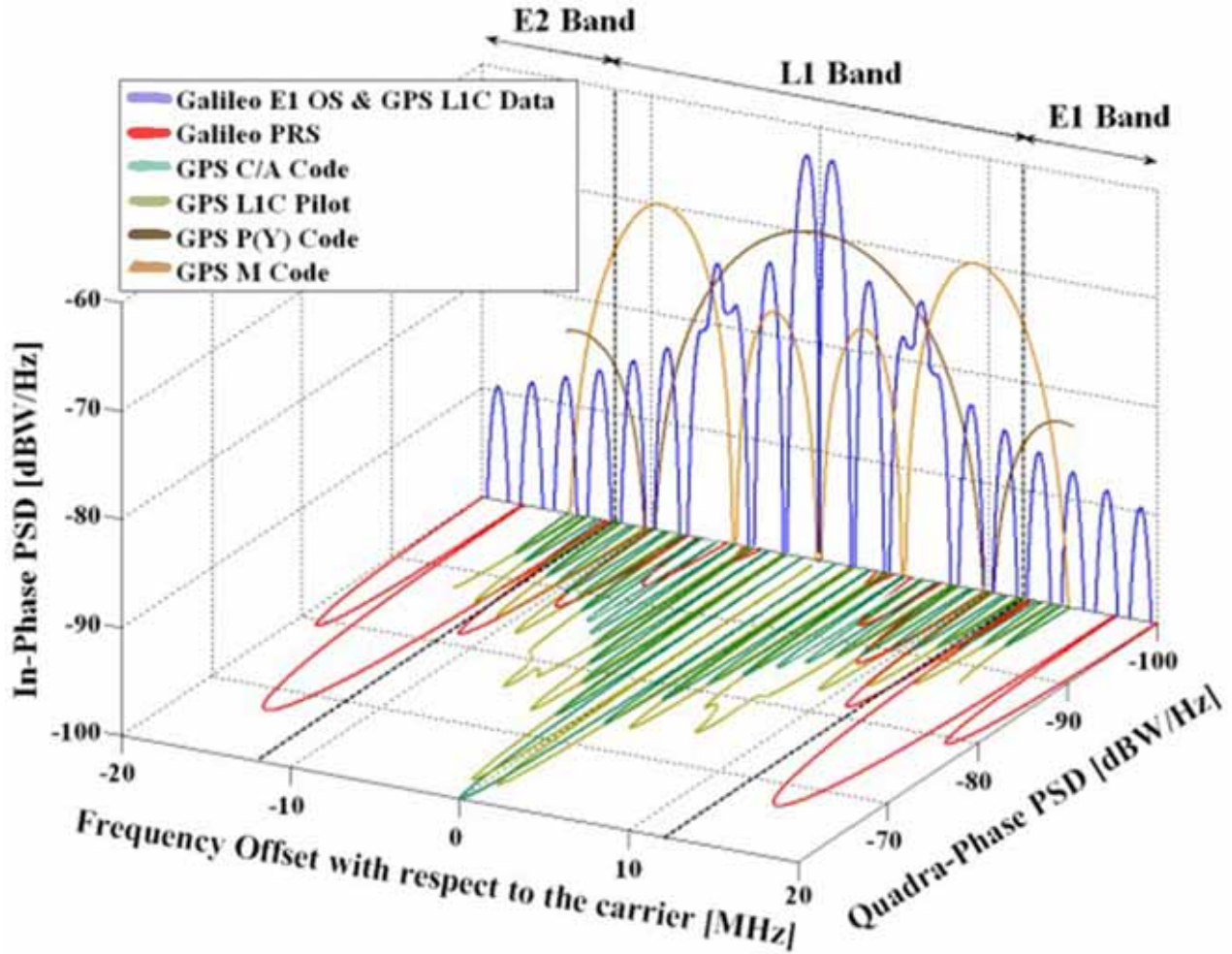

Figure 0h. Spectra of GPS and Galileo signals in L1. Image courtesy of Dr. Jose Angel Avila Rodriguez.

GNSS System	Galileo	Galileo	Galileo
Service Name	E1 OS		PRS
Center Frequency	1575.42 MHz		
Frequency Band	E1		
Access Technique	CDMA		
Spreading modulation	CBOC(6,1,1/11)		BOC _{cos} (15,2,5)
Sub-carrier Frequency	1.023 MHz and 6.138 MHz (two sub-carriers)		15.345 MHz
Code Frequency	1.023 MHz		2.5575 MHz
Signal Component	Data	Pilot	Data
Primary PRN Code Length	4092		N/A
Code Family	Random Codes		N/A

Table 0c. Galileo E1 signal technical characteristics.

GNSS System	Galileo	Galileo	Galileo
Secondary PRN Code Length	-	25	N/A
Data Rate	250 sps	-	N/A
Minimum Received Power [dBW]	-157 dBW		N/A
Elevation	10°		N/A

Table 0c. Galileo E1 signal technical characteristics.

addition of the E6 PRS navigation data stream $D_{PRS}(t)$ with the PRS channel code sequence $C_{PRS}(t)$ at 5.115 MHz. This signal is further modulated by a sub-carrier of 10.23 MHz in cosine phasing.

This is graphically shown in Figure 0i - *Modulation Scheme for the Galileo E6 Signals* and Figure 0j - *Spectra of Galileo signals in E6*. Table 0d provides the technical characteristics of the Galileo E6 signal.

The E6 Commercial Service (CS) codes are random

codes [J. Winkel, 2006]. The main idea behind is to generate a family of codes that fulfills the properties of randomness as well as possible [J.-A. Avila-Rodriguez et al., 2007]. The codes can be driven to fulfill special properties such as balance and weakened balance, where the probability of 0's and 1's must not be identical but within a well-defined range, or to realize the autocorrelation side-lobe zero (ASZ) property. This latter property guarantees that the autocorrelation values of every code correlate to zero with a delayed version of itself, shifted by one chip.

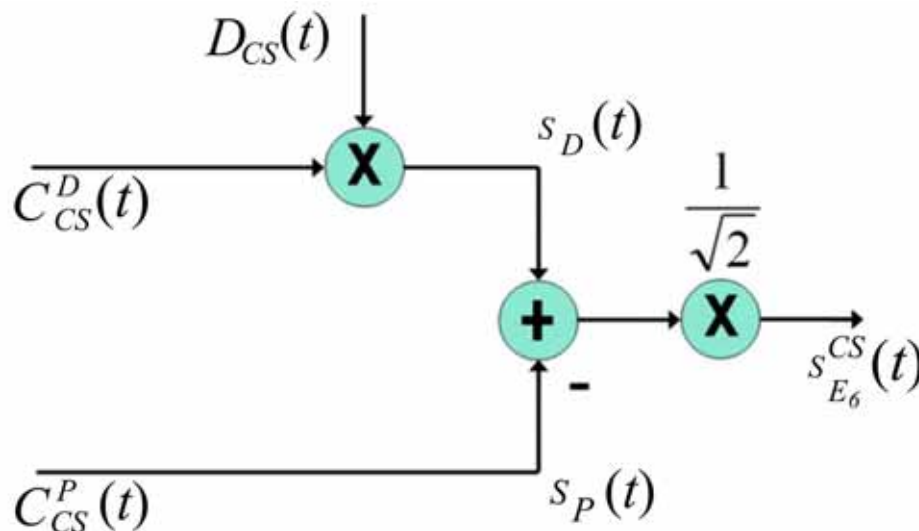

Figure 0i. Modulation scheme for Galileo E6 signals. Image courtesy of Dr. Jose Angel Avila Rodriguez.

App C 006. Galileo E5 Band

The different Galileo E5 signal components are generated according to the following [Galileo SIS ICD, 2010]:

- The **E5a data channel**: This channel is the modulo-two addition of the E5a navigation data stream $D_{E5a}(t)$ with the E5a data channel PRN code sequence $C_{E5a}^D(t)$ of chipping rate 10.23 MHz.

- The **E5a pilot channel**: This channel is the E5a pilot channel PRN code sequence $C_{E5a}^P(t)$ of chipping rate 10.23 MHz.
- The **E5b data channel**: This channel is the modulo-two addition of the E5b navigation data stream $D_{E5b}(t)$ with the PRS channel code sequence $C_{PRS}(t)$ with the E5b data channel PRN code

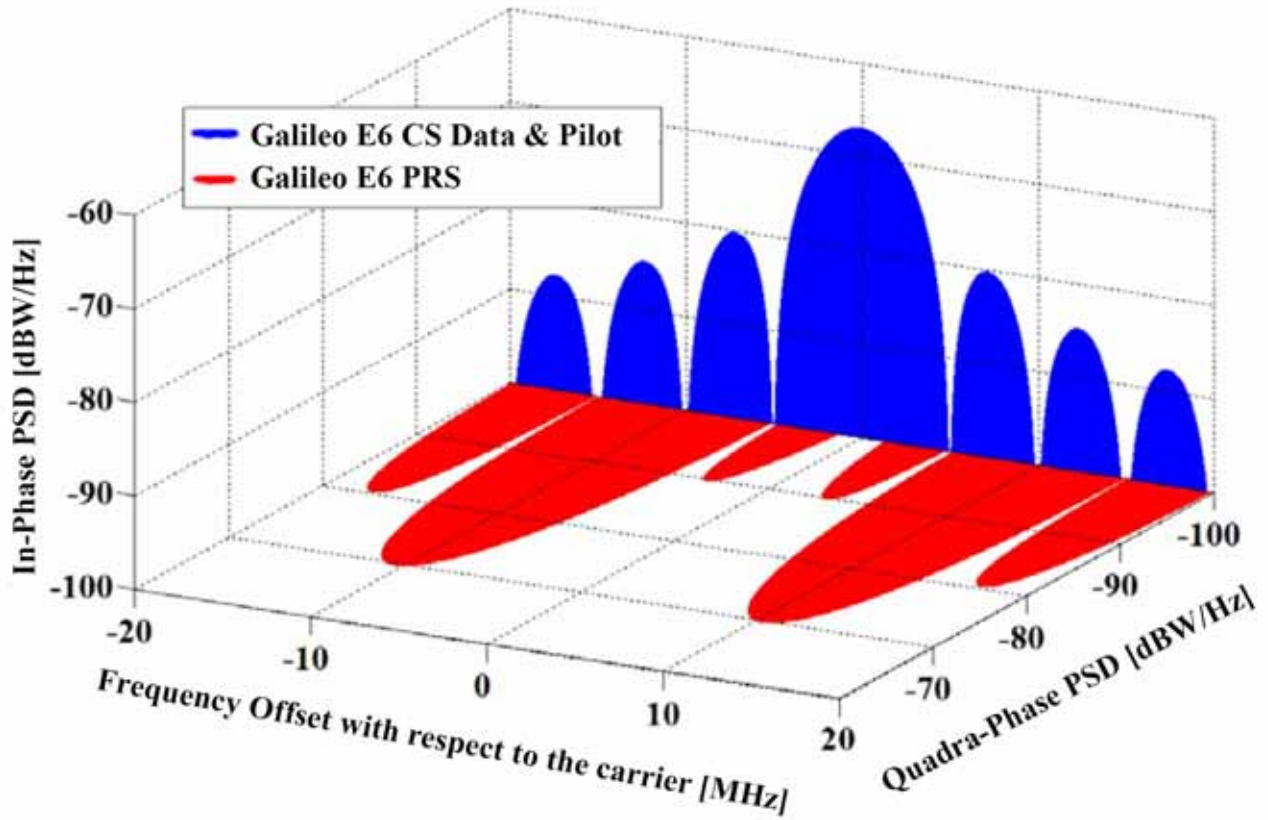

Figure 0j. Modulation scheme for Galileo E6 signals. Image courtesy of Dr. Jose Angel Avila Rodriguez.

GNSS System	Galileo	Galileo	Galileo
Service Name	E6 CS data	E6 CS pilot	E6 PRS
Center Frequency	1278.75 MHz		
Frequency Band	E6		
Access Technique	CDMA		
Spreading modulation	BPSK(5)	BPSK(5)	BOC _{cos} (10.5)
Sub-carrier Frequency	-	-	10.23 MHz
Code Frequency	5.115 MHz		
Signal Component	Data	Pilot	Data
Primary PRN Code Length	5115	5115	N/A
Code Family	Memory codes		N/A
Secondary PRN Code Length	-	100	N/A
Data Rate	1000 sps	-	N/A
Minimum Received Power [dBW]	-155 dBW		N/A

Table 0d. Galileo E6 signal technical characteristics.

GNSS System	Galileo	Galileo	Galileo
Elevation	10°		N/A

Table 0d. Galileo E6 signal technical characteristics.

sequence $C_{E5b}^D(t)$ of chipping rate 10.23 MHz.

- The **E5b pilot channel**: This channel is the E5b pilot channel PRN code sequence $C_{E5b}^P(t)$ of chipping rate 10.23 MHz.

The E5 modulation receives the name of AltBOC and is a modified version of a Binary Offset Carrier (BOC) with code rate of 10.23 MHz and a sub-carrier frequency of 15.345 MHz. AltBOC(15,10) is a wideband signal that is transmitted at 1191.795 MHz. Figure 0k shows the Galileo E5 signal modulation diagram.

The power spectral density for the modified AltBOC(15,10) modulation with constant envelope is shown to adopt the form:

$$G_{\text{AltBOC}}(f) = \frac{4f_c}{\pi^2 f^2 \cos^2\left(\frac{\pi f}{2f_z}\right)} \left[\cos^2\left(\frac{\pi f}{2f_z}\right) - \cos\left(\frac{\pi f}{2f_z}\right) - 2 \cos\left(\frac{\pi f}{2f_z}\right) \cos\left(\frac{\pi f}{4f_z}\right) \right]$$

The spectrum of the E5 signal modulation is shown in Figure 0l.

As we can recognize from both figures, the AltBOC(15,10) modulation is very similar to two BPSK(10) signals shifted by 15 MHz to the left and right of the carrier frequency. Indeed, since to acquire all the main lobes of the modulation a very wide bandwidth is necessary, many receivers will operate correlating the AltBOC signal with a BPSK(10) replica.

To have a better feeling about the overlapping between GPS and Galileo in E5, Figure 0m shows all the signals described so far for this band.

The E5 primary codes can be generated with shift registers. Indeed, the outputs of two parallel registers are modulo-two added to generate the primary codes. For more details on the start values of the primary codes and the corresponding secondary codes of each satellite, refer to [Galileo SIS ICD, 2010]. Finally, some details on the technical characteristics of the E5 signal are presented in Table 0e.

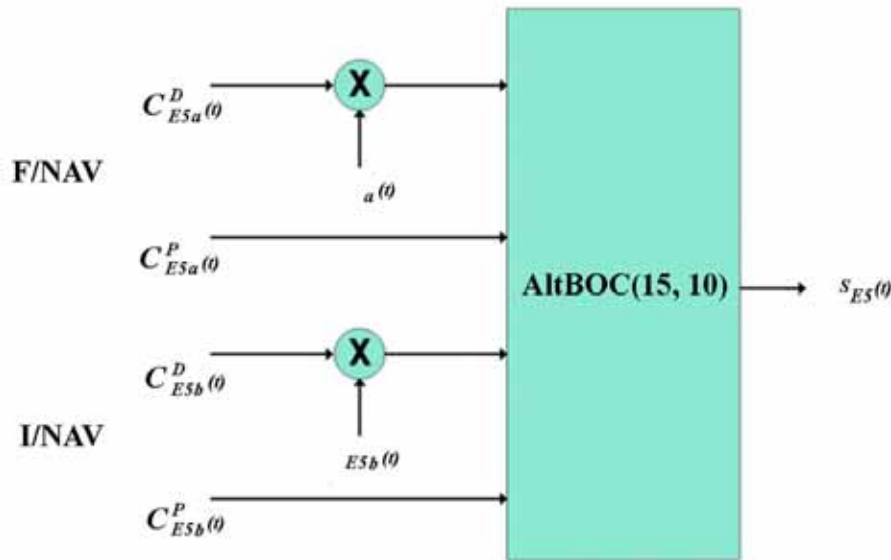

Figure 0k. Modulation scheme for Galileo E5 signals. Image courtesy of Dr. Jose Angel Avila Rodriguez.

THE GLONASS SIGNAL PLAN

App C 007. GLONASS Signal Coding

GLONASS, unlike the other GNSS systems, makes use of a different DSSS technique [G.W. Hein et al., 2006c]

based on Frequency Division Multiple Access (FDMA) to transmit its ranging signals..

GLONASS uses FDMA in both the L1 and L2 sub-bands. According to this scheme, each satellite transmits

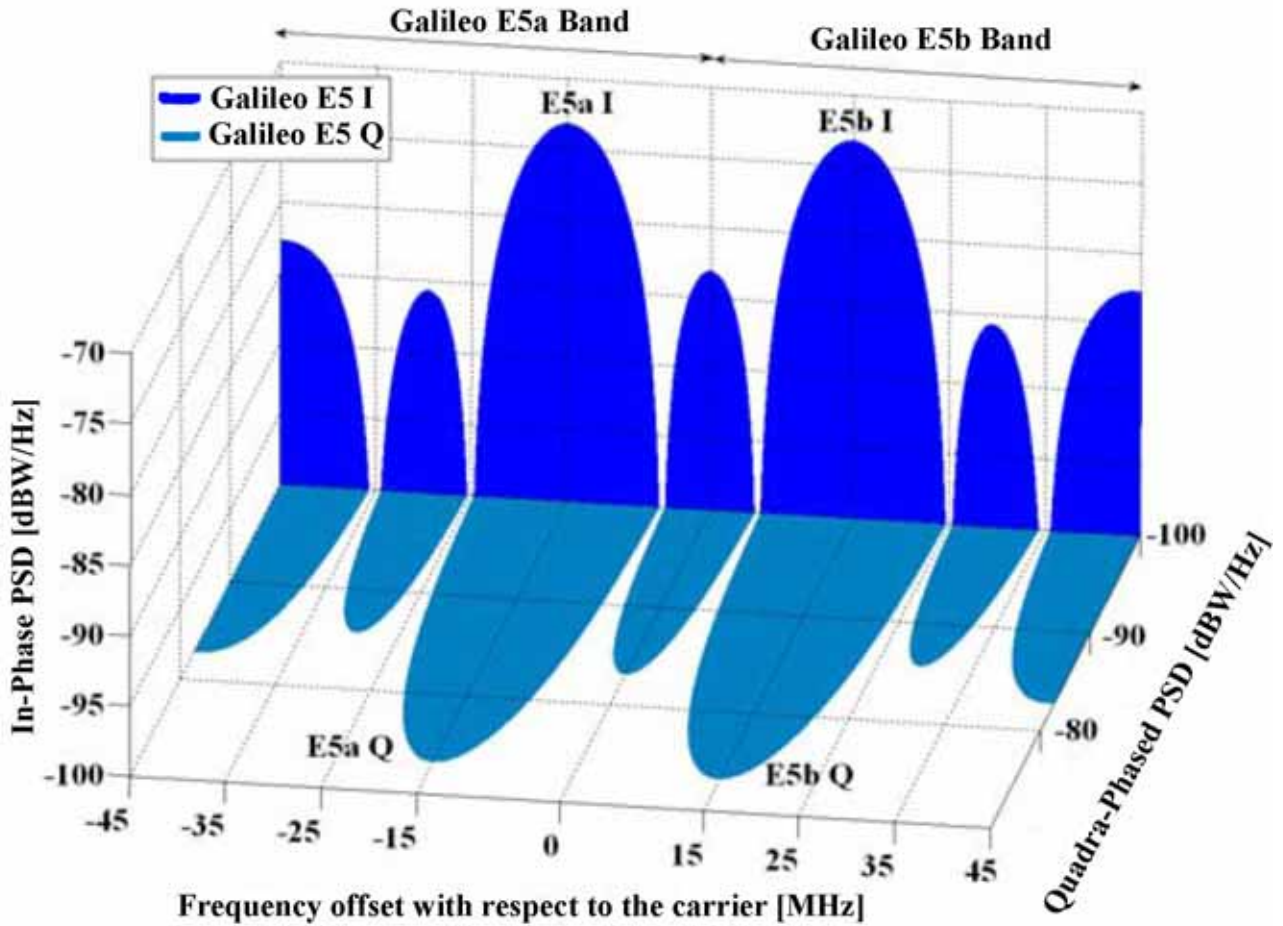

Figure 0l. Spectra of Galileo signals in E5. Image courtesy of Dr. Jose Angel Avila Rodriguez.

navigation signals on its own carrier frequency, so that two GLONASS satellites may transmit navigation signals on the same carrier frequency if they are located in antipodal slots of a single orbital plane [GLONASS ICD, 2002]. Indeed the actual constellation is taking advantage of this property since 2005 when the higher frequency channels had to be turned off to fulfill the CCIR Recommendation 769. We can clearly see this if we have a look at the satellites assigned to each of the GLONASS planes as shown in the following figure with status as of May 2008. As is clear to see, antipodal satellites are transmitting at the same frequency.

See Figure 0n for a depiction of the three GLONASS orbital planes. The red slots indicate that the satellite is in maintenance. Blue means correct operation. Moreover, two different types of signals [GLONASS ICD, 2002] are transmitted by GLONASS satellites: Standard Precision (SP) and High Precision (HP) in both the L1 and L2 bands. The GLONASS standard accuracy signal, also known as C/A Code, has a clock rate of 0.511 MHz and is designed for use by civil users worldwide while the high accuracy signal (P Code) has a clock rate of 5.11 MHz and is modulated by a special code which is only available to users authorized by

the Ministry of Defense. Since GLONASS-M, both L1 and L2 provide users with the standard accuracy code C/A. Moreover, the modernized GLONASS will also transmit FDMA signals on the L3 band and CDMA signals in L1 and L5.

The nominal values of the FDMA L1, L2 and L3 carrier frequencies are defined as:

$$\begin{aligned}
 f_{kL1} &= f_{0L1} + k\Delta f_{L1} \\
 f_{kL2} &= f_{0L2} + k\Delta f_{L2} \quad (1) \\
 f_{kL3} &= f_{0L3} + k\Delta f_{L3}
 \end{aligned}$$

where:

- k represents the frequency channel,
- $f_{0L1} = 1602$ MHz for the GLONASS L1 band,
- $\Delta f_{L1} = 562.5$ kHz frequency separation between GLONASS carriers in the L1 band,
- $f_{0L2} = 1246$ MHz for the GLONASS L2 band,
- $\Delta f_{L2} = 437.5$ kHz frequency separation between

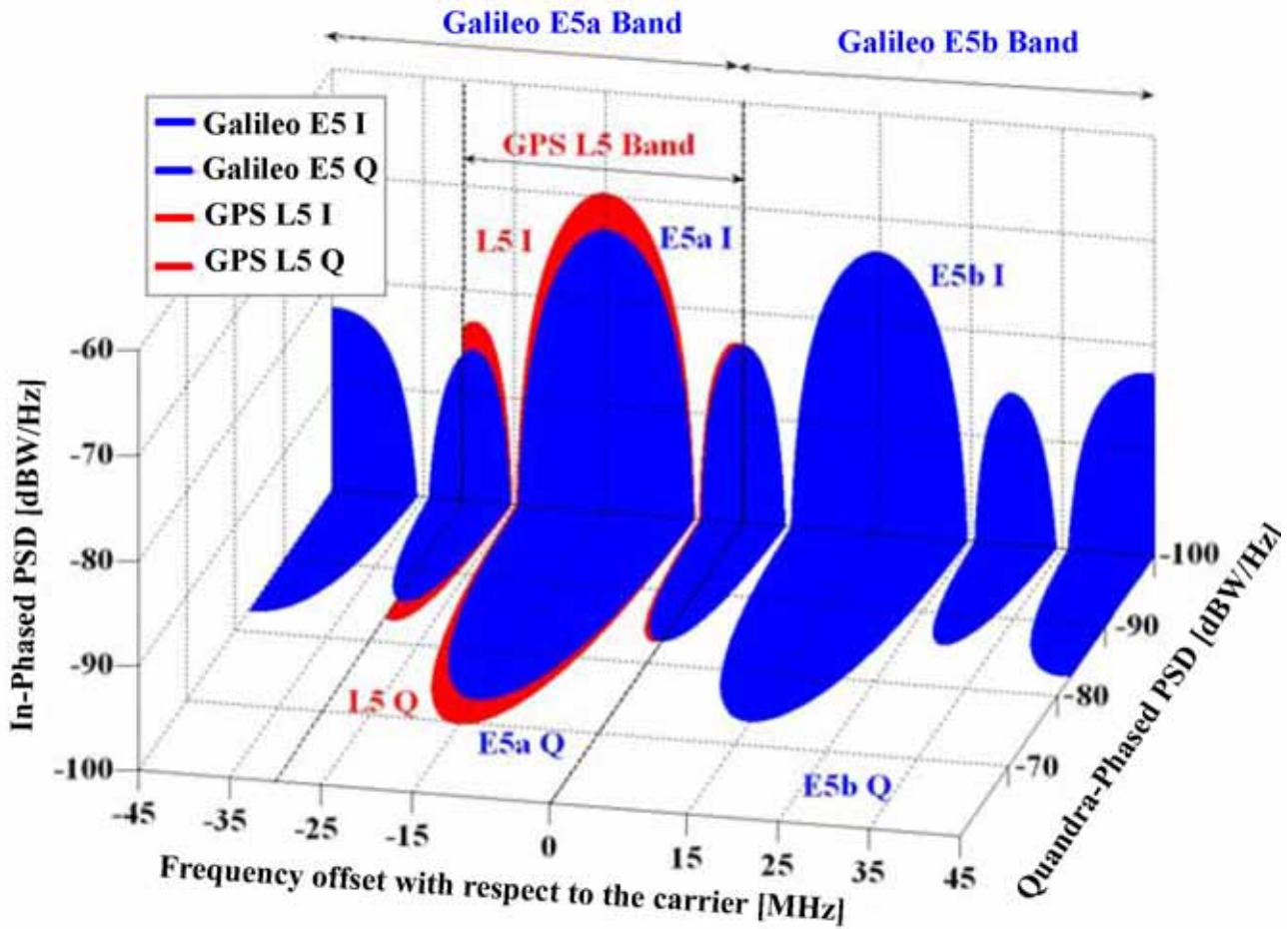

Figure 0m. Spectra of GPS and Galileo Signals in E5. Image courtesy of Dr. Jose Angel Avila Rodriguez.

GNSS System	Galileo	Galileo	Galileo	Galileo
Service Name	E5a data	E5a pilot	E5a data	E5b pilot
Center Frequency	1191.795 MHz			
Frequency Band	E5			
Access Technique	CDMA			
Spreading modulation	AltBOC(15, 10)			
Sub-carrier Frequency	15.345 MHz			
Code Frequency	10.23MHz			
Signal Component	Data	Pilot	Data	Pilot
Primary PRN Code Length	10230			
Code Family	Combination and short-cycling of M-sequences			
Secondary PRN Code Length	20	100	4	100

Table 0e. Galileo E5 signal technical characteristics.

GNSS System	Galileo	Galileo	Galileo	Galileo
Data Rate	50 sps	-	250 sps	-
Minimum Received Power [dBW]	-155 dBW		-155 dBW	
Elevation	10°		10°	

Table 0e. Galileo E5 signal technical characteristics.

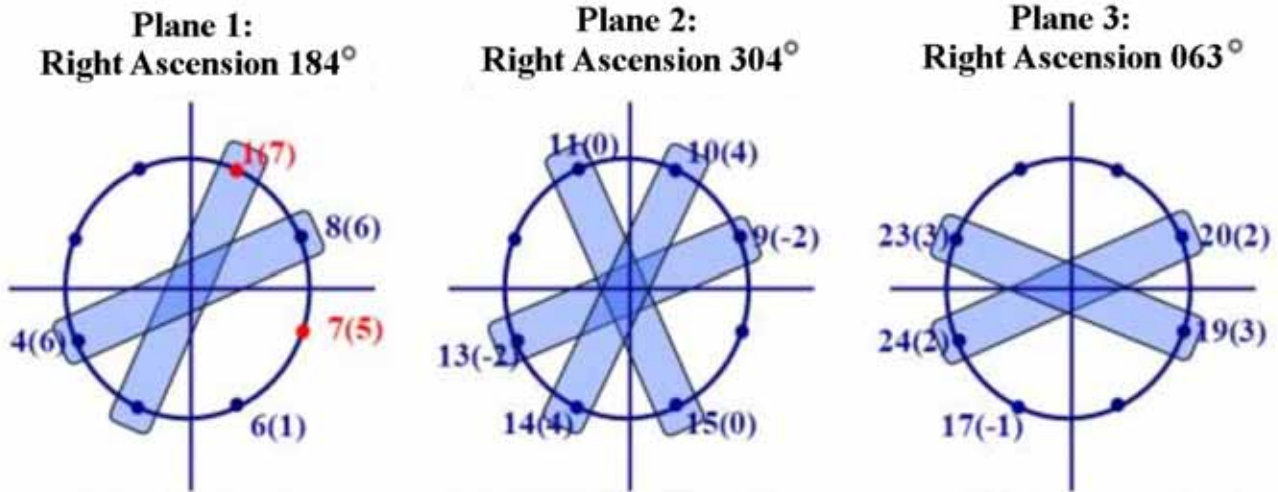

Figure 0n. Antipodal assignment of GLONASS satellites. The parameter $i(k)$ indicates that the satellite in almanac slot i transmits on frequency number k . Image courtesy of Dr. Jose Angel Avila Rodriguez.

GLONASS carriers in the L2 band,

$$f_{0L3} = 1201 \text{ MHz for the GLONASS L3 band, and}$$

$$\Delta f_{L3} = 437.5 \text{ kHz frequency separation between}$$

GLONASS carriers in the L3 band.

As we can see, the GLONASS L2 carrier reference signal is 7/9 of the L1 carrier reference and the GLONASS L3 carrier reference is 3/4 of the L1 carrier reference. Moreover, it must be noted that until 2005 the GLONASS satellites used the frequency channels $k = 0, \dots, 12$ without any restrictions and the channel numbers $k = 0$ and 13 for technical purposes.

Since then GLONASS is only using the frequency channels $k = -7, \dots, +6$ and all the satellites launched beyond that year will use filters, limiting out-of-band emissions to the harmful interference limit contained in CCIR-ITU Recommendation 769 for the 1610.6 - 1613.8 MHz and 1660 - 1670 MHz Radio-Astronomy bands. It is interesting to note that although the limitation to use the higher frequency channels does only affect the L1 band, since the parameter k determines the channel in both the L1 and L2 bands, the upper frequencies of L2 corresponding to channels $+7$ to $+13$ were automatically sacrificed.

To have a clearer insight into how the spectra of the GLONASS signals look like, we study next all the bands in

detail.

App C 008. GLONASS L1 Band and Signal Structure

The transmitted navigation signal is in both services of L1 a bipolar phase-shift key (BPSK) waveform with clock rates of 0.511 and 5.11 MHz for the standard and accuracy signals respectively. The L1 signal is modulated by the Modulo-2 addition of the pseudo random (PR) ranging code, the digital data of the navigation message and an auxiliary meander sequence. All above-mentioned frequencies are generated coherently using a single onboard time/frequency oscillator standard [GLONASS ICD, 2002]. For the case of the standard accuracy signals (C/A), the PR ranging code is a sequence with length the maximum of a shift register (m-sequence) and a period of 1 millisecond with bit rate of 511 kbps. The navigation message is sent at 50 bps and the auxiliary meander sequence at 100 Hz.

Moreover, it is important to note that the GLONASS FDMA L1 band does not exactly coincide with the GPS and Galileo L1 band. In fact, the GLONASS L1 band ranges from 1592.9525 MHz to 1610.485 MHz when only the 14 channels $k = -7 \dots +6$ are employed. In the next figures, each of the channels was filtered to only transmit the main lobe

of the BPSK signal and the PSD was normalized to have unit power within the corresponding transmission bandwidth.

The PSDs of the GLONASS signals are shown in Figure 0o:

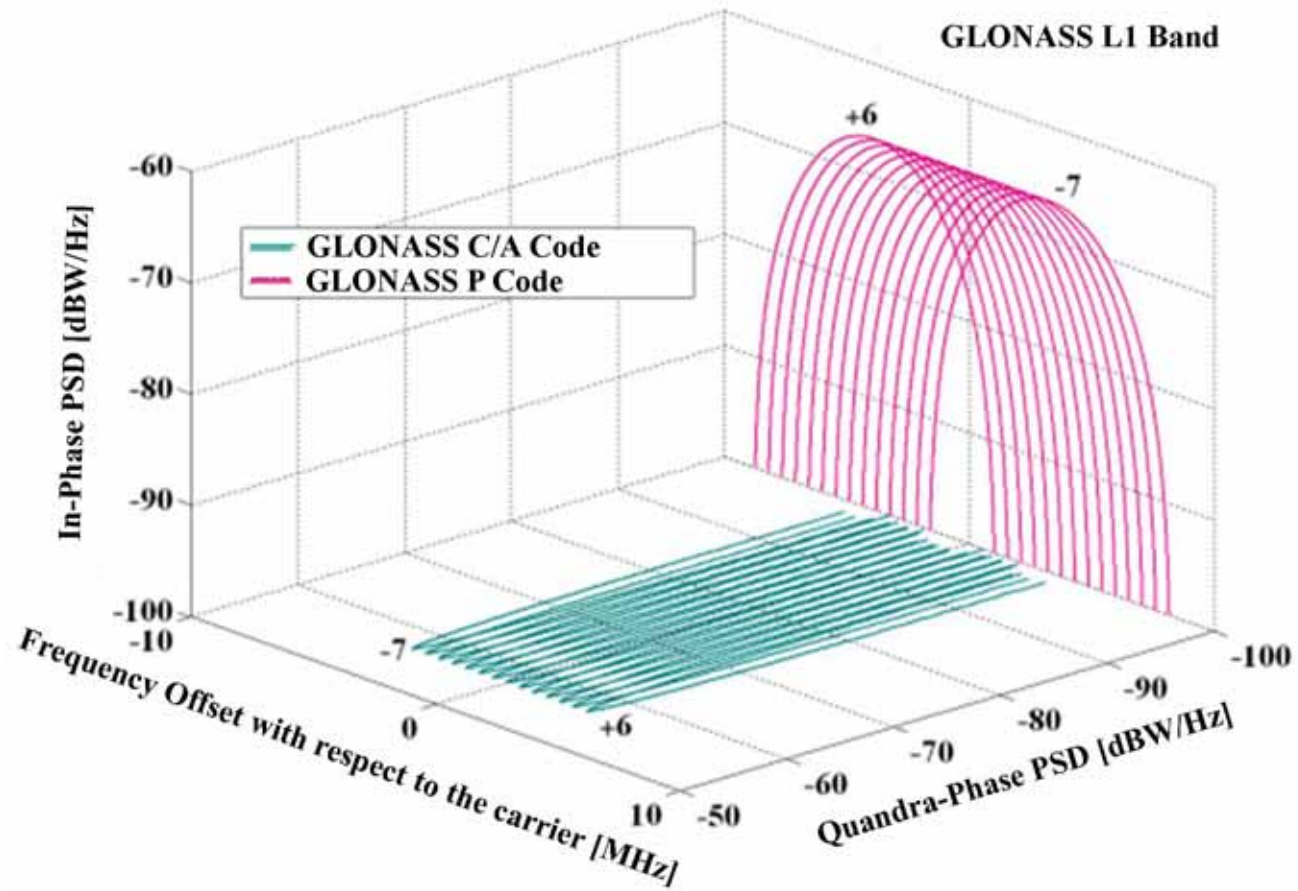

Figure 0o. Spectra of GLONASS signals in L1. Image courtesy of Dr. Jose Angel Avila Rodriguez.

Once again, in order to have a clearer picture of how overcrowded the RNSS bands are becoming as more and more countries claim their rights to have their own GNSS, Figure 0p shows GPS, Galileo and GLONASS signals in the E1/L1 band.

It is important to note that the GPS L1C pilot and data signals are shown in quadrature in Figure 0p although according to [GPS ICD-800, 2006] the final phasing is still open. To finalize some details on the technical characteristics of the GLONASS L1 signals are presented Table 0f:

It is important to note that unlike for the case of GPS and Galileo, the frequencies do not have to be multiplied by the factor 1.023.

App C 009. GLONASS L2 Band and Signal Structure

The transmitted navigation signal is, as also in L1, a bipolar phase-shift key (BPSK) waveform with similar clock rates as in the L1 band. The L2 signal is modulated by the Modulo-2 addition of the PR ranging code and the auxiliary meander sequence. For the case of the standard accuracy

signals (C/A), the PR ranging code is a sequence of the maximum length of a shift register (M-sequence) with a period of 1 millisecond and a bit rate of 511 kbps. The navigation message is sent at 50 bps and the auxiliary meander at 100 Hz.

Figure 0q shows the spectra of the GLONASS signals in L2 and Figure 0r shows spectra of both the GLONASS and GPS signals in L2.

Details on the technical characteristics of the GLONASS L2 signals are presented in Table 0g.

It is important to note again that unlike for the case of GPS and Galileo in the previous chapters, the frequencies do not have to be multiplied by the factor 1.023.

App C 010. References

Ávila Rodríguez, José Ángel. (2008). *On Generalized Signal Waveforms for Satellite Navigation*. University FAF, Munich. Retrieved from: <https://athene-forschung-unibw.de/doc/86167/86167.pdf>. Sections reproduced with permission.

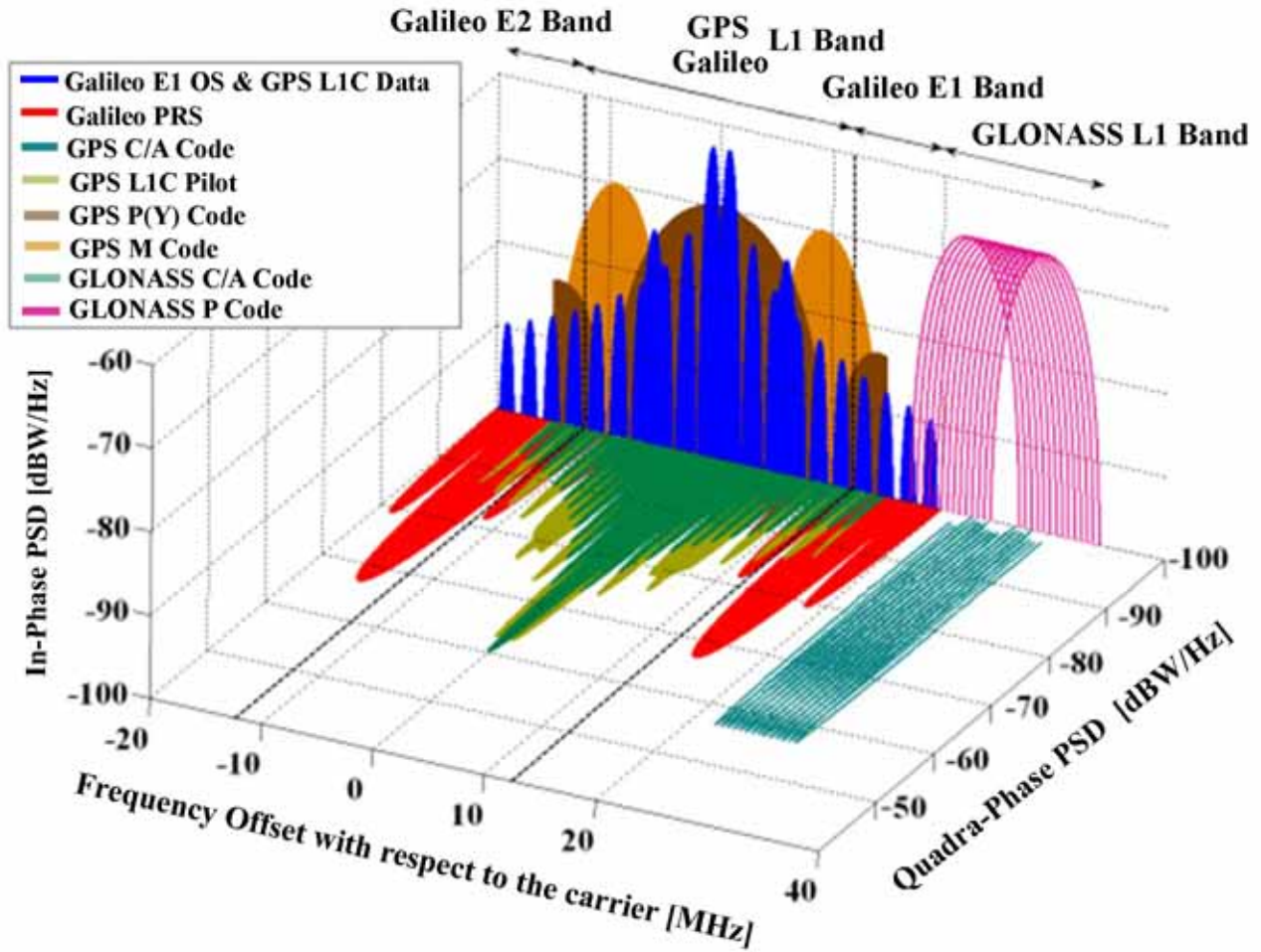

Figure 0p. Spectra of GPS, Galileo and GLONASS signals in E1/L1. Image courtesy of Dr. Jose Angel Avila Rodriguez.

GNSS System	GLONASS	GLONASS
Service Name	C/A Code	P Code
Center Frequency	(1598.0625-1605.375) MHz [+ or -] 0.511 MHz	
Frequency Band	L1	L1
Access Technique	FDMA	FDMA
Spreading modulation	BPSK(0.511)	BPSK(5.11)
Sub-carrier Frequency	-	-
Code Frequency	0.511 MHz	5.11 MHz
Signal Component	Data	Pilot
Primary PRN Code Length	511	N/A
Code Family	M-sequences	N/A
Meander sequence	100 Hz	N/A

Table Of GLONASS L1 signal technical characteristics.

GNSS System	GLONASS	GLONASS
Data Rate	50 bps	N/A
Minimum Received Power [dBW]	-161 dBW	N/A
Elevation	5°	N/A

Table Of GLONASS L1 signal technical characteristics.

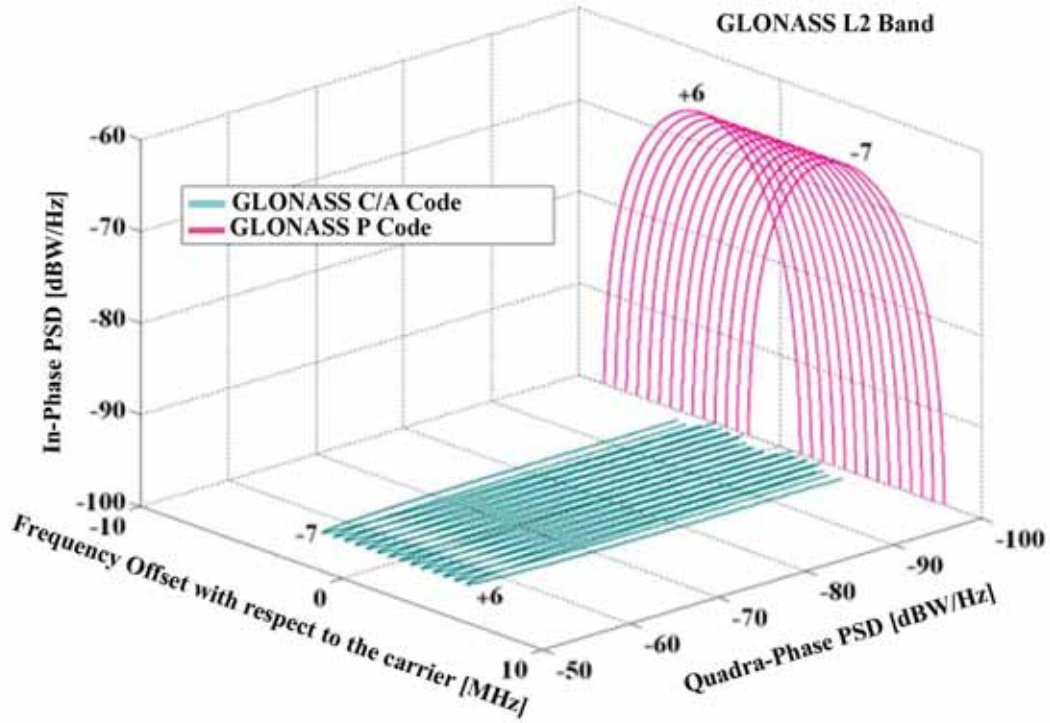

Figure 0q. Spectra of GLONASS signals in L2. Image courtesy of Dr. Jose Angel Avila Rodriguez.

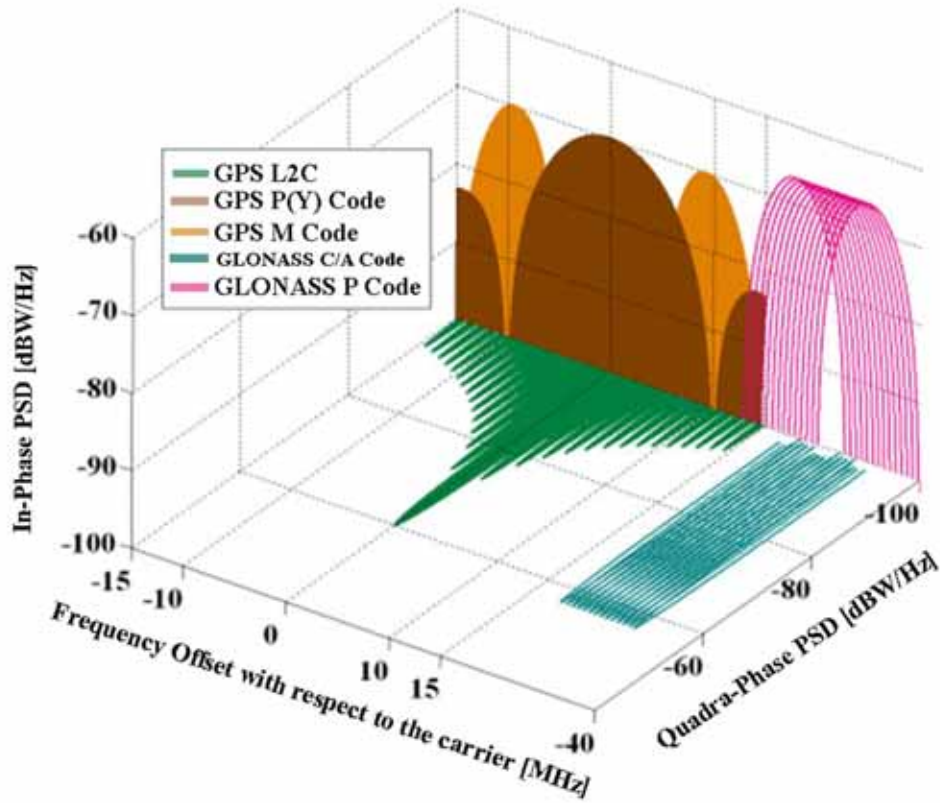

Figure 0r. Spectra of GPS and GLONASS signals in L2. Image courtesy of Dr. Jose Angel Avila Rodriguez.

GNSS System	GLONASS	GLONASS
Service Name	C/A Code	P Code
Center Frequency	(1242.9375-1248.625) MHz [+ or -] 0.511 MHz	
Frequency Band	L2	L2
Access Technique	FDMA	FDMA
Spreading modulation	BPSK(0.511)	BPSK(5.11)
Sub-carrier Frequency	-	-
Code Frequency	0.511 MHz	5.11 MHz
Signal Component	Data	Pilot
Primary PRN Code Length	511	N/A
Code Family	M-sequences	N/A
Meander sequence	100 Hz	N/A
Data Rate	50 bps	N/A
Minimum Received Power [dBW]	-167 dBW	N/A
Elevation	5°	N/A

Table 0g GLONASS L2 signal technical characteristics.

INDEX

A

- Absolute accuracy 409
- Absorption and scattering, 366
- Accuracy, digital chart 82
- Acoustic Doppler current profilers, 593
- Additional Secondary Phase Factor (ASF) 408
- Adjusting barometer readings, 669
 - advance 163
- Advance, 163
- Advanced piloting techniques, 179
- Advection fog, 628
- Aeronautical lights, 113, 114
- Agulhas Current, 591, 592
- Aids to navigation system, 91
- Air Almanac, 313
- Air masses, 615
- Alaska Current, 591
- Aleutian Current, 591
- Allowances for Non-Uniform Propagation Rates 408
- Almanacs, 102, 313, 431, 452
- Altering a great circle track to avoid obstructions, 199, 207
- Altitude correction, 316
- Altitude measurement, 432, 452
- Alto, 677
- Alto cumulus (Ac), 680
- Altostratus (As), 680
- Amplitude modulation (AM), 369
- Amplitude of radio waves, 361
- Amplitude of the sun by calculation, 277
- Amplitudes, 275, 295, 713
- AMVER participation, 496
- AMVER plot information, 496
- AMVER reporting, 496
- Anchorage, 177
- Anchoring procedures, 176
- Anemometer, 671
- aneroid barometer 667
- Aneroid barometer, 667
- Angle of magnetic dip, 136
- Anomalistic month, 570
- Antarctic Circumpolar Current, 588
- Antenna characteristics, 367
- Antilles Current, 589
- Antipode, 566
- Aphelion, 222
- Apogean tides, 570
- Apogee, 222
- Apparent horizon, 240
- Apparent motion, 220, 228
- apparent wind 671
- Apparent wind, 671
- Arc, 263, 282
- Area calls, 470
- Areas to be avoided, 457
- Aries, 233
- Artificial horizon sextants, 270
- Artificial horizon, 270
- Assumed latitude, 318
- Assumed longitude, 318
- Assumed position (AP), 314
- Astronomic latitude, 18, 236
- Astronomic longitude, 18, 236
- Astronomical Almanac, 295
- Astronomical distances, 220
- Astronomical triangle, 245
- Athwartship (A) coil, 145
- Atlantic ocean currents, 588
- Atmosphere, 607
- Atmospheric electricity, 632
- Atmospheric noise, 367
- Atmospheric pressure, 667
- Attenuation, 390
- Automated Mutual-Assistance Vessel Rescue System (AMVER), 473, 494
- Azimuth angle (Z), 713
- Azimuth of polaris, 274
- Azimuth of the sun, 295
- Azimuthal equidistant projection, 33, 41

Azimuthal orthomorphic projection, 40
 Azimuthal projection, 33, 39
 Azimuths, 241, 295

B

Back sight, 266
 Backwash, 604
 Bank cushion, 178
 Bank suction, 178
 barograph 668
 Barograph, 668
 barometer 667
 barometric pressure 667
 Barometric pressure, 667
 Barometric pressure, analysis of, 660
 baseline 407
 baseline extension 407
 Baseline, 20
 Basins, 562
 Bathymetric charts, 51
 Bathymetric navigation 1
 Beach sediments, 605
 Beacons, 116
 Beam compasses, 161
 Bearing (B, Brg.), 5
 Bearing record book, 166
 Beaufort Scale of wind force, 689
 Benguela Current, 591, 592
 blink coding 406
 Bobbing a light, 98
 Body at rising, 451
 Body at setting, 451
 Body in zenith, 456
 Body on prime vertical, 451
 Bore, 570, 602
 Bottom contour charts, 51
 Bottom description, 51
 Bottom relief, 562
 Brazil Current, 590
 Breaker, 598
 Breakers, classes of, 603
 Bridge lights, 113
 British Thermal Unit (BTU), 670
 Buoyage systems, 124

C

Calculations of meteorology, 714

Calculations of piloting, 307, 711
 Calculations of the sailings, 308, 713
 Calculator keys, 307, 711
 Calculators in navigation, 305, 711
 Calendar, 233
 California Current, 591
 Can, 125
 Canary Current, 590
 Cape Horn Current, 591
 Cardinal marks, 124
 Catalogs, 103, 108
 Causes of tides, 565
 Celestial equator, 237
 Celestial meridian, 237
 Celestial navigation 1
 Celestial navigation routine, 333
 Celestial sphere, 219, 237
 Celestial triangle, 245
 Celsius (C) 670
 Centering error, 269
 Characteristics of lights, 119
 Chart accuracy, 45
 Chart classification by scale, 44
 Chart dates, 48
 Chart features, 54
 Chart graticule, 34
 Chart lettering, 50
 Chart lighting, 61
 Chart numbering system, 57
 Chart numerical scale, 44
 Chart preparation, 162, 442
 Chart projection, 33
 Chart reading, 48
 Chart scales, 44
 Chart sounding datum, 51
 Chart soundings, 50
 Chart symbols and abbreviations, 128
 Chart symbols, 49
 Charts 2
 Chronometer error (CE), 6, 284
 Chronometer rate, 271, 284
 Chronometer time, 284
 Chronometer, 271
 Chronometers, 271
 Circulation of the atmosphere, 607
 Cirrocumulus (Cc), 678
 Cirrostratus (Cs), 678
 Cirrus 677

Cirrus (Ci), 677
 Clamp screw vernier sextant, 265
 Cloud Formation 676
 Cloud formation, 676
 Cloud height measurement, 686
 Clouds 676
 Clouds, 676
 Clutter, 392
 Coaltitude, 6
 Coast Earth Stations (CES), 469
 Coastal charts, 45
 Coastal current, 587
 Coastal phase 2
 Coastal refraction, 364
 Code division multiple access (CDMA), 376
 Codeclination, 6
 Cold wall, 589
 Collimation error, 270
 Colors of lights, 125
 Colors of marks, 125
 Comets, 226
 common establishment 572
 Communications, 707
 Comparing watch, 271
 Compass 3
 Compass checks, 444, 446
 Compass compensation, 111, 143
 Compass error, 153
 Compass operation, 140, 141
 Compasses, 3
 Compensating coils, 146
 Composite sailing, 207
 Compressibility, 559
 Computed altitude (hc), 712
 Computer Sight Reduction 313
 Conductivity-temperature-depth (CTD), 558
 Cone topmark, 125
 Conic projection, 37
 Conical buoy, 125
 Conn, 169
 Conning Officer, 169
 Continental shelf, 562
 Continental slope, 562
 Coordinate systems, 238
 Coordinates, 18
 Corona, 222, 235, 630
 Correcting and Uncorrecting the Compass 153
 Correcting compass, 140, 141

Correctors, 138
 COSPAS/SARSAT participants, 475
 Counter glow, 227
 Course deviation, 83, 85
 Course line 5
 Crepuscular rays, 632
 Critical point approach, 83, 86, 87
 Cross-track error, 83, 85
 Cumulonimbus (Cb), 685
 Cumulus (Cu), 677, 682
 Current 158
 Current diagrams, 584
 current ellipse 575
 Current ellipse, 575
 Current meters, 578
 Current rose, 575
 Current, 158
 Cygnus, 257
 Cylindrical projection, 33, 34

D

Danger bearings, 164
 Danger ranges, 164
 Danger soundings, 164, 443
 Date line, 283, 341, 342, 343, 345, 347, 350
 Datum shifts, 22
 Datum, 86
 Davidson Current, 591
 Day, 233
 Dead reckoning (DR) 1
 Dead reckoning (DR), 430, 449
 Dead reckoning plot, 135, 155
 Dead water, 602
 Deck ice, 626
 Deck log, 166, 430, 450
 Declination of a star, 299
 Declination of the moon, 297
 Declination of the sun, 297
 Deep Scattering Layer (DSL), 487
 Deep, 562
 Deep-Water route, 457
 Defense Mapping Agency Hydrographic/Topographic Center (DMAHTC) 10
 Defense Mapping Agency, 10
 Degaussing coils, 143
 degaussing compensation 143
 Degaussing compensation, 143, 146, 149
 Degaussing effects, 145

degaussing folder 143
 Degaussing folder, 143
 Degaussing stations, 143
 Degaussing system, 145
 Degaussing, 143, 149, 150, 151, 152
 Demarcation line, 166
 Density, 559
 Departure 4
 Departure (p, Dep.), 4, 156, 197
 Deperming, 145
 Depth contours, 51
 Depth conversion scale, 51
 Depths and datums, 51
 Developable surface, 33
 Deviation 3
 Deviation, 3, 138, 153
 Difference of latitude (l, Dlat.), 4, 197
 Difference of longitude (DLo), 4, 197
 Differential GPS (DGPS), 382
 Diffraction, 193, 366, 390
 Digital Nautical Chart (DNC), 75
 Digital Selective Calling (DSC), 472
 Dip correction, 712
 Dip of the sea short of the horizon, 712
 Dip, 316
 Direct motion, 225
 Direction on the earth, 5
 Dissemination systems, 287
 Distance (D, Dist.), 197
 Distance by vertical angle, 712
 Distance on the earth, 4
 Distance to the radar horizon, 712
 Distance to the visible horizon, 712
 Distances Between Ports (Pub. 151), 102
 Diurnal tide, 568
 Diversion, 706
 DNC corrections, 80
 Doldrums, 609
 Double high water, 570
 Double low water, 570
 Drag circle, 177
 drift 158
 Drift currents, 588
 Drift, 158, 167, 575
 Duel frequency correction techniques, 380
 Duration of slack water, 583

E

E layer, 364
 Earth, 3, 223
 East Auckland Current, 592
 East Australian Current, 592
 East Cape Current, 592
 East Greenland Current, 592
 East Wind Drift, 588
 Ebb, 575
 ECDIS Correction System, 79
 ECDIS Outputs, 71
 ECDIS Performance Standards, 65
 ECDIS warnings and alarms, 68
 ECDIS-N, 75
 Eclipses, 235
 Ecliptic, 223, 231
 Eddy viscosity, 560
 Effect of ice on waves, 598
 Effects of currents on waves, 598
 Effects of wind on the sea, 673
 Ekman layer, 587
 Ekman pumping, 587
 Ekman spiral, 588
 Ekman transport, 587
 Electric psychrometer, 671
 Electrical conductivity, 561
 Electromagnetic spectrum, 362
 electronic chart 63
 electronic chart data base 63
 Electronic Chart Display and Information System (ECDIS), 14
 Electronic chart display characteristics, 67
 Electronic Chart Standards, 66
 Electronic chart, 33
 Electronic Charts, 63
 Electronic Charts, correcting 79
 Electronic charts, using, 82
 Electronic navigation reports, 29, 490
 Electronic Notice To Mariners, 107
 Electronic systems, 9
 Ellipsoid of revolution, 17, 223
 Emergency navigation kit, 429
 Emergency navigation, 429
 Endless tangent screw vernier sextant, 265
 Energy of waves, 599
 Enhanced Group Call (EGC), 469
 Epicenter, 600
 EPIRB's (Category I, II), 474

EPIRB's (Class A, B, S), 473
 EPIRB's (Inmarsat-E), 474
 EPIRB's, alarm, warning, and alerting signals, 476, 480
 EPIRB's, testing, 475
 Equation of time, 280, 337
 Equator 4
 Equatorial Countercurrent, 592
 Equatorial jet, 592
 Equatorial tides, 570
 Equatorial undercurrent, 593
 Equinoctial, 237
 Equipment inventory, 442
 Error circle, 156
 Error, 387
 Errors in piloting, 181
 Established direction of traffic flow, 457
 estimated position (EP). 1
 Estimated position, 156, 158
 Estimated speed made good, 159
 estimated time of arrival 168
 Estimated track made good, 159
 Estimating the wind at sea, 673
 Evolutions prior to piloting, 168
 Expendable bathythermograph (XBT), 558
 Extremely high frequency, 369

F

F layer, 364
 Fading, 366
 Fahrenheit (F), 670
 False shoals, 27, 487
 Fast ice, 507
 Fathometer log, 166
 Fathometer operating guidelines, 444
 Fathometer, 176
 Fault lines, 557
 Federal Radionavigation Plan, 371
 fetch 674
 Fetch, 595, 674
 Finding the vertex, 206
 Fix by range and distance, 171
 Fix by two bearing lines, 168
 Fix by two ranges, 170
 Fix expansion, 157
 Fixed lights, 111
 Fixing position, 399
 Flashing, 145

Flaw lead, 507
 FleetNET, 469
 Flinders bar, 139
 Floating derelicts, 484
 Flood, 575
 Florida Current, 589
 Fog, 628, 676, 700
 Forecasting weather, 635
 Forecastle (F) coil, 144
 Foreign chart reproduction, 55
 Frazil ice, 503
 Frequency modulation (FM), 369
 Fronts, 615, 616, 617, 622

G

Galactic nebula, 228
 Galileo System 383
 Gauss, 143
 Gaussian error, 143
 Gegenschein, 227
 General charts, 44
 General circulation, 611
 General direction of buoyage, 126, 292
 Geocentric latitude, 19, 237
 Geodesic, 3
 Geodesy, 17
 Geodetic latitude, 18, 236
 Geodetic longitude, 18, 236
 Geodetic survey, 20
 Geodetic systems, 21
 Geographic latitude, 237
 Geographic longitude, 237
 Geographic range, 98
 Geometric dilution of precision (GDOP), 379
 Geostrophic equilibrium, 588
 Glacier, 499
 Glasses shade, 264
 Global Maritime Distress and Safety System, 467
 Global Positioning System (GPS), 9, 375, 730
 Globular clusters, 228
 Gnomonic projection, 33, 39
 GPS signal coding, 377, 735
 Graduation errors, 269
 Gravity waves, 595
 Gray-white ice, 505
 Grease ice, 503
 Great circle 3
 Great circle charts, 40, 200

Great circle sailing by computation, 202
 Great circle sailing by sight reduction tables, 200
 Great circle track, 5, 199
 Great circle, 3, 199
 Great Lakes ice, 523
 Green flash, 631
 Greenwich Hour Angle (GHA), 238
 Greenwich, 234
 Grids, 43, 56
 Ground swell, 598
 Groundwave, 365
 Group calls, 470
 Group time delay, 380
 Group velocity, 597
 Guinea Current, 590
 Gulf Stream, 589
 Gyrocompass 3
 Gyrocompass, 3

H

Halos, 630
 Handle, 264
 Harbor charts, 45
 Harbor/harbor approach phase 2
 Harmonic constants, 579
 harmonic tide plane 574
 Harvest moon, 226
 Haze, 628
 Heading relationships, 153
 hecto pascal (hPa) 667
 Heeling coil, 146
 Heeling magnet, 139
 Height error 669
 Heights, 52
 Hertz, 362
 High Clouds 677
 High clouds 677
 High frequency, 368
 High tide, 567
 High water datums, 574
 Horizon glass, 264
 Horizontal geodetic datum, 19
 Horse latitudes, 611
 Hull speed in knots, 711
 Humboldt Current, 592
 Humidity, 671
 Hunter's moon, 226
 Hydraulic current, 575

Hydrograms, 104
 Hydrographic surveys, 25
 hygrometer 671
 Hygrometer, 671

I

IALA Cardinal Marks, 126
 IALA Isolated Danger Mark, 127
 IALA Lateral Marks, 125
 IALA Maritime Buoyage System, 124
 IALA New Dangers, 127
 IALA Safe Water Marks, 127
 IALA Special Marks, 127
 Ice cake, 504
 Ice cap, 499
 Ice detection, 512
 Ice field, 505
 Ice floes, 505
 Ice forecasts and observations, 524
 Ice front, 501
 Ice operations, 516
 Ice rind, 503
 Ice wall, 501
 Ice, 484, 529, 675, 701
 Ice, density of, 510
 Icebergs in the North Atlantic, 502
 Icebergs, 499
 Identification of stars, 246
 Index arm, 263
 Index correction, 315, 316
 Index error, 270
 Index mirror, 263
 Indian Ocean Currents, 592
 Indian spring low water (ISLW), 574
 Indian tide plane 574
 Induced magnetism, 143
 Inertial navigation 1
 Inertial navigation system, 9
 Inferior conjunction, 224
 Inferior planets, 223
 Inland Waterway Phase 2
 Inland Waterway phase, 2
 Inmarsat (International Maritime Satellite Organization), 469
 INMARSAT B, 469
 INMARSAT C, 469
 Inshore current, 587
 Inshore traffic zone, 457

- Instrument error 669
 Integrated bridge, 263
 Intercardinal coils, 146
 Interference, 367
 Internal waves, 602
 International Association of Lighthouse Authorities, 14
 International charts, 56
 International Hydrographic Bureau (IHB), 56
 International Hydrographic Organization (IHO), 12, 56
 International Maritime Organization (IMO), 13
 International Regulations for Preventing Collision, 13
 Interpreting weather, 639
 Intracoastal Waterway aids to navigation, 130
 Ion, 363
 Ionosphere, 363
 Ionospheric delay errors, 379
 Irminger Current, 590
 Island shelf, 562
 Island slope, 562
 Isobars, 667
- J**
- Jamming, 367
 Japan Current, 591
 Jupiter, 225
- K**
- Kamchatka Current, 591, 593
 Knot (kn.), 4
 Kuroshio Current, 591
- L**
- Labrador Current, 590
 Lagging tides, 570
 Lambert conformal projection, 33, 38
 Land Earth Stations (LES), 469
 Land effect, 364
 Land ice, 499
 Large-scale chart, 44
 Lateral and cardinal systems, 124
 Lateral marks, 125
 Latitude (L, lat.), 4, 197, 198, 236, 701
 Latitude at meridian passage, 330
 Latitude by Polaris, 332
 Latitude determination, 6, 434, 455
 Latitude of the vertex, 714
 Latitudes of points on the great-circle track, 714
 Leap seconds, 290
 Leap-second adjustments, 290
 Leeuwin Current, 592
 Leeway 158
 Leeway, 158
 Length of sea waves, 715
 Length of the day, 455
 Leveling, 20
 Light characteristics, 119
 Light Lists, 96
 Light sectors, 122
 Light-year, 221
 Limb, 263
 Line of apsides, 222
 Line of position, 7, 314
 List of Lights, 99
 Local Hour Angle (LHA), 238, 318
 Local Mean Time (LMT), 286
 Local Notice To Mariners, 104
 Local time, 234
 Local wind names, 612
 Local winds, 625
 Location vessel, 497
 Log 3
 Log, 3
 Longitude (l, long.), 4, 198, 236
 Longitude at meridian passage, 331
 Longitude determination, 6
 Longitudinal (L) coil, 145
 Longshore current, 587, 605
 Loop Current, 589
 Loran C Signal 404
 Loran C Theory 407
 Low clouds 677
 Low clouds, 682
 Low frequency, 368
 Low tide, 567
 low water datum 574
 Low Water Datums 573
 Lower branch 3
 Lower branch, 237
 lower low water datum 574
 Lowest low water, 574
 Lowest normal low water, 574
 Loxodromic curve, 4

Luminous range, 97
 Lunar day, 234
 Lunar distance, 7
 Lunar eclipse, 236
 Lunar month, 570
 lunital interval 572
 Lunitidal interval, 572

M

Magnetic adjustment, 138
 Magnetic disturbances, 490
 Magnetic fields, 138, 139
 Magnetic heading, 153
 Magnetic poles, 135
 Magnetic signature, 143
 Magnitude ratio, 221, 239, 241
 Magnitudes, 221
 Main (M) coil, 144
 Major light, 111
 Major wind patterns, 609
 Malvinas Current, 590
 Maneuvering to avoid the storm center, 661, 663, 664
 Manganese nodules, 563
 Marcq Saint Hilaire, 103
 Marine chronometer, 271
 Marine information reports, 488
 marine microbarograph 668
 Marine sediments, 562
 Marine sextant, 263
 Maritime Safety Information (MSI), 447, 469
 maritime safety information, 467
 Mars, 225
 mean high water (MHW) 574
 Mean high water lunitidal interval, 572
 mean high water springs (MHWS) 574
 mean higher high water (MHHW) 574
 Mean latitude (Lm), 198
 Mean low water (MLW), 573
 Mean low water springs 573
 Mean low water springs (MLWS), 573
 Mean lower low water (MLLW) 574
 Mean lower low water (MLLW), 573
 Mean lower low water springs (MLLWS) 574
 Mean lower low water springs (MLLWS), 573
 Medium frequency, 368
 Mercator projection, 33, 34
 Mercator sailing, 213, 714

mercurial barometer 667
 Meridian 3
 Meridian altitude, 455
 Meridian angle, 237
 Meridian passage, 330
 Meridian transit, 451
 Meridional difference (m), 198
 Meridional parts (M), 34, 198
 Meteor showers, 226
 Meteor swarms, 226
 Meteors, 226
 Micrometer drum sextant, 263
 Micrometer drum, 264
 Microwaves, 362
 Middle clouds 677
 Middle clouds, 680
 Mid-latitude (Lm), 4, 198
 Mid-latitude sailing, 199, 212, 713
 Military ECDIS, 75
 Mindanao Current, 592
 Mines, 486
 Minimum expected sounding, 442
 Minor light, 111
 Mirage, 628
 Miscellaneous chart features, 54
 Mist, 628
 Mixed tide, 569
 Modified facsimile charts, 55
 Modified Lambert conformal, 42
 Modulation, 369
 Moon, 225
 Moonrise, 301
 Moonset, 301
 Most probable position (MPP), 429, 448

N

Nadir, 237
 National Marine Electronic Association (NMEA), 14
 National tidal datum epoch, 574
 Nautical Almanac, 298
 Nautical chart, 25, 33
 Nautical mile 3
 Nautical miles, 711
 Nautical texts, 91
 NAVAIDS, 162
 Navigation calculations, 375, 711
 Navigation, four phases of, 1

Navigational astronomy, 273
 Navigational error, 387
 Navigational mathematics, 361
 Navigational tables, 8
 Navigational triangle, 6, 245
 Navigator, 169
 NAVTEX, 471
 Navy Navigation Satellite System (NAVSAT), 8, 375
 Neap tides, 570
 Nebula, 228
 Negative pole, 136
 Neptune, 225
 Network Coordination Station (NCS), 469
 New danger, 127
 New Guinea Coastal Current, 592
 Ney's projection, 42
 Night effect, 366
 Night observations, 676
 Night orders, 444
 Nilas, 503
 Nimbostratus (Ns), 684
 Nimbus, 677
 No. 2102D 259
 NOAA BSB corrections, 80
 Nodal period, 570
 Nodes, 235
 Noise, 367
 Nominal range, 96
 Nontidal current 575
 Nontidal current, 575
 North American Datum, 1983, 22
 North Atlantic Current, 590
 North Cape Current, 589
 North Equatorial Countercurrent, 589, 591
 North Equatorial Current, 589, 590, 591
 North Pacific Current, 591
 North pole, 136
 North wall effect, 700
 Northeast Drift Current, 590
 Norway Current, 590
 Notice To Mariners, 104
 Nova, 228

O

Oblique gnomonic projection, 39
 Oblique Mercator projections, 36
 Oblique orthomorphic projection, 36

Obliquity of the ecliptic, 231
 Ocean current observations, 593
 Ocean current phenomena, 593
 Ocean current reports, 32, 493
 Ocean currents and climate, 593
 Ocean currents, 483, 700
 Ocean currents, causes, 587
 Ocean eddies and rings, 593
 Ocean phase, 2
 Ocean pressure, 558
 Ocean temperature, 558
 Ocean waves, 595
 Oceanic circulation, 588
 Oceanographic chemistry, 557
 Oceanography, 557
 Offshore current, 587
 Open cluster, 228
 Opposition, 225
 Origin of the oceans, 557
 Orion, 254
 Orthographic projection, 34, 41
 Orthomorphic projection, 40
 Oscillatory wave, 598
 Overfalls, 598
 Oyashio Current, 591

P

Pacific ocean currents, 591
 Pancake ice, 504
 Parallax, 455
 Parallel 4
 Parallel sailing, 199, 210, 713
 Pegasus, 250
 Perigean spring tides, 570
 Perigean tides, 570
 Perigee, 222
 Perihelion, 222
 Periodic current, 587
 Permanent magnetism, 138
 Permanent magnets, 139
 Perspective projections, 34
 Peru Current, 592
 Phase characteristics of lights, 125
 phase coding 406
 Photosphere, 222
 Pillar buoys, 125
 Piloting 1
 Piloting brief, 167

Piloting procedures, 175
 Piloting, 155
 Pilots, 2
 Plan position indicator (PPI), 388
 Plane projections, 34
 Plane sailing triangle, 208
 Plane sailing, 199, 208, 713
 Planet diagram, 259
 Plates, 557
 Plotting running fixes, 179
 Plotting sheets, 43, 430, 448
 Plotting the DR, 156
 Plunging breaker, 603
 Pluto, 225
 Points along the great circle, 204
 Polar charts, 42
 Polar distance (p), 238
 Polar projection, 42, 43
 Polar winds, 611
 Polaris, 451
 Polarization error, 366
 Polarization, 363
 Polyconic projection, 33, 39
 Port information reports, 490
 Position reporting systems, 494
 Positive pole, 136
 Precautionary area, 457
 Precipitation, 675
 Precise positioning service (PPS), 377
 Prime meridian 2
 Priming tides, 570
 Prismatic error, 268
 Projections, 33
 Proper motion, 228
 Pseudorandom noise (PRN), 376
 psychrometer 671
 Psychrometer, 671
 Psychrometric tables, 671
 Pulse modulation (PM), 369

Q

Quadrantal spheres, 139
 Quarterdeck (Q) coil, 144
 Quartz crystal marine chronometers, 271

R

Racons, 397
 Radar beacons, 397
 Radar interpretation, 390
 Radar navigation 1
 Radar piloting, 398
 Radar ranges, 170
 Radar reflectors, 396
 Radar, development of, 9
 Radial motion, 228
 Radiation fog, 628
 Radio navigation 1
 Radio Navigational Aids (Pub. 117), 99
 Radio propagation factors, 288
 Radio spectrum, 362
 Radio Technical Commission for Maritime Services, 14
 Radio wave propagation, 368
 Radio waves, 361
 Radioactivity, 561
 Rage sea, 599
 Rainbow, 629
 Ramarks, 397
 Rams, 501
 Range lights, 113
 Ranges, 163
 raster chart display system, 64
 raster navigation chart, 64
 Receivers, 370
 Recommended direction of traffic flow, 457
 Recommended routes, 457, 458
 Recommended track, 457
 Recording observations, 688
 Rectangular projection, 36
 Reducing a moon sight, 325
 Reducing a planet sight, 329
 Reducing a sun sight, 323
 Reducing star sights, 318
 reference plane 573
 Reflection, 189, 363
 Refraction of radio waves, 191, 364
 Refraction, 390, 454, 598, 603
 Registered Information Provider, 469
 Regression of the nodes, 236
 Regulated waterways, 466
 Regulation of frequency use, 369
 Relative accuracy 409
 Relative humidity, 671

- Relative motion, 220
 - Release, 263
 - Repeatable accuracy 409
 - Representative fraction, 44
 - Requirements, ECDIS replacing paper charts, 64
 - Resolution in bearing, 390
 - Resolution in range, 390
 - Retentive error, 142
 - Retrograde motion, 225
 - Revolution, 221
 - Rhumb line 4
 - Rhumb lines, 4, 199
 - Rip currents, 605
 - Ripples, 595
 - Rotation, 221
 - Roundabout, 457
 - Route planning and monitoring, 83
 - Route reports, 493
 - Routing system, 457
 - Royal Greenwich Observatory, 11
 - Rules of dead reckoning, 156
 - Running fix, 171
- S**
- Safe Water Marks, 127
 - Safety contour, 83, 85
 - Safety of Life at Sea (SOLAS), 13
 - Safety report messages, 486
 - SafetyNET, 469
 - Sailing charts, 44
 - Sailing Directions 2
 - Sailing Directions (Planning Guide), 91
 - Salinity, 557
 - Sand bars, 605
 - Sargasso Sea, 590
 - Saros, 236
 - SART Range 478, 479
 - Satellite navigation 1
 - Satellite oceanography, 564
 - Saturn, 225
 - Scale, 43
 - Sea ice, 503
 - Sea ice, drifting, 510
 - Sea ice, salinity, 509
 - Sea ice, thickness, 507
 - sea level pressure 670
 - search and acquisition 404
 - Seasonal current, 587
 - Secant conic projection, 38
 - Secchi disk, 561
 - Sectors of lights, 122
 - Seiche, 601
 - Seismic sea waves, 600
 - Semidiameter, 455
 - Semidiurnal tide, 568
 - Semidiurnal, 576
 - Separation zone, 457
 - Set 158
 - Set, 158, 167, 575
 - Sextant care, 268
 - Sextant errors, adjustable, 269
 - Sextant errors, non adjustable, 268
 - Sextant moon sights, 265
 - Sextant reading, 266
 - Sextant star sights, 265
 - Sextant sun sights, 265
 - Sextant verticle angles, 171
 - Shade glasses, 264
 - Shallow water, 675
 - Shapes of marks, 125
 - Ship Earth Stations (SES), 469
 - Ship simulators, 184
 - Ship's heading, 153
 - Ship's magnetism, 138
 - Shoaling, 598
 - Shoals, 484
 - Shore lead, 507
 - Shore lights, 114
 - Shuga, 503
 - Side error, 269
 - Sidereal day, 233
 - Sidereal Hour Angle, 233, 318
 - Sidereal month, 225
 - Sidereal time, 233, 286
 - Sight reduction procedures, 315
 - Sight Reduction Tables, 103
 - Sight reduction, 337, 434, 455
 - Signal range, 368
 - signal-to-noise ratio (SNR) 409
 - Simple conic projection, 37
 - Skip distance, 365
 - Sky coloring, 629
 - Sky diagrams, 249
 - Slack water, 575
 - Slide Bar 164
 - Slide bar, 164

- Sling psychrometer, 671
 Small circle 3
 Small circle, 3
 Small craft charts, 45
 Small-scale chart, 44
 Smog, 628
 Solar eclipse, 235
 Solar prominences, 235
 Solar System 221
 Solar tide, 569
 Solar time, 279, 337, 348
 Solar wind, 223
 Somali Current, 592
 Sound signals, 123
 Sound speed, 560
 sounding datum 573
 Sounding datum, 573
 Sounding reports, 26
 Soundings, 50
 South Atlantic Current, 590
 South Equatorial Current, 589, 592
 South Java Current, 592
 South Pole, 136
 Southeast Drift Current, 590
 Southern hemisphere routing, 707
 Southern Ocean Currents, 588
 Southwest Monsoon Current, 592
 Space segment, 469
 Spar, 125
 Special charts, 43, 56
 Special environmental problems, 706
 Special Marks, 127
 Special Notice to Mariners paragraphs, 104
 Special purpose buoys, 130
 Special tidal effects, 570
 Specific heat, 560
 Speed (S), 4
 Speed made good (SMG), 5
 Speed of a vessel, 711
 Speed of advance (SOA), 4
 Speed over the ground (SOG), 4
 Spherical buoys, 125
 Spherical triangle, 245
 Spicules, 503
 Spilling breaker, 603
 Spitsbergen Current, 590
 Spring tides, 570
 Squat, 178
 Stadimeter ranges, 171
 Standard parallel, 37
 Standard time broadcasts, 288, 291
 Standing orders, 444
 Standing waves, 601
 Star charts, 247
 Star clouds, 228
 Star finder, 249, 259
 Star globe, 249
 Stars, 227, 246
 station pressure 669
 Steering error, 158
 Stereographic projection, 34, 40
 Storm tides, 600
 Stratocumulus (Sc), 683
 Stratus (St), 684
 Stream, 588
 Subastral point, 245
 Sublunar point, 245, 566
 Subpermanent magnetism, 138
 subpolar regions 529
 Subsattellite point, 245
 Subsolar point, 245
 Substellar point, 245
 Summary Of Corrections, 106
 Sumner line, 7
 Sun 222
 Sunspots, 222
 Super high frequency, 369
 Superior conjunction, 224
 Superior planets, 225
 Supernova, 228
 Super-refraction, 364
 supersaturated 671
 Surf, 598
 Surging breaker, 603
 Sweat, 671
 Swell, 595, 675
 Swing circle, 177
 Synodic period, 225
 Synodical month, 570
 Synoptic oceanography, 564
 Synoptic weather considerations, 701

T

- Tabular iceberg, 501
 Tabular Sight Reduction 313
 Taking a sight, 265

- Taking departure, 156
 - Tangent screw, 263
 - Tasman Front, 592
 - Telescope, 264
 - Temperature 670
 - Temperature error 670
 - Temperature measurement, 670
 - Temporary geographic grid (TGG), 44
 - Terrestrial magnetism, 136
 - The sailings 3
 - The Sailings, 3, 403
 - Thermal conductivity, 561
 - Thermal expansion, 560
 - Thermocline, 558
 - Thermohaline, 587
 - thermometer 670
 - Tidal current charts, 583
 - Tidal current periods and cycles, 577
 - Tidal current tables, 579, 581
 - Tidal current, 158, 575
 - Tidal currents, 579, 675
 - Tidal cycles, 573
 - tidal day 572
 - Tidal day, 570
 - Tidal heights, 579
 - Tidal waves, 600
 - Tide calculations, 307, 712
 - Tide predictions for reference stations, 580
 - Tide predictions for subordinate stations, 580
 - Tide Tables, 580
 - Tide waves, 602
 - Time balls, 6
 - time delay lattice 404
 - time difference 404
 - Time meridian, 283
 - Time of sunset, 300
 - Time sight, 7
 - Time signals, 288
 - Time, 233, 305
 - Topmarks, 125
 - Track made good by plotting running fixes, 179
 - tracking and lock phase 404
 - Trackline SURPIC, 497
 - tractive forces 566
 - Trade winds, 609
 - Traffic lane, 457
 - Traffic separation scheme, 457, 458
 - transfer 163
 - Transfer, 163
 - Transit of the sun, 224
 - Transition to piloting, 168
 - transmissometer 688
 - Transmissometer, 561, 688
 - Transparency, 561
 - Transverse Mercator projections, 35
 - Transverse orthomorphic projection, 35
 - Transverse projections, 33
 - Traverse sailing, 199, 210, 713
 - Traverse tables, 207
 - Traverse, 20, 210
 - Triangulation, 20
 - Trilateration, 20
 - tropic higher high water (TcHHW) 574
 - Tropic lower low water (TcLLW), 574
 - Tropic tides, 570
 - Tropical month, 570
 - Tropical year, 234
 - True heading, 153
 - True wind, 671
 - Tsunamis, 600
 - Tsushima Current, 591
 - turbidity currents 563
 - Turbidity currents, 563
 - turning point 163
 - Twilight, 300
 - Two-way route, 458
 - Types of marks, 125
- U**
- U.S. Coast and Geodetic Survey, 9
 - Ultra high frequency, 369
 - Undercurrents, 593, 594
 - United States Coast Guard, 11
 - United States Naval Observatory, 11
 - United States Navy, 11
 - Universal polar stereographic (UPS) grid, 40, 44
 - Universal time, 234
 - Universal Transverse Mercator (UTM), 35, 44
 - Upper air observations, 688
 - Upper branch 3
 - Upper branch, 237
 - Uranus, 225
 - Ursa Major, 254
 - USCG Light Lists, 99
 - Use and stowage of charts, 61
 - User equivalent range error (UERE), 379

Using charts, 59

V

Variable stars, 228
 Variation 3
 Variation, 3, 136, 153
 Vernier sextant, 264
 Vernier, 264
 Vertical surveying, 20
 Very high frequency, 368
 Very low frequency, 368
 Vessel Traffic Services (VTS) 11
 Viscosity, 559
 Visibility 688
 Visibility measurement, 688
 Visible horizon, 240
 Voluntary Observation Ship (VOS) program 668
 Voyage preparation, 442
 VTS Houston-Galveston, 464
 VTS Prince William Sound, 464, 465
 VTS Puget Sound, 463

W

Warning Sounding, 443
 Warship ECDIS (WECDIS), 78
 Watch relief procedures, 445
 Watch Time (WT), 285
 Waterspout, 626
 Wave characteristics, 595
 Wave front, 362
 Wave height, 499, 700, 715
 Wave interference, 363
 Wave measurement aboard ship, 599
 Wave period (P), 595
 Wave speed, 715
 Wavelength, 362, 595
 Waves, causes, 499
 waypoints 404
 Waypoints, 87
 Weather forecast dissemination, 635

Weather observations, 587, 641
 Weather routing, 595, 667, 697
 Weather, 557, 607
 West Greenland Current, 590
 West Wind Drift, 588
 Western Rivers System, 130, 131
 Wind driven currents, 587
 Wind measurement, 671
 Wind shifts, 675
 Wind speed, 674
 wind vane 671
 Wind, 700
 Wind's duration, 674
 World Geodetic Reference System (GEOREF), 43
 World Geodetic System of 1960, 21
 World Geodetic System of 1972, 21
 World Geodetic System of 1984, 21
 World Geodetic System, 21
 World Port Index Pub. 150, 102
 Wrecks/man-made obstructions, 484

X

X-shaped topmarks, 125

Y

Year, 233
 Young ice, 505

Z

Zenith distance, 241
 Zenith, 237
 Zenithal projection, 33, 39
 Zodiac, 233
 Zodiacal light, 227
 Zone description (ZD), 283
 Zone meridian, 283
 Zone time (ZT), 234, 283