

US ARMY INTELLIGENCE CENTER

INTRODUCTION TO RADIO
DIRECTION FINDING

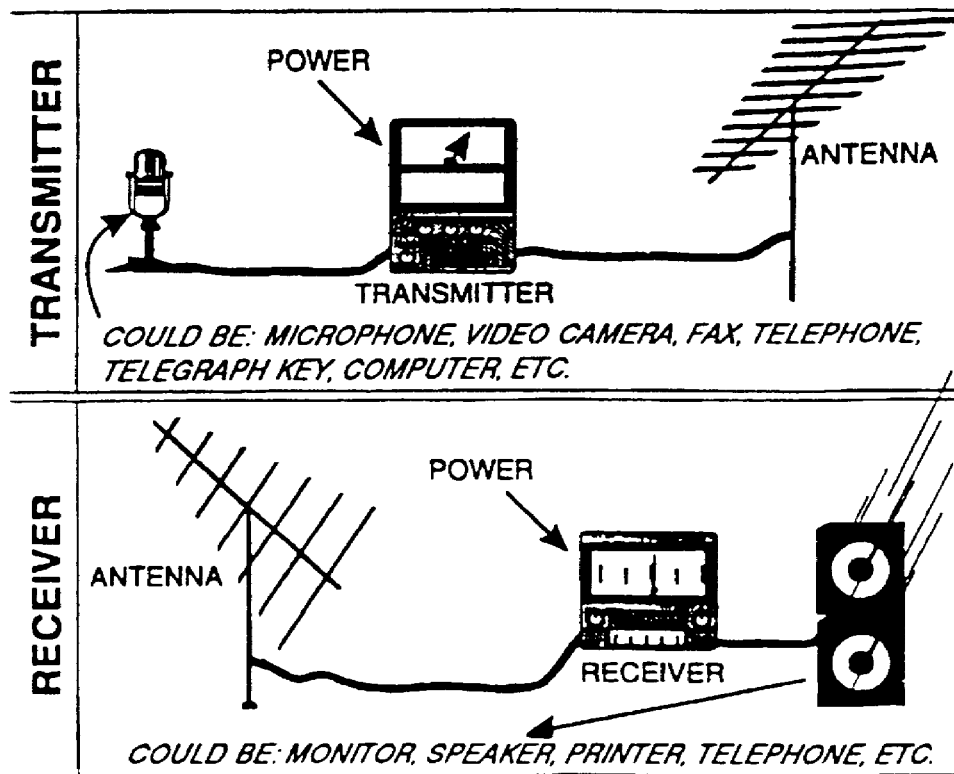

THE ARMY INSTITUTE FOR PROFESSIONAL DEVELOPMENT
ARMY CORRESPONDENCE COURSE PROGRAM

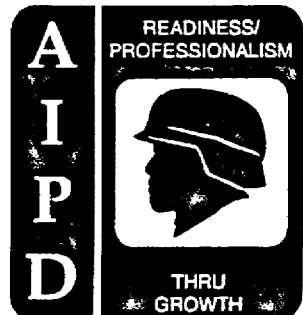

INTRODUCTION TO RADIO DIRECTION FINDING

Subcourse Number IT0302

EDITION C

US ARMY INTELLIGENCE CENTER
FORT HUACHUCA, AZ 85613-6000

5 CREDIT HOURS

EDITION DATE: AUGUST 1999

SUBCOURSE OVERVIEW

This subcourse is designed to teach you the basic concepts and minimum equipment requirements of radio direction finding (DF) as it is practiced in the Army today. The applications of DF are varied, with each application having its own requirements. You will be introduced to the basic terms and concepts of DF necessary to understand its application to other specialists or to prepare for the complete DF course.

There are no prerequisites for this subcourse.

TERMINAL LEARNING OBJECTIVE

ACTION: You will select the basic terminology/concepts of DF, and select the basic equipment requirements for a radio DF system and certain concepts needed for discussion of DF equipment.

CONDITION: You will use information provided in this subcourse.

STANDARD: To demonstrate competency of this task, you must achieve a minimum of 70 percent on the subcourse examination.

REFERENCES: The material contained in this lesson was derived from the following publications:

FM 34-40-0(U)	FM 11-666
FM 11-64	FM 30-476
FM 34-86	

TABLE OF CONTENTS

<u>Section</u>	<u>Page</u>
Subcourse Overview	i
Lesson 1: Basic Terminology	1-1
Introduction	1-1
Part A: Radio Wave Propagation	1-2
Part B: Properties	1-13
Part C: Elements	1-18
Practice Exercise	1-23
Answer Key and Feedback	1-26
Lesson 2: Equipment Requirements	2-1
Introduction	2-1
Part A: Components	2-2
Part B: Definitions	2-4
Part C: Requirements	2-7
Practice Exercise	2-19
Answer Key and Feedback	2-22

LESSON 1

BASIC TERMINOLOGY

CRITICAL TASK: None

OVERVIEW

LESSON DESCRIPTION:

Upon completion of this lesson you will be able to show your understanding of the basic terminology and concepts of direction finding by matching terms and concepts with correct explanations.

TERMINAL LEARNING OBJECTIVE:

TASK: Identify with the basic terminology and concepts of direction finding.

CONDITION: Given the information provided in this subcourse.

STANDARD: To demonstrate competency of this task, you must achieve a minimum of 70 percent on the subcourse examination.

REFERENCES: The material contained in this lesson was derived from the following publications:

FM 34-40-0(U)
FM 11-666
FM 11-64
FM 30-476
FM 34-86

INTRODUCTION

Radio direction finding deals with the direction of arrival of radio waves. Therefore, it is necessary to understand the basic principles involved in the propagation of radio waves from the transmitting station to the DF equipment.

PART A: RADIO WAVE PROPAGATION

The distance traveled by a radio wave during a single cycle is known as a wavelength. A wavelength can be expressed in any unit of measure. However, it is normally expressed in meters. The number of complete waves that move past a given point in one second is called frequency. A unit of frequency is called Hertz (Hz). One unit is equal to one cycle per second (Figure 1-1). The radio wave's strength or intensity is called its amplitude.

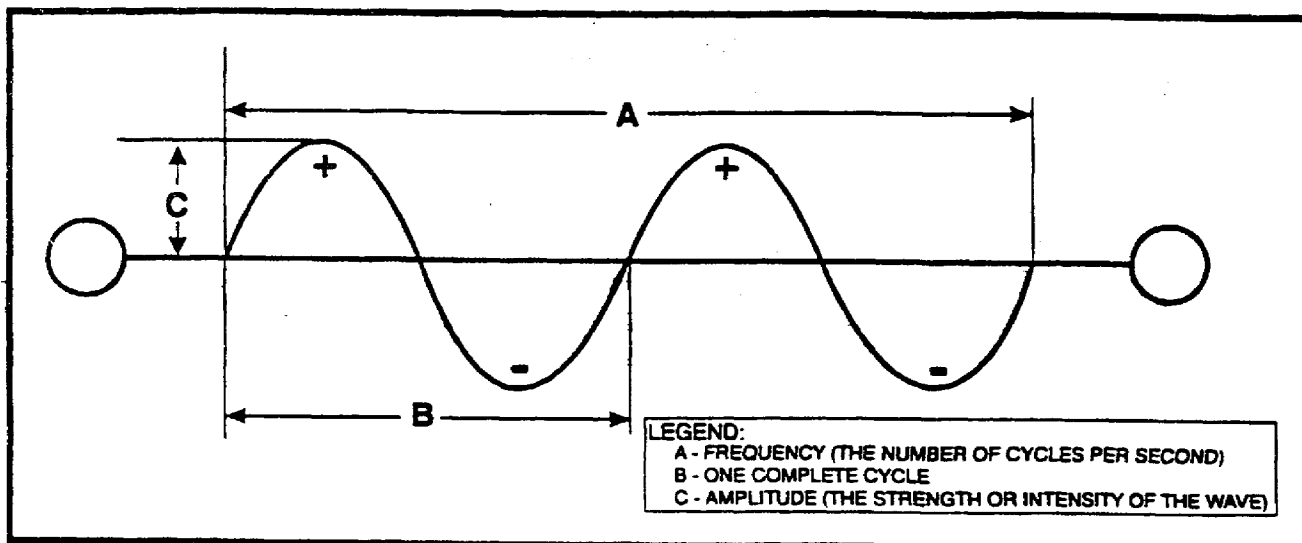

The radio wave, which is electromagnetic in nature, consists of an electrical field (E field) and a magnetic field (H field). Each field supports the other, and neither can be propagated by itself. Table 1, lists frequency bands, their designators, and the commonly accepted limits of each band.

The direction of the E field of a radio wave, relative to the ground, determines the polarization of the wave. Polarization can either be horizontal, vertical, or a mutation which adopts portions of vertical and horizontal. The latter results in a circular or hybrid form of a wave. If a whip or other vertical type transmitting antenna is used to propagate radio waves, the transmitted wave is considered to be vertically polarized. If the transmitting antenna is horizontal, relative to the earth's surface, the transmitted wave is horizontally polarized.

Table 1. Frequency range and band designator.

FREQUENCY RANGE		BAND DESIGNATOR
3-30	kilohertz (kHz)	very low frequency (VLF)
30-300	kHz	low frequency (LF)
300-3000	kHz	medium frequency (MF)
3-30	megahertz (MHz)	high frequency (HF)
30-300	MHz	very high frequency (VHF)
300-3000	MHz	ultra high frequency (UHF)
3-30	gigahertz (GHz)	super high frequency (SHF)
30-300	GHz	extremely high frequency (EHF)

To illustrate vertical wave polarization, imagine a rope lying reasonably straight on the ground. One end is attached to a tree or other support (Figure 1-2). If the loose end of the rope is raised, tightened, and given a violent up and down motion, a series of undulating waves will travel along the rope. The movement of the waves will be vertical to the earth and clearly visible.

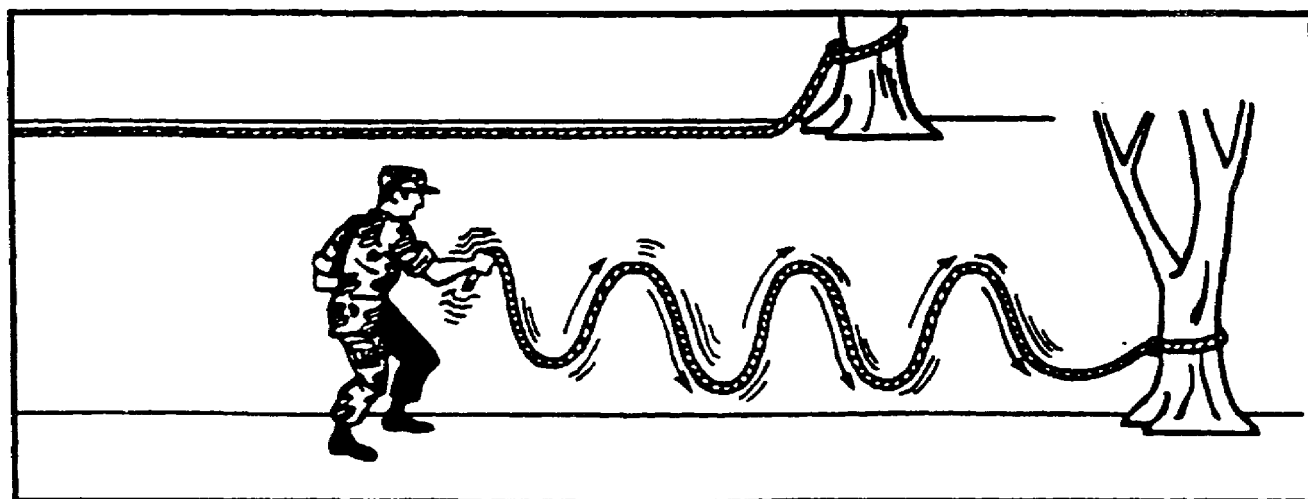

Figure 1-2. Vertical wave polarization.

If the same rope had a similar movement applied in a horizontal manner, the waves would be in a horizontal plane. These waves would be called horizontally polarized (Figure 1-3).

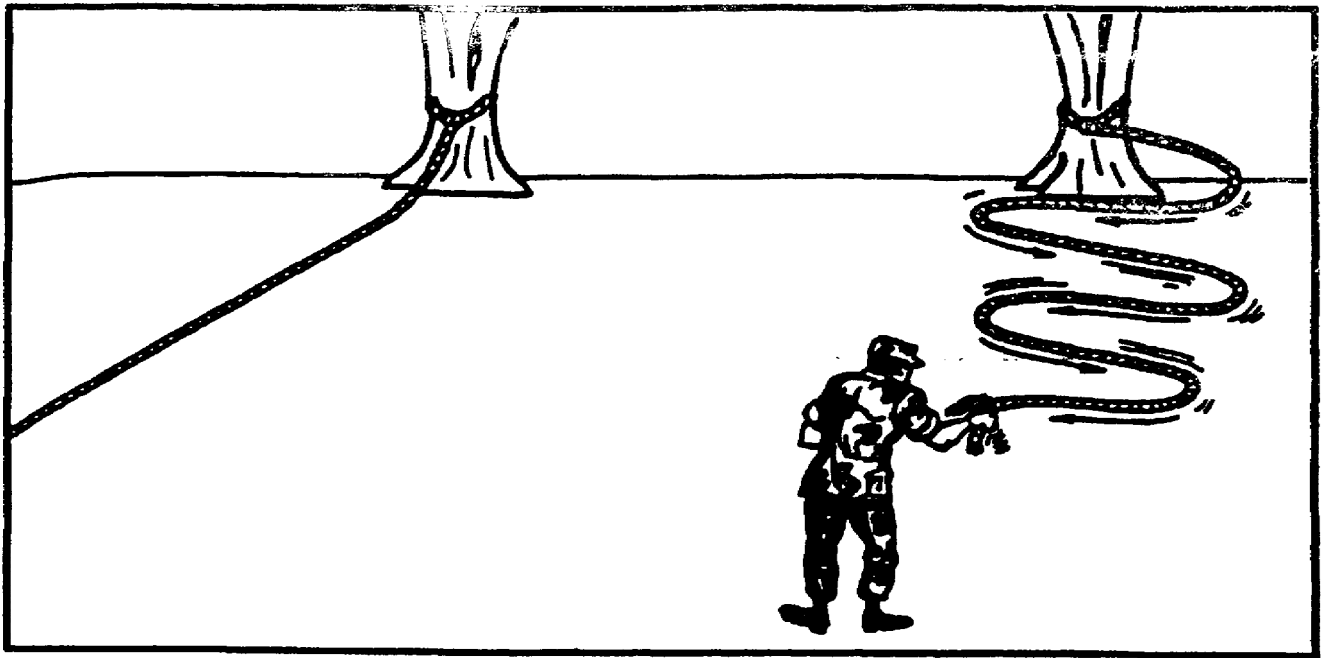

Figure 1-3. Horizontal wave polarization.

Wavelength, frequency, and polarization are all essential elements of the actual wave and are factors which affect the radio wave propagation. The simplest form of propagation is through space. Radio waves tend to travel in straight lines unless they are acted on by some force. They can be reflected off the surface of any sharply defined object such as the earth's surface. The radio waves can also meet other obstructions or objects that will scatter or reflect the signal. They can be reflected, refracted, or diffracted.

Radio waves are reflected similar to light waves traveling at the same speed. Although light waves can be seen, radio waves must be detected by electronic equipment. Figure 1-4 illustrates how radio waves are reflected off the ionosphere.

Refraction can best be illustrated by a pencil held obliquely so that a portion of it is beneath the surface of some water (Figure 1-5). From most viewpoints, the pencil will have the appearance of being bent at the point where it enters the water. This effect is because light waves travel more slowly in water than air.

Diffraction of a radio wave is the phenomena of bending the wave around a solid object. The lower the frequency or the longer the wavelength, the greater the bending of the wave. Therefore, radio waves are more readily diffracted than light waves. Sound waves are more readily diffracted than radio waves. This illustrates why sound waves can be heard around the corner of a large building.

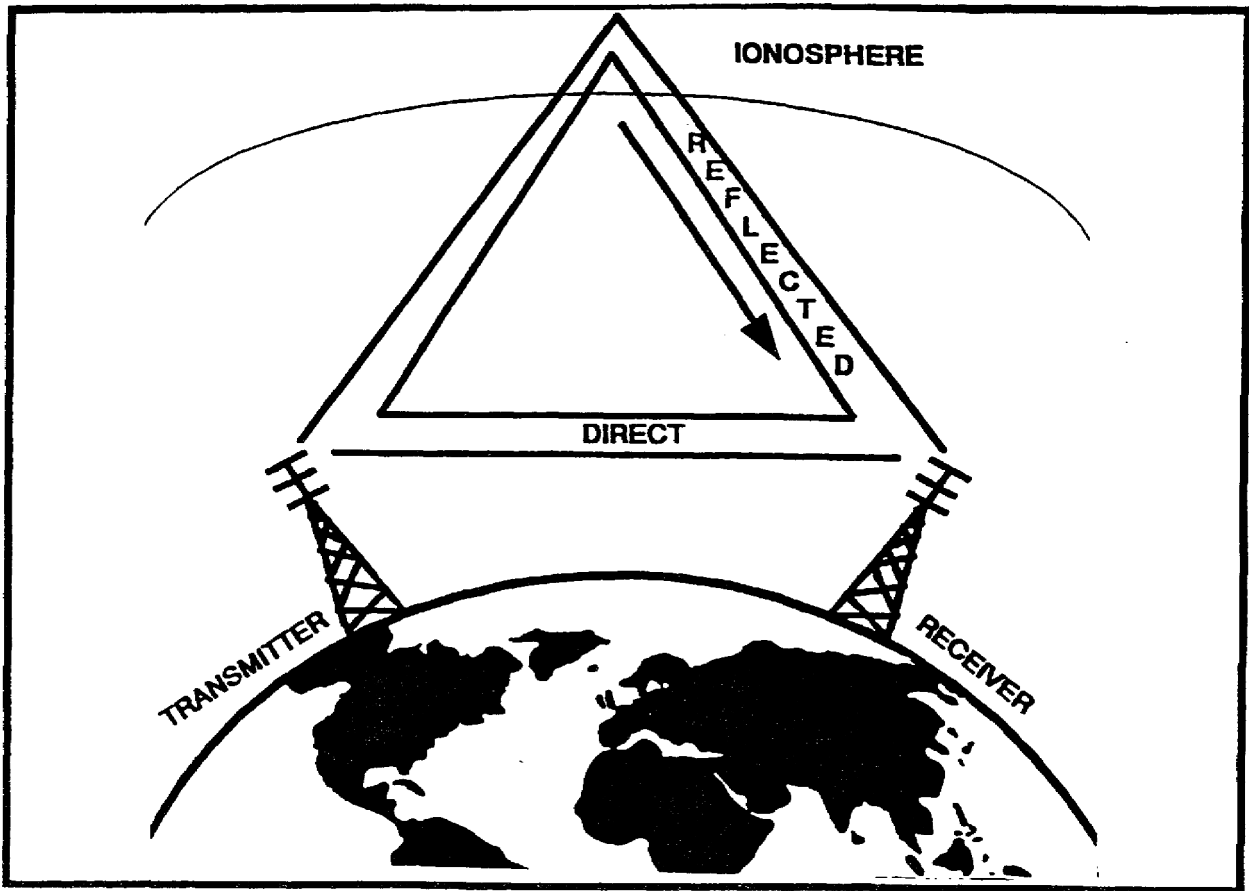

Figure 1-4. Reflected radio waves.

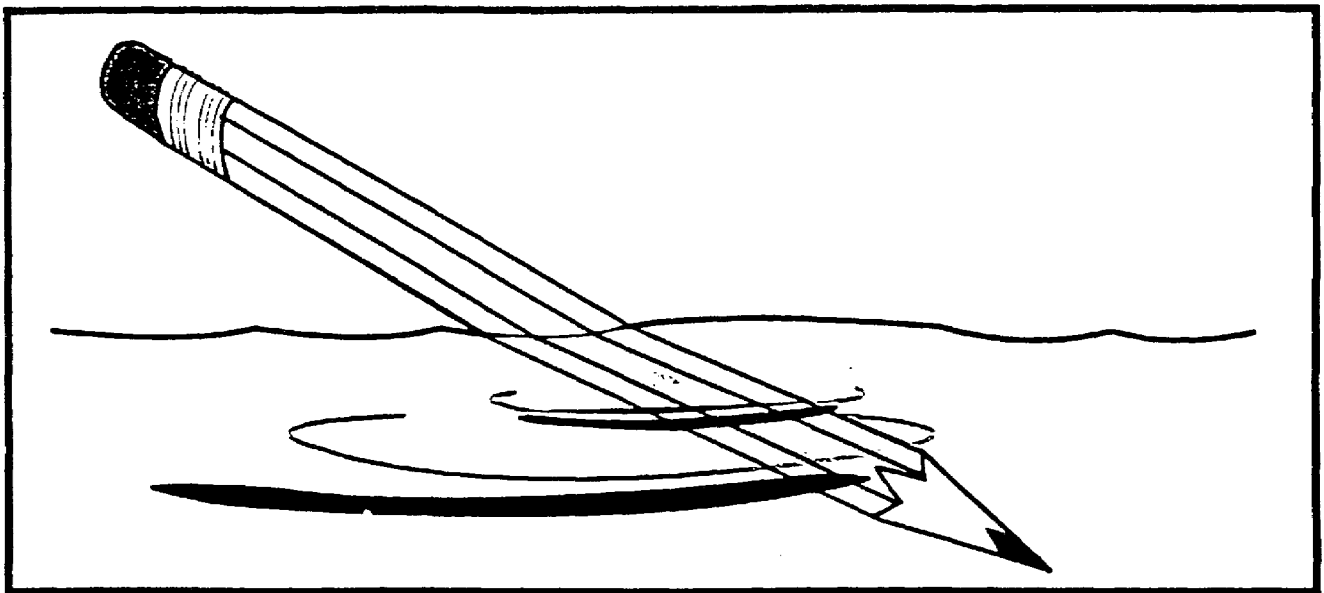

Figure 1-5. Refraction of a pencil.

The earth's atmosphere plays a crucial role in long distance radio communications. Radio waves may be reflected in the atmosphere and returned to earth. This technique is discussed later in this lesson. As shown in Table 2, the atmosphere consists of multiple layers, of which only a few have any discernible effect on radio waves. The ionosphere is the primary layer that is used to return a radio wave back to earth.

Table 2. Characteristics of the atmosphere.

ATMOSPHERIC REGION	LOCATION (Km)	FEATURES	EFFECT ON COMMUNICATIONS (Radio Frequency)
Ionosphere	Extending 50-600 km from the earth's surface.	Electrically charged set of layers, with large amounts of free electrons.	Excellent reflection/refraction of MF and HF signals. Some VHF may be propagated as well. Primary medium for sky wave communications.
Stratosphere	Extending 15-50 km from the earth's surface.	The only isothermal region of the atmosphere.	No effect.
Troposphere	From earth's surface to 10-15 km.	Lowest region of the atmosphere. Sustains life. Temperature decreases with increasing altitude.	Negligible effect. Allows direct, surface, and ground wave communications of all frequencies.

The ionosphere is a region of ionized (electrically charged) gasses located approximately 50-600 kilometers (km) above the earth's surface. As illustrated in Table 3, there are essentially four layers (D, E, F1, and F2) of the ionosphere which affect communications and DF. These layers vary in ionization and height above the earth's surface, depending on the amount of exposure to the sun.

The ionosphere is formed when extreme ultraviolet light from the sun strips the electrons from neutral atoms in the ionosphere. Thus, the electrons become free (unbound), and the remaining atom becomes positively ionized. The free electrons reflect/refract radio waves of a certain frequency. Due to this process, the E and F layers become positively ionized.

However, the free electrons may attach to neutral atoms. When such attachments occur, the atoms become negatively ionized. This process is common in the D layer, making the region of the ionosphere negatively ionized. Factors which influence the ionosphere and its effect on radio waves include--

- The time of day.
- The seasons of the year.
- Solar flares.
- Magnetic storms.
- Certain man-made disturbances such as nuclear detonations.

An important relationship between radio waves and the ionosphere is that the higher the frequency, the less its tendency to bend. Depending upon ionospheric conditions and the angle of the signal's arrival at the ionosphere, the bending may be slight. The radio waves may not be sent back to earth (Figure 1-6).

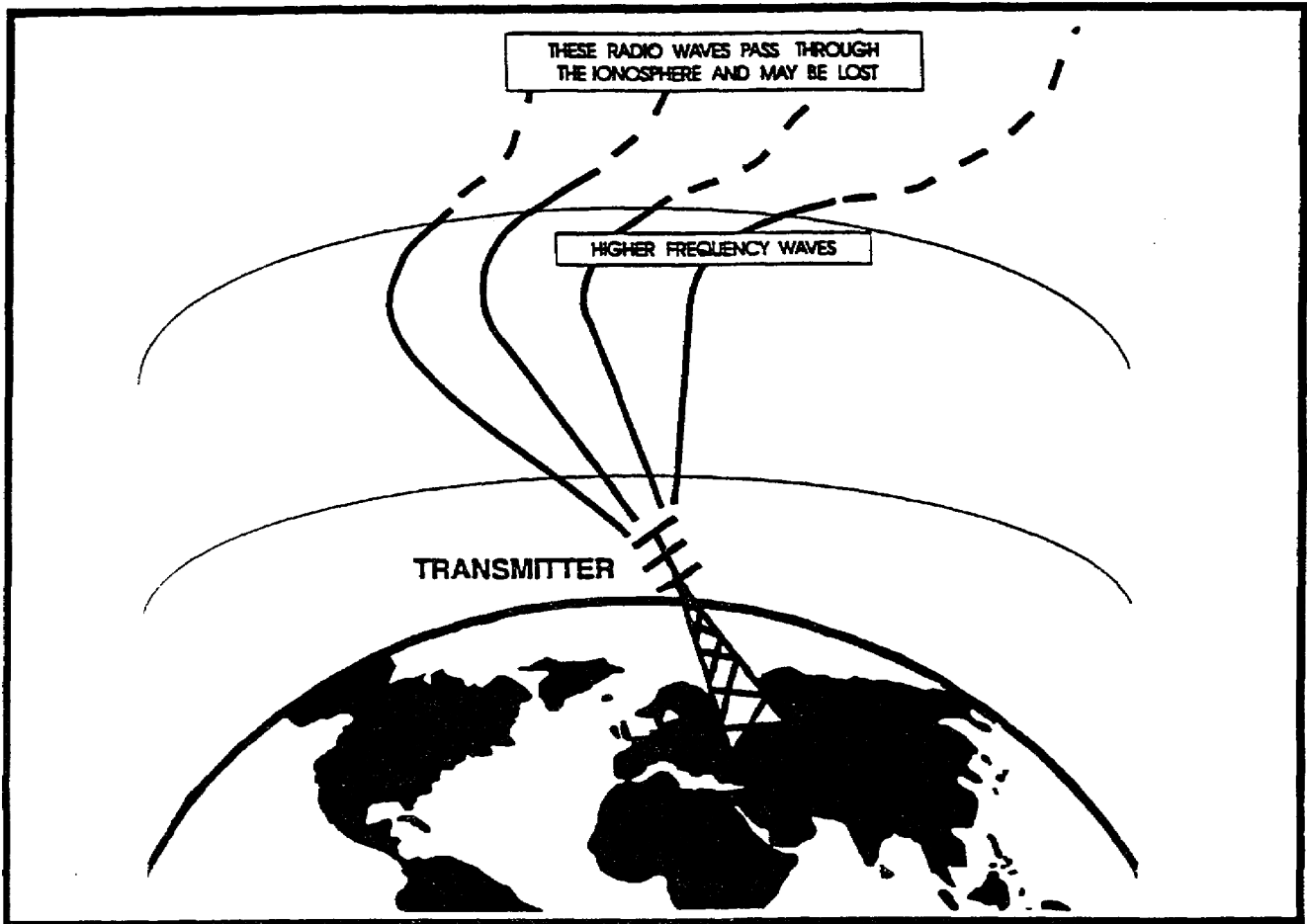

Figure 1-6. High frequency wave penetration.

During daylight hours, the ionosphere is subject to full ultraviolet output from the sun. Therefore, the D, E, F1, and F2 layers reach their full potential. At night, the composition of the layers of the ionosphere changes as the F layers combine. Therefore, higher radio frequencies are more likely to penetrate the ionosphere and be lost. As a general rule, lower communication frequencies are used during the night.

Conversely, during the day when ionization of the atmosphere is more intense, higher communications frequencies can be used without undue loss of the signal. This is because penetration of the ionized layer is at a minimum. Changes in the relative proximity of the sun to the earth will also cause gradual changes in the ionosphere.

Table 3. Characteristics of the ionosphere.

IONOSPHERIC REGION	LOCATION (Km)	FEATURES	EFFECT ON COMMUNICATIONS (Radio Frequency)
D	50-100 km	Layer closest to earth. Negatively ionized layer, with relatively little free electrons. Exists during the day.	Primarily acts to absorb radio waves. Small amounts of refraction are possible, but unpredictable.
E	100-200 km	Positively ionized with varying amounts of free electrons. State changes with temperature; angle of the sun, magnetic fields, and time of day. Exists during the day.	Erratic behavior. Sometimes reflects/refracts radio waves in MF, HF, and lower VHF bands.
F	145-400 km (F1-145-200 km) (F2-240-400 km)	Very positively ionized with large amounts of free electrons. During the day, this region separates into the F1 and F2 layers. The F region decreases in ionization and increases in altitude at night.	Primary means of reflecting/refracting MF and HF signals in sky wave propagation. At night, behavior becomes slightly erratic, but communications distances are much greater.

The longer exposure of the ionosphere to the sun in the summer causes a greater degree of ionization during the night and day. Therefore, higher frequencies may be used for summer operations.

Remember, however, that the actual number of layers, their heights above the earth, and the relative intensity of ionization present will vary. They vary from hour to hour, from day to day, from month to month, and from year to year.

There are three distinct paths that a radio wave may take to reach the receiving antenna. They are--

- Direct.
- Reflected.
- Refracted.

The direct and reflected paths are shown in Figure 1-7. They are purposely exaggerated to enable the reader to clearly grasp the differences.

The direct path goes directly from the transmitting to the receiving antenna. The reflected path bounces off the ionosphere or the surface of the earth at the same angle at which it arrives and continues to the receiving antenna (angle incidence=angle of arrival). The refracted path is the path caused by the bending of the waves in the same manner light waves are bent when seen through water.

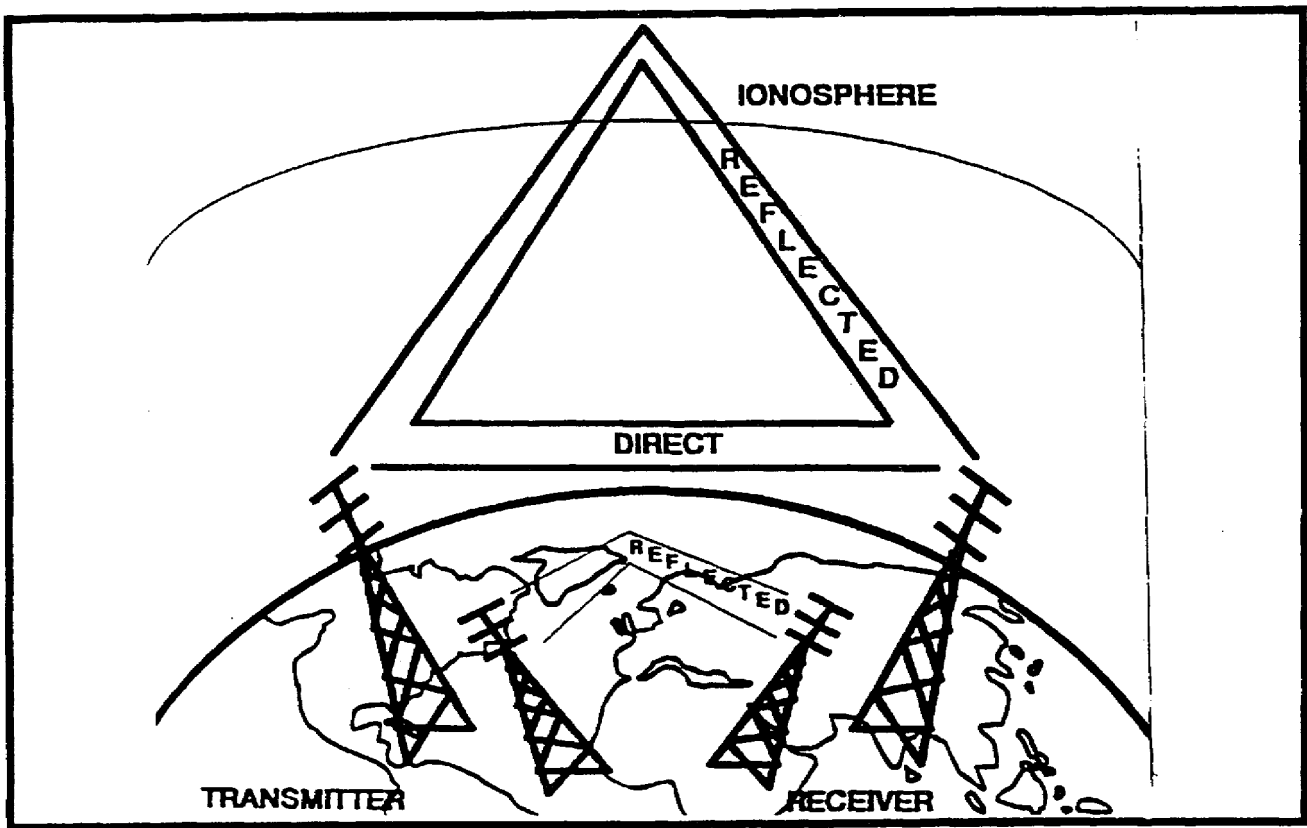

Figure 1-7. Direct and reflected routes for radio waves.

If the waves are refracted by the earth, the distance they travel is severely limited due to large losses of energy in the form of heat dissipated into the earth's crust.

Radio waves may be classified as either ground waves or sky waves (Figure 1-8).

Ground waves are continually in contact with the earth's surface. They do not make use of reflection from the ionosphere. They have a tendency to be refracted and, in some cases, reflected into the lower atmosphere. At frequencies above 1500 kilohertz, a ground wave is affected very little by the time of day or season. The ground wave loses much of its strength and dissipates energy as it travels over the earth's surface. However, less strength is lost when it travels over water.

Sky waves are transmitted upward with respect to the earth's surface. Sky waves would not be useful for communications were it not for the ionosphere. Radio waves approaching the ionosphere at an angle are refracted back to earth. They may be detected and used for communications purposes or for DF exploitation.

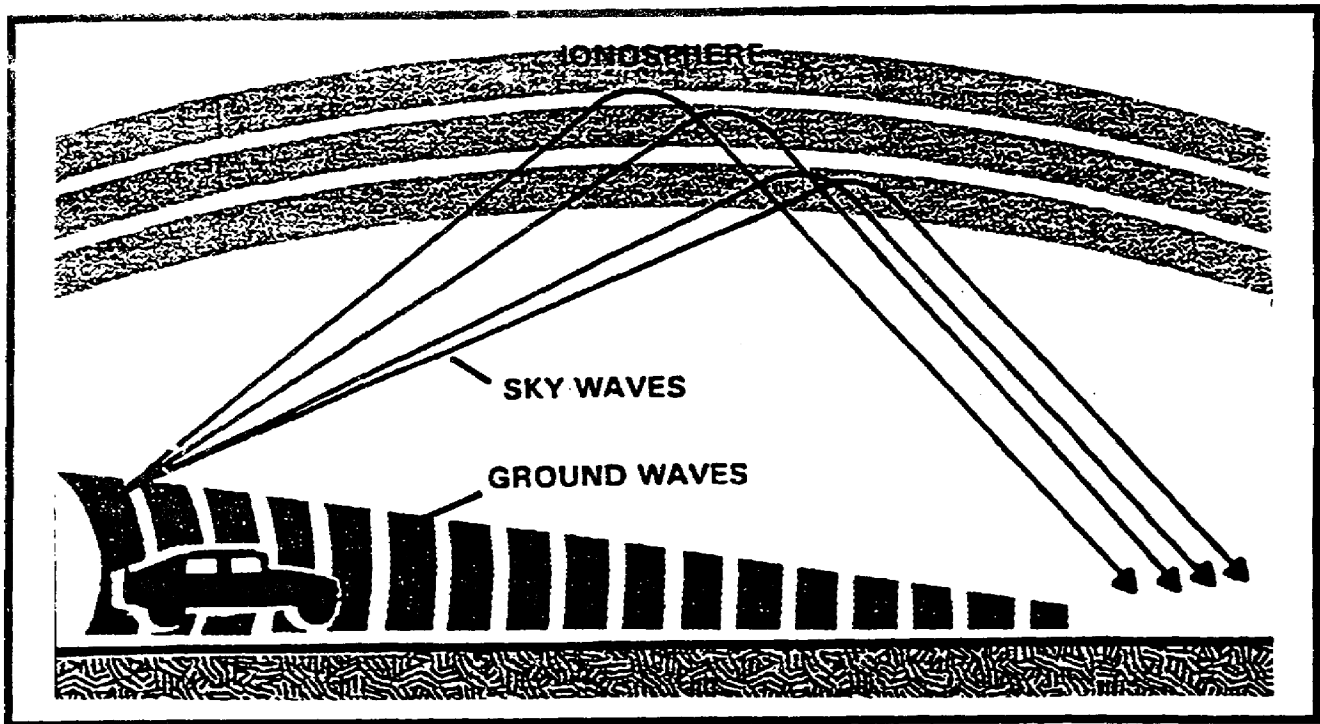

Figure 1-8. Ground waves and sky waves.

The skip zone is the area where the ground wave can no longer be detected (Figure 1-9) and the sky wave has not yet returned to earth after being reflected or refracted off the ionosphere or troposphere. The skip distance is that area where no sky wave reception will be possible. This is because the wave has not returned to earth after its first or subsequent bounce off the reflecting layer.

Depending upon the frequency and the transmitter power, multihop transmissions are routinely used for communications. Figure 1-10 illustrates multihop transmissions. There will be, however, skip zones between the points of the wave's return at each hop. Note, however, skip zones are not static or stable.

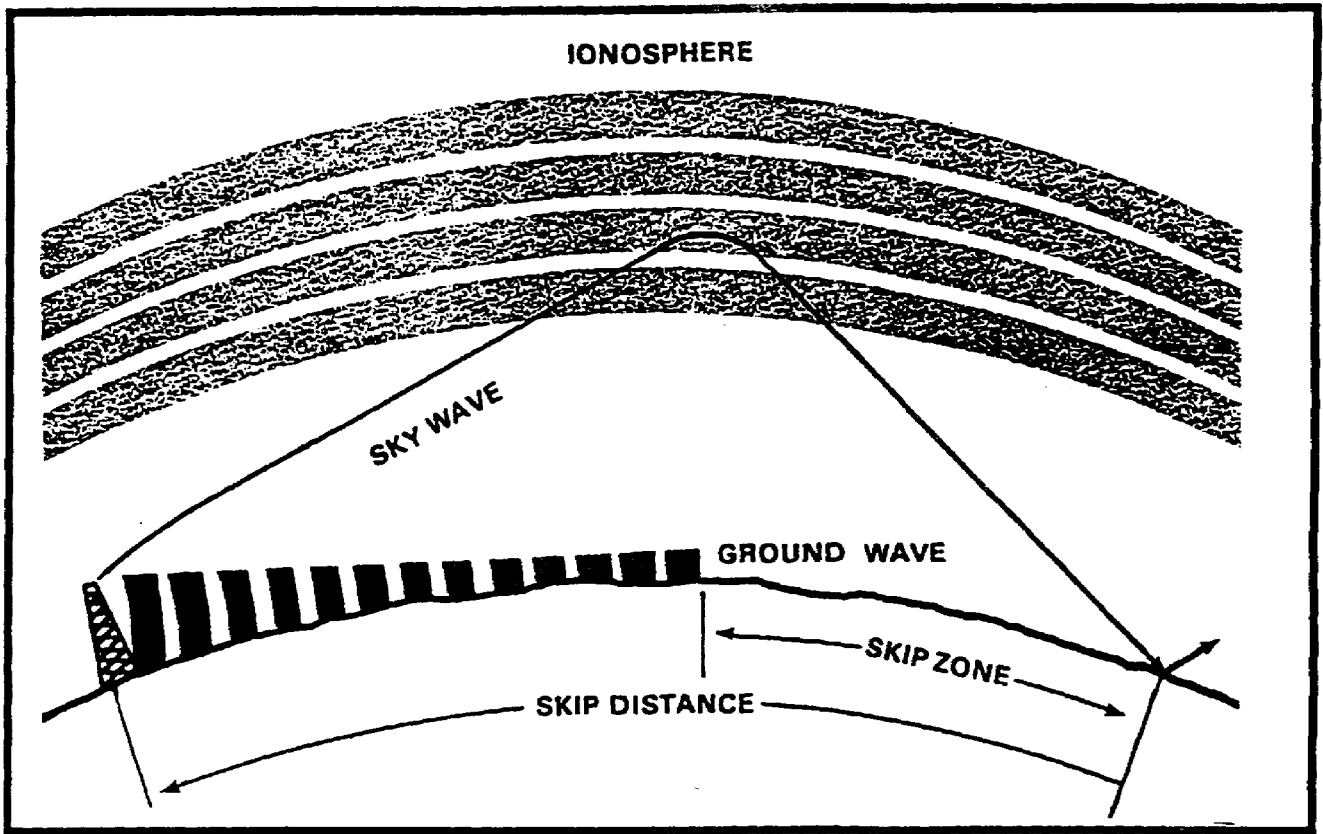

Figure 1-9. Skip zone and distance.

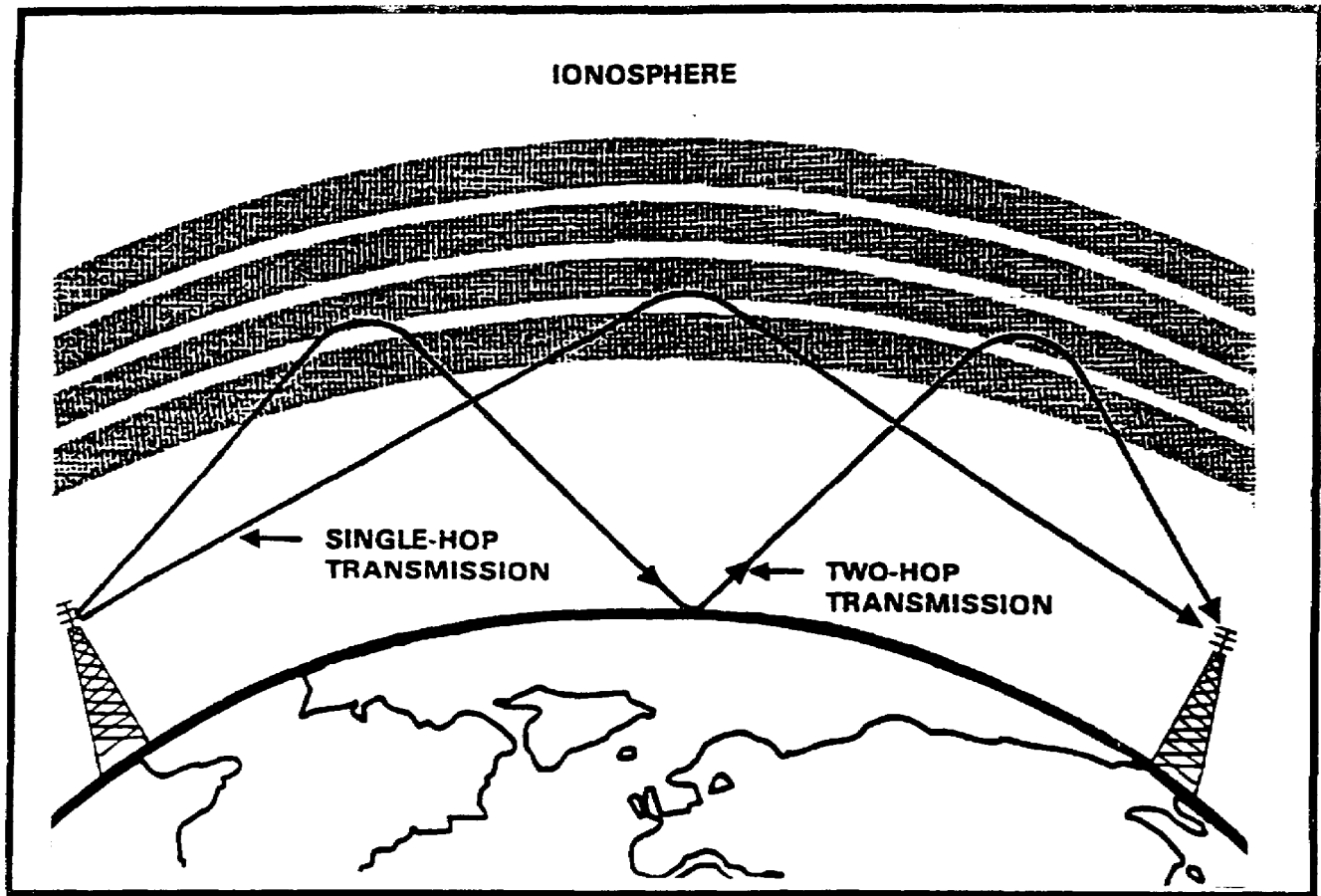

Figure 1-10. Multihop transmission.

PART B: PROPERTIES

Have you ever rotated a portable radio to find the best position to hear the station? If so, you are an experienced radio direction finder. The equipment was not very complex, but it met your requirements to get the results you wanted.

If you had turned the radio on full circle you would have heard two maximum and two minimum volumes. The reason for this is quite simple. The antenna in the portable radio is usually a bar-type antenna which is highly directional.

The pencil can be used to demonstrate the directional properties of the bar antenna. Hold a pencil in front of yourself with the pencil parallel to the ground. (See Figure 1-11).

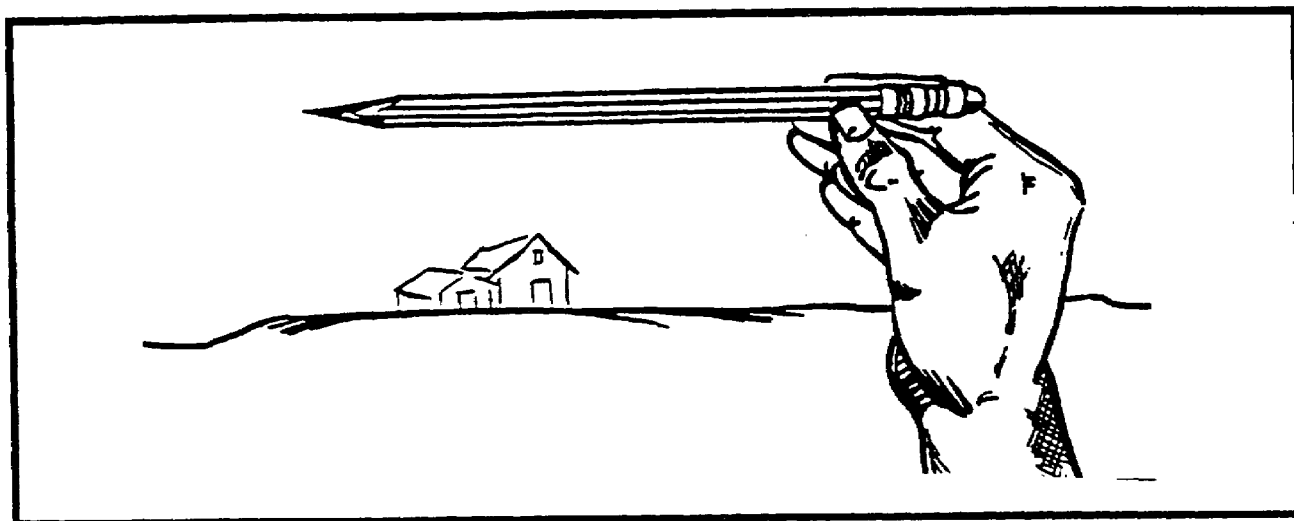

Figure 1-11. Pencil parallel to ground.

Keeping the pencil parallel to the ground, rotate it one full circle. Note that you see each end once and each side once, or put another way, the pencil is sideways to your twice and end on twice. In a bar antenna the sides give maximum reception (signal is loudest) and the ends give minimum reception. The minimum reception points are called NULL points and are important to direction finders because they are easier to hear and locate accurately than are the maximum signals.

The response pattern (a diagram showing the maximum and minimum areas of reception) for a bar antenna is a figure eight. The diagram in figure 1-12 indicates that the end points of the bar receive almost no signal, while the sides receive maximum signal. Since we are using our ears as aural indicators for signal reception, and since a minimum signal or NULL is easier to locate accurately than a maximum signal, we would use aural null indication to locate the transmitter. Of course the problem for a portable radio is locating the best reception rather than the least, but the principle is the same.

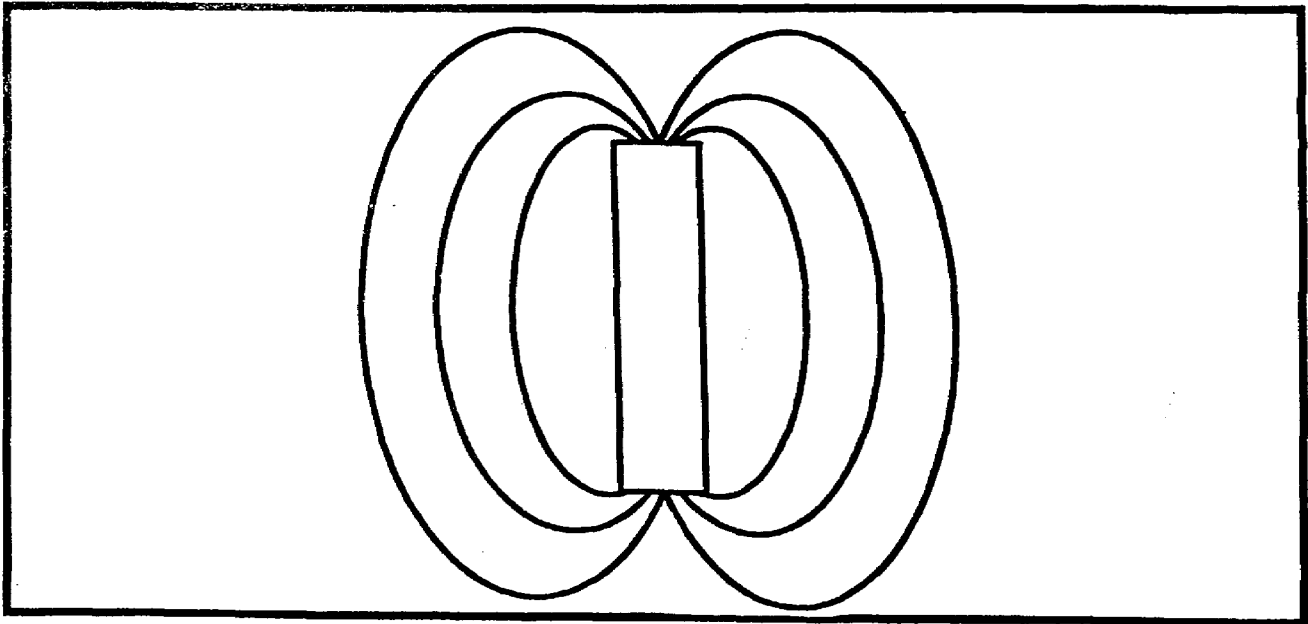

Figure 1-12. Response pattern for a bar antenna.

If we had some sort of compass or direction indicator on the radio we would have a complete direction finder. There is one other factor to be considered. We have two possible directions to choose from. This is the bidirectional ambiguity (the hard way to say it)(See Figure 1-13) which must be resolved (you must make a choice) for accurate direction finding. To do this we must add the signal input of another antenna (sense antenna) to the directional antenna giving us a cardioid (heart-shaped) pattern. This takes away one of the nulls, allowing us to decide which direction to choose. (See Figure 1-14).

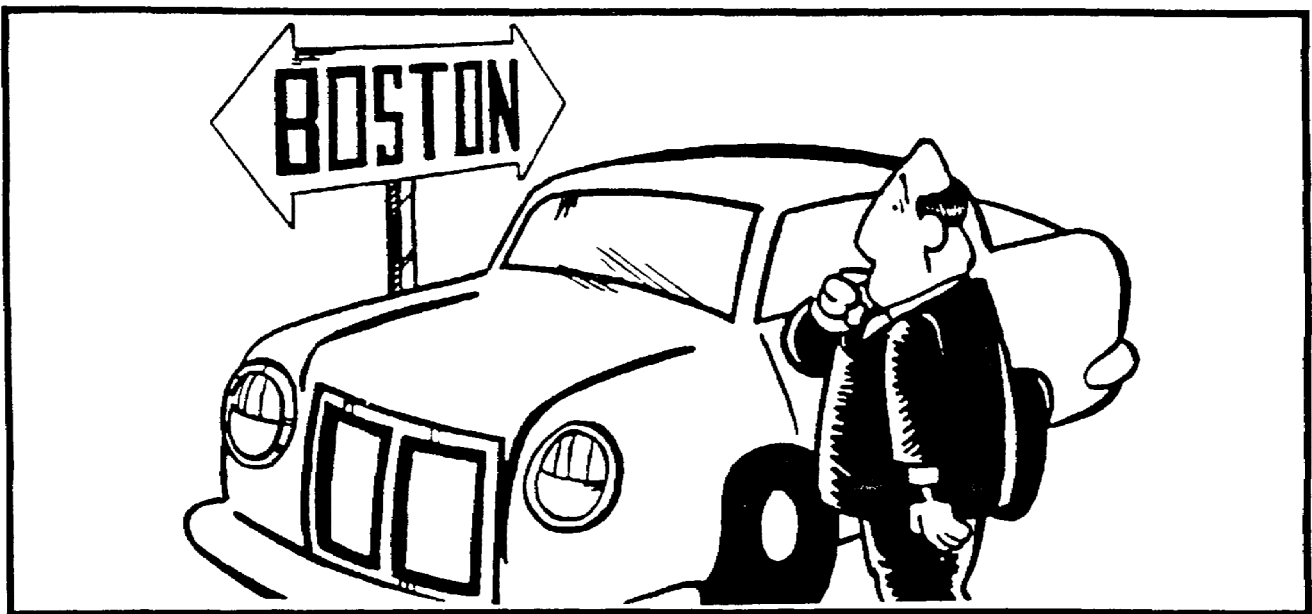

Figure 1-13. Example of bidirectional ambiguity.

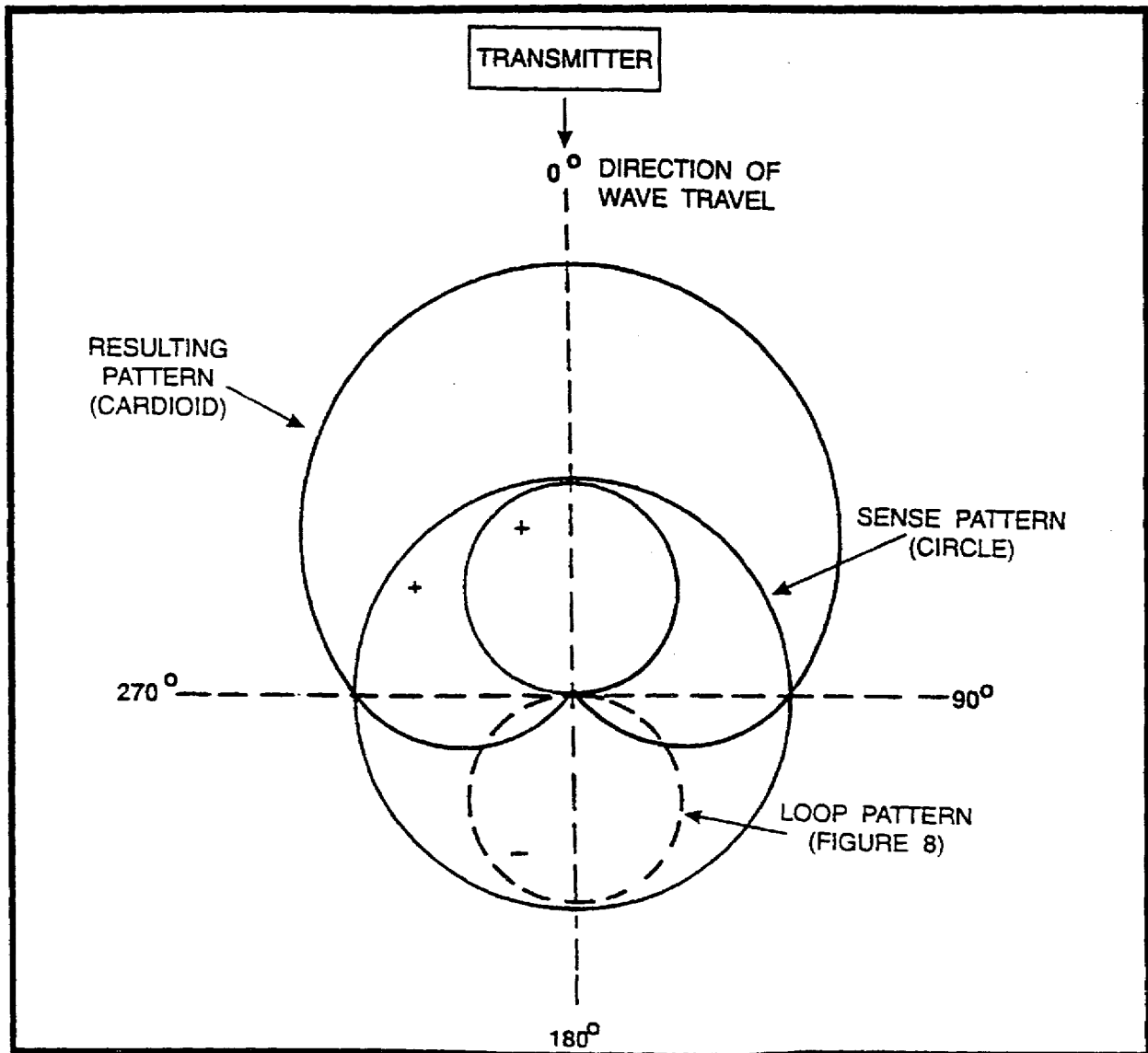

Figure 1-14. Combination of sense and directional antennas.

With the continual development of minicomputers and microprocessors, other methods of direction finding have become feasible. One common method of azimuth determination is Time of Arrival measurements. For this measurement, at least two antennas are used to form an antenna baseline. (See Figure 1-15).

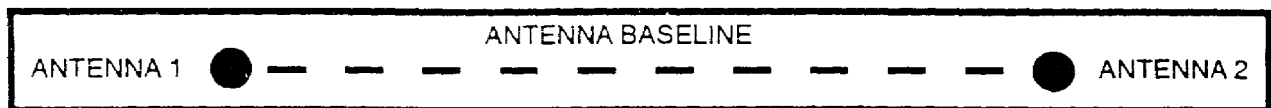

Figure 1-15. Antenna baseline.

As the wavefront strikes each antenna, a microprocessor measures the difference in the time of arrival at each antenna, and the angle of arrival is determined. (See Figure 1-16).

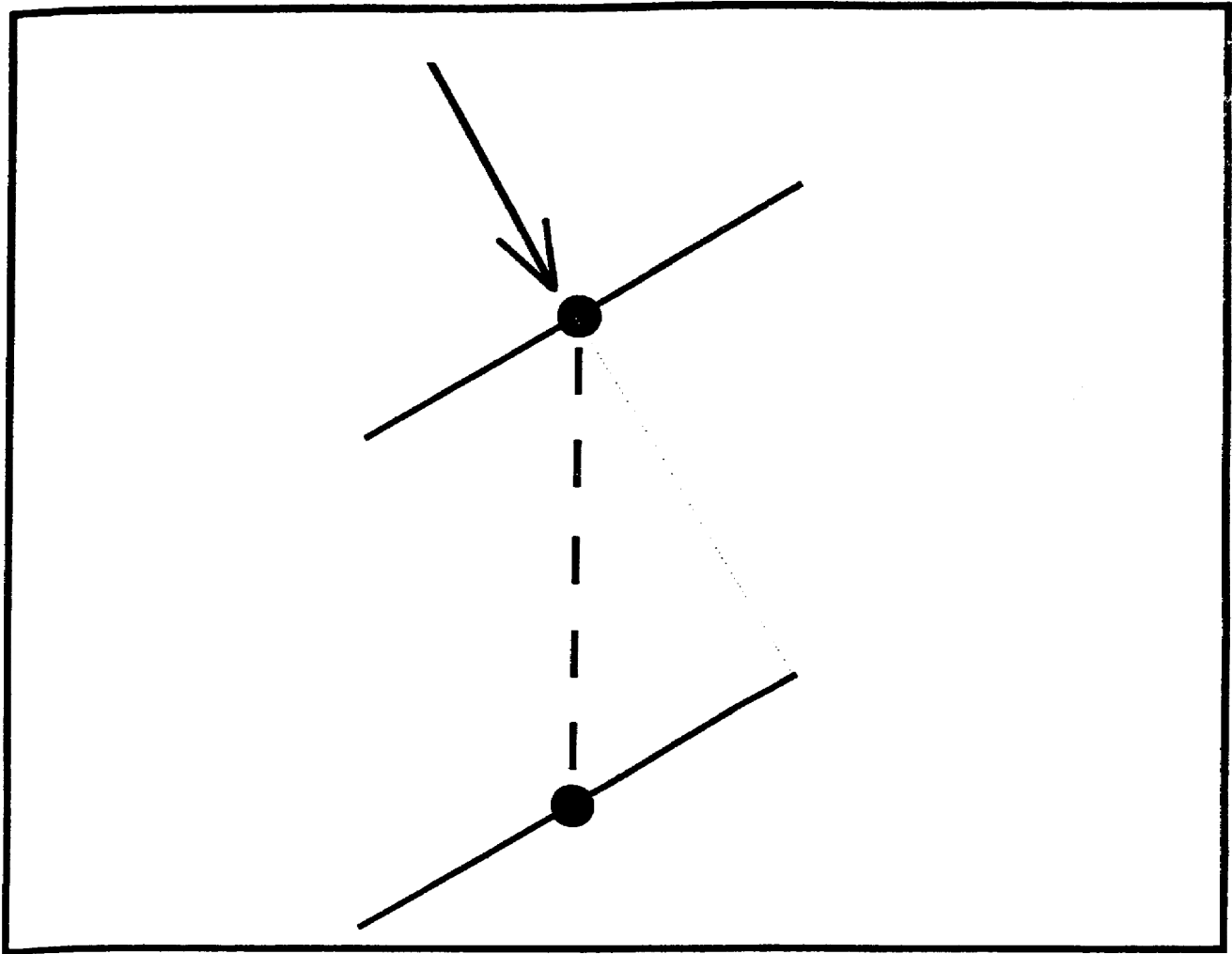

Figure 1-16. Angle of arrival.

As with the bar antenna, however, a possibility of bidirectional ambiguity exists with time of arrival measurements if the wavefront strikes both antennas at the same time. (See Figure 1-17).

To resolve this ambiguity, at least one more antenna is added to form one or more added baselines. (See Figure 1-18).

If a wavefront strikes antennas 1 and 2 at the same time, the ambiguity is resolved by measuring the time difference of arrival of the wavefront at antenna 3.

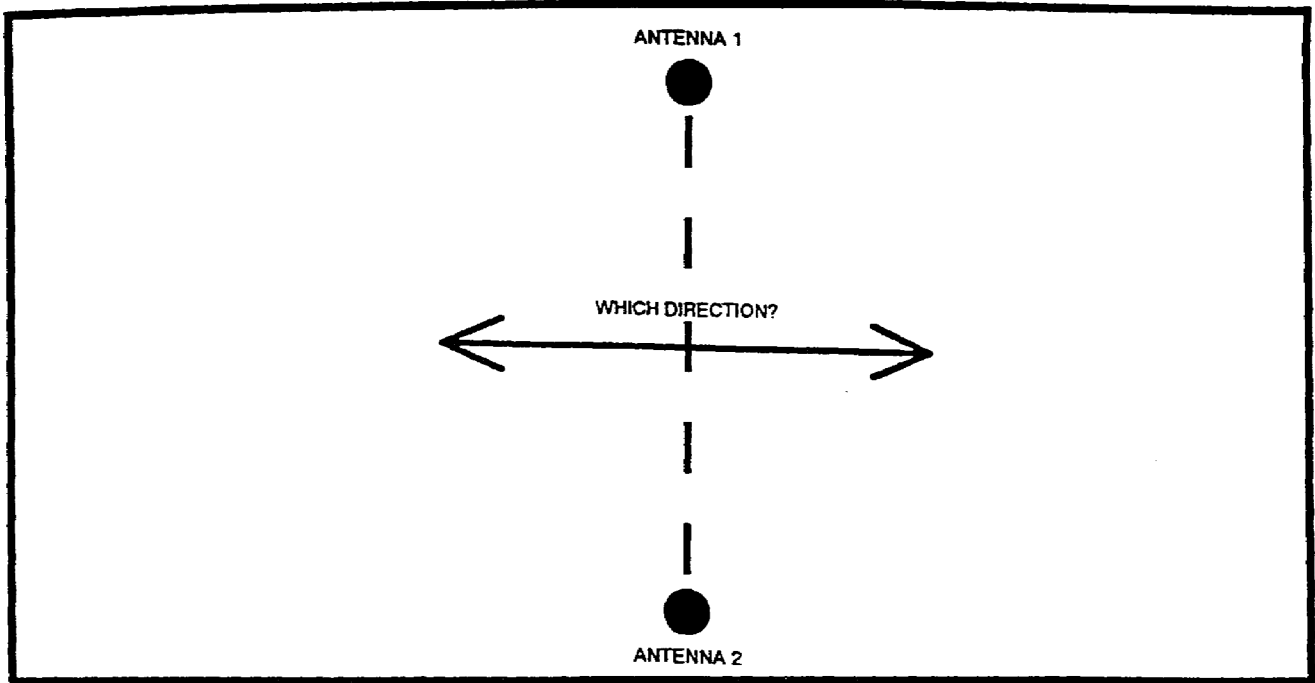

Figure 1-17. Bidirectional ambiguity.

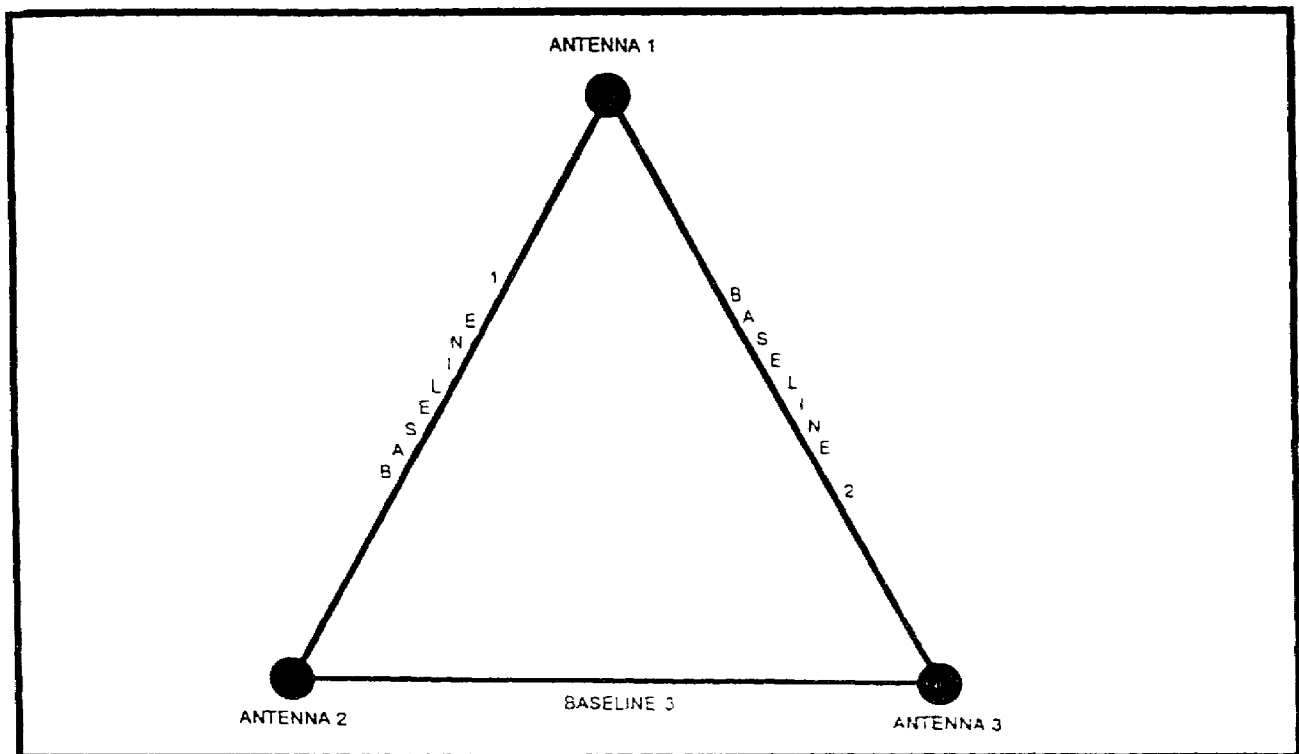

Figure 1-18. Antenna Baseline.

PART C: Elements

This is the basic theory of direction finding and the principle under which most direction finding is "determining the horizontal angle of arrival of a radio wave with respect to a known reference." The known reference is usually True North for strategic systems or Grid North for tactical systems. The horizontal angle is specified because other radio problems involve the vertical angle of arrival (how far to tilt the antenna for best reception) and arrival is specified because we want to know where it is coming from, not where it is going.

The determination of the azimuth is made by determining the angle of arrival, then measuring the angle between the point of arrival and the reference. This is called the azimuth or line of bearing (LOB) and has many applications. It can tell the operator the approximate direction to a transmitting antenna. If the direction finder is placed on a ship or aircraft, the vessel can "home in" on the transmitter. (See Figure 1-19).

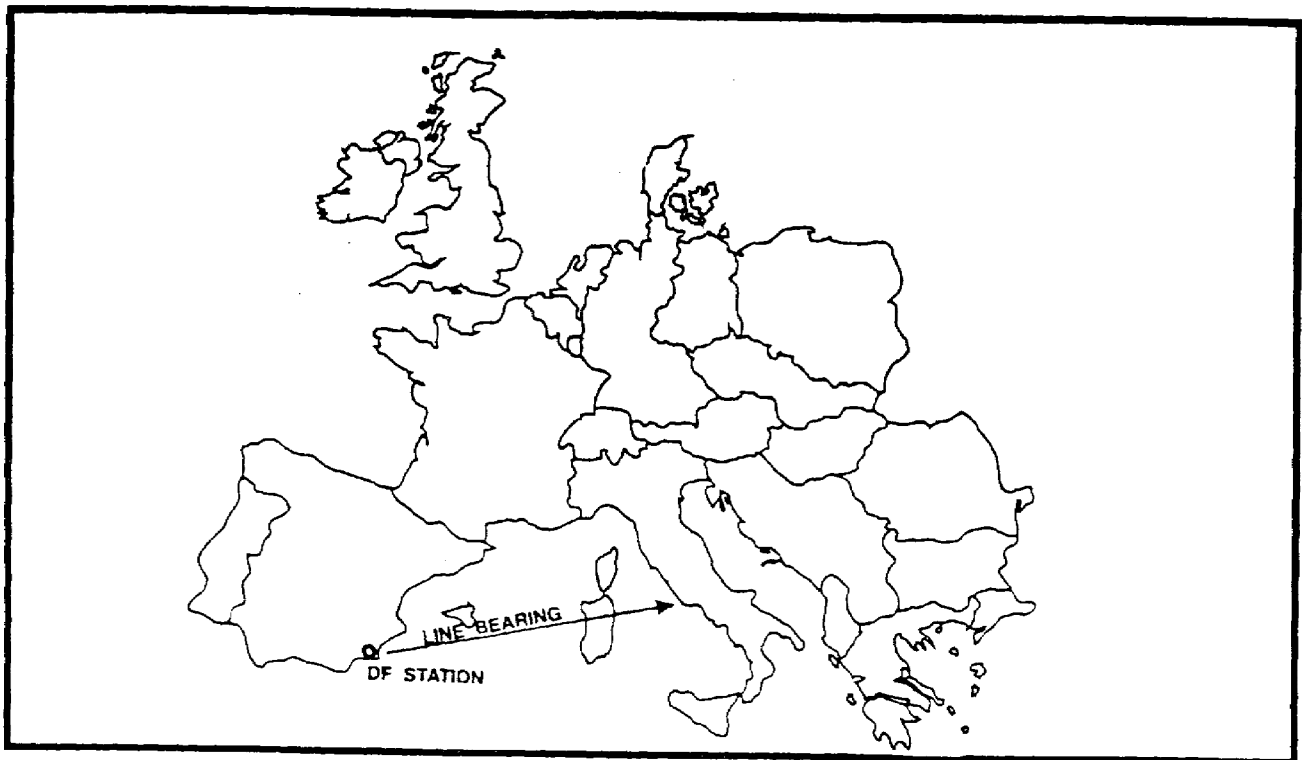

Figure 1-19. DF station line of bearing.

If we use two direction finders and take bearings with both at the same time we can locate a transmitting antenna with limited accuracy. The intersection of two azimuths is called a CUT and will provide the general location of the transmitting antenna. (See Figure 1-20).

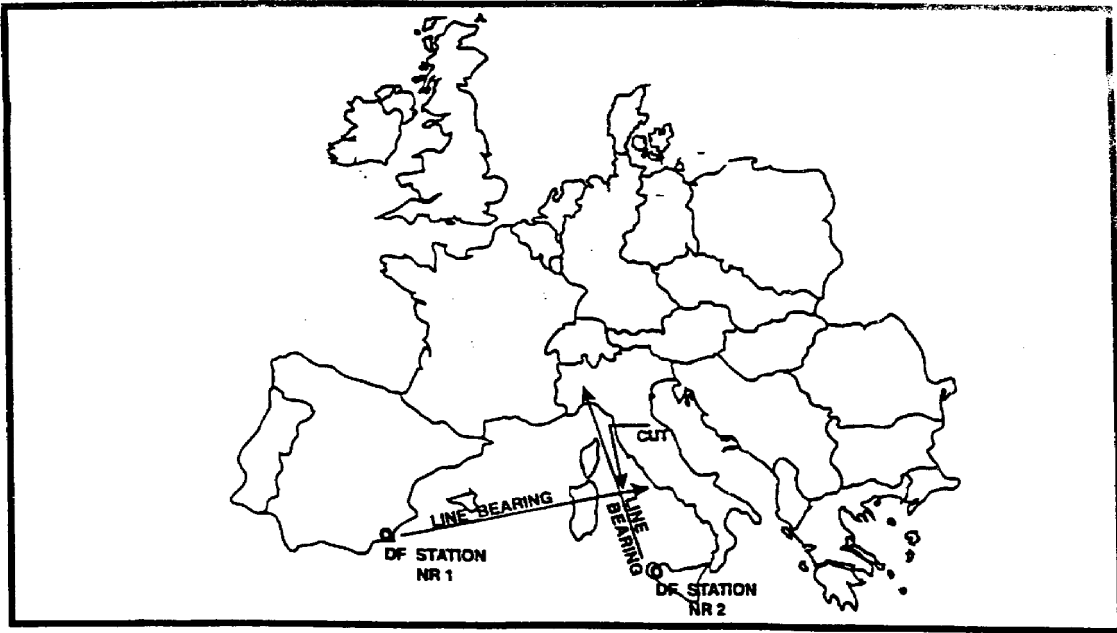

Figure 1-20. Cut of 2 DF stations.

For better accuracy in locating a transmitting antenna we must have three or more direction finders taking simultaneous bearings. This is termed a FIX, or FIX AREA, and will provide the probable location of the transmitting antenna. (See Figure 1-21).

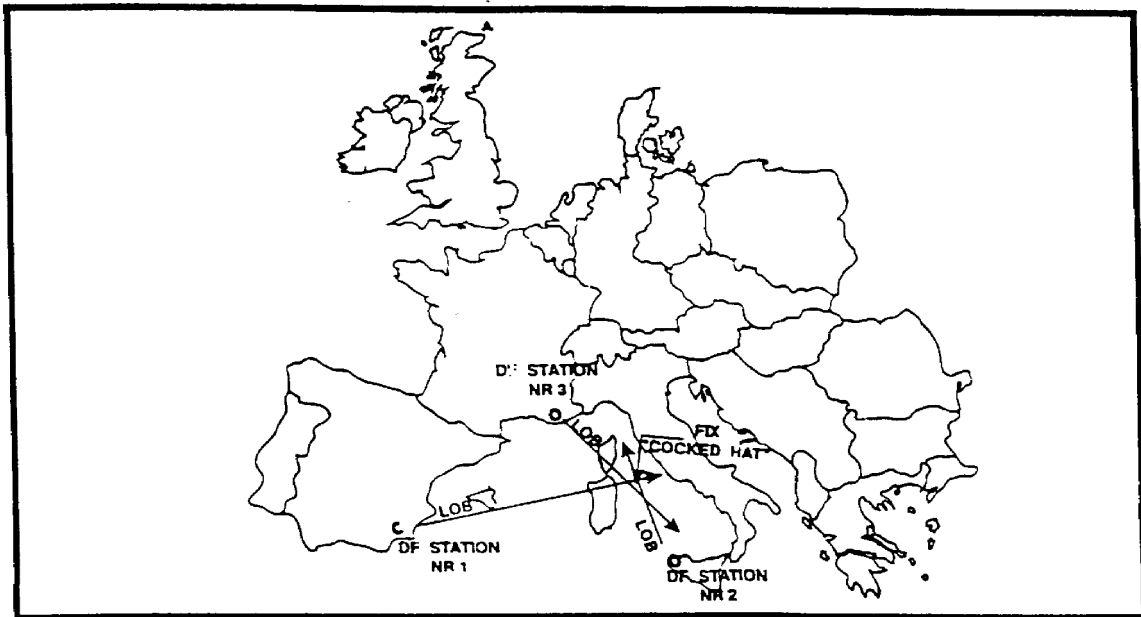

Figure 1-21. Fix area of 3 DF stations.

Note that we use the terms "approximate direction", "general location", and "probable location." This is necessary because of the many variables that affect direction finding. Your studies of radio wave propagation will find many causes of inaccuracies in direction finding. The most

accurate direction-finding equipment in use today has an equipment error of plus (+) or minus (-) 1 degree. This means that if there were no propagation errors to contend with, the equipment itself might cause an error of over 17 miles at a distance of 1000 miles. This problem of errors is taken up more fully in another course.

To be effective, direction finders must have access to listening posts or intercept stations, and must be tied together with a reliable high-speed communications system, and they must be carefully placed in well-planned locations. The spacing of these locations results in a BASELINE, which is important in respect to direction-finding net capabilities. The listening post will monitor several frequencies, and when a transmitter is heard, the direction finders will be notified using the communications system. If the direction finders are placed on a well-planned baseline they will be able to locate the transmitting antenna with a fairly high degree of accuracy. The baseline must be arranged so that the intersection of the bearings for a target located in the approximate center of the area of interest, will be close to 90 degree angles.

The azimuth from each direction finder is plotted on a map, the resultant enclosed area probably includes the location of the transmitting antenna. (See Figure 1-22).

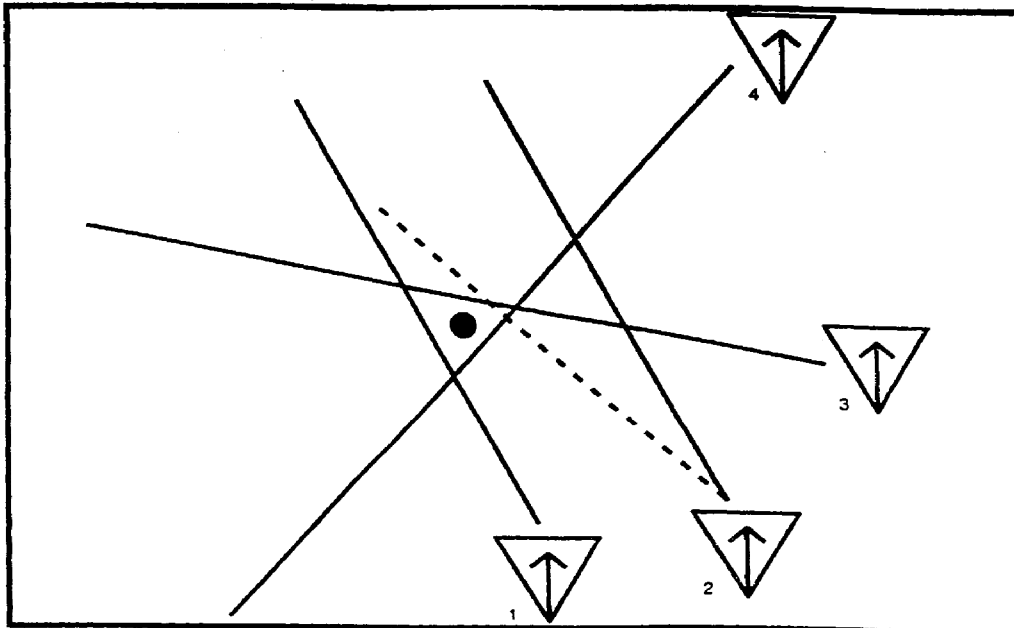

Figure 1-22. Plotted probable location.

The Chiefs of Staff of the Army and Navy have implemented a Joint Air-Sea Rescue Communication Plan (Joint Emergency Rescue Communication Plan JANY-10) which prescribes the procedure to be followed in establishing contact with shore DF stations. The services maintain high frequency DF networks along the various air routes. providing aids "fixes" to aircraft.

An evaluation center is associated with each DF network for the purpose of furnishing fixes and other navigational information to operations offices.

Radio direction-finding devices are used by ground force units for homing or positioning of patrols and reconnaissance units. Airborne troops also use these devices to regroup after landing. In many cases these devices are not complete DF units but simple devices attached to a common field radio receiver. DF is used to locate enemy aircraft in flight, ground control stations, and radio navigational aids. The results of DF correlated with other information comprise one of the most important sources of combat intelligence from which it is possible to determine the enemy order of battle when there is no physical contact. This information is usually more comprehensive than that derived from enemy radio stations. These stations are then monitored by DF for possible movement.

As demonstrated earlier, there are many types of direction finding systems. In some, only the azimuth of the arrival angle can be measured. In others, the azimuth and the elevation angle can be obtained. When only an azimuth is resolved, two or more independent DF stations are needed to determine the location of the transmitting antenna. Systems that measure both azimuth and elevation angles are called **single station locator** (SSL) systems. The SSL was developed because of the problems of audibility with the traditional DF network. Sometimes the signal could only be heard at one DF site.

The SSL system direction finder is a phase measuring interferometer. Location data include an azimuth measure on the target signal and a range estimate based on the measured parameters at the DF site. The combination of azimuth and great circle range to the target produces the location output from the system's computer.

Because the SSL system depends on ionospheric propagations, it is designed for use against the high frequency (HF) spectrum sky wave transmissions. As shown in Figure 1-23, the combination of an azimuth and great circle range to the target produces a location from the system that is expressed in geographic coordinates.

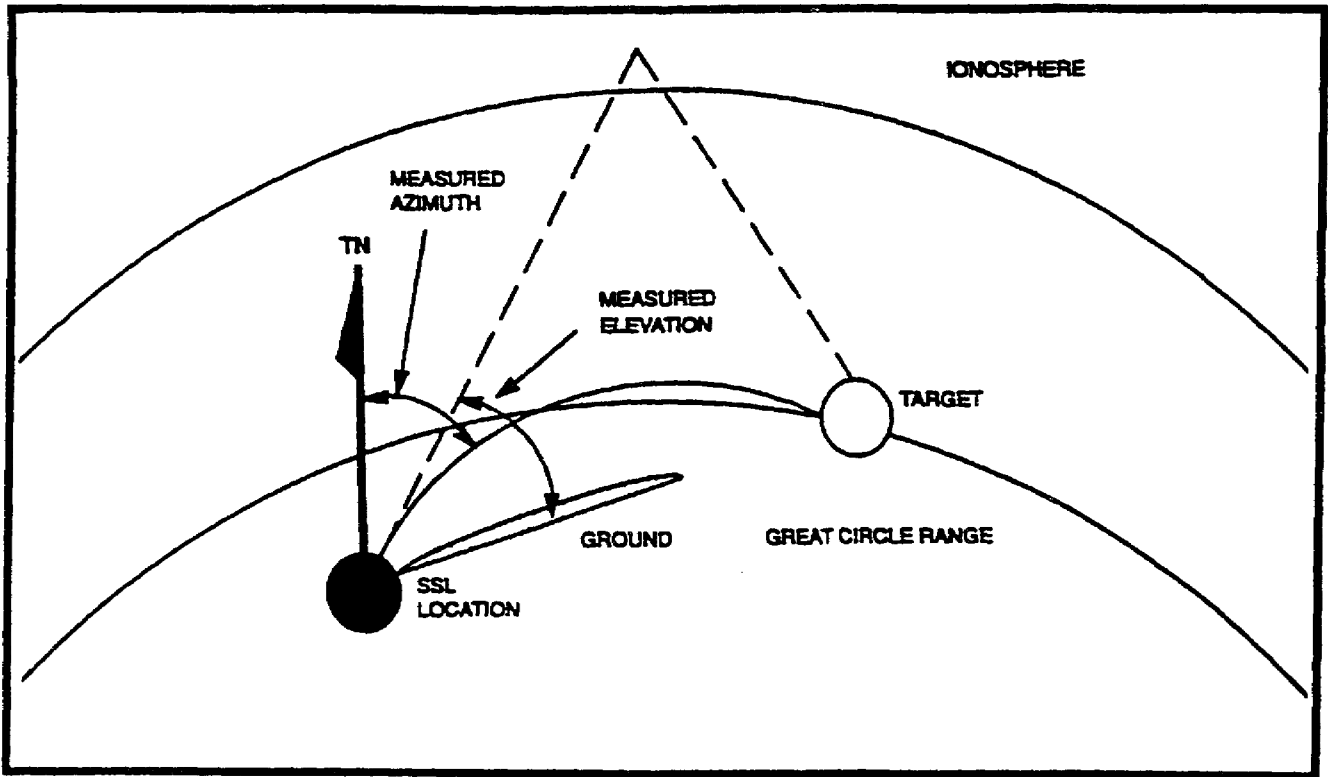

Figure 1-23. Single station locator DF.

LESSON 1

PRACTICE EXERCISE

The following items will test your grasp of the material covered in this lesson. There is only one correct answer for each item. When you have completed the exercise, check your answers with the answer key that follows. If you answer any item incorrectly, study again that part of the lesson which contains the portion involved.

1. What is a radio waves strength or intensity called?
 - A. Consecutive Cycles
 - B. Complete Wavelength
 - C. Its Magnitude
 - D. Its Amplitude

2. What does DF determine the direction of?
 - A. Artillery Fire
 - B. The arrival of a radio wave
 - C. The direction a radio should be pointed for the best reception
 - D. The distance of a receiver

3. What band designator would the frequency 200 MHz be in?
 - A. HF
 - B. VHF
 - C. UHF
 - D. SHF

4. What are the DF results with a range of 1000 miles called?
 - A. Approximations
 - B. Exact, if enough sites are used
 - C. Reliable
 - D. An indicator of general direction only

5. Which of the following is NOT used as a military application of DF?
 - A. Positioning of ground forces
 - B. Determining order of battle
 - C. Location of communications systems
 - D. Detection of chemical agents

6. What is the most common reference point for DF?
 - A. The enemy front
 - B. The friendly forces front
 - C. Magnetic north
 - D. True north or grid north

7. Which frequencies would you use for the best communications at night?
 - A. Lower Frequencies
 - B. Mid-range Frequencies
 - C. Higher Frequencies
 - D. Ultra High Frequencies

8. What is the accuracy of the most accurate DF equipment used today?
 - A. +1%
 - B. + 2%
 - C. + 1 degree
 - D. + 2 degrees

9. What is the term used for the intersection of two azimuths?
 - A. Bidirectional
 - B. LOB
 - C. Cut
 - D. Fix Area

10. Including an azimuth, what is also measured by a SSL system in order to determine the location of a transmitting antenna?
 - A. Elevation Angle
 - B. Ground Waves
 - C. Target Area
 - D. Skip-Zone

LESSON 1

PRACTICE EXERCISE

ANSWER KEY AND FEEDBACK

<u>Item</u>	<u>Correct Answer and Feedback</u>
1.	D. (page 1-2)
2.	B. (page 1-1)
3.	B. (page 1-3)
4.	A. (page 1-19)
5.	D. (page 1-21)
6.	D. (page 1-18)
7.	A. (page 1-7)
8.	C. (page 1-20)
9.	C. (page 1-18)
10.	A. (page 1-21)

LESSON 2

EQUIPMENT REQUIREMENTS

CRITICAL TASK: None

OVERVIEW

LESSON DESCRIPTION:

In this lesson you will learn to identify the basic equipment requirements for a radio direction finding system and certain concepts needed for discussion of direction finding equipment.

TERMINAL LEARNING OBJECTIVE:

- TASK:** Identify the basic equipment requirements for a radio direction finding system and certain concepts needed for discussion of direction finding equipment.
- CONDITION:** You will use the information provided in this subcourse.
- STANDARD:** To demonstrate competency of this task, you must achieve a minimum of 70 percent on the subcourse examination.
- REFERENCES:** The material contained in this lesson was derived from the following publications:
- FM 11-64
 - FM 11-666
 - FM 30-476
 - FM 34-40-9(U)
 - FM 34-86

INTRODUCTION

Radio direction finding equipment comes in all sizes and shapes, depending upon the requirements of the users. Some equipment can be hand-held, back-packed, or airborne (Figure 2-1) while other configurations require several acres of land for installations.

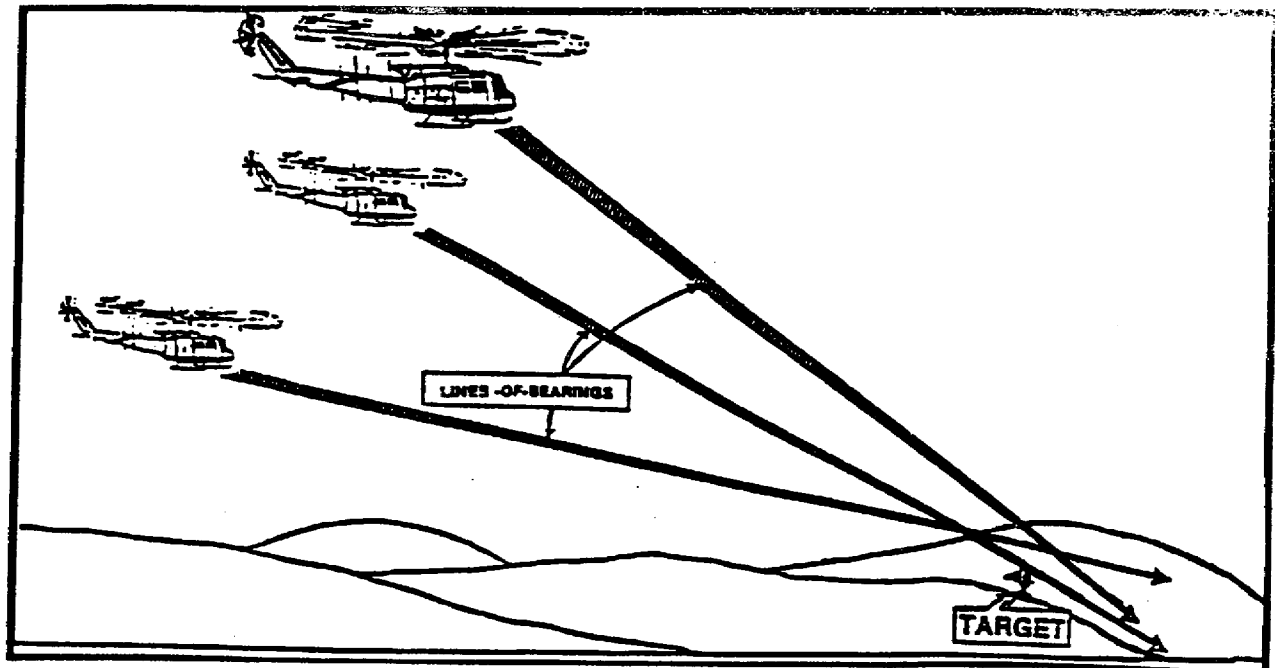

Figure 2-1. Airborne radio direction finding.

PART A: COMPONENTS

Regardless of the requirement, direction finding equipment will have the same basic components. (See Figure 2-2).

- a directional antenna
- a radio receiver
- a coupling system
- a method of indication

Suppose we refer to the portable radio mentioned in the first lesson. The directional antenna is the bar antenna. The receiver is the radio itself. The coupling system is the "direct coupling." The indication system is the "aural null." Each is designed for the specific job it is supposed to do, and is the most efficient piece of equipment the manufacturer can use within the parameters (requirements) needed. Probably the first consideration for the manufacturer was cost efficiency, second was size and weight. Third was ease of use. Fourth was neatness of design. There are others but our discussion will stop here.

The Directional Antenna. The bar antenna is the most compact for the frequency range of the receiver. It is highly efficient and relatively inexpensive, consisting of a number of turns of wire wound around a core. The fact that it is bidirectional was of secondary importance to the manufacturer, but it makes a net illustration for the DF student. Of course, the user of the radio is more interested in the peak reception than the null, but still the directivity is there and can be used. As an illustration of the case of use of the null, as compared to the maximum point, try lining yourself with the length of the antenna as compared with centering yourself on the width.

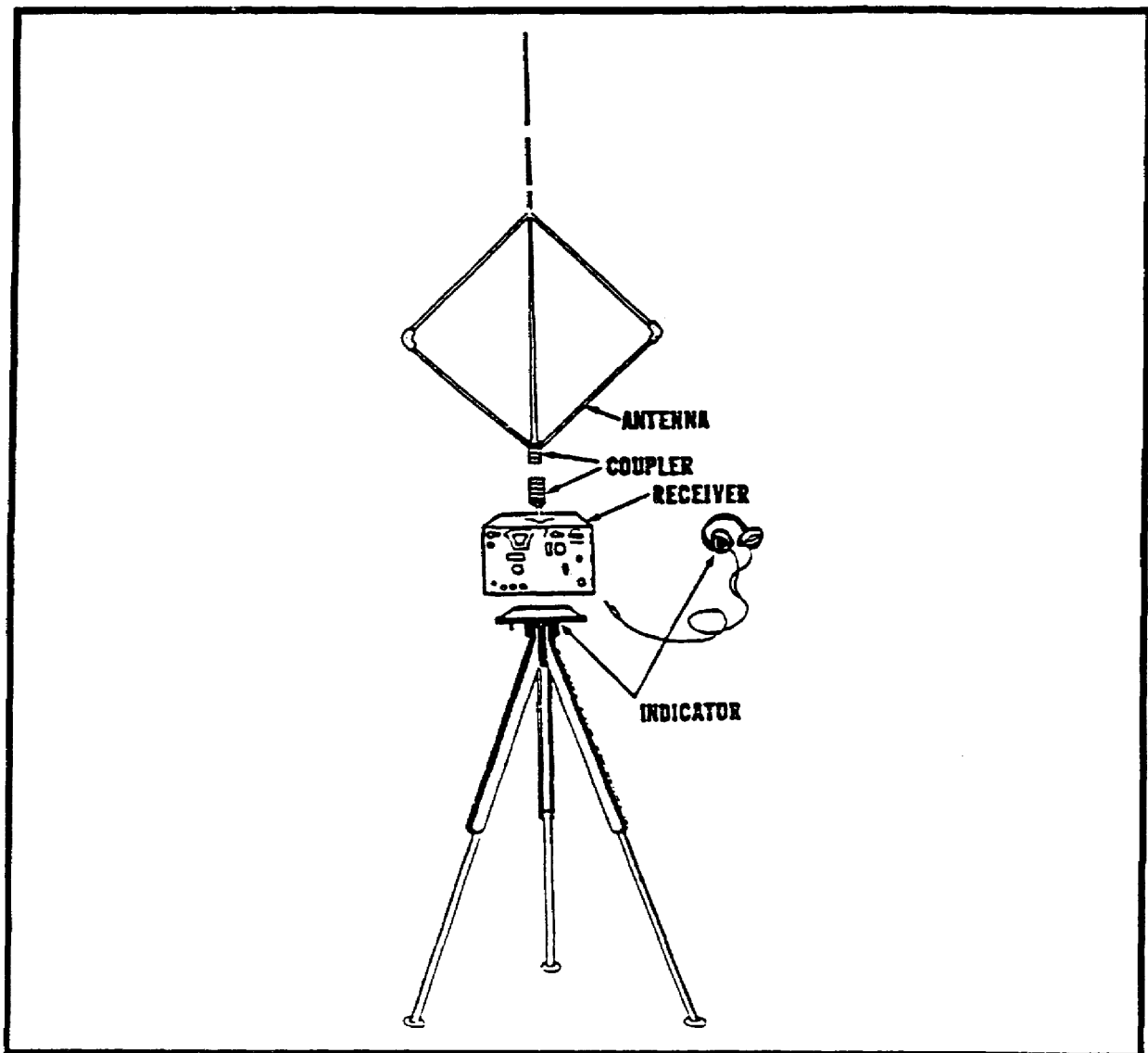

Figure 2-2. Basic components.

Or, put another way, if you hold a pencil you can tell where the point is by looking, but where is the exact middle of either side?

The coupling system. This is the device that connects the antenna to the receiver. The directional antenna must be rotated in a circle to detect the angle of arrival of the radio wave. If we were to use a simple antenna cable, it would soon twist until it broke. Several systems have been devised but all can be identified as either manual or electronic. The simplest system is the direct coupling in your portable radio. The problem is that it requires us to rotate the receiver as well as the antenna to determine the angle of arrival. This would be difficult with our large systems. Another manual coupling is slip ring and brushes. This is an antenna which is rotatable but maintains contact by means of brushes (such as in the generator of your car touching slip rings which allows the signal voltage to pass freely from the antenna to the receiver). For direction finding antennas that are too large to be normally rotated, a device

called a goniometer is used to electrically rotate the antenna. The leads from the antenna are connected to coils in the goniometer, and another coil is rotated in order to sample each portion of the circle in turn. Some of our VHF/UHF DF systems use a microprocessor or minicomputer to electronically measure the time of arrival instead of rotating the antenna.

The Radio Receiver. Your portable radio, whether it be a small Amplitude Modulated (AM) receiver or the larger, and costlier, transoceanic AM, Frequency Modulated (FM) shortwave type, is designed to receive broadcasts within certain wavelength imitations. These limits are called the frequency range of the receiver. Which receiver will be used with your DF system depends upon the frequency range of the transmitter in which you are interested. Another consideration is the desired mobility (how fast it can be moved without damage) and transportability (what does it take to move it) of the DF system. The DF receiver must have good stability (stays on frequency), sensitivity (you can hear and target), selectivity (you can tune out the signals you don't want), and a Beat Frequency Oscillator (BFO) which is used to give a steady tone for ease of direction finding/AM signals.

The input and output circuits of an ordinary communications receiver usually require modification for use with direction finders. The portable radio, for example, has the correct frequency range for the targets desired. It is designed to be hand carried, relatively stable, has selectivity, and is as sensitive as the price allows. It does not have a BFO, therefore, it does not meet our requirements. If we were to use it with our systems we would have to add a BFO.

The Method of Indication. By now you are familiar with aural null indication. The most common system other than aural null is visual indication. This employs a cathode ray tube or some type of meter which indicates the null or maximum signal for your interpretation. The indicator is usually associated with some sort of a measuring device so the operator can record what he/she sees or hears.

A useful direction-finding system must have these four components. The targets, and the tactical situation will indicate what combination and size of equipment can or should be used.

PART B: DEFINITIONS

Many of the terms used in discussing direction finding are unique to direction finding or are used in a different sense. In order to understand how these terms relate to the discussion that follows, you will need to know exactly what is meant by each of them. These terms relate primarily to a discussion of antenna theory.

(a) Loop. Originally a loop antenna was a circle of wire. Modern loops come in a variety of shapes but essentially and electrically they are the same as the original circle. It might be easier to think of the circle as a square, with vertical and horizontal sides, since the action of the radio wave on the antenna is discussed in terms of how it affects the horizontal and vertical members of the loop.

(b) Conductor. The wire or similar material used to pass current from one part of a circuit to another.

(c) Instantaneous voltage. The amount of voltage present at any given instant in an electric circuit. Differences in instantaneous voltages, or the lack of differences, give an antenna its directivity.

(d) Magnitude. How big, or small, strong, or weak, something is. For our purposes magnitude refers to the strength of an electric or magnetic field.

(e) Plane parallel to the wavefront. This concept is the biggest single stumbling block to discussion of wave theory the average uninitiated person finds. With reference to the path of the wave, even though the wave front (first part of the wave) is spherical by the time it has reached a reasonable distance from the transmitting antenna, the portion of the wave we intercept with our antennas is assumed to be a straight flat plane. If the wave is traveling toward us in a straight line the wave front is at right angles to the direction of travel. Look at a wall. The line to the wall (or move exactly from the wall to you) is the wavepath, and the wall is the wave front. If you were an antenna with your plane parallel to the wavefront, you would be turned so that the wave front would hit both arms at the same time, if the wall (wave front) went over you (the antenna).

(f) Plane perpendicular to the wave front (Figure 2-3). The loop antenna has been turned so that the incoming wave strikes one vertical arm before it strikes the other. If the antenna face is at the true perpendicular the voltages in use in the receiver are strongest, because the differences in the voltages in the opposing arms of the loops are greatest. This is because the wave will be at different intensities (strengths) for each arm of the loop.

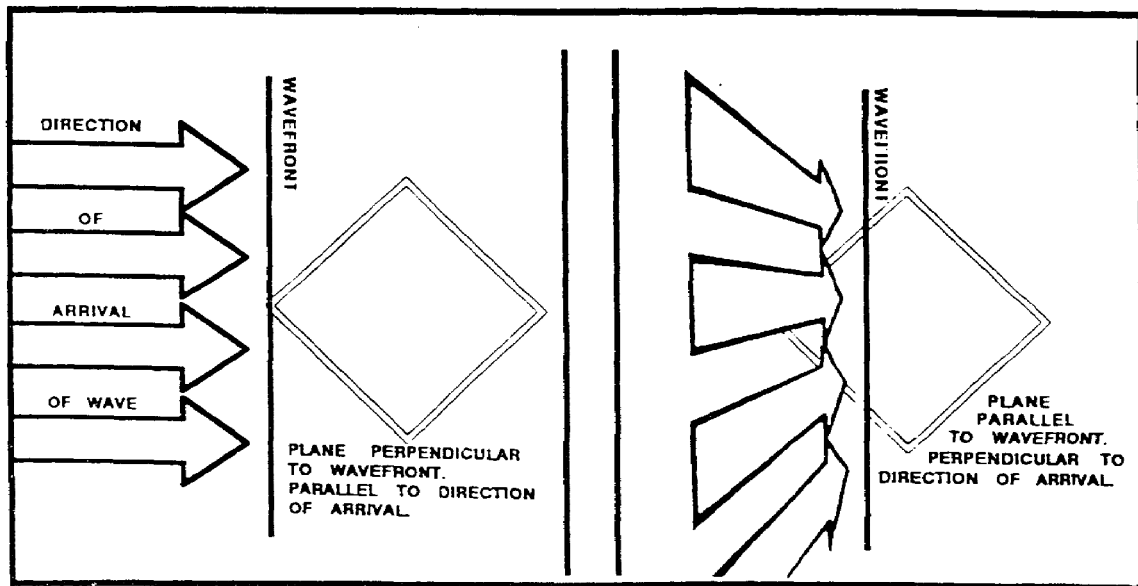

Figure 2-3. Plane perpendicular to the wave front.

(g) Spacing. The physical distance between the antenna elements. Spacing is usually measured in terms of the wavelength, which means that any antenna which is spaced properly for one frequency will not necessarily be spaced properly for another. Spacing is one of the principal limiting factors in determining the frequency range of a directional antenna.

(h) Sense. The addition of an equal voltage from another antenna to the response of a directional antenna. If the voltage added is equal to the original voltage the response pattern is changed to move the nulls to different places in the pattern. Because of this, it is possible to determine from which direction the signal is arriving.

(i) Response pattern. If a target transmitter were physically moved around an antenna, putting out the same amount of signal all the way around a circle at a fixed distance from the center of the antenna, the amount of signal received would vary according to the type of antenna being measured. If this variation is recorded on circular graph paper as so much volume equals so many lines on the graph, with a relationship between direction on the paper and direction in the field, a pattern results which indicates the response of the antennas at any direction. The whip antenna has a circular (omnidirectional) pattern.

(j) Omnidirectional. The response pattern of (for example) the whip antenna. All directions produce an equal response.

(k) Null. The point of weakest response or ideally no response. If the equipment is sensitive enough to allow critical measurement the system is said to have deep nulls. A system with broad nulls does not meet the accuracy requirements of today's direction finding systems (Figure 2-4).

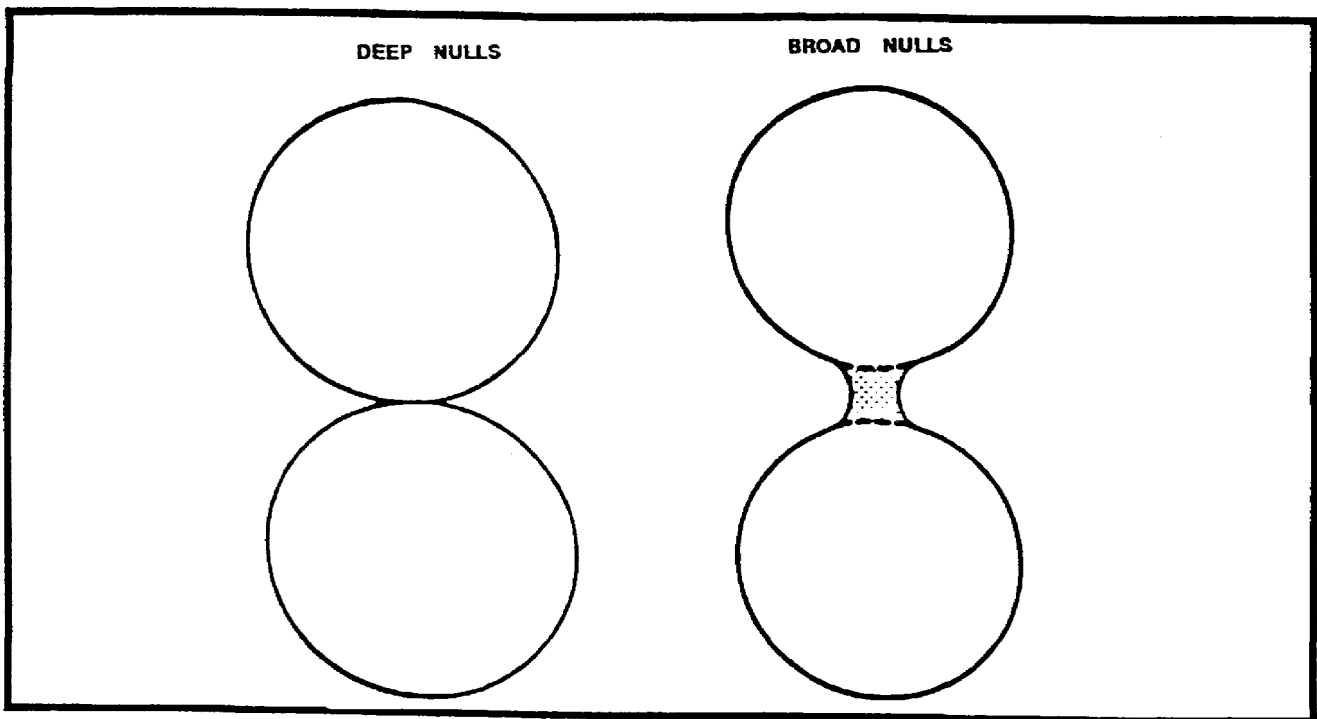

Figure 2-4. Deep nulls and broad nulls.

PART C: REQUIREMENTS

1. The principal antennas used in direction finding are the loop (Figure 2-5), crossed loop (Figure 2-6), Adcock (Figure 2-7), crossed Adcock (Figure 2-8), and circularly disposed antenna arrays (CDAA, Figure 2-9). Each has directional properties, and can be used with direction finding sets to meet specific requirements. Your studies in wave propagation, and definitions of terms used in antenna theory should have given you the terms you will need to understand the following discussion.

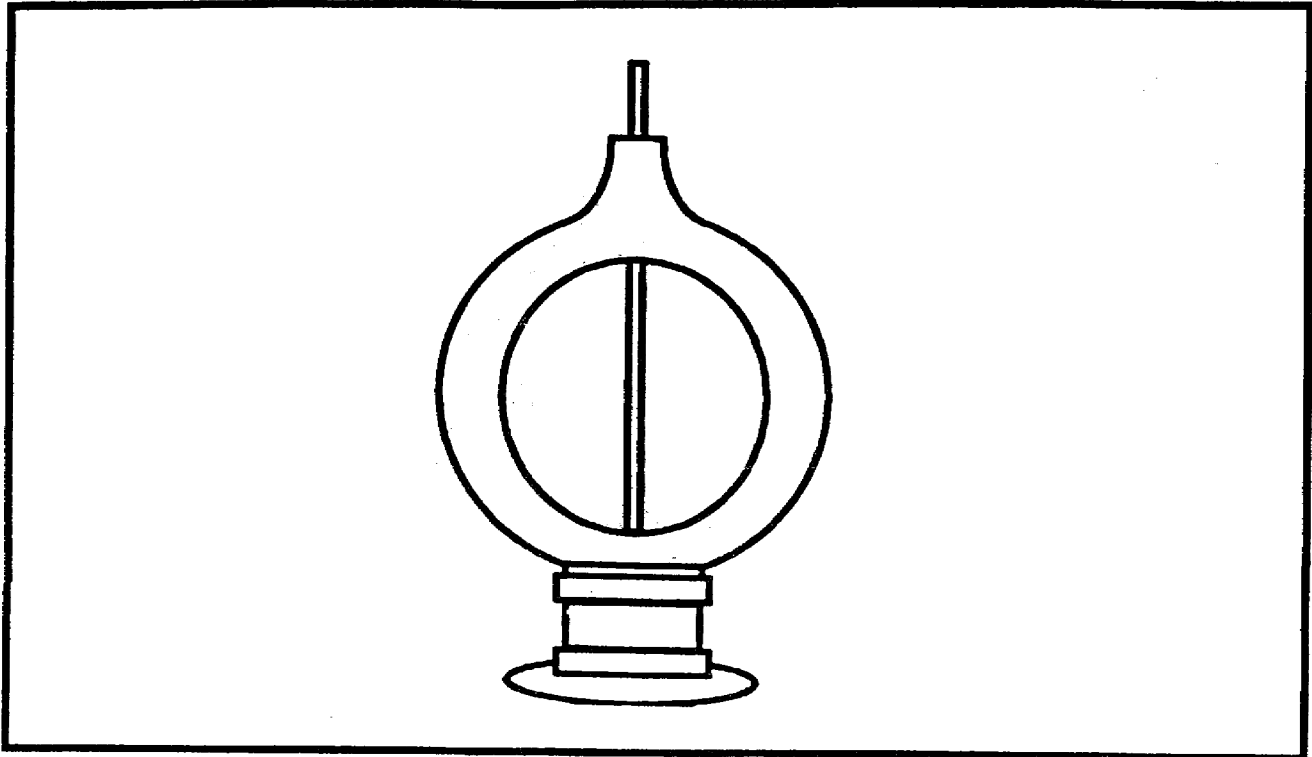

Figure 2-5. Loop Antenna.

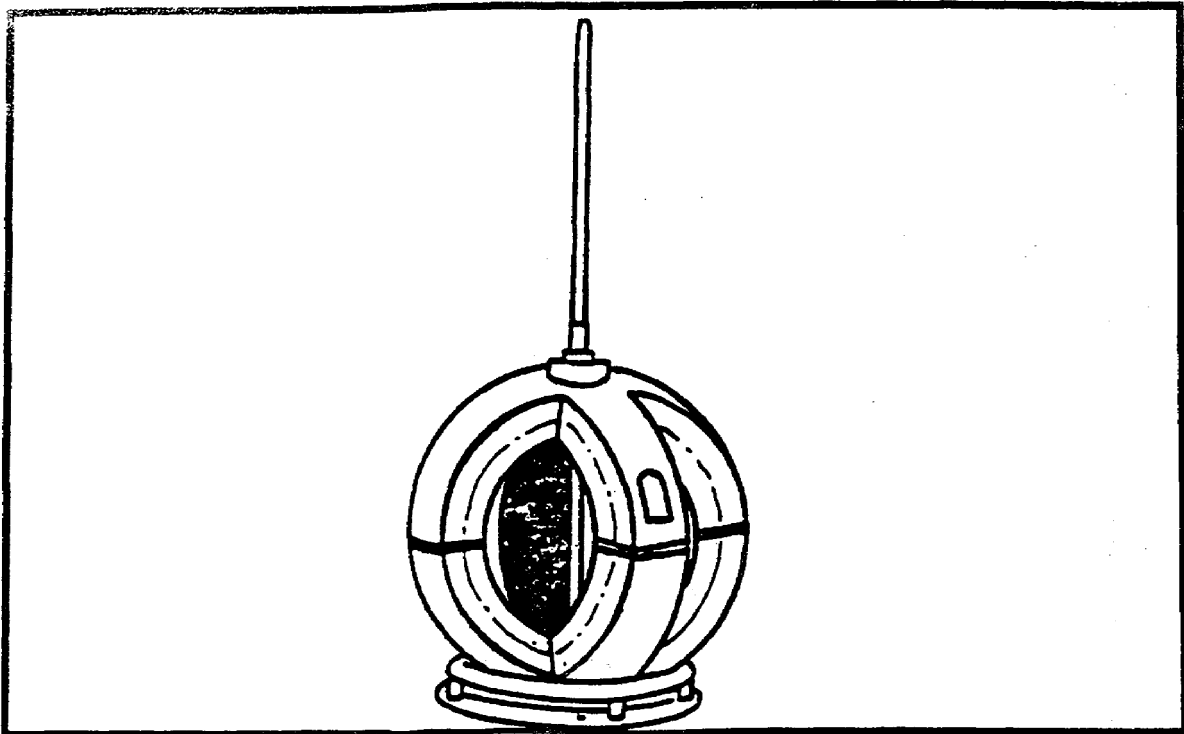

Figure 2-6. Crossed loop antenna.

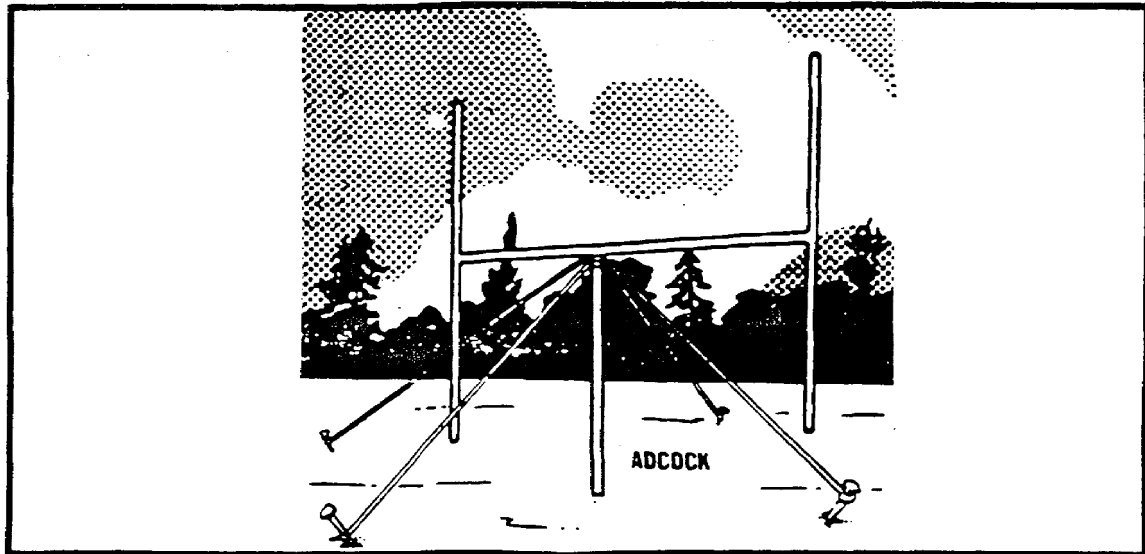

Figure 2-7. Adcock antenna.

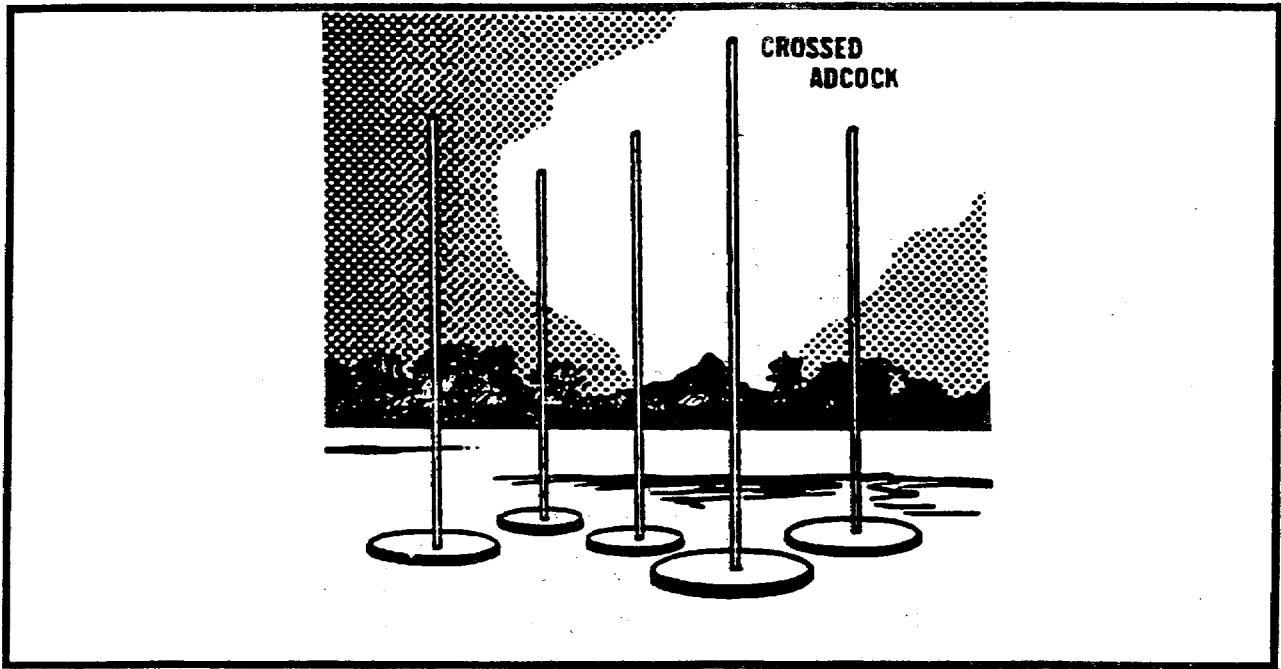

Figure 2-8. Crossed adcock antenna.

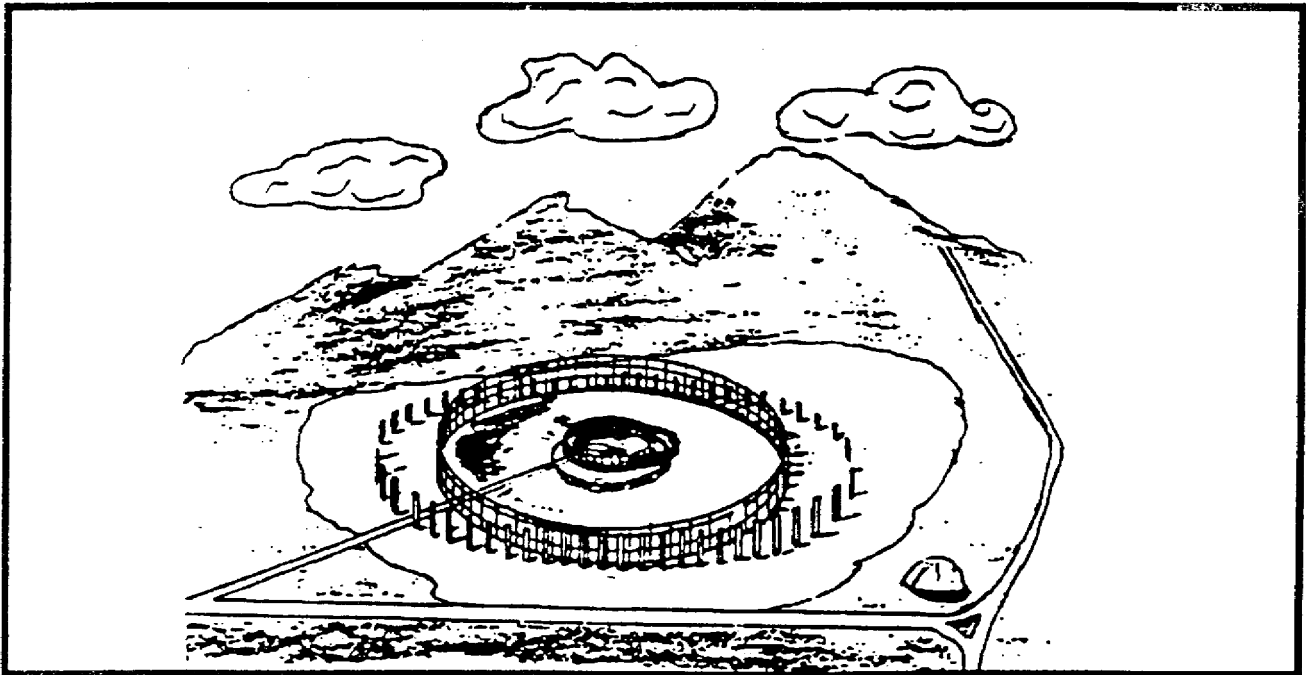

Figure 2-9. Circularly disposed antenna array.

Loop antennas are as old as radio itself. Hertz used them in the original experiments demonstrating transmission and reception, and their directional properties were known long

before there were enough transmitters to make direction finding worthwhile, A loop antenna consists of one or more turns of conductor, either self supporting or wound on a frame. The most common are diamond, square or circular loops (Figure 2-10).

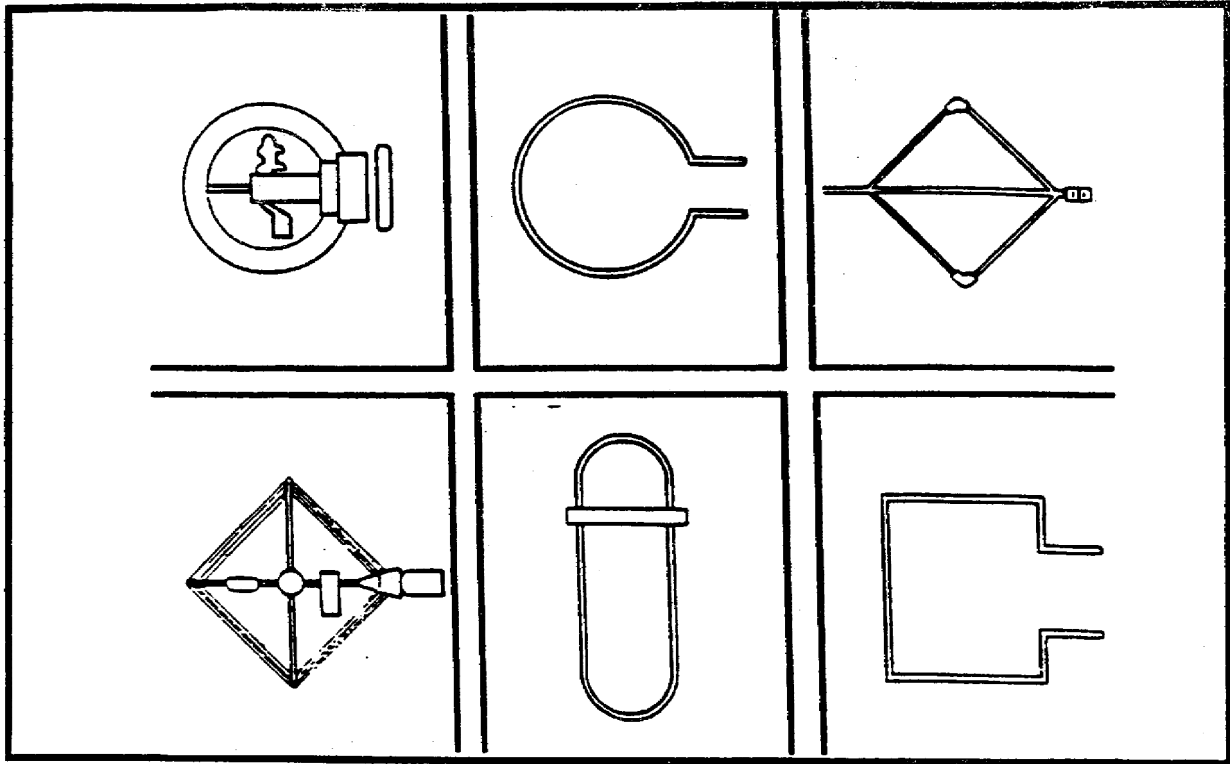

Figure 2-10. Variation of Loop Antennas.

Imagine a loop placed in the path of a vertically polarized wave and turned so that a line from side to side of the loop is parallel (plane perpendicular to the wave front) to the direction of the wave. (Refer to Figure 2-3). Since polarization is discussed in terms of the electric field, the magnetic field of a vertically polarized wave is horizontal. This horizontal magnetic field induces voltage in the loop's vertical arms and in the horizontal arms, since the wave travels parallel to them. The two voltages induced into the vertical arms tend to partially cancel across the antenna, but only partially, since the simultaneous voltages are different. This causes a voltage according to the size of the wave, or put more technically, a voltage is developed which has a magnitude relative to the field intensity of the wave. If the loop is rotated until it is broadside (plane parallel to the wave front) to the oncoming wave the voltages induced in the arms are equal and in phase with each other and cancel across the coupler to give a minimum response, or null. Two null points are present in a loop, 180 degrees apart, giving the antenna a response pattern shaped like a figure eight. (See Figure 2-11).

Unless the general direction of the transmitter is known, a direction finder equipped with a single loop cannot determine whether the transmitter lies forward or to the rear of the direction finder. There is no indication as to which of the two nulls indicates the true direction. From the previous lesson you may remember that this is known as the **BIDIRECTIONAL AMBIGUITY**, and solving the problem is known as resolving the bidirectional ambiguity. A sense antenna,

usually a whip, is placed at the center axis of the loop, and the two response patterns are electrically combined to produce an unbalanced pattern (cardioid, or heart-shaped) which can be used to resolve the bidirectional ambiguity.

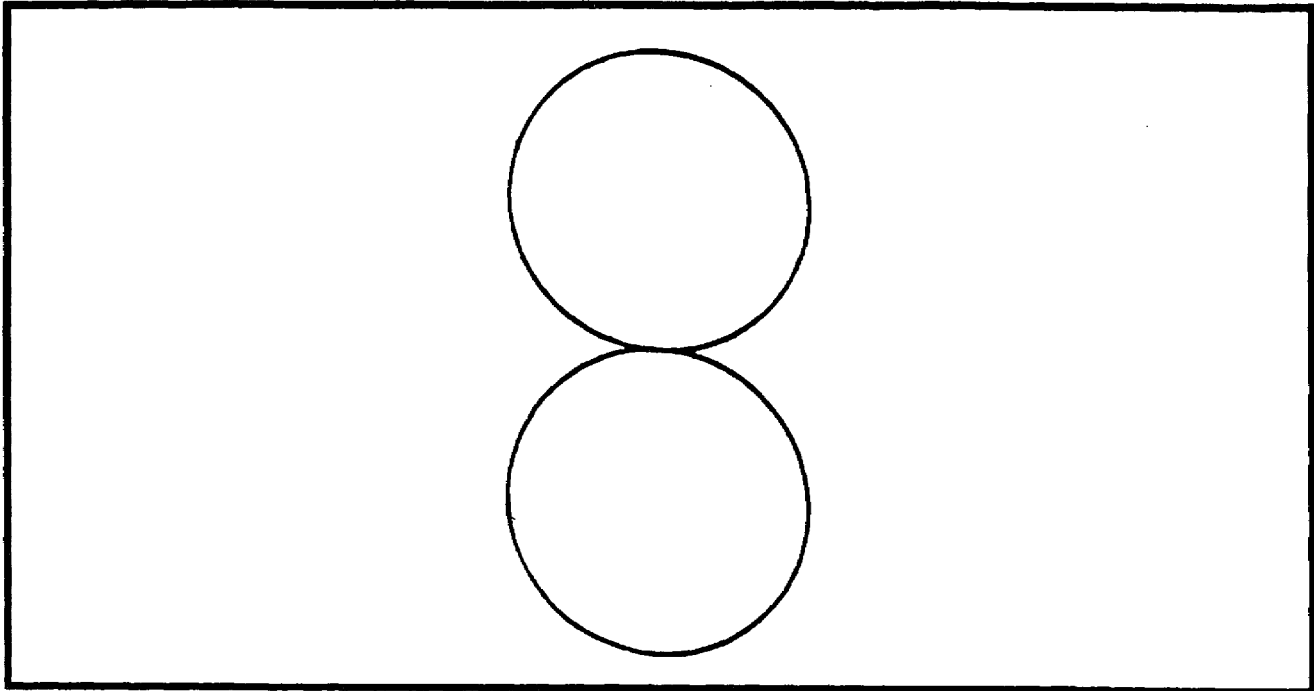

Figure 2-11. Two null points.

The crossed loop antenna consists of two loops with identical characteristics mounted at right angles to each other. Each loop has a figure eight pattern, but the two patterns are displaced 90 degrees in azimuth. As a result, the ratio of the two responses varies with direction. The outputs of the two antennas are connected through a coupler which can be rotated to find the null. This coupler is called a goniometer or a rotary coupler. Since the loops themselves are not rotated they can be made quite large for increased sensitivity. Loop and crossed loop antennas are subject to large polarization errors.

An adcock antenna consists of two spaced vertical antennas connected in opposition (one to each side of a coil). An example of a common type of Adcock is shown in Figure 2-12. In theory it responds only to the vertically polarized wave and, therefore, is not subject to polarization error. In practice there is some polarization error, but usually much less than in a loop receiving the same signal. The Adcock is preferable when medium or high frequency signals must be received at a point beyond ground wave range.

The action of the antenna, as far as vertically polarized waves are concerned, is identical with that of the loop. A resultant current in the output coil is proportional to the difference of the voltages induced in the vertical members, exactly as in the loop. Horizontally polarized components of the incoming signals do not affect the antenna because of the absence of upper and lower horizontal members and because the crossed arrangement of the center

members effectively cancels the voltage induced in them. The response pattern is the same figure eight as the loop antenna.

Both the loop and Adcock antenna have polarization errors when the incoming wave is horizontally polarized, but so long as the vertical polarization is predominant the Adcock is

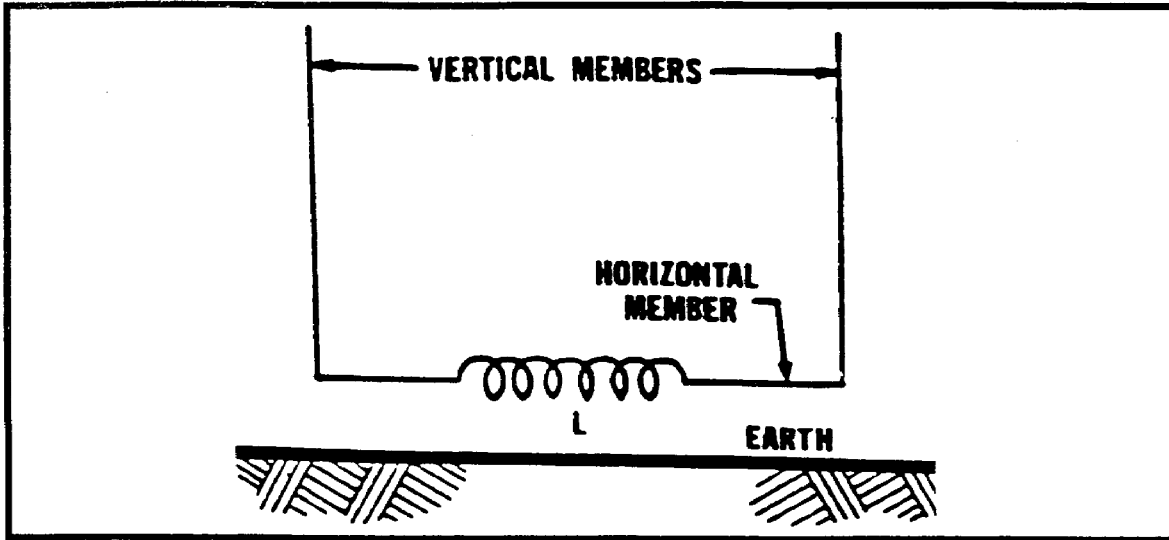

Figure 2-12. Example of adcock antenna.

relatively free from polarization error. The Adcock antenna also requires a sense antenna to resolve the bidirectional ambiguity.

The crossed Adcock antenna consists of two identical Adcock antennas oriented 90 degrees apart in azimuth. At low or medium frequencies crossed Adcock antennas can be made much larger than rotatable Adcocks and are, therefore, much more sensitive. At high frequencies this advantage is small because of the limitations imposed by spacing (OCTANTAL ERROR).

In a crossed Adcock system the maximum spacing is $1/2$ wavelength between antennas (.707 wave length between diagonally spaced antennas). Above this limit the same indication may be obtained for signals coming from three different directions. (Six before sensing). Above approximately half this absolute limit the correction of octantal errors is necessary for almost every azimuth reading taken, and the nominal top frequency is usually set at this point.

Circularly disposed antenna arrays (CDAA) are the largest installations sometimes several areas in size requiring special coupling and sensing devices in order to present a directional pattern on a visual display system. (Refer to Figure 2-9) While the systems are both accurate and sensitive, direction finding is not their primary purpose.

Interferometric systems are a completely different class of direction finding systems (as illustrated in Figure 2-13). The azimuth of an incoming wave is not deduced by rotating beams. It is taken from the phase measurements of signals, made on a number of spaced antennas. Unlike the beam-forming type of WADFs, interferometers accept all signals on the

array. Two different approaches are used to process the results. Depending on the type of system, one or both of the following may be used:

- Wavefront analysis (WFA).
- Wavefront testing (WFT).

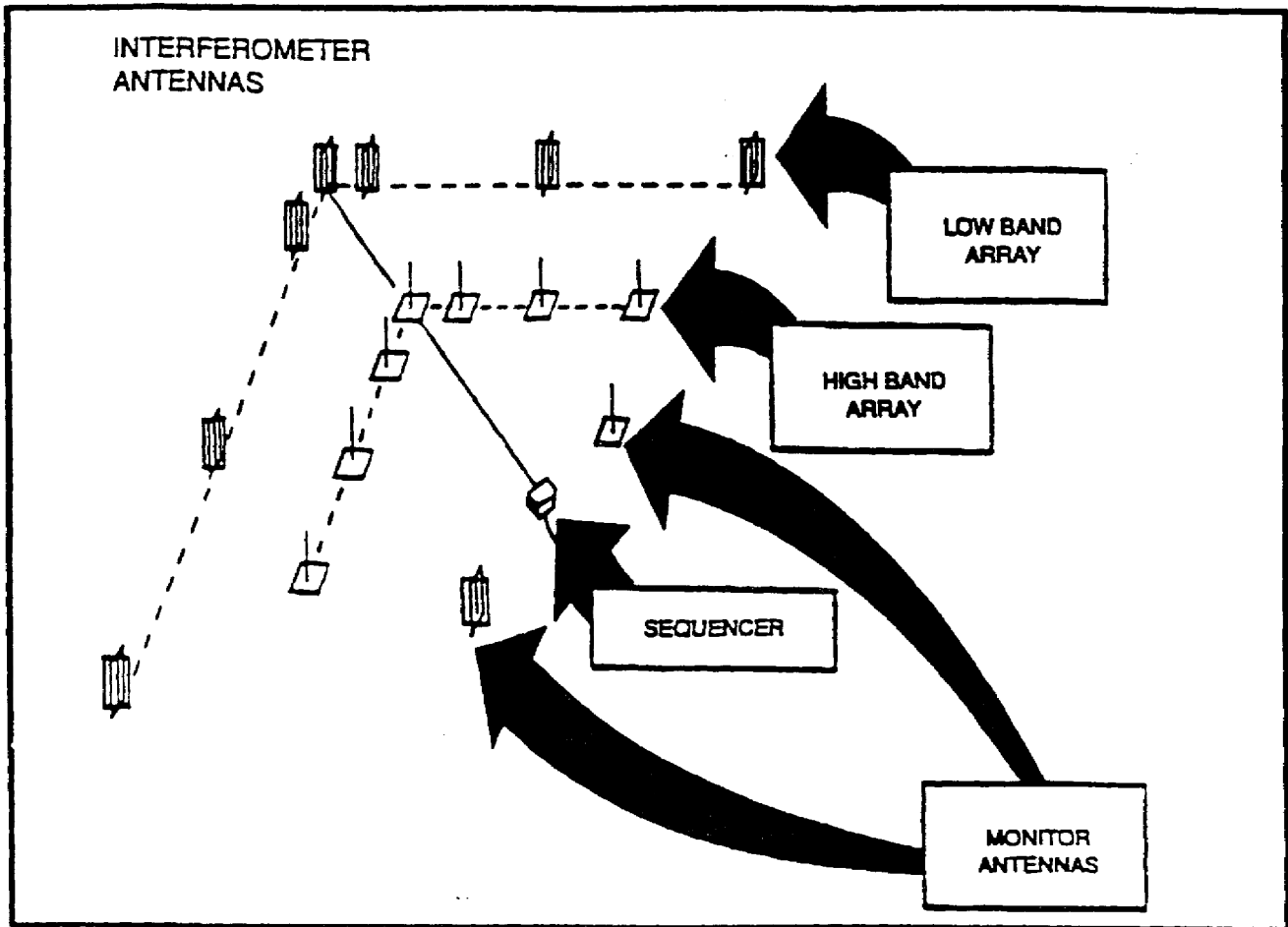

Figure 2-13. Interferometric system.

Wavefront analysis accepts all signals but attempts to recover the major ones. It attempts this by analyzing the complex voltages measured on the elements of the antenna array under wave interference conditions.

Wavefront testing accepts only signals arriving from one direction or quasi uni-modal propagation (QUMP). QUMP is achieved by detecting a linear phase shift across the array with near equal amplitudes on all the elements. (This process is also called coincidence interferometry.)

The requirements for an efficient coupling system for DF are simple, and there are several types in use, some more complex than others, but all categorized into two groups;

- (1) Systems used with fixed antennas.
- (2) Systems used with rotatable antennas.

The requirements for coupling systems are:

- (1) The system must efficiently conduct the energy picked up by the antenna to the radio. If this requirement is not met the direction finder will lack sensitivity.
- (2) It must not pick up or otherwise add additional energy from the wanted signal. Failure to meet this requirement results in bearing errors.
- (3) It must not introduce unwanted signals or noise. These effects, if present, produce interference and impair the bearing readability.

With rotatable antennas the two most common types of coupling are DIRECT, and TRANSMISSION LINE.

Direct coupling is the simplest form of coupling, directly coupling the antenna terminals to the receiver input. It is used in those few cases where it is practicable to design a DF system in which the radio receiver is located at the antenna terminals, and the antenna and receiver rotate together as a unit. Some directly coupled DF sets are small, hand-carried, transistorized receiving sets used by counterinsurgency personnel. The loop is generally the carrying handle, and the entire set is rotated to produce line bearings in the direction of the target transmitter.

Transmission line coupling is used in its simplest form when the antenna system is placed some distance above, but is rotatable with, the DF receiver. Because of its length and position the transmission line will, if its shielding or balance are not perfect, introduce unwanted energy, causing bearing errors or impaired readability. Additionally, if the length of the transmission line is an appreciable fraction of a wavelength or more, its characteristic impedance must accurately match the impedance of the receiver and the antenna, or a considerable loss of sensitivity will occur.

The direct and transmission line systems of coupling the antenna to the receiver may be used when it is desired to rotate the antenna without rotating the receiver. This is accomplished by adding a rotatable coupling element. Some of these elements are:

- (1) Slip rings. These are insulated metal rings in contact with sliding fingers or brushes, which permit rotation without interrupting the circuit. By mounting the rings on a shaft and providing fixed brushes, it is possible to conduct the antenna current to a stationary receiver while permitting the antenna to turn at will.
- (2) Rotating transformer. This rotatable coupling device consists of a transformer whose primary and secondary windings are coaxial. Under this condition one winding may be rotated with respect to the other without changing the coupling which exists between them.

(3) Rotating capacitor. This element makes use of the fact that the capacitance between coaxial rings or discs is independent of their rotation.

IT0302

2-14

Fixed antennas use some form of goniometer. The term goniometer is applied to a device used to couple two or more input circuits (usually connected to antennas) to an output circuit (usually connected to the receiver). This is done in such a manner that the degree of coupling varies with the rotation of a shaft. The coupling between one input circuit and the output circuit decreases while the coupling with the other input circuit increases. When properly connected, a well constructed goniometer provides an output at each position of its shaft identical to that which would be produced by a single figure-eight pattern antenna oriented to the corresponding position. Thus, the goniometer provides an equivalent for the rotation of an antenna, and makes it possible to use large fixed antenna systems (either loop, Adcock, CDAA, or others) which would be too bulky for an operator to rotate.

Goniometers must meet these basic requirements:

- (1) The fixed elements must be electrically identical.
- (2) There must be a complete absence of coupling between the fixed elements.
- (3) Accurate positioning of the fixed elements at the same angle as the antennas (usually 90 degrees) is necessary.
- (4) Coupling between the rotating element and the fixed elements must vary with shaft revolution in the same manner as the variation of antenna response with azimuth angle. These requirements are met in practical goniometers to the extent that the maximum error is less than plus or minus one degree.

In applying to the goniometer to a practical direction finder, it is often desirable to locate the goniometer some distance away from the antenna. To accomplish this, it is necessary to provide transmission lines between the antenna and its goniometer. These lines must be well shielded and are usually balanced to ground to avoid stray pick-up. Additionally, the transmission lines connecting the several antennas to the goniometer must be electrically identical, particularly in time delay, over the entire frequency range of the equipment in order to preserve accuracy and provide deep nulls.

The principal types of goniometers are:

- (1) Inductive, usually consisting of two fixed windings at right angles to each other and enclosing a third winding which rotates on a shaft.
- (2) Capacitive, with two fixed sets of plates enclosing a rotatable set of plates, and
- (3) Electronic, which utilizes circuitry instead of physical rotation, and, therefore, allows higher speeds than can be obtained by mechanical rotation.

The use of a goniometer introduces an additional possibility for octantal error above that caused by antenna spacing. This is caused by nonuniformity within the electric fields of the stationary windings of the goniometer. In early days this nonuniformity was considerable, and octantal error was large. In more modern goniometers, the windings are distributed in such a manner that this cause of octantal error is practically eliminated. The octantal error is

caused by antenna spacing still exists, usually requiring a correction chart for the higher ranges o the equipment.

2. The type of bearing **indicator** used with any particular direction finder depends on the type of DF system in use, the complexity and physical size permitted, and the accuracy desired for a particular DF application. Many types of bearing indicators have been designed and used in DF systems, but those having the greatest application can be grouped into the categories of AURAL indicators and VISUAL indicators. Visual indicators can be further grouped into three subelements, left-right indicators, instantaneous indicators, and automatic bearing seeking indicators. Each type of indicator has certain specific characteristics and applications. Many of these characteristics are closely related to, and cannot be separated from, characteristics of the type of DF system with which a particular indicator is used. Therefore, keep in mind that some of the characteristics credited to a specific indicator are really characteristics of the DF system with which the indicator is used.

Aural Indicators. An aural indicator is a headset or loudspeaker connected to the DF receiver audio circuit. It enables the operator to detect the bearing of a signal by changes in audible receiver output as the antenna is rotated. In DF systems which use aural indicators, the antenna system must be able to be rotated to the bearing position, and this position must be characterized by an abrupt change in the antenna response pattern, and, therefore, in the receiver output.

In most common direction finders which use an aural indication the antenna is a rotatable loop or Adcock, or a fixed crossed-loop or crossed-Adcock effectively rotated by a goniometer. All these antennas have, or result in, a figure-eight response pattern with broad maxima and sharp nulls. Therefore, the nulls of the system are selected as the bearing points. Because of this, these systems are called aural-null indicators. At higher frequencies (several hundred megahertz) directional arrays having response patterns with sharp maxima can be used. Because aural-null systems are more common we will not discuss aural-maxima systems further.

The most important characteristics of an aural-null indicator are:

- (1) It is the simplest indicator that can be used with a direction finder for the following reasons;
 - (a) it adds nothing to the direction finder because a headset or loudspeaker is usually included for monitoring purposes.
 - (b) it can be used with simple loop or Adcock antenna systems without the addition of complicated couplings.
 - (c) it reduces to a minimum the size, weight, and maintenance factors of the indicator.
 - (d) it is simple to use, even by unskilled operators.
- (2) Because it does not necessitate the use of complicated and elaborate antenna, coupler, and receiving systems, the sensitivity and instrumental accuracy of the direction finder is high.

(3) The indicator cannot detract from the accuracy inherent in the remainder of the system.

(4) The readability of the indicator is not influenced by the type of signal received, whether it is continuous wave (cw), interrupted continuous wave (icw, or modulated continuous wave (mcw). Readability shows how the indicator can detect relatively small changes.

(5) The readability of the indicator is high on weak signals in the presence of noise or interference signals because the human ear can distinguish between desired and undesired signals.

(6) The readability is poor on fading signals because it cannot discriminate between a fade and a null indication.

(7) The readability of the indicator is poor on swinging signals because the antenna cannot be rotated fast enough to follow the swinging bearing. A swinging signal is one that because of propagation errors seems to move back and forth through several degrees of arc.

(8) An extra operation must be performed to determine which of the two directions indicates the correct azimuth (sensing).

3. Visual indicators. Visual indication has been accomplished through various means. Each has the common characteristic of operation by comparison of antenna voltages. These voltages may originate from any of several antennas. Among the types of visual indication are left-right meter, crossed pointer meter, magic eye, matched line oscilloscopes, and instantaneous oscilloscope indicators. Because the instantaneous indicators are most common this lesson will limit itself to them.

An instantaneous indicator, using a cathode ray tube, continuously and automatically presents on the tube screen a pattern or trace that points toward the azimuth of the arriving signal as read from an azimuth scale situated around the tube face. The presentation of this pattern is accomplished without manually rotating the DF antenna to the bearing point.

The antenna system must be one of the following types:

(a) It may be a fixed oriented, crossed loop or crossed Adcock variety and effectively rotated through 360 degrees at some continuous and constant rate by a spinning mechanical goniometer or electric goniometer method.

(b) The antenna system may be a single-loop or Adcock that is continuously rotated by mechanical means at a constant rate through 360 degrees.

(c) The antenna system may be of the fixed oriented, crossed loop or crossed Adcock variety and the output of each of the antennas must be maintained as separate signals through individual channels in the indicator.

(d) The antenna may be of the CDAA type and employ either antenna switching or goniometers to effectively rotate the antenna through 360 degrees at a constant rate.

Because these special features must be incorporated in a DF system using instantaneous indicator, its size, weight, power consumption, complexity of design, and maintenance are greater than for other systems. When not prohibitive, these disadvantages are more than compensated for by the increased performance obtained when using this type of indicator. Characteristics of instantaneous indicators in comparison with aural-null are as follows:

- (a) There is greater speed in obtaining bearings because the antenna is usually not rotated.
- (b) Simplicity of operation is increased. Tuning the receiver and reading the bearing are the only operations necessary.
- (c) Readability is increased on moderate and weak signals.
- (d) There is equal readability on cw, icw, and mcw signals.
- (e) Readability on swinging signals is increased because the indication continuously and instantaneously changes with the bearing swing, thus enabling the operator to choose the most likely bearing.
- (f) Readability on fading bearings is increased because the indicator has a high degree of discrimination between a change in signal level due to fade, and a change in bearing and signal indication.
- (g) There is increased readability on combinations of swining, fading and unfavorably polarized signals, because the indicator exhibits certain features which tell the operator when conditions are most favorable for obtaining a bearing.
- (h) Sense indication may be simultaneous with the presentation (continuously sensed) or it may be accomplished by pressing a key (sense switch).
- (i) Readability in the presence of interfering signals is fair, although not as good as with aural indication.

4. Bearing seeking indicators. Bearing seeking indicators are normally used on aircraft where an automatic bearing readout is required but size and weight requirements preclude the use of Instantaneous visual indication. In these systems the antenna system is rotated automatically to the true bearing position and a pointer on the indicator comes to rest when it is aligned with the antenna.

LESSON 2

PRACTICE EXERCISE

The following items will test your grasp of the material covered in this lesson. There is only one correct answer for each item. When you have completed the exercise, check your answers with the answer key that follows. If you answer any item incorrectly, study again that part of the lesson which contains the portion involved.

1. Including a receiver, what are the other basic equipment requirements needed for a DF system?
 - A. Aural Null, Visual Indicator, and a Coupler
 - B. Aural Null, Visual Indicator, and a Directional Antenna
 - C. Coupler, Indicator, and a Directional Antenna
 - D. Coupler, Indicator, and a Secondary Receiver
2. Besides stability and selectivity, what else must a DF receiver have?
 - A. BFO, and Headsets
 - B. BFO, and Sensitivity
 - C. Sensitivity, and Headsets
 - D. Sensitivity, and Frequency Range
3. What device connects the antenna to the receiver?
 - A. Coupling
 - B. Goniometer
 - C. Frequency Modulator
 - D. Antenna Modulator
4. What is an example of a visual indicator for the null?
 - A. Goniometer
 - B. Crossed Pointer
 - C. Loudspeaker
 - D. Cathode Ray Tube
5. DF equipment comes in several sizes. What are the specific requirements dictated by?
 - A. The Mission
 - B. The Cost
 - C. The Location
 - D. Transportation Capabilities

6. What part of the DF receiver is used to give a steady tone for ease of direction finding/AM signals?
 - A. Aural Null
 - B. BFO
 - C. AM Modulator
 - D. FM Modulator

7. What device is used to electrically rotate an antenna?
 - A. Slip Rings and Brushes
 - B. Goniometer
 - C. Direct Coupling
 - D. Cathode Ray Tube

8. Which is the simplest form of coupling?
 - A. Transmission line
 - B. Rotating
 - C. Direct
 - D. Indirect

9. Which antenna requires an additional sense antenna?
 - A. Loop
 - B. Adcock
 - C. Both Loop and Adcock
 - D. Neither Loop no Adcock

10. What is the most common type of visual indicator?
 - A. Left-Right Meter
 - B. Crossed Pointer Meter
 - C. Oscilloscope Indicator
 - D. Instantaneous Indicator

LESSON 2

PRACTICE EXERCISE

ANSWER KEY AND FEEDBACK

<u>Item</u>	<u>Correct Answer and Feedback</u>
1.	C. (page 2-2)
2.	B. (page 2-4)
3.	A. (page 2-3)
4.	D. (page 2-4)
5.	A. (page 2-1)
6.	B. (page 2-4)
7.	B. (pages 2-3/2-4 and 2-15)
8.	C. (page 2-14)
9.	B. (page 2-12)
10.	D. (page 2-17)